

SPACEFLIGHT REVOLUTION

NASA Langley Research Center
From Sputnik to Apollo

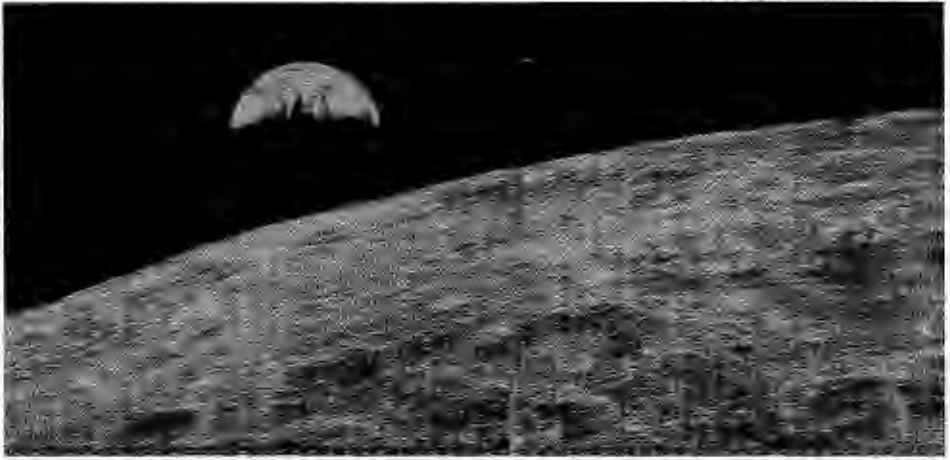

SPACEFLIGHT REVOLUTION



L-66-6399

The “picture of the century” was this first view of the earth from space. Lunar Orbiter I took the photo on 23 August 1966 on its 16th orbit just before it passed behind the moon. The photo also provided a spectacular dimensional view of the lunar surface.

NASA SP-4308

SPACEFLIGHT REVOLUTION

NASA Langley Research Center
From Sputnik to Apollo

James R. Hansen

The NASA History Series



1995
National Aeronautics and Space Administration
Washington, DC

NASA maintains an internal history program for two principal reasons: (1) Sponsorship of research in NASA-related history is one way in which NASA responds to the provision of the National Aeronautics and Space Act of 1958 that requires NASA to “provide for the widest practicable and appropriate dissemination of information concerning its activities and the results thereof.” (2) Thoughtful study of NASA history can help agency managers accomplish the missions assigned to the agency. Understanding NASA’s past aids in understanding its present situation and illuminates possible future directions. The opinions and conclusions set forth in this book are those of the author; no official of the agency necessarily endorses those opinions or conclusions.

On the cover: Langley’s innovative Little Joe rocket streaks into space from its launchpad at Wallops Island, Virginia, on 4 October 1959, two years to the day after the historic first orbit of the Soviet Sputnik 1.

Library of Congress Cataloging-in-Publication Data

Hansen, James R.

Spaceflight revolution : NASA Langley Research Center from
Sputnik to Apollo / James R. Hansen.

p. cm. — (NASA history series) (NASA SP ; 4308)

Includes bibliographical references and index.

1. Langley Research Center—History. 2. Astronautics—United
States—History. I. Title. II. Series. III. Series: NASA SP ; 4308.

TL521.312.H36 1995

629.4’0973—dc20

94-24592

CIP

Contents

Illustrations	ix
Foreword	xv
Acknowledgments	xvii
Prologue	xxv
1. The Metamorphosis	1
The Venerable Order of the NACA	3
Glennan: Welcome to NASA	11
Air versus Space	15
The Public Eye	22
2. The First NASA Inspection	27
Following the NACA Way	33
Project Mercury	37
Big Joe, Little Joe	46
3. Carrying Out the Task	51
A Home at Langley	55
The Tracking Range	63
Shouldering the Burden	69
The End of the Glamour Days	76
4. Change and Continuity	81
The Organization	85
Thompson's Obscurantism	91
The Sinking of Hydrodynamics—and Aeronautics?	93
Growth Within Personnel Ceilings	102
The Shift Toward the Periphery	107
Contracting Out	109
The Brave New World of Projects	112
Uncharted Territory	117
5. The "Mad Scientists" of MPD	121
The ABCs of MPD	121
The Solar Wind Hits Home	122
The MPD Branch	126

Spaceflight Revolution

Out of the Tunnel	132
Into the Cyanogen Fire	138
The Barium Cloud Experiment	142
The Search for Boundless Energy	147
A Hot Field Cools Off	150
6. The Odyssey of Project Echo	153
The International Geophysical Year and the V-2 Panel	156
O'Sullivan's Design	159
Extraterrestrial Relays	162
Finessing the Proposal	164
The "Sub-Satellite"	166
Something the Whole World Could See	170
Big Ideas Before Congress	175
Assigning Responsibilities	177
Shotput	179
A Burst Balloon	185
"Anything's Possible!"	187
Reflections	189
The Hegemony of Active Voice	193
7. Learning Through Failure: The Early Rush of the Scout Rocket Program	197
"Itchy" for Orbit	197
Little Big Man	200
Little Foul-Ups	205
"3-2-1 Splash"	209
Recertification	214
An Unsung Hero	216
Postscript	219
8. Enchanted Rendezvous: The Lunar-Orbit Rendezvous Concept	221
Brown's Lunar Exploration Working Group	222
Michael's Paper on a "Parking Orbit"	226
The Rendezvous Committees	230
Houbolt Launches His First Crusade	233
The Feelings Against LOR	237
The Early Skepticism of the STG	241
Mounting Frustration	245
President Kennedy's Commitment	248
Houbolt's First Letter to Seamans	249
A Voice in the Wilderness	257
The LOR Decision	260
Postscript	267

9. Skipping “The Next Logical Step”	269
“As Inevitable as the Rising Sun”	271
The First Space Station Task Force	274
From the Inflatable Torus to the Rotating Hexagon	277
Betwixt and Between	286
Manned Orbital Research Laboratory	293
Keeping the “R” Alive	301
Understanding Why and Why Not	305
Lost in Space?	307
10. To Behold the Moon: The Lunar Orbiter Project	311
The “Moonball” Experiment	315
Initiating Lunar Orbiter	319
Project Management	321
The Source Evaluation Board	326
Nelson’s Team	332
The Boeing Team	334
The “Concentrated” versus the “Distributed” Mission	336
“The Picture of the Century”	344
Mission More Than Accomplished	346
Secrets of Success	350
11. In the Service of Apollo	355
Langley’s “Undercover Operation” in Houston	357
The Dynamics of Having an Impact	361
Inside the Numbers	366
The Simulators	369
Rogallo’s Flexible Wing	380
The Apollo Fire Investigation Board	387
12. The Cortright Synthesis	393
The Stranger	394
The Reorganization	401
New Directions	413
Critique from the Old Guard	418
Epilogue	427
Abbreviations	441
Notes	447
Index	519
The Author	537
The NASA History Series	539

Illustrations

Earth as photographed by <i>Lunar Orbiter I</i> , 1966	ii
Dwight D. Eisenhower, 1958	3
Map of Tidewater Virginia, 1930s	5
Floyd L. Thompson	6
Langley Aircraft Manufacturers' Conference, 1934	6
NACA Main Committee, 1929	8
Henry J. E. Reid, Vannevar Bush, and George W. Lewis	9
George W. Lewis and Hugh L. Dryden	11
T. Keith Glennan, 1958	13
T. Keith Glennan and Henry J. E. Reid, 1959	14
NACA test pilot Paul King, 1925	16
Variable-Density Wind Tunnel, 1922	18
Bell P-59 Peashooter in Full-Scale Tunnel, 1944	18
Swallow arrow-wing model in 16-Foot Transonic Tunnel, 1959	21
X-15 model in 7 × 10-Foot High-Speed Tunnel, 1958	21
Aerial photo of Langley, 1950	25
Mercury exhibit at NASA's First Anniversary Inspection, 1959	29
Ira H. Abbott and Henry Reid, 1959	29
T. Keith Glennan and Floyd L. Thompson, 1959	29
Walter Bonney and T. Keith Glennan, 1959	31
Full-size mock-up of the X-15, 1959	32
John Stack and Axel Mattson	35
Goddard's exhibit at NASA's First Anniversary Inspection, 1959	36
Robert R. Gilruth	38
Diagram of Mercury mission concept	39
The Mercury astronauts	40
Molded couches for Mercury capsule	44
Diagram of Mercury capsule	44
John Glenn inside Mercury capsule	45
John Glenn and Annie Castor Glenn, 1959	46
Little Joe capsules constructed in Langley shops	48
Little Joe on the launchpad at Wallops Island	48
Little Joe blasting off from Wallops Island, 1959	49
Little Joe capsule recovered at sea	49
Model of Mercury capsule in Full-Scale Tunnel, 1959	61
Model of Mercury capsule in 7 × 10-Foot High-Speed Tunnel, 1959	61

Spaceflight Revolution

Model of Redstone booster in the Unitary Plan Wind Tunnel, 1959	62
Impact studies of Mercury capsule in the Back River, 1960	62
George Barry Graves, Jr	67
Layout of Project Mercury tracking site	68
John A. "Shorty" Powers, 1962	78
Walter M. Schirra, 1962	78
Robert R. Gilruth and the mayor of Newport News, 1962	79
John Glenn and his wife, Annie, 1962	79
Floyd L. Thompson, 1963	83
Floyd L. Thompson, James E. Webb, and John F. Victory	84
Langley organization chart, 1962	87
Clinton E. Brown, Eugene C. Draley, and Laurence K. Loftin, Jr.	88
Langley's top staff members greet Raymond Bisplinghoff	90
Aerial view of the Full-Scale Tunnel and Tank No. 1, 1959	95
X-20 Dyna-Soar model in Tank No. 2, 1961	96
Aeronautics and Space Work as Percentages of Langley's Total Effort, 1957-1965, table	97
John Stack, 1959	99
Scale model of the General Dynamics F-111A	100
Model of SCAT 15F in Unitary Plan Wind Tunnel	101
Number of Paid Employees at NASA Langley, 1952-1966, graph	103
Paid Employees at NASA Langley as Percentage of NASA Total, 1958-1968, graph	103
Kitty O'Brien-Joyner, 1964	105
Langley's women scientists, 1959	105
Langley's computer complex, 1959	111
Scale model of WS-110A in 7 × 10-Foot High-Speed Tunnel	117
Schematic drawings of the Van Allen radiation belts	124
John V. Becker, 1961	128
The Continuous-Flow Hypersonic Tunnel	128
Macon C. Ellis, 1962	129
Paul W. Huber and Marc Feix	131
Philip Brockman and the MPD-arc plasma accelerator, 1964	134
George P. Wood, 1962	136
The accelerator section of the 20-megawatt plasma accelerator facility	136
Charlie Diggs and an early version of a Hall-current plasma accelerator	137
Langley's Hall-current plasma accelerator, 1965	137
Robert V. Hess, 1962	139
Langley's cyanogen burner	141
Concept for a Mars landing vehicle	151

Illustrations

Failed deployment of Echo test	155
William J. O'Sullivan and his family, 1961	157
30-inch Sub-Satellite	168
Heat test of 30-inch Sub-Satellite	168
Jesse Mitchell, 1958	171
Folded Beacon satellite	174
William J. O'Sullivan and the Beacon satellite	174
William J. O'Sullivan, 1958	175
Walter Bressette and prototype of the satelloon	175
<i>Echo I</i> container	181
Inflation of <i>Echo I</i> in Weeksville, N.C.	182
Edwin Kilgore and Norman Crabill	183
The <i>Echo I</i> team and inflated <i>Echo I</i>	183
Will Taub and James Miller assembling Shotput launch vehicle	184
Shotput ready for launch	184
<i>Explorer 24</i>	192
Pageos satelloon	193
Scout on launchpad, Wallops Island	201
James R. Hall, 1961	203
LTV Scout team, 1967	204
Spectators at Wallops Island rocket launch	206
The first Scout launch, 1 July 1960	207
Scout launch control building, Wallops	208
Scout control room, Wallops	208
Eugene D. Schult, 1963	211
Scout launch, 30 June 1961	212
Scout launch, 1 March 1962	213
Launchpad damaged by Scout, 20 July 1963	213
Vought Astronautics technicians assemble Scout	214
San Marco launch operation	218
San Marco's floating platform	218
Committees Reviewing Lunar Landing Modes, table	225
Clinton E. Brown, William H. Michael, Jr., and Arthur Vogeley, 1989	227
John D. Bird, 1962	229
Sketch "To the Moon with C-1's or Bust"	229
Houbolt's Early Crusades, table	234
Houbolt's Later Crusades, table	240
Early version of a lunar excursion module	243
John C. Houbolt, 1962	244
John C. Houbolt explaining lunar-orbit rendezvous scheme	247
Viewgraph comparing the propulsion steps of the three lunar mission modes	254
Comparative sizes of manned mission rockets	256
Comparison of lander sizes	256

Spaceflight Revolution

George M. Low	259
Wernher von Braun at Langley	264
<i>Life</i> magazine cover featuring the lunar excursion module	266
Rejected <i>Life</i> cover of John C. Houbolt	266
75-foot-diameter rotating hexagon	273
Paul R. Hill and Robert Osborne, 1962	275
Rene Berglund, 1962	278
Early space station configurations	278
Inflation of the full-scale model of the inflatable torus	279
Floyd L. Thompson, James Webb, and T. Melvin Butler with the 24-foot inflatable torus	279
24-foot inflatable torus	280
10-foot-diameter scale model of torus	282
Zero gravity mock-up of the 24-foot-diameter torus	282
Drawing of winning rotating hexagonal configuration	284
Model of rotating hexagon assembled and collapsed	284
Douglas MORL baseline configuration	296
Cross section of interior of Douglas MORL	296
MORL illustration from Douglas manual	298
Test of space station portal air lock	299
William N. Gardner explains model of the MORL	300
MORL-Saturn IB model in 8-Foot Transonic Tunnel	302
Otto Trout, 1966	303
Integrative Life Support System arrives at Langley	304
Integrative Life Support System in Building 1250	304
William N. Gardner, 1966	308
Lunar Orbiter above the lunar surface	314
Associate Director Charles J. Donlan	317
Structural dynamics testing for lunar landing	318
<i>Lunar Orbiter III</i> photo of Kepler crater	318
Israel Taback and Clifford H. Nelson, 1964	323
Eastman Kodak dual-imaging camera system	329
Lee R. Scherer	330
Signing of the Lunar Orbiter contract, 1964	331
Clifford H. Nelson and James S. Martin	333
Floyd L. Thompson and George Mueller, 1966	337
The Lunar Orbiter area of interest	337
Typical flight sequence of Lunar Orbiter	340
Lunar Orbiter with labeled components	343
Final inspection of <i>Lunar Orbiter I</i>	343
<i>Lunar Orbiter I</i> liftoff	344
Lunar Orbiter team displays first photo of the earth from deep space	345
The dark side of the moon	347
The lunar surface, Copernicus crater	348

The lunar surface, Tycho crater	349
The "Whole Earth" as photographed by <i>Lunar Orbiter V</i>	352
Floyd L. Thompson and James E. Webb, 1961	358
Axel Mattson, Robert R. Gilruth, Charles Donlan, and Donald Hewes	361
Impact tests of the Apollo capsule	364
Project Fire wind-tunnel test	367
Number of Langley Research Projects Directly Related to Apollo Program, 1962-1968, table	368
The Langley Rendezvous and Docking Simulator	372
Time-lapse sequence of a docking on the Rendezvous Simulator . . .	372
A pilot eyeballing a rendezvous on the simulator	372
Donald Hewes and William Hewitt Phillips	374
Langley Lunar Landing Research Facility	375
Early LEM used with the Lunar Landing Research Facility	376
LEM control cab, the Lunar Landing Research Facility	376
LEM "in flight" using the Lunar Landing Research Facility	376
Time-lapse sequence of an LEM landing using the simulator	377
Modeled floor of the Lunar Landing Research Facility	377
Walter Cronkite using the Reduced Gravity Walking Simulator . . .	378
Lunar Orbit and Letdown Approach Simulator	380
Francis and Gertrude Rogallo, 1963	382
Test flight of the Parasev	382
Parasev in Langley's Full-Scale Tunnel	386
Floyd L. Thompson and Thomas O. Paine, 1968	388
Gus Grissom in the Rendezvous and Docking Simulator, 1963 . . .	390
Roger Chaffee using the Reduced Gravity Walking Simulator, 1965	390
Neil Armstrong and the staff of the Lunar Landing Research Facility, 1967	392
Cortright appointment announced in the <i>Langley Researcher</i>	396
Langley old guard welcomes Cortright, 1968	398
Edgar M. Cortright, 1970	399
Cortright speaks in the Morale Activities building	399
Organization of Langley, 1970, chart	405
Viking Lander model in Langley wind tunnel, 1970	406
View of Mars from <i>Viking Orbiter 1</i> , 1976	407
The <i>Viking Lander 2</i> on the Martian surface, 1976	407
John E. Duberg, George M. Low, and Edgar M. Cortright, 1970	409
Organization changes announced in the <i>Langley Researcher</i> , 1970 . .	410
Model of the Boeing 737 in the Anechoic Antenna Test Facility . . .	416
Richard H. Petersen in the National Transonic Facility, 1984	417
The National Transonic Facility	417

Foreword

James R. Hansen has impeccable credentials as a thorough, perceptive investigator and writer of technological history. His accomplishments in the field are outstanding, as exemplified by his book *Engineer in Charge*, which was published in 1987. This book presents a careful analysis of the history of the Langley Memorial Aeronautical Laboratory of the National Advisory Committee for Aeronautics (NACA) from its formation in 1917 to the demise of the NACA in October 1958 when this prestigious organization became the centerpiece of the new National Aeronautics and Space Administration (NASA). Whereas the NACA was concerned primarily with aeronautical research conducted by government employees in its own laboratories, NASA would have a much broader charter that included not only aeronautical and space research but also the development and operation of various types of space vehicles, including manned vehicles. Within this new organization, the Langley Aeronautical Laboratory became the Langley Research Center of NASA.

As a part of NASA, Langley underwent many profound changes in program content, organization and management, and areas of personnel expertise. Although aeronautical research continued in the NASA era, research in support of such projects as Echo, Scout, Mercury, Apollo, and the Space Shuttle occupied a larger percentage of the Langley research effort as the years passed. In addition, Langley forged into new fields by assuming management responsibility for such large space projects as Lunar Orbiter and Viking. This responsibility involved major contract activities and support of in-house research. New research facilities, such as large vacuum tanks and high-speed and high-temperature air jets capable of simulating atmospheric entry from space, were developed and constructed.

Although many new personnel were eventually hired, large numbers of the existing Langley complement easily made the transition to space-related research and thus showed that a proficient research professional could shift without too much difficulty into new fields of technical endeavor. For example, in orbital mechanics and space rendezvous, individuals who had previously worked in such diverse disciplines as theoretical aerodynamics, high-speed propellers, and aeroelasticity quickly became expert and assumed roles of national leadership. A well-known case is found in the activities of Dr. John C. Houbolt, an expert in aeroelasticity and dynamic loads, who became a leading proponent—according to Hansen, perhaps the key proponent—of Lunar Orbit Rendezvous as the preferred means of

Spaceflight Revolution

accomplishing the Apollo lunar landing mission. This technique, of course, turned out to be incredibly successful.

A very unsettling aspect of the transition of Langley in the 1958–1975 period was the replacement of the director, longtime Langley engineer Floyd L. Thompson, with Edgar M. Cortright. Cortright came from NASA headquarters and had had prior research experience at the NACA Lewis Flight Propulsion Laboratory (later designated as the NASA Lewis Research Center). In the Cortright regime, along with many significant changes in center organization and management, there came a closer, and many thought an undesirable, control of Langley programs by a centralized NASA management.

James Hansen's new book, *Spaceflight Revolution*, covers the turbulent seventeen-year period from 1958–1975 in great and interesting detail. With his usual thoroughness, Hansen has based this book on careful analysis of hundreds of written records, both published and unpublished, as well as on numerous personal interviews with many of the key individuals involved in the great transition at Langley. One Langley activity that was intentionally omitted from this study is aeronautical research which, as the author mentions, will hopefully be covered in a separate book. *Spaceflight Revolution* is a very complete and well-researched exposition and interpretation of a period of great change at the Langley Research Center. The main events and trends are clearly and succinctly presented. Although many who worked for Langley during the period covered may not agree entirely with some of Hansen's interpretations and conclusions, sufficient information is given in the text, references, and notes to permit the reader to evaluate the work. In any event, anyone who ever worked for Langley or NACA/NASA or who has any interest in the history of technology will find the book fascinating and thought provoking. In addition, anyone interested in the present and the future of NASA and the American space program will want to pay close attention to the insights found in his epilogue. Readers will see that Jim Hansen has again demonstrated his great abilities as a historian, and he deserves a well-earned "Thank you" for creating what will no doubt prove to be an enduring classic.

November 1994

Laurence K. Loftin, Jr.
Director for Aeronautics (Retired)
NASA Langley Research Center

Acknowledgments

In writing this book, I am indebted not only to the many talented and caring people who have helped my project in one way or another in the past seven years but also to a seminal event of my adolescence that has fed my adult interest and colored my historical perspective on what I now see to have been “the spaceflight revolution” of the late 1950s and 1960s.

People all over the world have their personal stories to tell about what they were doing and thinking when they first spotted a mysterious object in the night sky. For many, these stories involve Sputnik because it was the first man-made object to be observed. But for those, like myself, who were too young to be stargazing in 1957, the stories often involve the Echo balloon, NASA’s first communications satellite. Stories about both objects may indeed relate to Sputnik because it was our hysterical reaction to the Soviet satellite that tempered our feelings about objects in space for some time to come.

For me, the memory of my first satellite sighting is still vivid. One sultry evening in mid-August 1960 while I was serving as the batboy for my brother’s Little League team in Fort Wayne, Indiana, something unusual and a little unnerving took place. About halfway through the game, I noticed that fans in the bleachers were no longer watching the game, but instead were standing, looking at the sky, and pointing at something. When our team was in the field and my batboy duties were temporarily over, I found my mother in the crowd and asked her what the fuss was all about. She said she had heard someone in the crowd call it “Echo.” She reassured me that it was nothing to be afraid of, as it “belonged to us.”

But who exactly was “us,” I wondered? To an eight-year-old in 1960, “us” meant human beings or “earthlings”; “them” meant “aliens.” I was glad to hear from my mother that the bright little light that I now, too, spotted moving so slowly yet perceptibly in the heavens did not mean “they” were coming to get me, but I was still concerned. Even at eight, I was informed enough about what was going on in the world to know that “us” and “them” also meant something else almost as sinister as earthlings versus aliens. “Us” meant “Americans” and “them” meant “Russians,” and somehow I knew that it was better for us to have put something up into the sky for the world to look at than it was for them to have done it. Whether I knew that they in fact had *already* done it some three years earlier, I really cannot say. I do remember being so entranced by the man-made star that I had to be told more than once by the coach of our Little League team to “get my head in the game” and go out and pick up the baseball bats.

Spaceflight Revolution

The next night, as soon as it started getting dark, my entire family headed to the backyard to look for Echo, only to find that parents all over our neighborhood were leading their children to hunt for the artificial star. This time my feelings about the bright dot of light moving so clearly across the sky were more positive. We were moving out into space. Like the morning paper had said, Echo was “the visible symbol of American creativity for all the world to see.” In the next several weeks, a number of library books about space would come home from school with me. For me, too, a spaceflight revolution had begun.

As I grew up, so did the American space program. As a second-grader, near the end of the school year that followed the summer of *Echo 1*, I sat on the wooden floor of a gymnasium with all the other kids in my school and watched shadowy black-and-white television pictures of the suborbital flight of Mercury astronaut Alan Shepard. Gus Grissom’s suborbital flight came next; I watched it at home while on vacation that July. Then came John Glenn’s historic orbital flight in February 1962 and a return to TV-watching from telescopic distance on the school gym floor.

After that, my memory of NASA’s space missions is cloudy and does not sharpen again until December 1968, when with the crew of Apollo 8, my family and I spent Christmas Eve circling the lunar sphere, seeing awe-inspiring pictures of the moon’s surface, and listening to the astronauts conclude their TV broadcast with “Merry Christmas and God bless all of you—all of you on the good earth.” I also clearly remember July 1969, when the Apollo 11 lunar module *Eagle* landed on the Sea of Tranquility and Neil Armstrong took that first “small step but one giant leap” onto another heavenly body.

These wondrous events of the space age made a big impression on me, as they did in one way or another on nearly every human being alive at the time. But no space event ever surpassed that first sighting of the Echo balloon, glittering like a diamond over the baseball field.

For a while, mostly on warm summer evenings, I continued to look for Echo and for other objects moving mysteriously through the sky. But gradually, I lost almost all interest in space. A child of the Age of Aquarius and the Vietnam War, I wondered, like so many others did at that time why, if we could put a man on the moon, we couldn’t do so many other things. Only much later would I begin to look up again, seeking Echo, perhaps trying to find lost innocence and youth. Little did I know in 1960 that 30 years later I would reexperience the orbits of Echo and write a detailed history of the satelloon’s genesis, as I have in chapter 6 of this book.

Whatever the object of fixation, be it Sputnik or Echo, stories like mine represent an illuminating cultural expression of the young space age. It was with our stirring personal experiences of these moving little lights in the night sky that the spaceflight revolution began. As one young Canadian girl wrote to NASA in 1968 in a poem entitled “To a Falling Star,” on the eve

Acknowledgments

of *Echo 1's* falling back to its destruction into the atmosphere, "Thanks for making me look up."

* * *

Many times, in thanking all the people who have helped in the research and writing of a book, an author waits until the end of the acknowledgments to thank his own family for their love and support. But in this case, I want to thank my family first. My wife, Peggy, and my two children, Nathaniel and Jennifer, have been last too many times in the seven years it took me to research and write this book to be last once again. I was away from them and at NASA Langley in Virginia for most of every summer from 1987 to 1993 writing this book. This means we all sacrificed and missed each other a lot. Summertime experiences my wife enjoyed with the children at our home in Alabama, she enjoyed alone. I only heard about them in our many long-distance telephone calls. When my children are grown-up and gone from home, I am sure I will regret what I missed with them even more intensely.

I would also like to thank Charles and Robert Stanton. I spent my summers from 1987 to 1993 in their respective homes in Hampton, Virginia, and I enjoyed those times (especially the golf games) tremendously. I am sure that Charlie and Bob heard much more about NASA history than they ever cared to, but they never let on. My friendships with Sharon Buchanan and Rick Thompson while at Bob Stanton's also kept me from being too lonely, as they were a regular part of my Hampton "family." Dr. Fereidoun "Feri" Farassat, a remarkable person and accomplished acoustical scientist at NASA Langley, was also a valued companion. I have learned a great deal from him about science and technology, but what I most cherish is his friendship.

Steve Corneliussen, a talented writer from Poquoson, Virginia, who edited my book *Engineer in Charge* and who then became one of my closest friends, has contributed immensely to my perspective on aerospace history and life in general. Over the years Steve has given me constant, generous encouragement and good advice. I regret that he was so busy with his work at the Continuous Electron Beam Accelerator Facility (CEBAF) in Newport News, Virginia, that he could not serve once again as my book editor.

But how lucky I was to have Kathy Rawson, of Williamsburg, Virginia, edit this manuscript. Kathy has done many wonderful things for this book, turning an overly long and in some essential ways ailing manuscript into a much healthier one. Her consummate professionalism and her friendly words of encouragement inspired me to keep working for *our* book's improvement. In particular, Kathy prodded me in her gentle way to rewrite what was originally a weak epilogue.

As Kathy has told me, many other people associated with the Research Publishing and Printing Branch at NASA Langley came together as a team

Spaceflight Revolution

to see this book to its completion. In particular, I wish to thank Lynn Heimerl, who supervised the entire project, and Mary McCaskill, the branch head, whose strong support for NASA Langley's major investment in the production of this book is sincerely appreciated. Others involved at RPPB that I would like to thank individually include Nancy Sheheen, who oversaw the editing and typesetting process; Linda Carlton, who formatted and typed the majority of the book; Peggy Overbey, who took over the typing for the homestretch; and Sybil Watson and Mary Edwards, who diligently proofread every page.

I also want to thank the staff of the Floyd L. Thompson Technical Library at NASA Langley for their strong support of my project, notably H. Garland Gouger, Jr., Jane Hess (retired), Sue Miller, Sue Seward (retired), Susan A. Motley, and George Roncaglia. Also, the Photographics Section at Langley, under Alton T. Moore, performed yeoman's service for this book by providing excellent prints of its many photographs. I am particularly indebted to Frederick D. Jones not only for doing much of the photo lab work but also for giving me access to a number of pictures from the early days of Project Mercury, many of which he took on his own time with his own camera.

Without the generous support and personal interest of Richard T. Layman of the Facilities Program Development Office, who has been in charge of the history program at NASA Langley since the late 1970s, this sequel to *Engineer in Charge* surely would not have been written. Dick has been constantly available to help me access historical materials and to solve problems associated with my work in the Langley Historical Archives. Dick himself started work at Langley in the early 1960s, and his insights into the center's history proved very helpful.

A. Gary Price and J. Campbell Martin of Langley's Office of External Affairs have also provided tremendous support over many years for my work as the Langley historian, as have Richard H. Petersen and Paul F. Holloway, the Langley center directors during the years I prepared this book. I came to know "Pete" Petersen particularly well and wish to express special thanks to him for his genuine interest in what history books such as mine can offer to NASA management and the public at large.

And then there are the "NACA Nuts," the dozens of men and women whom I first got to know while researching *Engineer in Charge* and came to know even better while investigating their metamorphosis into "NASA Wizards." I wish I could mention all of them by name but must focus on the few whom I have come to know the best: John V. Becker, William Boyer, Clinton E. Brown, Norman Crabill, Charles J. Donlan, John E. Duberg, Macon C. "Mike" Ellis, Robert R. Gilruth, Richard Heldenfels, Jane Hess, Robert Hess, John C. Houbolt, Vera Huckel, Kitty O'Brien-Joyner, Abraham Leiss, Axel T. Mattson, William A. Michael, Mark R. Nichols, W. Hewitt Phillips, Edward C. Polhamus, John P. "Jack" Reeder, Joseph A. Shortal (deceased), William Sleeman, Israel Taback, Helen Willey,

Acknowledgments

Herbert A. "Hack" Wilson (deceased), Richard T. Whitcomb, and Charles H. Zimmerman. To those with whom I talked about Langley's history but have failed to name, please accept my apologies and sincere thanks. Getting to know all of you was the best thing about writing this book.

I need to single out Edgar M. Cortright, another Langley director (1969–1975) and a major player in the history examined at the end of this book, and thank him for the long and comprehensive interviews. Dr. Cortright withheld very little from my tape recorder, and for that I sincerely thank him. I hope he feels that I have treated his time and his achievements at Langley fairly.

Laurence K. Loftin, Jr., the author of this book's foreword, also deserves a special acknowledgment. Over the course of my 14 years as Langley's official (and unofficial) historian, Larry has spent hundreds of hours with me, talking about the history of airplanes, NACA research, and the transition from the NACA to NASA. Much of my perspective about all these things has been shaped in my conversations with Larry. I owe him a huge debt of gratitude, not only because he has saved me from some major technical and historical blunders but also because he and his wife, Agnes, came to treat me over the years almost like a son. Much of my appreciation for what it means to be an engineer comes from the time I spent with Larry.

I cannot fail to mention the help and encouragement given to me freely by my colleagues in the Department of History at Auburn University, a department for which I have been serving as chairman since my election in 1993. A faculty workshop in 1991 took a very critical look at an early draft of my first chapter, thus resulting in a major revision. My colleague, William F. Trimble, who is one of this nation's preeminent historians of naval aviation (and who stays abreast of the history of space exploration), offered a valuable critique of chapter 8 on the genesis of the lunar-orbit rendezvous concept. Major Roy F. Houchin (USAF), one of my doctoral students at Auburn, read a few of the chapters and offered some critical insights. Others in my department whom I have bothered regularly with reports on my work include Guy Beckwith, Lindy Biggs, Anthony Carey, J. Wayne Flynt, Larry Gerber, W. David Lewis, and Steve McFarland. I thank them for being splendid colleagues and good listeners.

Two people at Auburn University that I wish to thank for finding the means and the tolerance to support me in the carrying out of my research projects are Gordon Bond, Dean of the College of Liberal Arts, and Paul F. Parks, University Provost. Before becoming my Dean, Gordon Bond was my department head in history, a job whose difficulties I appreciate now more than ever, since taking on departmental administration myself. Also, without the assistance of an unbelievably hardworking and talented administrative assistant, Jane Dunkelberger, I am afraid the job of the department chairman might have eaten me alive. Jane did an especially good job keeping people away from me in the hectic weeks when I just had to work on this book to meet its deadlines.

Spaceflight Revolution

Other scholars outside of Auburn University also offered critical evaluations of all or part of my manuscript. In particular, I wish to thank Virginia P. Dawson of Case Western Reserve University and Michael Gorn, former chief historian of the Air Force Systems Command and current historian of the U.S. Environmental Protection Agency, for providing very careful and constructive reviews of the entire manuscript. Also, Richard K. Smith, one of the venerable sages in the study of American aviation history, gave the first three chapters a stern critical reading.

Finally, I have been fortunate beyond any reasonable expectations to have had the enthusiastic support of Roger Launius, chief historian for NASA. Roger allowed this book project a high degree of independence. Apparently, he trusted that I could produce, and he had faith that the people at NASA Langley had the ability and judgment to take my book from start to finish without too much management from Washington. I hope the result is a book that he will be proud to say was published in the prestigious NASA History Series.

Finally, I thank you, the reader, for picking up such a big book and giving it more than a passing glance. For you, I have given it my best.

December 1994

James R. Hansen
Auburn, Alabama

In science as in life, it is well known that a chain of events can have a point of crisis that could magnify small changes.

—James Gleick,
Chaos: The Birth of a New Science

*Times go by turns, and chances change by course,
From foul to fair, from better hap to worse.*

—Robert Southwell
“Times Go By Turns”

Prologue

Historians should start from the premise that what happened did not have to happen. They can then do a better job of explaining why it did.

Too often we think about history as something that had to happen just the way that it did. We think about the past as inevitable and predetermined. For example, we think about the American Civil War as an irreconcilable conflict that had to occur given the depth of the regional differences between the North and the South or as a war that the North, given its greater population and industrial might, was bound to win—when, perhaps, neither necessarily had to be the case. The war might have been avoided, or the Southern states might have won their independence, if certain things about the flow of history had been different, perhaps only slightly different.

In 1991 a controversy developed concerning the death of the twelfth president of the United States, Zachary Taylor, who died in 1850 from a mysterious intestinal ailment, conceivably a type of cholera. Given the symptoms of his illness, some believed that Taylor might in fact have died from arsenic poisoning; maybe a Southerner, angry at Taylor for his opposition to the expansion of slavery, found a way to murder him. Based on this theory, in 1991 a coroner and a forensic anthropologist obtained legal approval to exhume Taylor's body from his tomb in Louisville, Kentucky, and conducted an autopsy to try to find traces of arsenic in bits of hair, fingernail, bone, and tissue. As it turned out, they found nothing to substantiate the theory that Taylor was murdered.

While this investigation was going on, columnist George Will wrote a thoughtful essay about the whole affair, in which he suggested that the country might have followed a different path if Zachary Taylor had lived: the Civil War might have been avoided.¹ Even more likely, had he lived, Taylor might have provoked the secessionist movement and brought on the bloodshed 10 years sooner. The South would have faced a North deprived of a decade's worth of growth in industrialism and immigration and would not have confronted a new political party, which found a nation-saving leader in a former Illinois congressman named Lincoln. This Civil War of the 1850s the South might have won.

A more fanciful variation on this what-if theme, again involving the Civil War, can be found in Ward Moore's classic novella of 1955, *Bring the Jubilee*.² One of the great stories of time travel, this fascinating little book is based on the idea that the South won the Civil War because of a single turn of events at the Battle of Gettysburg. Moore's story is rooted in

Spaceflight Revolution

a historical event in which a Confederate patrol fails to arrive at a certain place at a given time, a failure that enabled the Northern forces to occupy a strategic place on the battlefield atop Little Roundtop. In Moore's book, however, the Confederate patrol does secure this strategic position, and the South goes on to win the war. Moore draws a stunning counterfactual portrait of post-Civil War America. The reader encounters a prosperous and progressive South, which has all the great universities, and a backward and poverty-stricken North.

I have taken the time to mention Ward Moore's fantasy and the speculation surrounding Zachary Taylor's death simply to introduce the underlying theme of the epic story of space exploration that follows: the past was no more inevitable than is our future. Contrary to what we might have been taught in school, or to what we might in fact still be teaching, history is not a straight highway. To study history is not simply to take a pencil and play dot-to-dot. Rather, it is to thread a maze, to follow a course of what are potentially limitless directions, including "all sorts of twists and turns and fresh choices of route confronting each new generation." As George Will pointed out in his column on Zachary Taylor, history—whether it is the history of the American Civil War or the history of our own individual lives—is "a rich weave of many threads." Any one of these threads, if pulled out, could cause a radical unraveling, "setting the past in motion as a foaming sea of exhilarating contingencies." In other words, history could have been different: "Choices and chance cannot be scrubbed from the human story. The river of history could have cut a different canyon."³ That is the theme I wish to explore in relation to the history of one of the premier institutions in the American space program, NASA Langley Research Center in Hampton, Virginia.

In the keynote address of a conference on the history of space exploration held at Yale University in 1981, *New York Times* reporter and prominent American space journalist John Noble Wilford asked a provocative what-if question: what if the United States had launched the first satellite in 1957 instead of the Soviets? The United States could have done it. We had German scientists and engineers who had more technical expertise than those "recruited" by the Soviets. As Wilford explains, "Wernher von Braun had the rocket [a modified Redstone designated the Jupiter C] and could have done it about a year before Sputnik, but was under orders from the Eisenhower administration not to—the first American satellite was supposed to be a civilian operation, and von Braun was working for the army at the time."⁴ To guarantee that the president's orders were followed, army inspectors kept a careful watch on the prelaunch activities of von Braun and his men at Cape Canaveral; they suspected that the Alabama-based rocket team might just "accidentally" launch a satellite using what was supposed to be a dummy upper stage of the Jupiter C to boost a nose cone into orbit.⁵

In terms of technical capability alone, the United States could have beaten the Russians into space with a satellite. Explaining why our country

did not and why the Eisenhower administration did not have the ambition to do so is difficult without reconstructing some complex histories. As Walter A. McDougall argues in his Pulitzer Prize-winning book of 1985, *The Heavens and the Earth: A Political History of the Space Age*, the explanation hinges on Eisenhower's philosophy of government, especially his fear of the growing influence of what he would come to call "the military-industrial complex." More specifically, it involves his administration's recognition of the need for satellite reconnaissance of the closed and secretive Communist world, but at the same time, the administration's concern that a hot (and expensive) new battle in the cold war would erupt if an American satellite with military associations flew over the airspace of the Soviet Union. To avoid such an eruption, Eisenhower's political strategists suggested that it would be best to let the Soviets set the legal precedent by orbiting the first satellite; then, when an American satellite followed, the Soviets would not have solid grounds for protesting any American overflight.⁶

With these issues and others in mind, President Eisenhower made his fateful decision to support the more peaceful-appearing but technically inferior Vanguard satellite project rather than the project involving the Army Ballistic Missile Agency's (ABMA) Jupiter rocket. Jupiter, of course, would ultimately boost the first U.S. satellite, Explorer, into space on 31 January 1958, nearly two months after the Vanguard-carrying Viking rocket exploded in flames on the launchpad at Cape Canaveral (the press dubbed it "Flopnik," "Kaputnik," and "Stayputnik") and nearly three months after the Russians successfully orbited their canine-carrying *Sputnik 2*.⁷

If Eisenhower could have known how traumatic and revolutionary the launching of the first satellite would prove to be and what a challenge it would pose to his presidency and his political party, he might have decided differently. The von Braun team might have been turned loose sooner, and the beep-beep-beeping that radio operators heard around the world in early October 1957 might have come from a small American satellite rather than a Russian one.

What if the Americans had launched a satellite first? According to Wilford, "An American first would not have startled the world as much as Sputnik did, for American technological leadership was taken for granted. The impact of Sputnik, when it followed, would have been much less, another case of the Russians catching up, as with the atomic and hydrogen bombs."⁸ And if that had been the case, if Americans had not found Sputnik so challenging, what kind of space program would U.S. leaders have formulated? Surely, that program would have differed from the ideologically motivated and in key respects shortsighted one that was mobilized in such a hurry to win the space race. If Sputnik had not provoked a major international crisis, much about the history of the world in the last four decades of the twentieth century would have been significantly different.

Consider America without a Sputnik crisis. Without the snowballing political repercussions that were so damaging to the Republicans,

Spaceflight Revolution

Richard M. Nixon, Eisenhower's vice-president, possibly would have defeated Democratic Senator John F. Kennedy of Massachusetts in the whisker-close 1960 presidential election. A reversal in that election alone, which turned on a few thousand questionable votes in Illinois, would have produced such an unraveling of contemporary American history that only a Ward Moore could do it justice.⁹

The character of the country's inaugural ventures into space would have been vastly different. Without the media riot, without the panic incited by cold war misapprehensions about the Soviet satellite, without the feeling that the Russians had gotten a jump on us, and without the resulting clamor for our government to do something dramatic *right now* to close the gap, the National Advisory Committee for Aeronautics (NACA), which dated to World War I and was the forerunner of the National Aeronautics and Space Administration (NASA), would have surely lived on.¹⁰ Most likely this agency would have proceeded calmly with plans to expand its space-related research, and NASA would not have been established, at least not when it was. The United States would still have entered into space, but the country would not have rushed into it.

Instead of plunging into the ocean in a ballistic capsule, the first American astronauts might have flown back from space on the wings of a hypersonic glider similar to those NACA researchers had been working on since the mid-1950s. If the United States had not lacked a booster rocket powerful enough to lift so heavy a weight out of the atmosphere, the first spaceflight might have happened like that anyway, even with the Sputnik crisis. The original seven astronauts (the ones with "the right stuff") or more likely, specially trained NACA or military test pilots would have traveled to space and back in a landable space plane akin to a small space shuttle. Given the time needed to develop the requisite booster and considering the extensive development and careful flight testing that such a radically new, winged reentry vehicle inevitably would have undergone, the hypersonic glider probably would not have been launched into space until the late 1960s, but it surely would have proved much more capable and versatile than the Mercury capsules.¹¹

Moreover, instead of sending men to the moon by the end of the decade as President Kennedy had wanted, an NACA-led program under President Nixon likely would have focused on the construction of a small, staffed space station that could have been serviced by the shuttle-like vehicle. Such was the target project for space exploration at the NACA research laboratories before Sputnik, and it remained so until President Kennedy's lunar commitment in May 1961.¹²

Whatever we think about the might-have-beens and paths-not-taken, the undeniable fact is that Sputnik changed the course of history. Sputnik was one of those revolutionary, megahistorical events that interrupted the flow of things, altered the would-have-beens, and made a lot of very unlikely events happen. No one has expressed the irony of the randomness and illogic in the

historical process better than the longshoreman-philosopher and quasi-cult figure of the 1950s and 1960s, Eric Hoffer. “What were the terrible 1960s and where did they come from?” asked Hoffer after the end of the decade. “To begin with, the 1960s did not start in 1960. They started in 1957. . . . The Russians placed a medicine-ball-sized satellite in orbit. . . . We reacted hysterically.”¹³ If we had not, or if we had put that “ball” in orbit first, everything would have been different. For the past was no more inevitable than is our future.

After Sputnik, the American space program would contend with other critical turning points and other what-ifs: What if President Kennedy had not committed the country to the manned lunar landing—or at least not to accomplishing it so quickly? What if NASA had not chosen lunar-orbit rendezvous as the mission mode for Apollo and had instead gone with direct ascent or earth-orbit rendezvous, as most engineers at NASA Marshall Space Center had wanted? What if the national supersonic transport (SST) program had not been cancelled by Congress in 1971? (The U.S. Senate killed the program by only one vote.) Would the United States be flying a competitor to the Concorde? Would the resulting airplane have been a disastrous failure, thus putting Boeing and most of its customers out of business? What if the Nixon administration in 1972 had not decided to go ahead with a scaled-back version of the space shuttle but instead had wanted to develop a space station? What if President Reagan had not endorsed the space station in 1984? What if the temperature at Cape Canaveral on the morning of 28 January 1986 had been only a few degrees warmer? These are just some of the what-if questions we might ask about NASA and the American space program.¹⁴

The study of history, at least the history of NASA, reveals something about the past that should not be surprising, but is: historical development is neither linear nor logical. In practice, talking about the next logical step, something that NASA planners have been talking about nonstop ever since NASA came to life, does not ensure that step will be the next one taken. After launching a man into space via Project Mercury, NASA said that the next logical step was to establish a permanent manned presence in low earth orbit, but instead the country landed men on the moon. After going to the moon via Project Apollo, the next logical step was to build an earth-orbiting space station along with a space shuttle to service it, but instead the Nixon administration decided that the country could not afford both and could manage temporarily with just the shuttle, even though the space station had always been the shuttle’s main reason for existing. After the shuttle, surely the next logical step was to build a space station, but once again the country has found reasons to postpone building one.

Clearly, logic does not determine our history. Historical logic, if we even want to use that phrase, is not the logic of scientists and mathematicians; it is the logic of *Through the Looking-Glass*. In that all-too-real fantasy land, Tweedledee explains logic to Alice: “Contrariwise, if it was so, it

Spaceflight Revolution

might be; and if it were so, it would be; but as it isn't, it ain't. That's logic."¹⁵ Tweedledee's logic is the only kind the American space program has ever known, or probably ever will.

In this book, I explore the impact of that logic on the research and development activities conducted at Langley Research Center in the 12 years after Sputnik. As the book's title suggests, this impact was revolutionary. I gave much thought to the word *revolutionary* before using it. In the history of science, since the publication of Thomas S. Kuhn's seminal study *The Structure of Scientific Revolutions* in 1962, no historian, in fact no scholar, has been safe in the use of the term *revolution* without reference to the essential Kuhnian concepts and terminology: "paradigm," "anomaly," "normal science," "Gestalt switch," "paradigm shift," and the "incommensurability of paradigms," to name just a few.¹⁶ All these terms, along with the word *revolution* itself, which Kuhn defines as "those noncumulative developmental episodes in which an older paradigm is replaced in whole or in part by an incompatible one," have thus been loaded down with meaning, nuance, argument, controversy, and their own long academic histories.¹⁷

But the reader can relax. Nowhere else in the text or notes of this book will I make direct reference to Thomas Kuhn or his sociological anatomy of revolution. I do not omit Kuhn because of any disdain for his insights; I just do not feel that any explicit application of Kuhn's analysis of scientific revolutions will do much to inform my chosen topic relevant to NASA Langley history. Whether Kuhn's notions have worked implicitly to influence my understanding of the spaceflight revolution at the research center, I leave to the reader to judge.¹⁸

Most scholars are familiar with Kuhn and his concept of revolution; far fewer are familiar with the particular concept of the *spaceflight revolution* for which Kuhnian sociologist William Sims Bainbridge is responsible. Despite my using Bainbridge's terminology and even sympathizing with parts of his concept, I wish to distance myself and this book on NASA Langley from it, even farther than I have from Kuhn.

In 1976 Bainbridge, a professor in the sociology department at the University of Washington, published a fascinating if eccentric analysis of the enthusiasms of the space age, *The Spaceflight Revolution: A Sociological Analysis*.^{*} According to its thesis, the space age came to life "despite the world's indifference and without compelling economic, military, or scientific

* Even Bainbridge worried that the word *revolution* might be too strong. In the introduction to his book he defends its use, saying that "the scale and the manner of the achievement" in space "demand powerful language." According to his estimates, "approximately \$100,000,000,000 has been spent on space technology; the exact figure is debatable, but the order of magnitude is not." Moreover, Bainbridge continued, "I use the word *revolution* as a scientifically descriptive term [as Kuhn did], not a metaphor. The development of spaceflight could be a revolution in two ways: its consequences and its causes." (*The Spaceflight Revolution: A Sociological Analysis* [New York: John Wiley & Sons, 1976], p. 1.)

reasons for its accomplishment.” It was not the “public will,” declared Bainbridge, but “private fanaticism” that drove us to the moon. “When Neil Armstrong called his ‘small step’ down on to the lunar surface a ‘great leap for mankind’, he spoke as the partisan member of a revolutionary social movement, eager to convert the unbelieving to his faith.”¹⁹

Bainbridge’s book essentially advances a conspiracy theory. The majority of people did not want spaceflight; only a few did. And those few romantic idealists, that extremely small but dedicated and well-organized network of men (very few women were at first involved, according to Bainbridge), coaxed, tricked, lobbied, and coerced the greatest technological nations into building mammoth programs to launch them into space. Bainbridge then analyzes the historical and social character of the conspirators: the pioneers and visionaries of spaceflight (the Russian Konstantin Tsiolkovskii, the German Hermann Oberth, and the American Robert Goddard, among others); the enthusiastic members of the early space and rocket clubs (such as the German Society for Space Travel, the British Interplanetary Society, and the American Interplanetary Society); Wernher von Braun’s rocket team in league with the Nazis at Peenemünde; the agenda of the Committee for the Future, that “mystical, almost religious organization,” which came to life in the United States in 1970, less than one year after the first manned lunar landing; and finally, the science-fiction subculture, which he calls the “breeding ground of deviant movements,” and the Star Trek and Search for Extraterrestrial Intelligence (SETI) groupies of the present day.²⁰

The book is a brilliant and troubling tour de force from a sociologist of some estimable abilities. I assign it perennially to my graduate students in aerospace history and not just to get a rise from them, which it always does—particularly from the students specializing in military air power who usually think that Bainbridge is simply silly or crazy. Bainbridge’s version of the spaceflight revolution is worth investigating, if only because it explores the question of why something that did not have to happen, *happened*. In the introduction to his book, Bainbridge writes, as I have written in this prologue, that the spaceflight revolution “was a revolution that need not have happened.”²¹

In my version of the spaceflight revolution, however, the revolutionaries are not conspirators from rocket enthusiast organizations and science-fiction clubs, nor are they romantic idealists aspiring to some quasi-religious, superhuman, or millenarian experience in outer space. And they are hardly members of a deviant social movement. Rather, my revolutionaries are government engineers and bureaucrats, who are members of an established research organization dating back to 1915, the venerable NACA. These revolutionaries, because of the hysteria over the launch of *Sputnik 1* in October 1957, metamorphosed along with their organization into creatures of the space age.

My spaceflight revolution is an unlikely story—perhaps as unlikely as Bainbridge’s. But this one happened.

1

The Metamorphosis

*It was the worm, if you will, going into the cocoon
and coming out a butterfly.*

—Walter Bonney, NACA/NASA
public relations officer

The first week of October 1958 was a busy time for the newspapers of Tidewater Virginia. Top stories included the explosive failure of an Atlas missile at Cape Canaveral, an atomic blast in Nevada that sent news and test personnel scurrying for cover from radiation fallout, the question of Red China's membership in the United Nations, and a United Auto Workers strike against the Ford Motor Company. Receiving the biggest headlines in the local papers, however, were stories concerning the path of Hurricane Helene up the Atlantic coast and the furor over the court-ordered integration of public schools, which was taking place as far away as Little Rock, Arkansas, and as nearby as Richmond and Norfolk. Not even making the front page of the Newport News *Daily Press* on the cool, overcast morning of Wednesday, 1 October 1958, was the news that the National Advisory Committee for Aeronautics (NACA) had died the night before at midnight, only to be reborn at 12:01 a.m. as the National Aeronautics and Space Administration. Just a few hours earlier, on Tuesday, 7000 people had left work as NACA employees, but when they reported to their same jobs in the same buildings the next morning, they became members of NASA.*

A few NACA veterans might have felt a twinge of doubt as they drove past the new NASA sign at the gates of Langley Research Center, but most NACA personnel were not at all nervous or wary about the changeover. Plans for an easy transition had been in the works for at least eight months,

* Although foreigners tended to pronounce it as a two-syllable word, "Nacka," within the United States the organization was always known by its four individual letters, "the N-A-C-A." Veterans of the NACA assumed that the same would be true for NASA. Into the 1990s, NACA veterans could usually be identified by the way they treated the NASA acronym as individual letters.

Spaceflight Revolution

since President Dwight D. Eisenhower's panel of scientific advisers had recommended that a new civilian space agency be organized around the NACA.¹ Almost everything about working at Langley Field, or at any of the other former NACA facilities around the country, was supposed to remain the same. Employees had been reassured for several weeks by NACA headquarters and by Langley management that they were to come to work as always and do the same things they had been doing. Their jobs already had much to do with the nation's quickly accelerating efforts to catch up with the Soviet Union and launch America into space. As NASA personnel, they were simply to keep up the good work.

After watching from a distance the hysteria provoked by the Soviet satellites and the political jousting and bureaucratic haggling that followed, Langley employees were relieved to see President Eisenhower resist the pressures applied by the military, particularly the air force, to militarize the infant American space program.² Ike, the former five-star army general and leader of the invasion of Nazi-occupied Europe in 1944, had risen above these pressures and put civilians in charge, entrusting the NACA with the space program. A small overhead agency that was both focused and accustomed to squeezing a dollar, the NACA appealed to a genuine balanced-budget man like Eisenhower.

The creation of the NACA had been quite different from that of NASA. Although a group of prominent Smithsonian and Washington aviation enthusiasts had conceived the idea of an organization devoted to the support of aeronautical development as early as 1910, the actual founding of this new federal agency proved difficult, especially since aviation had not yet demonstrated its efficacy in World War I combat. In fact, establishment of the NACA might not have been approved if a friendly group of congressmen, fearing that President Woodrow Wilson's policy of neutrality was preventing the United States from properly preparing for its inevitable role in the war, had not devised a successful last-minute maneuver. In a classic example of American political sleight-of-hand, they attached the NACA enabling act as a rider to a naval appropriations bill that was sure to pass, and the NACA came into being on 3 March 1915.³

For an important new government body to be established in such a manner was really quite extraordinary. But certainly no one in 1915 or for several years thereafter, perhaps not even many early NACA employees, considered the NACA very important. Now, 43 years later, President Eisenhower was making it the heart of the new American space program for which everyone was clamoring. Because of the heated public debate over national space policy, NASA could not have been founded in the relatively invisible way that the NACA had been established. Unlike the old agency, NASA was going to be exposed to direct congressional, media, and, consequently, public scrutiny from the start.

Probably no NACA employees arriving at work on NASA's first day anticipated the impact that this new life in a goldfish bowl eventually would



L-58-68a

Although his administration gave birth to NASA, President Dwight D. Eisenhower did not believe that the United States should rush into a “crash” federal program to beat the Soviets into space. Instead, he hoped for a more judicious and less hysterical approach to space exploration, one that would not require massive infusions of public funds but would still enable the United States to remain a leader, if not the leader, in space. His Democratic successors, John F. Kennedy and Lyndon B. Johnson, would commit the country to an all-out race.

have on their work and workplace. Change is difficult to perceive and evaluate while it is happening, let alone when it occurs in the middle of a week. Charles J. Donlan, veteran Langley researcher and soon-to-be-named associate director of NASA’s Space Task Group, later reminisced about the innocence of his thoughts on the day the NACA became NASA: “It was like passing from December 31 to January 1 without going to a party. You didn’t know the difference except that it was the New Year and you had to start signing your checks for one year later.”⁴ Indeed, a new era had begun, and although this was not apparent on the uneventful morning of 1 October 1958, Langley Research Center was now exposed to the complex forces and extreme circumstances that were rapidly reshaping U.S. aeronautical research and blasting the center pell-mell into space.

The Venerable Order of the NACA

The basic duty of the NACA, as expressed in its charter, was “to supervise and direct the scientific study of the problems of flight, with

Spaceflight Revolution

a view to their practical solution, and to determine the problems which should be experimentally attacked, and to discuss their solution and their application to practical questions.” But the original charter of 1915 did not assure the funds for the large, diversified, and increasingly expensive research establishment that the NACA eventually became. It stated only that “in the event of a laboratory or laboratories, either in whole or in part, being placed under the direction of the committee, the committee may direct and conduct research and experiment in aeronautics.”⁵

That mandate was general enough to allow widely differing interpretations, and not everyone responsible for the NACA in its formative years agreed on what the mandate meant or, rather, what it should mean. Some felt that the NACA should remain small and continue to serve, as it had throughout World War I, merely as an advisory body devoted to scientific research. Others argued that the NACA should grow larger and combine basic research with engineering and technology development. This second group wanted the NACA to attack the most pressing problems obstructing the immediate progress of American aviation; the group did not want the agency to spend all of its time on ivory-tower theoretical problems that would not result in many quick, practical payoffs. To be so effective, the NACA needed to have its own laboratory facilities and conduct its own programs of research.

The NACA moved slowly but surely along the second course, and building a laboratory became its first order of business. Construction of the Langley Memorial Aeronautical Laboratory, the NACA’s original field station, began approximately 100 miles southeast of Washington, on an isolated peninsula of Tidewater Virginia in 1917. Named after Dr. Samuel P. Langley (1835–1906), an eminent American scientist whose pioneering experiments with powered flight at the turn of the century had been a mixture of success and failure, Langley served as the NACA’s only research center for the next 20 years.⁶ Some flight research was conducted there in late 1919 and early 1920, but the laboratory did not really begin routine operations until after the completion of its first wind tunnel in the summer of 1920.

By the mid-1920s, engineers, not scientists, were put in charge at Langley. The head of the laboratory would in fact be called the “engineer in charge.” The choice of engineers over scientists reinforced the NACA’s decision to become an agency concerned with the practical, not the purely theoretical. Engineers would always support the NACA’s charter. On Langley engineer Floyd L. Thompson’s desk sat a framed quotation of the essence of the charter: “The scientific study of the problems of flight with a view to their practical solution.” The quote stayed on Thompson’s desk until he retired from NASA as the director of Langley Research Center in 1968.

In the years following its founding, the NACA expanded far beyond the advisory role defined in its charter. The NACA served as a national clearinghouse for scientific and technical information by establishing uniform

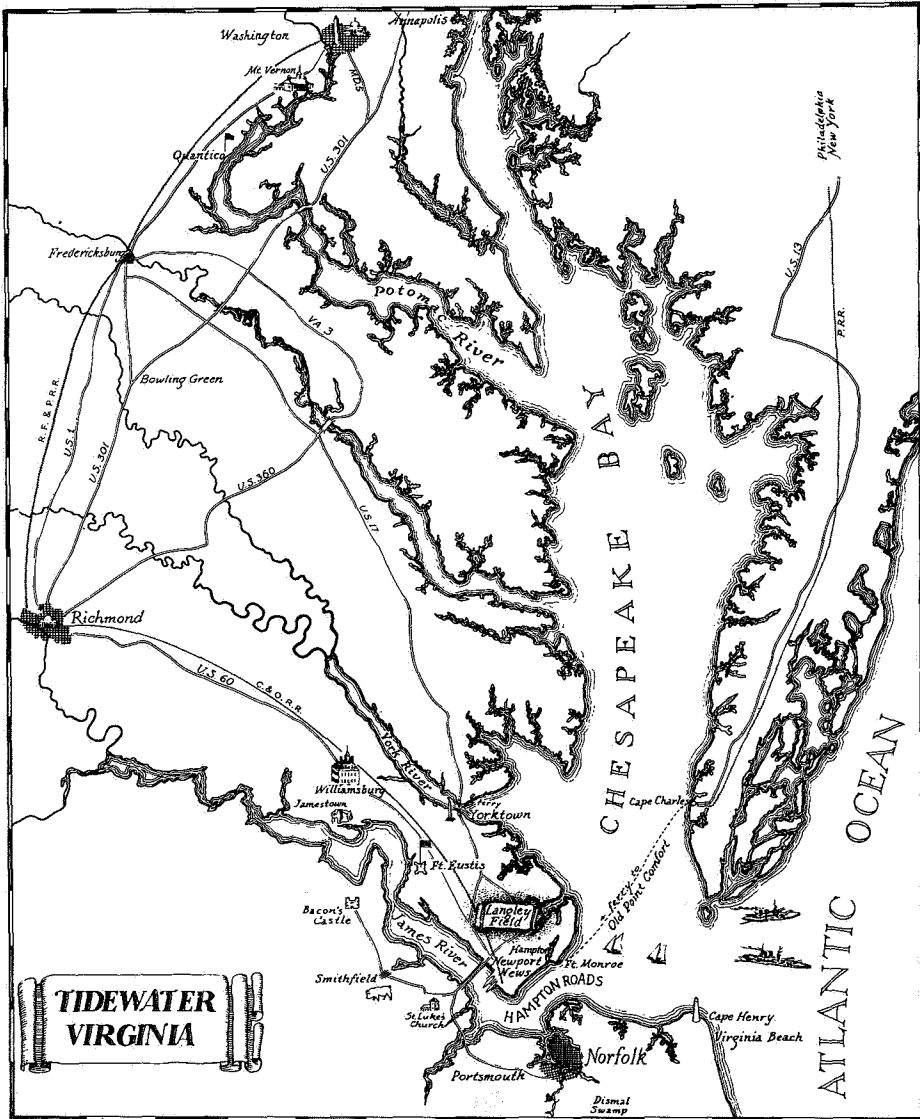

L-36,942

A Langley map of the Tidewater Virginia area from the late 1930s.

Spaceflight Revolution



L-62-6373

Floyd L. "Tommy" Thompson was Langley Research Center's associate director in 1958, its "number two" man under longtime and soon-to-retire Director Henry J. E. Reid. The number two man in those days also acted as the chief of research.



L-9850

Orville Wright, Charles Lindbergh, and Howard Hughes were among the attendees at Langley's 1934 Aircraft Manufacturers' Conference. Conference guests assembled underneath a Boeing P-26A Peashooter in the Full-Scale Tunnel for this photo.

aeronautical terminology; publishing reports; and collecting, compiling, and disseminating basic information in the various fields pertinent to aeronautics. It also contracted out research projects to universities. From 1926 on, it held annual meetings known as the NACA Aircraft Manufacturers' Conferences, which brought in experts from around the United States to talk about aviation technology and what the NACA should be doing to stimulate further progress.⁷ It built up staffs to conduct research in aerodynamics, hydrodynamics, structures, and propulsion. Solutions to problems in these areas led to the design and operation of safer, faster, higher flying, and generally more versatile and dependable aircraft. With these aircraft, the United States became a world power in commercial and military aviation, and Allied victory in World War II was assured.

To help meet the demand for advanced airplane work during World War II, the NACA created four new national facilities and seeded them with staff from Langley. They were the Aircraft Engine Research Laboratory, built in Cleveland, Ohio, in 1941 (later renamed the Lewis Flight Propulsion Laboratory and later still the Lewis Research Center); the Ames Aeronautical Laboratory, created at Moffett Field, California, also in 1941 (later renamed Ames Research Center); the Pilotless Aircraft Research Station, built on barren Wallops Island on Virginia's Eastern Shore in 1944 (later renamed Wallops Station); and the High-Speed Flight Station, established at Muroc Field (subsequently, Edwards Air Force Base [AFB]), California, in 1946 (later renamed Dryden Flight Research Center). At the last facility in the high California desert, a special unit of engineers from Langley supervised the flight trials of the first supersonic airplanes, the Bell X-1 and the Douglas D-558. Considering the many technological firsts and other achievements arising from this array of unique facilities, it is clear why many experts believe the NACA did at least as much for aeronautical progress as any organization in the world.⁸

Indeed, the NACA's track record was not bad for a committee, or rather, for a pyramid of committees—the NACA consisted of more than one. Foremost was the NACA's *Main Committee*, an unpaid body that met twice a year in Washington to identify and discuss the key research problems that the agency should tackle. Until World War II, it comprised 12 members and from then on 15. Members represented the War and Navy departments (normally two from each), the Smithsonian Institution, the U.S. Weather Bureau, and the National Bureau of Standards, as well as select universities, industries, and airlines. The list of 120 men who served on the NACA Main Committee ("*The NACA*") from 1915 to 1958 is a "Who's Who" of American aeronautics: Dr. Joseph S. Ames, Gen. Henry "Hap" Arnold, Dr. Vannevar Bush, Harry F. Guggenheim, Dr. William F. Durand, Dr. Jerome C. Hunsaker, Charles A. Lindbergh, Adm. William A. Moffett, Capt. Edward V. "Eddie" Rickenbacker, Gen. Carl "Tooe" Spaatz, Gen. Hoyt Vandenberg, and Orville Wright, to name a few. The president of the United States appointed all members, and in turn the Main Committee

Spaceflight Revolution

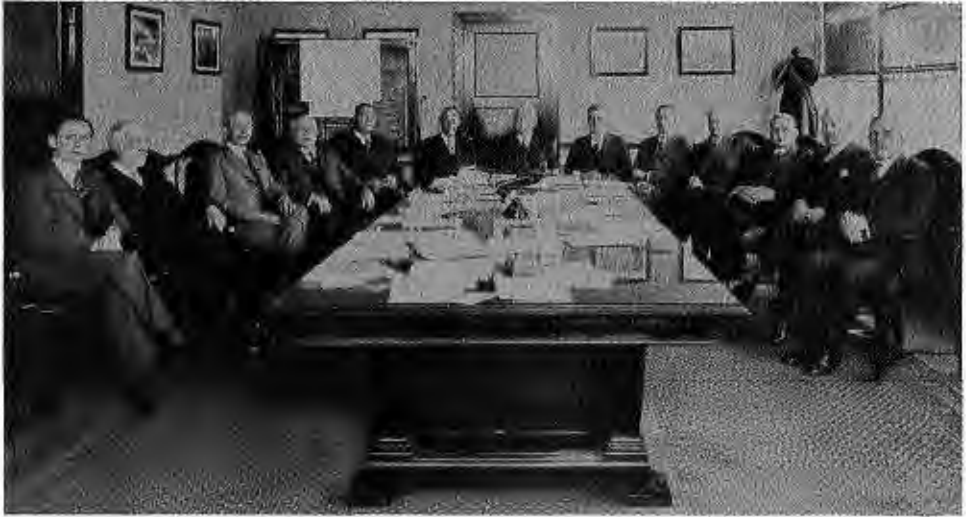

L-90-3727

An 18 April 1929 meeting of the NACA Main Committee. Around this table sat some of the most outstanding authorities on the science, technology, and military uses of flight. Left to right: John F. Victory, NACA secretary; Dr. William F. Durand, professor and head of the Department of Mechanical Engineering, Stanford University; Dr. Orville Wright; Dr. George K. Burgess, director, Bureau of Standards; Brig. Gen. William E. Gilmore, U.S. Army; Maj. Gen. James E. Fechet, Chief of Air Service, USA; NACA Chairman Dr. Joseph S. Ames, professor of physics and president of Johns Hopkins University; NACA Vice-Chairman Dr. David W. Taylor, former Chief Naval Constructor, U.S. Navy; Capt. Emory S. Land, Navy Bureau of Aeronautics; Rear Adm. William A. Moffett, Chief, Bureau of Aeronautics; Dr. Samuel W. Stratton, former director, Bureau of Standards; Dr. George W. Lewis, NACA director of research; Dr. Charles F. Marvin, Chief, Weather Bureau.

reported directly to him via an annual written report. The eighth and last chairman of the Main Committee was Dr. James H. “Jimmy” Doolittle, the former racing pilot, air war hero, retired air force general, and Ph.D. in physics from Massachusetts Institute of Technology (MIT). On 30 September 1958, the day before NASA took over, he sent the NACA’s 44th and last annual report to President Eisenhower.

The NACA was quite independent. Although the president appointed its members, he did so on advice from the standing NACA Main Committee, advice that Eisenhower and his predecessors almost always took. This helped to take politics out of the selection process. Furthermore, the Main Committee chose its own chairman and director of research and, in the words of longtime NACA member (1922–1923, 1938–1958) and former chairman



L-16,243

One of the outstanding men to chair the NACA was Vannevar Bush (center), the computer pioneer and head of the Office of Scientific Research and Development during World War II. Bush chaired the NACA from 1939 to 1941. On either side of Bush stand George W. Lewis, the NACA's longtime director of research (right) and Henry Reid, Langley's engineer-in-charge (left).

(1941–1956) Jerome Hunsaker, “ran its show, within its budget, made its own statements to Congress for what it wanted to do and could do and was doing, and got [its] budgets without any interference from the executive branch of government.”⁹

Organizationally, the old NACA committee system did not stop with the Main Committee.¹⁰ Its members elected a smaller *Executive Committee* of seven who served terms of one year and acted as the NACA's actual governing body. This Executive Committee also appointed several *technical committees* that provided expertise to the parent committees on such major subjects as aerodynamics, power plants for aircraft, and aircraft construction. In turn, these committees (actually subcommittees) created sub(sub)-committees of their own to study and give advice in more specialized areas, such as aircraft fuels, aircraft instruments, and aircraft operating problems. The NACA also had *special committees*, usually ad hoc, that dealt with extraordinary problems such as the need, in 1938, to build new facilities to

Spaceflight Revolution

meet the threat of another world war. Twenty years later, in the middle of another international crisis, the NACA had a special committee working to explore the ramifications of Sputnik and to help formulate a space policy for the NACA.

The committee system did not work perfectly, but in its unique way it did work. Prominent people in the American aviation enterprise became familiar with NACA capabilities and NACA results; concurrently, the NACA benefited from the insight of many talented and experienced men (no women ever served on any of the NACA committees). Further, the connections and the prestige of committee members helped the NACA to win friends and secure appropriations from Congress. Over the years, outsiders such as the Brookings Institution, self-styled experts in government organization, and several officers in the Bureau of the Budget had viewed the committee system of advise and consent as a messy way to structure and manage a federal agency. But NACA insiders did not. Nothing about the committee system meddled seriously in any unwelcome fashion with work in the laboratories. The actual management of the research operation was left to the civil servants who worked full-time for the NACA. Within the laboratory itself, management was left to the engineer-in-charge.*

At the Washington level, the management of research was left to the NACA's director of research. Only two men held this post during the NACA's 43-year history. Dr. George W. Lewis (honorary doctorate from Swarthmore, his alma mater) held the post from the time it was established in 1919 until his retirement in 1947. Dr. Hugh Dryden (one of the youngest Ph.D.'s ever to come out of Johns Hopkins University, in 1919, at age 21) served from 1947 to 1958. These two men, of very different backgrounds, demeanors, and talents, guided the NACA through the rapid technological evolution and sudden revolutions that in less than half a century had taken aeronautics on a turbulent whirlwind from the era of wooden biplanes, ponderous airships, and subsonic flight into the age of jets, supersonics, and rockets at the edge of spaceflight.¹¹

Most critics agreed that the NACA had served the general cause of American aeronautics well for more than 40 years. But now in the wake of Sputnik, they felt the time had come for a major reorganization and the injection of new blood. By early 1958, a growing number of American leaders joined in that opinion and were ready to tell the NACA thanks, slap it on the back, and bring its experiment in government organization to an end. A bold new initiative was required if the United States was to catch up to the Soviet Union. Space enthusiast Senator Lyndon B. Johnson, chairman of the Senate's new Special Committee on Space and Astronautics, felt this

* In 1948 civil service requirements had forced the NACA to change the old title to director. No one liked the change, certainly not Langley's top man, Henry Reid, who had been engineer-in-charge for 22 years, since 1926. The old title had made it clear that an engineer, not a scientist, headed the organization.



L-90-3751

The NACA's directors of Research, George W. Lewis (left) and his successor, Dr. Hugh L. Dryden (right).

way, as did others. They claimed that the old NACA was too timid and too conservative about exploring the potential of space. Such critics, as well as some “young Turks” inside the NACA, felt that if the organization was to be reincarnated as NASA, then it should be revamped with new personnel and additional facilities and charged up by new leaders.¹² Out of this general sentiment for major change came the National Aeronautics and Space Act of 1958. The Space Act gave NASA an advisory board, but insiders knew it could not be the same as it was under the NACA. On NASA's first day, 1 October 1958, the NACA committee system was essentially discarded.

Glennan: Welcome to NASA

At the head of NASA was Dr. T. Keith Glennan. When Eisenhower announced Glennan as his choice for the NASA administrator on 9 August 1958, people at Langley and at other NACA centers asked, who was Glennan? They learned that he was the president of Case Institute of Technology in Cleveland. Then he must be a member of the NACA Main Committee? No, he was a former Hollywood movie mogul and a minor one at that, not in the class of a Samuel Goldwyn or Louis B. Mayer.

These answers, which circulated via the NACA grapevine late in the summer of 1958, appalled some NACA employees, did not make much sense to most, and made none of them very happy. In its 15 August edition, the Langley *Air Scoop*, the in-house newspaper, ran a picture of 53-year-old

Spaceflight Revolution

Glennan along with a complete biographical sketch provided by Case Institute of Technology. Reading this article, Langley employees found that Glennan indeed had been a manager for Paramount and Samuel Goldwyn studios during World War II, but that his overall career was marked by “achievements in business, education, and the administration of scientific research.”¹³ In recent years he had served on the Atomic Energy Commission and on the board of the National Science Foundation, and he was supposed to have excellent connections in Washington. Considering the highly charged and politicized atmosphere now surrounding everything that had to do with rockets and space, something finally made sense about Glennan’s selection. At ceremonies held in the White House on Tuesday, 19 August, Dr. Glennan raised his right hand, put his left on a Bible, and pledged the oath as NASA administrator. On the same Bible, close enough to touch the ends of his fingers, was the left hand of faithful Methodist lay minister Dr. Hugh Dryden, the NACA’s director of research. Although many in Congress wanted Dryden out of the picture because they thought that his quiet, almost mousy personality and conservative approach to launching America into space might tarnish the images of youthfulness, dynamism, and boldness they wanted for NASA, Glennan had insisted on making him his deputy administrator, and Dryden had accepted.¹⁴ Glennan thought that this selection would help provide continuity and make the metamorphosis into NASA, as well as his own administration, easier for NACA people to accept. Other NACA headquarters officers came to NASA with Dryden, including John F. Victory, the Main Committee’s fastidious executive secretary and first employee. (Victory had been working for the NACA since 1915.) Some viewed President Eisenhower’s appointment of Jimmy Doolittle, the last NACA chairman, to his nine-member National Aeronautics and Space Council as another gesture toward the NACA old guard. For Eisenhower, however, the appointment of Doolittle was more than a gesture. Ike knew Doolittle, his former World War II air force commander in North Africa and Europe; trusted his judgment; and wanted his moderate, reasonable, and experienced voice on the newly formed space council.

On the morning of 1 October 1958, not a single member of the Langley senior staff was likely to have remembered ever meeting Glennan. The new NASA administrator had not yet visited Langley or any other NACA facility, at least not as the NASA administrator. However, the former Hollywood executive had appeared at Langley via motion picture. On 22 September, the NACA public affairs officer in Washington, Walter Bonney, sent copies of a short 10-minute film, “Glennan Message to NACA Employees,” for immediate showing at all NACA centers.¹⁵

At Langley, employees gathered in the East Area a few days later to watch the film in the air force base’s air-conditioned theater, next to the old 19-Foot Pressure Tunnel, which dated to 1939. From its beginning, something about the film made many people in the audience uneasy. Perhaps they were disturbed by the Orwellian undertone of the presentation, a confident and



L-58-14a

Glennan introduces himself to the Langley staff via motion picture.

soothing “Big Brother” message coming to the people electronically from the center of government. This message did not come from the NACA’s staid old headquarters at 1512 H Street NW in Washington (referred to as the “Washington office”), but rather from Glennan’s new deluxe office within the recently acquired suite of NASA administrative offices in the Dolly Madison House at nearby 1520 H Street NW. Word had circulated that Glennan had had his office suite decorated just like the one he had enjoyed as president of Case Institute of Technology.

The movie opened with the NASA administrator leaning on the front of his desk. “I very much want to talk with you about our future,” Glennan began. But before he described “the mighty big job” that lay ahead for NASA, he took time to praise the NACA. He explained that during his 11 years at Case Institute of Technology in Cleveland, he had worked with many people at NACA Lewis. He was both “familiar with [the] NACA’s traditions and accomplishments” and “impressed by the high state of morale and by the vigor” with which the NACA conducted its research.¹⁶ Glennan failed to mention, however, what he would soon record in his personal diary, his opinion that the NACA staff was “composed of reasonably able people,” lacking experience in the “management of large affairs.”¹⁷ According to

Spaceflight Revolution



L-59-22

Glennan's first live appearance at Langley in early January 1959. Here he is being welcomed by Henry Reid, the center director.

one member of the Langley senior staff, Glennan “had so little knowledge of the organization” at the outset that he did not think its staff “had any competence.” Upon seeing the huge vacuum spheres belonging to the Gas Dynamics Laboratory at Langley, Glennan allegedly remarked, “NASA doesn’t have any capability to handle that kind of high pressure stuff. You’re going to have to get some help from outside to do that, you know.”¹⁸

Despite his true feelings, Glennan stressed in his message that “NASA must be like [the] NACA in the qualities of strength and character that make an organization great,” but he also emphasized the arrival of “a new day” at Langley. To describe that new day, the NACA’s changeover to NASA, Glennan quoted from what he called the “legalistic language” of the Space Act: “the NACA shall cease to exist” and “all functions, powers, duties, and obligations and all real and personal property, personnel (other than members of the Committee), funds, and records” of the NACA were to be transferred to NASA. But, he explained, he preferred to think of it differently: “I would like to say, and I believe that I am being very realistic and very accurate when I do, that what will happen September 30 is a sign

of metamorphosis. [It is] an indication of the changes that will occur as we develop our capacity to handle the bigger job that is ahead.”¹⁹

The bigger job was outlined in the Space Act, which he encouraged all NACA employees to take the time to read, at least its first few pages. The job included the “expansion of human knowledge about space ... development and operation of vehicles capable of carrying instruments and man through space ... long-range studies of the benefits of using aeronautical and space activities for peaceful and scientific purposes ... preservation of the role of the United States as a leader in aeronautical and space science and technology.” Glennan also outlined the metamorphosis. The NACA’s vital function, research into the problems of atmospheric flight, would now become “only one part of NASA’s activities.” To accomplish the goals set out in the Space Act, NASA would have to add “new and extremely able people” to its staff; administer “substantial programs of research and development and procurement with others on a contract basis”; spend “large amounts of money outside the agency by contracts with scientific and educational institutions and with industry”; use military facilities “such as the launching pads at Cape Canaveral”; and operate satellite-tracking stations around the world. All this and more had to be done and quickly in preparation for a manned flight into space and exploration into the Solar System.²⁰

Finally, Glennan tried to end his message on a high note by quoting from a speech that Lyndon Johnson made in August during the Senate confirmation hearings of the top two NASA officials:

There are no blueprints or roadmaps which clearly mark out the course. The limits of our job are no less than the limits of the universe. And those are limits which can be stated but are virtually impossible to describe. In a sense, the course of the new Agency can be compared to the voyage of Columbus to the New World. The only difference is that Columbus with his charts drawn entirely from imagination had a better idea of his destination than we can possibly have when we step into outer space.²¹

Most NACA employees filing out of the base theater felt positive and excited about what they had heard, but a few cynics might have wondered out loud about that last reference to Columbus: “Wasn’t he headed for China? And didn’t he believe to his dying day that he had landed in Asia?” Hopefully, NASA had a better idea of its destination and would know where it was when it got there.

Air versus Space

NACA explorers, unlike Columbus, had a good idea of where they were going. They were going into the air faster, farther, higher, and more efficiently in a modern engineering marvel that their systematic research into

Spaceflight Revolution



In this 1925 photo, NACA pilot Paul King, donned in a fur-lined leather flight suit with oxygen facepiece, is ready to test a Vought VE-7.

L-1118

aeronautics over the last 43 years had helped to make possible. Aeronautics and the NACA had grown up together; the business of the NACA for its entire existence had been to see that American aeronautics continued to progress. For NACA veterans who took Glennan's advice and read the Space Act of 1958, the time when the airways had been ruled by frail wooden biplanes covered with fabric, braced by wires, powered by heavy water-cooled engines, and driven by hand-carved wooden propellers did not seem so long ago. When 20-year-old Floyd Thompson served as a mechanic in Pensacola with the U.S. Navy's first torpedo squadron in 1918, the navy's fastest aircraft, an R6L biplane amphibian, had a top speed of 110 knots and a fuel system with a windmill on the outside to pump fuel up to an overhead gravity tank. When flight research operations began at NACA Langley a year later, NACA researchers hardly knew the principles of aeronautical engineering. Airplane design was still a largely intuitive and empirical practice, thus requiring bold speculation and risk taking. In 1920 the Langley staff copied the design of an existing wind tunnel at the British

National Physical Laboratory to fashion their Wind Tunnel No. 1 because no one at the NACA knew how to design a wind tunnel.²²

In the decades that followed, the NACA designed more wind tunnels than staff members could count (many of them unique facilities) and authored more reports on aeronautical technology than any other single institution in the world.²³ With the aerodynamic information that these tunnels and technical reports provided, American universities educated most of the country's aeronautical engineers, and U.S. industry became the world leader in the manufacture of aircraft. By NASA's first day, the NACA had helped to advance aeronautics far beyond the primitive state of flight at the end of World War I. Commercial jet airliners were beginning to fly passengers comfortably around the world in pressurized cabins. Sleek military jets streaked across the skies at speeds in excess of Mach 1, greater than the speed of sound. In fact, two McDonnell F-101A supersonic jet fighters were being made ready in the hangar for further flight testing. (The F-101A was nicknamed "Voodoo" but known to enthusiasts as the "One-O-Wonder.") Langley acoustics specialists Domenic Maglieri, Harvey Hubbard, and Donald Lansing were taking ground measurements of the shock-wave noise produced by one of the F-101As in level flight at speeds up to Mach 1.4 and altitudes up to 45,000 feet. A team of engineers and technicians supervised by Langley Assistant Director Hartley "Buster" Soulé, the NACA Research Airplane Project (RAP) leader, was evaluating several control systems for the North American XB-70 Valkyrie, a gigantic high-altitude, delta-winged bomber of some 550,000 pounds to be built of titanium and stainless steel and capable of flying to Mach 3.²⁴

As the federal agency responsible for the progress of the nation's aviation technology, the NACA had enough to do without getting involved in what the public considered "Buck Rogers stuff."* During the first four decades of Langley's operation, the idea of working to promote the immediate achievement of spaceflight had been too ridiculous for consideration. Into the 1940s, NACA researchers were not certain that rockets and missiles were a part of aeronautics. Langley veteran Christopher C. Kraft, Jr. (the "C" stood for "Columbus"), who later became famous as "The Voice of Project Mercury" and the director of NASA's manned spaceflight operations at Mission Control in Houston, remembers that before the late 1950s "space" was a dirty word: "[It] wasn't even allowed in the NACA library. The prevailing NACA attitude was that if it was anything that had to do with space that didn't have anything to do with airplanes, [then] why were we

* Younger readers may need to know that Buck Rogers was a science-fantasy comic strip created by Dick Calkins around 1930; the comic strip remained popular until it was terminated in the 1960s. In the 1950s, it also became a popular television "space opera." As such, "Buck Rogers" significantly influenced American popular culture's attitudes about rocketry and space travel. (In the late 1970s, another TV show, "Buck Rogers in the 21st Century," went on the air; however, the updated character did not bring on a similar craze.)

Spaceflight Revolution

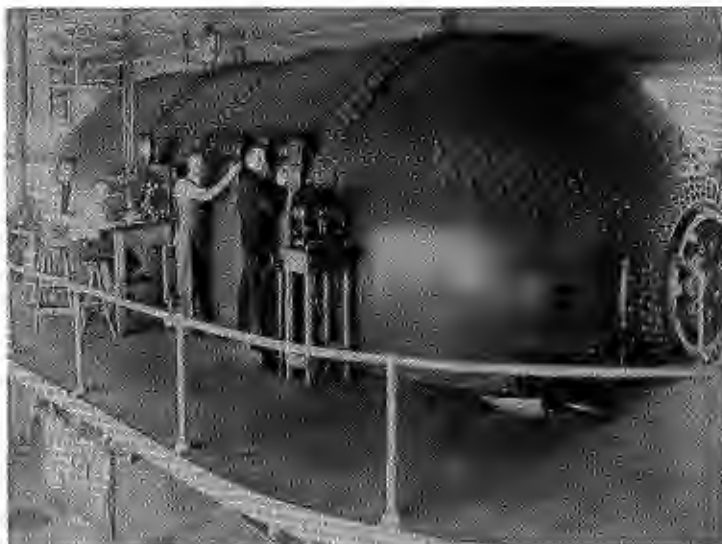

L-3310

In this photo taken on 15 March 1922, NACA researchers conduct tests on airfoils in the Variable-Density Tunnel, a revolutionary new test chamber that permitted, for the first time anywhere in the world, aerodynamic testing at approximately full-scale conditions.



L-37,931

Drag-cleanup testing of America's first jet airplane, the Bell P-59, is conducted in the Full-Scale Tunnel, May 1944.

working on it?"²⁵ One Langley veteran, Ira H. Abbott, recalled that the NACA stood "as much chance of injecting itself into space activities in any real way as an icicle had in a rocket combustion chamber." In the early 1950s, Abbott had mentioned the possibility of manned spaceflight to a House subcommittee, and one of the congressmen scornfully accused him of talking "science fiction."²⁶

Nevertheless, by the early 1950s, the NACA had become seriously involved in the study of rockets, missiles, and the potential of spaceflight; all of these topics related to aeronautics. Anything that concerned the science and technology of flight, whether it be in the atmosphere or beyond, eventually became an interest of the NACA. In the months following Sputnik, NACA leaders tried to capitalize on the agency's research into spaceflight to justify a central role in whatever space program came into existence. Acting prudently on behalf of their institution, the NACA Langley management and most staff members did everything possible to convince everyone concerned, including the new NASA administrator, T. Keith Glennan, that the old NACA laboratory could do and already was doing a great deal more than playing with airplanes.

For example, in January 1958, only four months after the launching of *Sputnik 1*, a special Langley committee, surveying current and pending projects, documented the NACA's transition to space research. Chairing the committee was Langley Assistant Director Robert R. Gilruth, the future head of Project Mercury, America's first manned space program. Also serving on this committee were Eugene Draley, head of the laboratory's Full-Scale Research Division (and soon to succeed Robert R. Gilruth as assistant director for the Dynamic Loads, Pilotless Aircraft Research, and Structures Research Divisions); John V. Becker, chief of Langley's Compressibility Research Division; and Charles J. Donlan, technical assistant to Associate Director Thompson. The in-house review covered the activities of all 11 Langley research divisions during fiscal years 1955 and 1957, as well as projected activities for fiscal year 1959. Two tables of numbers accompanied the committee's final report to Director Reid, and the more important of the two indicated that the "research effort" in the fields of hypersonics and spaceflight should increase from about 11 percent in 1955 to 54 percent in 1959; however, it was unclear what these percentages actually meant in terms of money and personnel hours. In fact, Langley management derived these percentages from hours spent on projects in the three research directorates.

According to the review, the two most important fields of application were satellites and spacecraft, and ballistic missiles. Efforts in these areas were to rise from less than 1 percent to 16 percent and from 3 percent to 14 percent, respectively. In the words of the committee members, "all research divisions are adjusting and reorienting manpower, curtailing work in areas of lesser importance [and] continually studying and developing the special facilities needed to attack these problems," and each division had been doing

Spaceflight Revolution

so for some time. "The ability to reorient the Laboratory's efforts to the extent shown in the brief time period considered," the report concluded, "is due to a considerable extent to active planning for a number of these [space-related] fields during recent years."²⁷

Langley senior management knew that these figures were authentic. The transition to space *was* happening at Langley, and it had been happening there even before Sputnik. Senior management also knew that more than a little finagling was done to get the space numbers up as high as possible, because they were doing the finagling. What was applicable to "space" and what was applicable to "aeronautics" depended on how they defined the research programs and divided the disciplines; to differentiate was splitting hairs. The Gilruth committee discovered, in January 1958, that much of the work at the laboratory, initially instigated to support what the NACA had always called the "aeronautics program," could in fact be conveniently reclassified as space research. In addition, Langley was working on many projects that honestly involved both aeronautics and space (truly "aero-space" research), yet could be classified as one or the other depending on what the center desired to emphasize.²⁸ In the post-Sputnik era of national debate over the makeup of a new space agency, now was unquestionably the time to emphasize space, an emphasis on which Langley's future would depend.

However, almost no one at Langley on the first day of NASA would have thought that the time had come to abandon the quest for improved aeronautical performance. Many great technological advances remained to be achieved in aeronautics: greater speeds, bigger airplanes, and superior flight efficiencies. Already in flight were radically new aircraft like Lockheed's supersonic F-104 Starfighter, the still-secret U-2 strategic reconnaissance "spy plane," and Convair's B-58 delta-winged bomber, which was capable of Mach 2. On the horizon were important developments, such as new helicopter applications, tilt wing, and other innovative vertical and short take-off and landing (V/STOL) capabilities. Additionally, new high-performance wings with unusual degrees of backward and even forward sweep were being designed at Langley and elsewhere. One of the wings of the future would probably have some form of variable sweep, like those Langley's foremost expert on high-speed aerodynamics, John Stack, had seen on a model of the arrow-winged Swallow aircraft in England. This wing would no doubt be part of a commercial supersonic transport (SST) that before too long would be taking airline passengers from New York to London or Paris in a few hours.²⁹ Even more dear to the heart of some aerospace enthusiasts was the first of the next generation of research airplanes, North American Aviation's rocket-powered X-15, designed for the exploration of the hypersonic speed regime up to Mach 6, as well as the hypersonic boost-glider program, known as Project Dyna-Soar, sponsored jointly by the U.S. Air Force and NASA. In one of these "envelopes," many NACA/NASA engineers felt, an American might first fly into space.³⁰

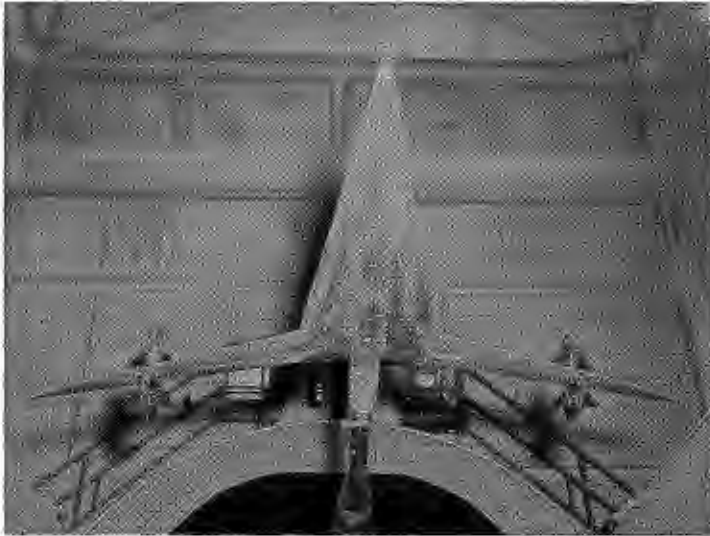

L-59-3817

A model of the Swallow arrow-wing aircraft is tested in the 16-Foot Transonic Tunnel in June 1959. The British hoped that a research airplane derived from the Swallow configuration would be the progenitor of a commercial SST.



L-58-2951

In 1958 two Langley researchers install a one-tenth scale model of the X-15 rocket plane in the Langley 7 × 10-Foot High-Speed Tunnel to study its spin characteristics.

Spaceflight Revolution

Clearly, now was no time to take a hiatus from aeronautics. Although many congressional leaders and probably even the American people as a whole forgot the second word in the National Aeronautics and Space Act, calling it “the Space Act,” most of the research staff at Langley took a different view. As preliminary drafts of the Space Act made their way to the NACA laboratory for review in the spring and early summer of 1958, aeronautically oriented staff members like RAP leader Hartley Soulé and supersonics pioneer John Stack read them and said to one another, “Well, we’re not doing that. Let those guys [up in Washington] go ahead and write it up, [but] we’ll just [keep doing] what’s necessary and get on with the program.” Unlike the ardent space buffs, these men read the Space Act to mean that they “were supposed to pick up the space program” in addition to aeronautics not that they “were supposed to get out of aeronautics.”³¹

A few days after passage of the Space Act, U.S. Army representatives visited Langley to find out who was going to take care of their aircraft engine problems now that the NACA was about to be dissolved in favor of a space agency. The surprised Langley people answered, “Well, we are! We’re here and we know what we are doing, and under NASA, we will just keep doing it.”³² That literal view of the Space Act calmed the military visitors and reassured their hosts. If Langley people had known that the national commitment to space was going to “backburner” their traditionally strong aeronautical programs for years to come, they might not have responded so glibly to questions about the changeover.

In the following years, the aeronautics effort at Langley decreased significantly; at its lowest level, it shrank to about 25 percent of the center’s total labor hours. Nonetheless, aeronautics was never allowed to die at Langley. Even during the rushed days of the Apollo lunar landing program in the 1960s, fruitful aeronautical programs quietly proceeded behind the scenes. Langley managed to retain a dedicated cadre of aeronautical people even when NASA recruited talent primarily in support of the space program. But for John Stack, Hartley Soulé, and likewise air-minded NACA veterans, aeronautical research would often seem nearly forgotten at Langley.

The Public Eye

Most of those working in aviation knew about the NACA through exposure to NACA reports and articles concerning NACA research in aeronautical engineering magazines and other trade journals. But none of the NACA’s operations had high public profiles, not even at the local level. Until 1958 most Americans knew nothing about the NACA. Before World War II, some congressmen did not know it existed. Even the people near Langley Field ignored the place. As Langley engineer and Hampton native Caldwell (pronounced Cad-well) Johnson remembers, “It [the NACA] wasn’t like NASA. The press didn’t care about it—to them it was a dull bunch

of gray buildings with gray people who worked with slide rules and wrote long equations on the board.” Brain-busters like that were better-off left alone.³³ Ironically, throughout its entire history, the only time the NACA was a high-profile agency was after Eisenhower had selected it as the nucleus for NASA.

At times the NACA’s obscurity put the agency at a disadvantage. The NACA could not rely on the strength of favorable public opinion in its campaigns for appropriations; such battles had to be fought and won quietly in private conferences in hallways or smoke-filled rooms with admirals, generals, and congressmen. These “gold-braided personages” made the case for the NACA to Congress, when it was necessary for a case to be made.

Handling much of this delicate politicking from 1919 until his retirement in 1947 was the NACA’s shrewd, cigar-smoking director of research, “Doc” Lewis (1892–1948). Although the gregarious Lewis and his successor, the quieter and scientifically sharper Dr. Hugh Dryden, usually acquired the necessary backing for NACA projects, they experienced many close calls. The closest one came in December 1932 when President Herbert Hoover, looking to reduce expenditures and increase efficiency in government, had ordered the NACA abolished and most of its resources handed over to the Bureau of Standards. However, House Democrats, anticipating the first term of Franklin D. Roosevelt, overrode the lame-duck executive order, and the NACA survived.³⁴

On balance, however, the advantages of the NACA’s invisibility outweighed the few disadvantages. It certainly benefited the researchers; most of them thought NACA Langley was a wonderful place to work and “just a splendid organization.”³⁵ Although administrative policies and bureaucratic guidelines involving anything related to the laboratory’s communication with the outside world (such as mail, telephone calls, and technical reports) were rather prescriptive, considerable leniency existed in the performance of in-house research. Individuals could follow their own ideas quite far without formal approval from superiors. Any scheme that survived peer discussion and won the approval of the research section was likely to be implemented. If funding was not formally available to build a given wind-tunnel model, flight instrument, minor test facility component, or the like, employees were usually able to “bootleg” what they needed from resources appropriated to approved projects. As long as the initiative offered something promising, did not cost too much, and did not have the potential to get the NACA into real trouble, NACA managers rarely complained or put tight reins on the researchers. Within the laboratory, few barriers limited innovation and the free dissemination of knowledge; the young engineers could discuss their work comfortably with everyone from the technicians in the shops to the division chief.³⁶

Such freedoms existed because neither the NACA’s own management, other government bureaucrats, nor newspaper or magazine journalists (or the American people as a whole) spent much time looking over the shoulders

Spaceflight Revolution

of NACA researchers. The NACA shared *what* it did with major clients; the *how* was kept more or less within the NACA itself. Moreover, almost none of NACA Langley's research work involved contracts with outsiders; everything was accomplished in-house. As Caldwell Johnson has noted about the NACA, "It had the best wind tunnels, the best model-builders, the best technicians, the most rigorous standards." Nothing gave Langley people more pride than being a part of such an autonomous organization.³⁷

If Langley engineers had cultivated any public image before NASA, it had been that of the "NACA Nuts." All the local hardware salesmen and auto dealers recognized them a mile away, and if it had not been for the federal paychecks that the NACA folks brought to the local economy, the natives would have dreaded to see them coming. Not only were most NACA Nuts overeducated Yankees, they were brilliant technical types who wanted to know the revolutions per minute (rpm) of their vacuum sweepers and ordered lumber cut to the sixteenth of an inch. Funny stories about their eccentricities abounded, leading everyone from Yorktown to Newport News to think that anyone from the NACA had to be either a weirdo or a screwball.

The truth was that most locals in those days had not the faintest idea what the NACA people did. Few residents even distinguished the NACA from the army (and later the air force) at Langley Field. Langley was all about flying and noisy airplanes that woke residents before their alarm clocks went off. But the people at the NACA were not concerned about the confusion. Being grouped with the soldiers in uniform was often useful camouflage. This camouflage was especially helpful during World War II when hard feelings were expressed by local families who saw their boys going off to war while NACA men were able to stay put because of a special deal made between the NACA and the Selective Service System.³⁸

In 1958 the natives still poked fun at the NACA Nuts, but they did so in a more friendly way. Previously, a friction similar to that felt typically between university "town and gown" had determined much about the Hampton-Langley relationship. The softening of hard feelings between locals and the NACA was due in large part to the marriage of many Langley engineers to area women and their subsequent assimilation into local society. For instance, the wife of Langley's number two man in 1958, Associate Director Floyd Thompson, was Jean Geggie, a native Hamptonian whose father carved wooden figureheads for ships at the nearby Newport News shipyard.

By the 1950s, NACA employees had become pillars of the community. Thompson himself had been a member of the Hampton Rotary Club for several years and had served on the board of directors of the local "Dixie General" hospital. (In the late 1960s, partly through Thompson's efforts, the hospital board voted to drop the racially inflammatory name "Dixie" and renamed the hospital Hampton General.) Furthermore, in the turbulent and scary weeks following the first Soviet space launches, the scientists and engineers "over at Langley Field" became reassuring figures. Here, right in their midst, many locals felt, were experts who could explain the meaning of

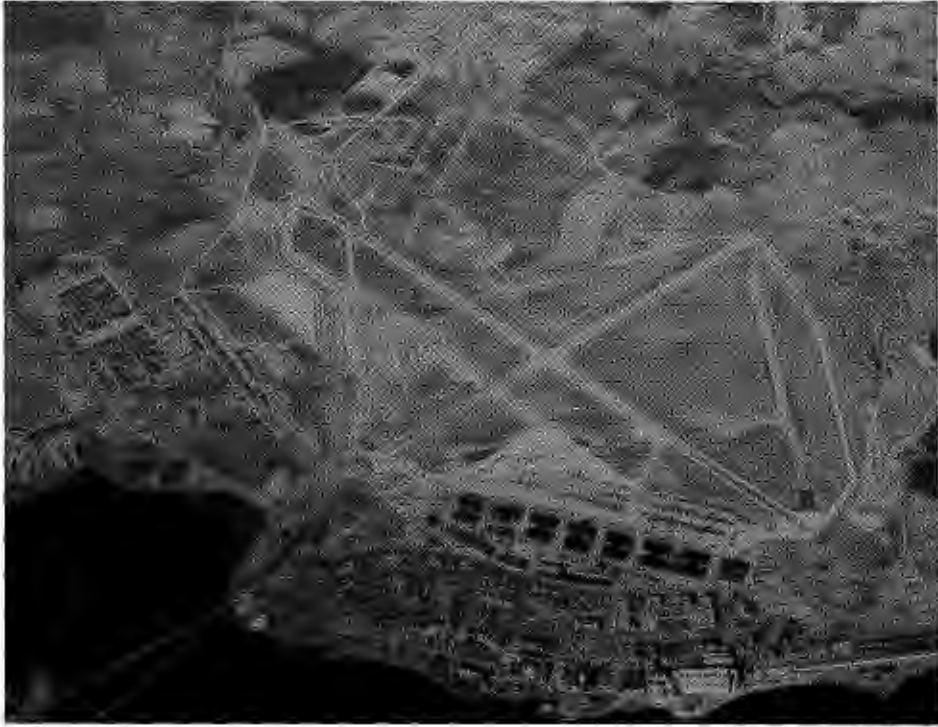

L-78,005

This 1950 aerial photo of Langley shows the original East Area along the Back River (bottom) and the West Area, constructed during World War II (top).

the foreign objects orbiting ominously overhead. Interviewed for stories by the local newspapers, NACA personnel discussed the progress of American space efforts and helped calm local hysteria. Hamptonians developed greater appreciation for the technical talents of Langley personnel, and the once tepid feelings about the NACA warmed.

With the transition to NASA, the public spotlight would inevitably shine on Langley. Personnel would soon figure out that the NACA attitude toward public relations had to change. In the old days, most NACA staff members could have cared less about public opinion. They only cared about the opinion of generals, congressmen, and other powerful people who could influence the budget and appropriation processes. With NASA, however, things had to be different. Beginning the day after the launch of *Sputnik 1*, researchers had to make their case before a much more concerned public. Without hesitating, they got right to it.

2

The First NASA Inspection

*It was, by all odds, a superlative display. . . .
Our sincere thanks for a superbly designed, brilliantly
mounted, and perceptive look at the very general goals
man must achieve before he becomes a space traveler.*

—Editorial, Newport News *Daily Press*
27 October 1959

On Saturday morning, 24 October 1959, a little more than a year after the metamorphosis of the NACA into NASA, approximately 20,000 visitors marched through the gates of Langley Field to attend a public open house that was being held in conjunction with NASA's First Anniversary Inspection. The NACA's first anniversary had passed unnoticed; NASA's proved to be a controlled mob scene.¹

The crowds came at NASA's invitation. Local newspapers and community groups had spread the word: for the first time in its 42-year history, Langley Research Center was admitting curious outsiders into the previously sheltered sanctuary of aeronautical research. NASA scientists, engineers, and technicians would show the public just what the new space agency had been doing to launch their country into space. Throughout the day, men, women, and children streamed through the huge NASA aircraft hangar as well as through two other large buildings full of exhibits that represented a cross section of NASA programs. Escorting the visitors was a handpicked group of articulate and polite NASA employees whose job was to handle the pedestrian traffic, guide the visitors through the buildings included in the program, and explain the exhibits.

The visitors moved "in fascination" past the many marvels on display.² They saw helicopters and aircraft, including a Chance Vought F8U-3 navy supersonic jet fighter used by NASA for sonic-boom research over Wallops Island; a Vertol 76, the world's first tilt-wing aircraft; a ground-effect vehicle designed to move over a cushion of air that the unusual craft created between its base and the ground; a display about the possibilities of SST flight

Spaceflight Revolution

(subsonic commercial jet flights across the Atlantic had only been made for about a year); a full-size mock-up of the air force/NASA X-15 rocket-powered research airplane; plus dozens of static and dynamic demonstrations involving wind tunnels, electrically powered models, electromagnetism, research instrumentation, as well as several examples of NASA technical reports.

Towering above all and attracting the most attention was a large fleet of space vehicles and rockets. This collection included a model of the original German V-2 rocket engine; a full-size version of the Thor-Able missile, which had been used to launch a number of U.S. space probes; a 19-foot Discoverer satellite to be used in polar-orbit research; a full-scale Little Joe rocket that was part of the Mercury program; a 72-foot Scout rocket to be used for general space research purposes; a six-stage rocket vehicle used for reentry physics studies at Wallops Island; and a 6-foot model of the world with orbital traces of the major satellites launched by the United States.

The public was so eager to see these wonders of modern technology that visitors had started forming lines around the exhibits as early as 8:00 a.m. even though the program was not scheduled to begin until 10:00 a.m., and they continued to swarm around the exhibits throughout the day. Most of the visitors were residents of the Peninsula area, but the license plates on some of the cars indicated that several had traveled from more remote parts of Virginia and a few had come from as far away as Georgia and Tennessee.³ For the NASA Langley staff, "The Nice NASA Show For The People," as one local editor called it, was quite an eye-opener. No one expected the general public to be so curious about NASA's research programs.⁴

After World War II, family members and friends of Langley personnel had been welcome on occasion to attend briefings and watch demonstrations "boiled down" from recently concluded NACA inspections (annual conferences for aeronautical insiders only). Never before the 1959 inspection, however, had Langley put on an open house involving more than just the center's employees and their families. Langley had neither a visitors' center (until 1971) nor any other regular means to handle many outsiders; none was necessary given the NACA's low profile and the limited public interest in what was going on inside a place that some locals referred to as "Sleepy Hollow."

The unprecedented public open house came at the end of a week-long closed affair modeled after the old NACA annual inspections. Up to 400 people a day had attended these NACA conferences. Although they came by direct invitation to learn about NACA programs, most guests already knew quite a bit about these programs because conference attendees were the patrons and clients of the NACA. Representatives from military aviation, the aircraft industry, and the airlines, and a few people from government

The First NASA Inspection



L-59-8075

L-59-8097

A mock-up of the Mercury space capsule appears to land by parachute on Langley's "Mercury Support" exhibit at the October 1959 event (top). At bottom left, Langley Director Henry Reid (middle), former Langley researcher and soon-to-be-named head of the new Office of Advanced Research Programs (OARP) at NASA headquarters Ira H. Abbott (right), and an unidentified guest stare up at the capsule mounted atop a model of the Atlas booster rocket. At bottom right, Langley Associate Director Floyd L. Thompson (middle), with Coke bottle in hand, and NASA Administrator Glennan (left) chat with guests and associates in front of the globe showing the orbital traces of previously launched American satellites.

Spaceflight Revolution

and the trade journal media had been the only visitors invited to the NACA inspections.*

No one at NASA headquarters had been sure whether to continue the tradition of the NACA inspection, which by the 1950s was rotating annually among Langley, Lewis, and Ames. The inspection was such a long-running show, having premiered at Langley in 1926, and its actors, settings, and stage directions were so closely identified with the NACA that some NASA officials wondered whether the event would serve the interests of NASA's new mission. But in the opinion of many others, including Dr. Hugh Dryden, NASA's deputy administrator, the inspection offered NASA an excellent means of publicizing what it had accomplished during its first year to achieve the nation's new objectives in aeronautics and space. "From a publicity point of view," read one NASA Langley document that outlined the general purpose of the proposed inspection, "the exhibits will present to the audience not only our aims and objectives, but the research background that led to the 'present-day' and future space developments." In other words, NASA could make the point, both directly and indirectly, that "pioneering 'in-house' research is a first prerequisite to successful aeronautic and space developments."⁵

Although this emphasis on in-house capabilities did not match Keith Glennan's agenda for NASA (Glennan wanted to see more research being done by outside contractors), the overall objective of the plan persuaded the administrator. He decided that, in October 1959, NASA would hold its First Anniversary Inspection, a sort of public show-and-tell event.

Because NASA was a new agency with different objectives and a much wider scope than its predecessor, a few things about the inspection were to be done differently. Not only was NASA to have an open house for the general public, it must also invite several foreign guests. While the NACA had discouraged their attendance, NASA had vested programmatic interests in (and mandated legal obligations to) foreign nations, which meant that some foreign scientists, diplomatic representatives, and members of the foreign press corps had to be invited to attend. At NASA headquarters, the Office of International Programs, under Henry E. Billingsley, and the Office of Space Flight Development, under Abe Silverstein, were in charge of issuing these invitations.

Although NASA had to aggressively pitch its program to the taxpayers, which meant packaging it as attractively as possible, the 1959 inspection was virtually the same ritual that the NACA had always orchestrated for the visitors. After registering at the base gymnasium starting at 8:00 a.m., the guests moved to an introductory session in the base theater from 8:50 to

* Some headquarters officials did not like the name "inspection," which had been in use since the 1940s. They argued that it did not accurately convey what happened in the program. They suggested "exhibition," "observance," "annual meeting," and a number of other substitutes, but none of these names was adopted.



L-59-8081

Administrator Glennan spends a few minutes in front of the Mercury capsule exhibit with Walter Bonney, NASA's first director of the office of public information. Bonney, who had worked for the NACA from 1949 to 1958, never found much favor in Glennan's employ. Glennan criticized Bonney harshly for his outdated, NACA approach to the public information field.

9:00 a.m. and from there went to a brief technical program in the cavernous test section of the Full-Scale Tunnel. Pinned to the coat of every guest was an identification badge with the person's name and tour group.

For the extended tour of the laboratory, Langley continued the old NACA practice of dividing the guests into color-coded groups, in this case into 10 groups of no more than 40 persons each. Each group had its own bus with a color-coded sign in the window, its own escorts and attachés, its own schedule to keep, and, at least in the minds of the inspection organizers, its own personality. NASA management wanted a mix of people in every group, but it also wanted the group members to be compatible. As expected, the gold group included dignitaries and VIPs. The brown and tan groups had the majority of the journalists, and the pink group included the few women who were invited. The red group comprised most of NASA's leaders. On the first day of the inspection, Tuesday, 20 October, Langley hypersonics specialist John V. Becker was the guide for the red group, which included Robert R. Gilruth, head of the new Space Task Group (STG); NASA Administrator Glennan; NASA Deputy Administrator Dryden; NASA Executive Secretary John F. Victory; NASA Goddard Director Harry J. Goett; NASA Ames Director Smith J. DeFrance; NASA Flight Research Center Chief Paul F. Bikle; Wallops

Spaceflight Revolution



L-59-7828

Four Langley secretaries serving as hostesses for the inspection take a look inside the cockpit of a full-size mock-up of the X-15.

Station Engineer-in-Charge Robert L. Krieger; plus several lesser officials from NASA headquarters. Also in the group were a few important men from the aerospace industry, the airlines, and the armed forces.⁶

Although some NASA personnel came to the inspection as guests, most came to Langley to report on the progress of the work at their respective centers. NASA Lewis sent an exhibit that demonstrated the relative merits of low-thrust space propulsion systems, including chemical, nuclear-hydrogen, and electrical rockets. NASA Ames contributed a display showing the physics of high-velocity impact in space and the potential dangers of meteoroid collision with spacecraft. For its part, the NASA Flight Research Center at Edwards AFB had contracted with North American Aviation for a mock-up of the X-15 and of the XLR-99 rocket engine along with a dummy pilot dressed in a pressure suit. The Jet Propulsion Laboratory (JPL) in Pasadena, California, formerly operated by the California Institute of Technology, had transferred to NASA in December 1958. The laboratory sent a small display and a team of scientists to present the story of the Vega rocket; at the time of the inspection, NASA thought that this three-stage booster would take a number of future vehicles and payloads into space, even into lunar orbit, but the proposed \$65-million development program would be cancelled only two months after the inspection. The new Goddard Space Flight Center was still a part of the Naval Research Laboratory (NRL) at its Anacostia location pending construction of an independent NASA facility

at Greenbelt, Maryland. Goddard contributed a display featuring several examples of lightweight inflatable structures that had applications for use in satellites and spaceflight.⁷

As was becoming to the host center, NASA Langley presented by far the greatest number and variety of exhibits. Langley staff built displays and gave illustrated talks on many space subjects: the nature of the space environment, reentry physics, and manned reentry vehicles such as ballistic capsules, high-drag gliders, and high lift-drag boost-glidors. Langley engineers also reported on aeronautical programs, notably the X-15, Vertol 76, and an SST airplane. Langley even supplemented Ames's display of high-velocity impacts in space with graphic results of its own experiments on the subject.

Following the NACA Way

According to the NACA's policy of triennial rotation among its three major research centers, it was "by the numbers" Langley's turn to host the 1959 inspection. However, NASA probably would have held the inspection there regardless of the rotation. The assistant chief of the Full-Scale Research Division and Langley's coordinator for the technical program, Axel Mattson, remembers with pride:

There was only one place that could put on that show. . . . There was no other place for it to go. . . . If it had been someplace else, the overall presentation wouldn't have been as good, and the emphasis might have been slightly different.⁸

In other words, Langley had the most experience in staging this event. Langley was also the oldest NACA facility and the NASA center closest to Washington, D.C., thus making it convenient to congressional and other powerful visitors. Perhaps most importantly, Langley was the place where the stars of the space program—the STG and its astronauts—were in training for the first U.S. manned space effort, Project Mercury.

Axel Mattson was a big, likeable, and loquacious engineer who loved the showmanship and conviviality of past inspections. In the weeks prior to the 1959 event, his job was to confer with the other NASA centers and to help them plan their participation in the inspection. In the cases of Ames, Lewis, Wallops, and the Flight Research Center at Muroc, Mattson's help was only minimal because the staffs at the former NACA facilities knew what an inspection demanded. They understood the rigorous standards for quality presentations and were ready for the customary competition among the centers for the best exhibits. All of the centers "tried to out-do one another" with the most sophisticated displays and demonstrations, Mattson recalls. "At least we thought they were sophisticated, let's put it that way."⁹

Spaceflight Revolution

The 1959 Anniversary Inspection was the first time that all the NASA facilities were participating, and those facilities included two that had not been part of the NACA—JPL and Goddard.* Mattson was responsible for encouraging the staffs of these new centers to develop appropriate and effective presentations for the inspection. “I had a dog and pony show,” Mattson remembers. “I took slides with me from previous NACA conferences” to show them what went on. He assembled the initiates in a conference room, making sure that people “with enough horsepower” to make the right things happen were in the audience, and then he briefed them on what an inspection was about and the purposes it served.¹⁰

Mattson tried his best to be polite and not to act arrogant while educating the non-NACA staffs about the do’s and don’ts of an inspection, but he still did not receive a warm welcome at either of the two non-NACA centers. In fact, at Goddard’s temporary home within the NRL, he feared he would “be tarred and feathered.” Typically, any organization that had been “navy” had superb loyalty among its staff and was very closed, even resentful of outsiders. In the opinion of the Goddard staff members, the inspection “was just something that the NACA did, and they didn’t think much of it.”¹¹

In particular, the navy personnel did not like the idea of rehearsals. In advance of NACA inspections, staff members customarily rehearsed their talks in their own research divisions and then sweated through another performance a week or so before the event as part of a fully staged dress rehearsal with center management and several key officials from NACA headquarters as the audience. For all the Washington office people to come down to Langley and critique the inspection material was a “big thing.” Dr. Dryden, John Victory, and others “all had a grand time with that.” Some laboratory employees complained privately about “having to put on a parade for their parents,” but most had reconciled themselves to the imposition. By 1959, NACA veterans like Mattson saw the NACA practice of rehearsals as the only way to guarantee the success of such a complex show. Mattson had to convince NASA’s new partners of the importance of all the planning and preparations. The staff at Goddard was unimpressed by Mattson’s explanations. A few of the more indignant told Mattson: “You won’t rehearse me. My gosh, I’m an expert, you know. Who’s going to critique what I say?” But Mattson held his ground and told them they

* The ABMA (Army Ballistic Missile Agency) under Dr. Wernher von Braun at the Redstone Arsenal in Huntsville, Alabama, did not become a part of NASA until their “shotgun marriage” was consummated by a vote of Congress in February 1960, but the decision to transfer the ABMA to NASA was actually finalized in October 1959, the month of the first NASA inspection. A number of ABMA representatives attended the NASA inspection. So, too, did the mayor of Huntsville.

The First NASA Inspection



L-59-7831

In this picture from the 1959 inspection, Axel Mattson (right) confers with John Stack, a devoted airplane man who surely experienced mixed feelings about the affair because of its emphasis on space rather than aeronautics.

would have to do it. Thinking back, Mattson calls his visits to the non-NACA installations “interesting sessions,” and he singles out the first NASA inspection as “the most difficult inspection of them all to put together.”¹²

Other NACA veterans have also commented on the difficulties of the new fraternal relationships within NASA. “There wasn’t any love lost between us,” remembers Langley’s Charles J. Donlan. “I really shouldn’t say ‘love lost’ because the people really didn’t know one another.” But “all the NRL guys” came “kicking and screaming into this new organization” that they thought was “going to be overwhelmed by the NACA bunch.”¹³ Everyone needed time to get over these psychological barriers and realize that they were all working as a team. A few people, some say particularly at Goddard, were never able to accept the partnership.

Strained interaction among NASA centers represents a key tension in the story of NASA that historians have not explored fully. In the first NASA inspection, a vestige of the old NACA culture won out over other integral parts of NASA; in the ensuing years, the culture of the NACA research laboratories, dominant in the early years of NASA, would in many ways be overwhelmed and superseded by those at the more hardware-oriented and operations-oriented spaceflight and spacecraft centers in Huntsville, Houston, and at Cape Canaveral. This turnabout, which would have seemed unlikely in the earliest days of NASA, was made inevitable by the large manned spaceflight programs of the 1960s and 1970s. The biggest bucks would be spent on the more industrial side of NASA, as they still are.

In the end, everyone at Goddard and JPL agreed to do their part in the 1959 inspection. As mentioned earlier, Goddard staff sent an exhibit that featured four erectable space structures, but they did so only after Langley

Spaceflight Revolution

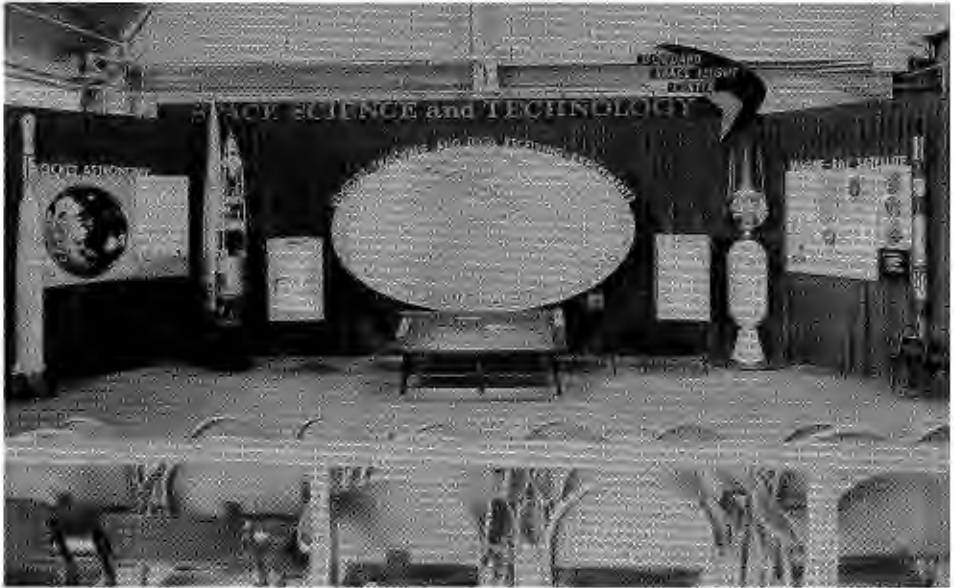

L-59-7275

The small exhibit area on space science and technology provided by the Goddard Space Flight Center.

had proposed that Goddard send an exhibit dealing with reentry physics. The JPL group sent an exhibit about the soon-to-be-cancelled Vega project. Both exhibits were prepared with the help of outside design consultants. The NASA representatives sent to Langley with those exhibits were “awful proud” of what they had done. “After all the trials and tribulations of getting them organized and getting them going,” Mattson states, “they walked around like peacocks” strutting their stuff and showing off their exhibits.¹⁴

Interestingly, after getting the new centers to cooperate and to do it the NACA way, some NACA veterans still found reasons to criticize. “For my money,” Smith J. DeFrance, the director of Ames, wrote to Henry Reid, the director of Langley:

the stops [on the tour] by your group were far superior to the Jet Propulsion Laboratory’s stop and especially the Goddard Space Flight Center’s stop. As you know, both of these were prepared by so-called specialists in the field of exhibition. Neither of the stops came up to the degree of perfection that was demonstrated by your own people.¹⁵

DeFrance had come to work at NACA Langley in 1922; Reid had come in 1921. They had followed the NACA way for so long that they found it

difficult to value any other. But Reid's answer did reflect an openness to the new NASA partnerships. "Letters are pouring in from many of the visitors," he wrote DeFrance, "and I feel that this inspection has certainly been very much worthwhile, not only because of the impression made on people outside our organization but also the impression made on many of our new members of the organization." Despite the problems convincing new members of the importance of an inspection, Reid summed up the experience as positive: "We were indeed very fortunate in having the excellent teamwork, even from our new organization, JPL." The teamwork of Goddard, to the extent that it materialized, Reid did not mention.¹⁶

Project Mercury

"Ladies and gentlemen, at this stop we shall discuss Project Mercury," announced the NASA engineer as another busload of visitors to the 1959 inspection found their way to the cold metal folding chairs set up in rows inside the West Area's Aircraft Loads Calibration building. Eight young members of the STG working in teams of two took turns giving this talk. The script of the presentation had been finalized just a day or two before the inspection to ensure an up-to-date report.

The STG speakers did not bother to introduce themselves (they had been told not to), and their identities would not have meant much to most people in the audience. They were Edison M. Fields and Jerome Hammack, Systems Test Branch; Elmer A. Horton, Control Central and Flight Safety Section; Milton B. Windler, Recovery Operations Branch; John D. Hodge, Operations Division; Carl R. Huss, Trajectory Analysis Section; John E. Gilkey, Engineering Branch; and Norman F. Smith, Engineering and Contract Administration. As it turned out, some of these men were destined to play major roles in NASA's subsequent manned space programs.¹⁷

"The possibility of venturing into space," the inspection talk began, "has shifted quite recently from the fantasy of science fiction to the realm of actuality. Today, space flight is considered well within the range of man's capabilities." Only five days after its establishment, NASA had formed the STG to design and implement, as quickly as possible, a manned satellite project. NASA put veteran NACA researcher Robert R. Gilruth, the former head of Langley's Pilotless Aircraft Research Division (PARAD), in charge; based the group at Langley; and named the Project Mercury after the fleet-footed Roman god of commerce, who served as messenger of the gods.¹⁸ The speakers proudly declared the mission of Project Mercury: to send "this nation's first space traveler into orbit about the earth," to study "man's

Spaceflight Revolution

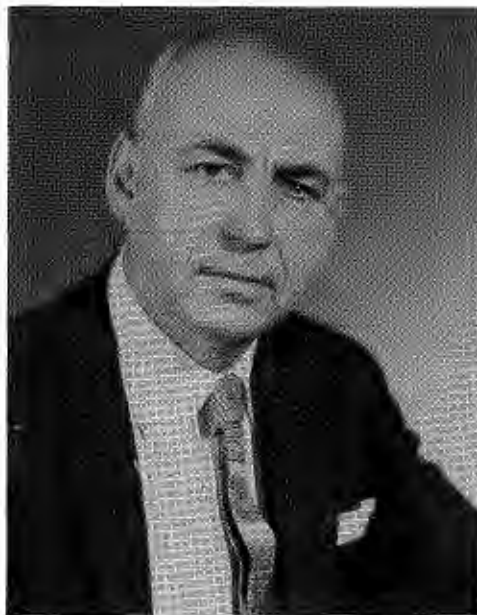

NACA veteran Robert R. Gilruth directed Project Mercury from offices at Langley.

L-59-57

capabilities in space flight,” and to assure “the safe return of the capsule and its pilot to the earth.”¹⁹

The STG plan was to send a small one-person spacecraft into orbit using the existing Atlas intercontinental ballistic missile as the launch vehicle and a ballistic reentry module as the crew capsule. After a few passes around the earth, retrorockets would fire to slow the satellite and thus initiate descent from orbit. After reentry into the atmosphere—accomplished safely thanks to the capsule’s blunt ablative heat shield—a large parachute would deploy to carry the capsule on its final approach and land it in the open sea. The capsule and the astronaut would be recovered by helicopter and brought home aboard a naval vessel.

The Mercury plan was a bold yet essentially conservative engineering concept, and it was to be almost unbelievably successful. By May 1963, it resulted in the successful launches of six Americans into space, thus leading to some two and one-half days of flight time in space. Although glitches and other vexing technical problems would plague virtually every Mercury mission, no major accidents occurred. “We were pretty lucky,” one leader of Project Mercury remembers. “In retrospect, we wouldn’t dare do it again under the same circumstances. But that’s true of most pioneering ventures. You wouldn’t dare fly across the ocean with one engine like Lindbergh did, either, would you?”²⁰

DEVELOPMENTS FOR MANNED FLIGHT IN SPACE

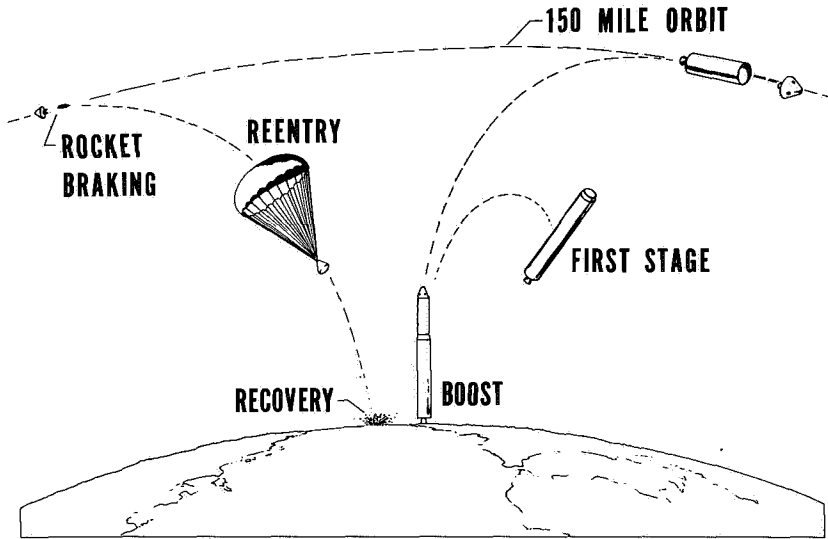

A diagram used at the first NASA inspection to illustrate the basic concept of a Mercury man-in-space mission.

Without question, the Project Mercury stop was the featured attraction of NASA's entire anniversary show. In 1959 everyone around the country was obsessed with beating the Soviets to manned spaceflight, and that obsession soon included the men who would actually pilot the spacecraft. Introduced to the public for the first time in April 1959, NASA's astronauts were not yet the golden boys they eventually became, but with the national media already bearing down on them and NASA's public affairs officers polishing the seven former test pilots' armor to a blinding shimmer, the future knights of spaceflight had already acquired star quality. They were national heroes before they did anything heroic. Some of their luster was lost in August 1959, if only temporarily, when the astronauts sold the exclusive rights to their personal stories to Time-Life for one-half million dollars. To most Americans this seemed an excessive amount of money; at that time the federal minimum wage was a mere \$1 an hour. The resulting controversy over the ethics of the deal was fueled largely by *Life's* legitimately disgruntled competition and did not really do much to damage the public's growing love affair with their handsome, if not yet "launched," astronauts.²¹

A few minutes into their talk at the Project Mercury stop, the STG speakers dimmed the lights and showed a short motion picture devoted to "the seven brave young men who have been chosen as the Mercury astronauts."²² First as a group, then one by one, the film introduced them,

Spaceflight Revolution



L-71-2971

The “Original Seven”: (left to right) Carpenter, Cooper, Glenn, Grissom, Schirra, Shepard, and Slayton.

just as each had been introduced with such flair during the sensational opening press conference at NASA headquarters on 9 April 1959. The “Original Seven” were Air Force Capts. Leroy G. Cooper, Jr. (later called L. Gordon), Virgil I. “Gus” Grissom, and Donald K. “Deke” Slayton; naval aviators Lt. Malcolm S. Carpenter (who preferred “M. Scott”), Lt. Comdr. Alan B. Shepard, Jr., and Lt. Comdr. Walter M. Schirra, Jr.; and Lt. Col. John H. Glenn, Jr., of the Marine Corps. Everyone knew that one of these men would soon be the first American, possibly the first human, to venture into space; one of the seven was destined to become the greatest technological hero since Lindbergh.

The Mercury astronauts were the survivors of an extraordinarily elaborate and rigorous search process that the STG had used to solicit applications from and to evaluate candidate astronauts. At the start nobody knew what sort or degree of skill, education, and training space pilots would need. So-called specialists in crew selection proposed that NASA choose the astronauts from “people in dangerous professions, such as race car drivers, mountain climbers, scuba divers, as well as test pilots.” But the STG was committed to the idea of test pilots from the beginning; with just any old breed of daredevil on board, the delegation of critical flight control and

command functions to the crew in the capsule would be much more difficult. When President Eisenhower decided that astronauts would be chosen from a military test-pilot pool, Gilruth and associates all “breathed a sigh of relief.”²³

A key person in the screening and final selection of the Mercury astronauts was Langley’s Charles J. Donlan. Formerly the free-lance technical assistant to Floyd Thompson, Donlan was now serving as Gilruth’s deputy. Working on a crash schedule basis, Donlan headed the NASA/Department of Defense (DOD) team, which included a psychologist on loan to NASA from the National Science Foundation. The team established the final seven evaluation criteria:

1. Less than 40 years old
2. Less than 5’11” tall*
3. Excellent physical condition
4. Bachelor’s degree in engineering or equivalent
5. Test-pilot school graduate
6. Minimum of 1500 hours flying time
7. Qualified jet pilot

Another Langley man who played a part in the screening process was Robert A. Champine, a veteran NACA test pilot who knew what kind of talents it might take to fly into space. Although not an STG member, he was part of the small NASA/DOD panel that evaluated the files of the nearly 600 military service test pilots who had applied for the astronaut positions. Of the seven evaluation criteria, experience as a test pilot was clearly the deciding factor.²⁴

Ironically, the greatest skepticism about the Mercury concept existed inside the family of test pilots. Pathbreaking NACA/NASA test pilots like A. Scott Crossfield, Joseph A. Walker, and even the young Neil Armstrong, who in 10 years was to become the first man to walk on the moon, were at first not in favor of Project Mercury. Their attitude was that the astronaut inside the ballistic spacecraft was no more than “Spam-in-a-can.” Charles E. “Chuck” Yeager, the air force test pilot who broke “the sound barrier” in 1947 in the X-1, expressed this prejudice: “Who wanted to climb into a cockpit full of monkey crap?”²⁵ This was a crude reference to the noble primates (such as “Ham” and “Enos”) who flew in the Mercury spacecraft prior to the astronauts and who went through some challenging and painful experiences to make the experience of humans safer and more certain.

By the time of the NASA inspection, all seven Mercury astronauts had been in training at Langley under the STG’s technical supervision (and Langley AFB’s administrative care) for about five months. Six of the seven moved into the area with their families: Carpenter and Cooper lived in

* The absence of a weight requirement is incredible given the demands of the payload on the launch rocket’s boosting power and the tight squeeze for the passenger inside the Mercury capsule.

Spaceflight Revolution

Hampton just across the tidal river from the air force base; Grissom, Schirra, and Slayton bought ranch-style homes within a few blocks of one another in the new Stoneybrook Estates subdivision of Newport News; and Shepard drove his white convertible through the Hampton Roads Bridge Tunnel each day from his family's home at the Naval Air Station in Virginia Beach. Glenn was the exception; while at Langley Field, he stayed in military base quarters and commuted to his home in Arlington, Virginia, on weekends to visit his wife and children. Already the local press was calling the astronauts "The Peninsula's Own" and trying to satisfy an adoring public's hunger for even the most mundane details of the astronauts' everyday existence, such as what kind of fruit juice they drank for breakfast.²⁶

The film shown at the Project Mercury inspection stop said little about NASA's selection of the astronauts and showed nothing about their personal lives; it concentrated on illustrating key aspects of their training for the upcoming Mercury flights. In one of the film's early scenes, the astronauts sat in a classroom listening to a lecture delivered by an STG engineer. This lecture was one in a series organized by STG member Dr. Robert Voas, the navy psychologist in charge of coordinating astronaut training. The lecture series was designed to introduce formally the astronauts to the Mercury program.²⁷ Although not depicted in the film, the astronauts also took a short course equivalent to graduate-level study in the space sciences. Henry Pearson, W. Hewitt Phillips, and Clinton E. Brown were among those engineers with special competencies in reentry physics, astronomy, and celestial mechanics and navigation chosen to teach the course.

While the astronauts learned a little about everything pertinent to the program, they were also trained to specialize in particular technical areas. Carpenter specialized in communications and navigation equipment; Cooper and Slayton concentrated on the liaison with the Army Ballistic Missile Agency (ABMA, later NASA Marshall Space Flight Center) and the launch vehicle suppliers; Glenn focused on cockpit layout; Grissom handled in-flight control systems; Schirra was responsible for life-support systems and pressure suits; and Shepard followed tracking range and recovery. Each astronaut was then responsible for briefing the other six periodically about what he had learned.²⁸

The inspection film of 1959 showed the Langley-based STG putting the astronauts through several spaceflight simulation systems and techniques to familiarize them with the Mercury capsule and evaluate the efficacy of astronaut capsule control. By this time in their training, the astronauts had already ridden on the end of the 50-foot arm of the centrifuge at the Naval Aviation Medical Acceleration Laboratory at Johnsville, Pennsylvania. The film showed one of the astronauts boarding what came to be known among the astronauts as "the wheel" because it resembled a medieval instrument of torture. Not even the grimacing face of the astronaut, as he desperately tried to operate a few manual controls, could communicate how miserable

the experience actually was for the rider, who was being pushed back in the seat as the wheel picked up speed, pinned there unable to move either arms or legs, breath forced out of the lungs, vision narrowing and darkening, and a sharp pain growing beneath the breastbone. John Glenn recalls, "At 16 Gs* it took just about every bit of strength and technique you could muster to retain consciousness."²⁹

The training at Langley was a little easier, at least physically. The astronauts made several "flights" in a closed-loop analog simulator that had been developed by the training devices section of the STG's Operations Division. This simulator had a basic configuration similar to the X-15 attitude control system simulator that had been built earlier at Langley. At the time of the October 1959 inspection, it contained a simple chair with a sidearm controller and rudder pedals.³⁰ A later version would have a three-axis controller and a molded couch like those individually fitted for each astronaut for the actual Mercury missions. The function of this couch, which was one of many ideas supplied by the STG's brilliant Maxime Faget, was to protect the astronaut against the high G-forces during launch and reentry. In one scene of the film, two of the finished couch forms were visible in the background; in tests at the Johnsville centrifuge, such couches had proved effective for loads of more than 20 Gs. The movie also featured a sequence in which an astronaut used the sidearm controller to move his chair through various changes in pitch, roll, and yaw, and a scene showing an overheated astronaut in a full pressure suit undergoing what the speaker called "elevated temperature elevation."³¹

"The Space Task Group has found the seven astronauts inspiring young men with whom to work," speakers told the audience. To equip them with the "detailed knowledge and skills that the pilot of a pioneering orbital space capsule must possess," NASA was putting them through "an extensive program of training, indoctrination, and specialized education." And rest assured, the speakers told the audience, the astronauts were preparing for their upcoming launches into space "with an enthusiasm and a maturity that are vital in a program of such importance to our nation."³²

The speakers did not mention that the astronauts sometimes felt they were being treated like guinea pigs. This was not the case in their dealings with the STG at Langley. As the astronauts later attested, the STG treated them as "active and valuable participants in the safe operation of the machine." Bob Gilruth and his staff had been dealing directly with test pilots in NACA aircraft research programs since before World War II. These years of experience contributed to a relationship with the astronauts that was built on respect.³³

Much to the disappointment of many in the audience at the NASA open house, especially the young people, the living, breathing astronauts were nowhere to be seen. Neither Gilruth nor anyone else responsible for

* "G" is the symbol representing the acceleration due to gravity.

Spaceflight Revolution



L-59-4426

Molded astronaut couches line the Langley model shop wall. The names of the test subjects—Langley employees—are written on the backs.

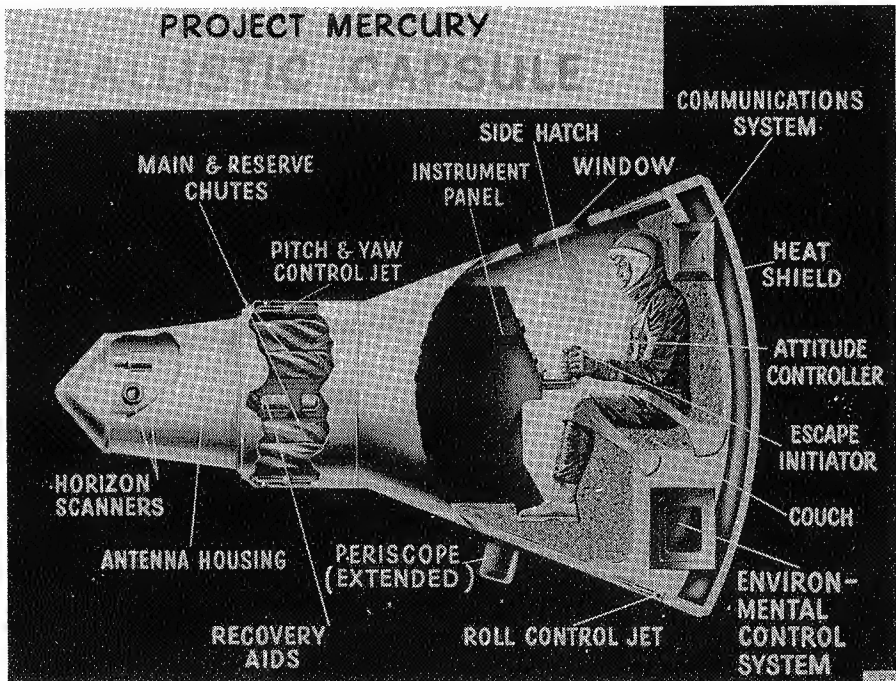

L-61-5741

This cutaway drawing was used by the STG to explain the Mercury ballistic capsule to visitors at the first NASA inspection.



Astronaut John Glenn sits within the cozy cocoon of the Mercury spacecraft.

the astronauts wanted to add to the astronauts' already heavy schedule by keeping them in front of several thousand sticky-fingered and camera-clicking fans for an entire Saturday. The astronauts' training at Langley included a rigorous regimen of physical exercise, including skin-diving operations designed to simulate weightlessness and the kind of sensory disorientation that they might experience during reentry from space. In Langley's large hydrodynamics tank (Building 720) as well as in the brackish water of the Back River, an inlet of the Chesapeake Bay behind the East Area, the astronauts were learning to get out of the space capsule as it floated in water. Along with the tiring training at Langley, the astronauts also made trips to the Johnsville centrifuge; to Cape Canaveral, where the countdown for their manned orbital flights would be made; as well as to the McDonnell Aircraft Corporation plant in St. Louis, where the Mercury capsules were being built.

Although the astronauts were excused by NASA from appearing at the open house, they had participated in the inspection earlier in the week. They were not assigned to give speeches or conduct tours, but they were asked to mix with invited guests in the major exhibit hall within the large aircraft hangar, where the makeshift after-hours wet bar called "19th Hole" was set up and most socializing occurred.

Spaceflight Revolution

John Glenn, who in three years would become the first American to orbit the earth (20 February 1962), explains a feature of the Mercury capsule to his wife, Annie Castor Glenn, whom he had known since his New Concord, Ohio, childhood.



L-59-7859

Big Joe, Little Joe

The success of two recent tests for Project Mercury lent a cautiously upbeat mood to the First Anniversary Inspection. Five weeks earlier, on 9 September 1959, the project reached an important early milestone with what the inspection speakers called the “highly successful firing” of “Big Joe.” Big Joe was a one-ton, full-scale instrumented mock-up of the proposed Mercury spacecraft designed to test the efficacy of the ablative heat shield and the aerodynamic stability of the capsule design. Speakers at the Project Mercury stop boasted that the Big Joe project had not begun until December 1958 and was flying successfully only 10 months later.³⁴

After showing a short movie of Big Joe’s launch atop an Atlas D booster from Cape Canaveral, the STG engineers explained that although the launch was normal, the two outer booster engines failed to jettison as planned because of a malfunction; the capsule-Atlas combination rose to an altitude of only about 100 miles. This was nevertheless high enough for the capsule, once separated from the Atlas, to fall back to earth in conditions that closely simulated orbital reentry. Another short movie showed the shipboard recovery of the capsule by a navy destroyer. The STG speakers explained that the recent Big Joe test not only proved to be an excellent exercise for the military recovery teams but also provided data that confirmed that the

blunt-body capsule shape had performed as predicted in NASA wind-tunnel and other laboratory studies. In their words, the Big Joe test was “the first major step” in proving that the Mercury design concepts were feasible.³⁵

On display in the Aircraft Loads building was the recovered capsule; alongside it was a second Big Joe boilerplate capsule mounted on a Little Joe booster mock-up. NASA Langley was proud of Big Joe. A small group of Langley technical service people under STG’s Jack Kinzler had actually fabricated the capsule’s afterbody, including the upper heat shield and the parachute deck, while another NASA group under Scott Simpkinson at Lewis had made the lower part of the capsule, the instrumentation, the controls, and the rest of the heat shield. But Langley positively doted on its Little Joe. Little Joe was an innovative solid-fuel rocket, one of the earliest U.S. launch vehicles based on the principle of the clustered rocket engine. (The Soviets were already “clustering” the more complex and troublesome liquid-fuel rocket engines.) STG engineers Max Faget and Paul Purser, then of Langley’s PARD, had conceived Little Joe as a space capsule test vehicle even before the establishment of NASA and the formation of the STG. Gilruth understood the importance of the Little Joe tests: “We had to be sure there were no serious performance and operational problems that we had simply not thought of in such a new and radical type of flight vehicle.”³⁶ A launch of Little Joe on 21 August 1959 had failed, but at Wallops Station on 4 October 1959, just two weeks before the inspection, NASA successfully fired one of the “little” test rockets to an altitude of about 40 miles over the Atlantic Ocean before intentionally destroying it.³⁷

“Little” was relative, of course, because the rocket stood 50 feet tall, weighed 28,000 pounds—the gross takeoff weight of a Douglas DC-3 airliner—and had a cluster of eight solid propellant engines that produced a quarter of a million pounds of thrust at takeoff. Nor did “little” accurately describe Little Joe’s importance to the Mercury project. For the 4 October launch, neither the capsule nor the escape rocket had been instrumented, but Little Joe would carry instrumented payloads to varying altitudes, thus allowing NASA engineers to check the operation of the escape rocket and recovery systems. This they could do from Wallops Island before proceeding to the more expensive and difficult phases in the latter part of the program at Cape Canaveral. In ensuing months, Little Joe rockets (models I and II) also provided information on flight stresses as they related to “biological payloads.” The first of these payloads was Sam, a 7-pound Rhesus monkey launched from Wallops on the nose of a Little Joe on 4 December 1959. Surviving a violent ride up and down from a height of 55 miles with a parachute landing into the Atlantic Ocean, Sam gave NASA flight engineers a better idea of how human astronauts would fare during their upcoming Mercury flights.³⁸

To the public, Project Mercury looked to be proceeding smoothly. The major setback of July 1959, when the first Atlas-Mercury production vehicle failed structurally under launch loads at the Cape, was not mentioned

Spaceflight Revolution



L-59-4946

Langley technicians constructed the Little Joe capsules in-house in Langley's shops (top). A crane swings a capsule into place atop Little Joe in preparation for a launch at Wallops Island (right).



L-59-5134

The First NASA Inspection



Langley's Little Joe rocket blasting off (left) from Wallops Island in the fall of 1959. Max Faget thought that Little Joe could be made reliable enough to carry a man, but, Gilruth eventually scrapped the idea, deciding to use Redstone and Atlas. Below, the Little Joe capsule is recovered at sea.

L-59-8427

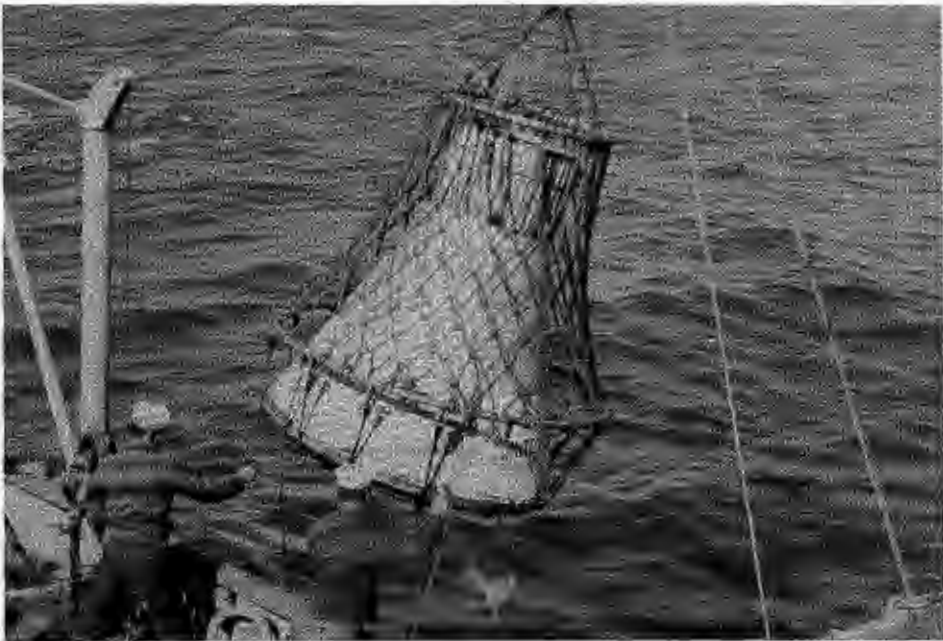

L-64-6455

Spaceflight Revolution

in Langley's open-house presentation. To everyone behind the scenes at Langley, Project Mercury was in fact advancing at breakneck speed. In the period between early October 1958 and mid-January 1959, specifications for the Mercury capsule had been prepared and sent to the aerospace industry with a Request for Proposals; the bidders had been briefed; all the source selection (evaluation of proposal) activity had taken place; and the contract had been placed. That was not all. During the same period, the STG procured Atlas rockets and launch services from the air force; worked out a plan with the army (and Wernher von Braun's rocket team in Huntsville) for Redstone boosters; drew up the specifications for Little Joe; tested escape rockets over the beach at Wallops; and were in the midst of a wide range of tests at Langley. The STG also had to present technical reviews of the project to NASA headquarters officials approximately every two months. To do all this, every member of the STG worked holidays, evenings, and weekends. "These were the days of the most intensive and dedicated work [by] a group of people that I have ever experienced," Gilruth recalls proudly. This kind of performance could have occurred only "in a young organization that had not yet solidified all of its functions and prerogatives."³⁹

This performance could have happened only in an organization whose staff members did not know—or care to know—the difference between the possible and the impossible until they found out for themselves.

3

Carrying Out the Task

There are no billboards heralding the birthplace of the Nation's [space] program. There are no colorful banners proclaiming it the homebase for the U.S.'s seven astronauts. Yet nestled at one end of the historic Virginia Peninsula, a small group of buildings were the setting for the most penetrating research and development programs of our time. . . . It was here at the NASA Langley Research Center that America took its first step into space.

—Virginia Biggins
Newport News Daily Press

For Bob Gilruth, the chief operational officer of the U.S. manned space program, NASA's First Anniversary Inspection meant only a brief respite from the torturously hectic schedule he had been following for more than a year. As head of Project Mercury, he had given dozens of talks and had answered thousands of questions in the past 15 months about America's highly publicized enterprise to send a man into space. He had made presentations before Congress, to Dr. Killian and the rest of the President's Science Advisory Committee, and to the senior staff of the Advanced Research Projects Agency (ARPA) including agency heads Roy Johnson and Dr. Herbert York.* "Some of these gentlemen were not at all enthusiastic about our plan to put a man into space," Gilruth later acknowledged. In fact, Presidential Science Adviser Dr. George Kistiakowsky had remarked with great displeasure that the plan "would be only the most expensive funeral man has ever had."¹

* The secretary of defense had established ARPA in January 1958 to run U.S. space programs on an interim basis until NASA was established.

Spaceflight Revolution

But at least during the anniversary inspection the pressure was off; officially, Gilruth was just one of the guests touring with the red group. At the Mercury stop, the eight men from the STG had to put on the good show that everyone had come to expect, and for once he could sit back and listen to someone else do the talking.

For the balding 45-year-old aeronautical engineer from Nashawauk, Minnesota, Project Mercury had started in the hot summer of 1958 while on assignment in Washington, D.C. Dr. Hugh Dryden had needed help putting together a plan and a budget for the new space agency, and Gilruth, with about 20 senior men from Langley and the other NACA laboratories, went to lend a hand. Eisenhower had not yet given specific responsibility for management of the nation's manned spaceflight program to the soon-to-be NASA, nor had he officially named Glennan the NASA administrator. Abe Silverstein, subsequent head of space projects at NASA headquarters, had not yet come up with the name "Mercury" for the proposed manned satellite project. In one large room on the sixth floor of the NACA headquarters, Gilruth and associates worked feverishly through the muggy midsummer to put together a plan for a man-in-space program that would be acceptable not only to the reincarnated NACA but also to ARPA, the president, and his scientific advisers.²

"In order to do this," Gilruth remembers, "I collected a select group of people . . . to form a sort of task force." The members of this original group included Langley's Max Faget, head of the Performance Aerodynamics Branch of PARD; Paul Purser, head of the High Temperature Branch of PARD; Charles W. Mathews, head of the Stability and Control Branch of the Flight Research Division; Charles H. Zimmerman, assistant chief of the Stability Research Division; and three men from Lewis. These men were called from the 10 telephones specially installed in the NACA's big sixth-floor room and were told to "be in Washington tomorrow afternoon." As Zimmerman remembers:

I said, well, what for? [The voice said,] "I can't tell you what for." Who am I supposed to see? [The voice said,] "Just be in the Washington office tomorrow morning." I went to the Washington office and I stayed there three or four months. . . . I wasn't told anything, just be there. I had to go and tell my wife I'm going. [I] didn't win a popularity contest that day.³

Gilruth brought in several other NACA engineers for consultation when their expertise was needed. He called in PARD's top engineering designer Caldwell Johnson, who had been hired by the NACA as a model builder in 1937 at the age of 18; Johnson's job was to put the first design of the Mercury capsule on paper. The result was an elegant series of freehand pen-and-ink sketches that artistically put many detailed engineering drawings to shame. Near the end of the summer, two more engineers from Lewis and one from Langley, Charles Donlan, joined the group to finalize and fine-tune the Mercury plan.

The work of the task force turned out well both in the short term and the long run. Thinking back on the substance of these early talks about what came to be Project Mercury, Gilruth would be impressed by how closely the STG was able to follow the original plan of that summer: "We said we would use the Atlas rocket; a special space capsule with a [NACA-proven] blunt heat shield; and parachutes for a landing at sea. All these things were to work out very much as we proposed."⁴ During that hot summer of 1958, Max Faget, Caldwell Johnson, and Lewis's Andre Meyer also came up with the idea of an escape rocket to enable the capsule to get away from a malfunctioning launch rocket, and Faget conceived the form of the contour couch, which would help to protect the astronauts against the high G-forces during launch and reentry.

Much about the group's Mercury concept was not all that new: the aerodynamic benefits of the blunt-body shape had been discovered (at least for ballistic nose cones) by H. Julian "Harvey" Allen and Alfred J. Eggers at NACA Ames in the early 1950s.⁵ Since then, several important notions about ballistic reentry vehicles had been germinating in the minds of Gilruth's colleagues in PARD, notably in the brilliant one belonging to the outspoken Max Faget. (Because he was one of the most intuitive researchers on the Langley staff, jealous colleagues jibed that his name stood for Fat-Ass Guess Every Time.) By the launch of *Sputnik 1*, Faget had proposed that a simple nonlifting shape, if properly designed, could follow a ballistic path when reentering the atmosphere without overheating or accelerating at rates dangerous to the astronaut. Drag would slow the capsule as it reentered the atmosphere. Furthermore, the shape—though basically nonlifting—could generate the slightest amount of aerodynamic lift necessary to permit the capsule to make one or two simple maneuvers during reentry. Faget had made some rough tests to prove this theory. From the balcony overlooking the PARD shop, he had flipped two paper plates that had been taped together into the air. "I thought he was crazy at first," remembers fellow PARD engineer J. Thomas Markley. "Max, what are you doing?" asked Markley in amusement. Faget answered, "I think these things will really fly. We really have some lift-over-drag in this thing."⁶

A few months after the paper-plate toss, at the last NACA Conference on High-Speed Aerodynamics held at Ames in March 1958, the feisty 5-foot-6-inch Faget gave a talk entitled "Preliminary Studies of Manned Satellites—Wingless Configuration: Non-Lifting," which was coauthored by Langley's Benjamin J. Garland and James J. Buglia. In the talk Faget put forward most of the key items that NASA would later use in Project Mercury: a ballistic shape weighing some 2000 pounds and having a nearly flat-faced cone configuration, small attitude jets for controlling the capsule in orbit, retrorockets to bring the capsule down, and a parachute for final descent. "As far as reentry and recovery are concerned," Faget concluded his talk, "the state of the art is sufficiently advanced so that it is possible to proceed

Spaceflight Revolution

confidently with a manned satellite project based upon the ballistic reentry type of vehicle.”⁷

Not everyone was so confident. In the wake of Sputnik, several interesting concepts for manned satellites had popped up. Some advocates of these alternatives disdained Faget’s proposed ballistic approach because, as Gilruth explained, it represented “such a radical departure from the airplane.”⁸ This man-in-the-can approach was too undignified a way to fly. Many concerned with America’s new space program searched for another plan: Couldn’t a pilot fly into space and back in some honest-to-goodness flying machine? Why not doctor the X-15 so a pilot could take it into orbit and back without burning up? Or why not push to quickly build one of the hypersonic gliders that had been drawn up on paper? One of the most innovative concepts for such a space plane, proposed by Langley’s Chuck Mathews, called for a craft similar to NASA’s later Space Shuttle. Mathews’ plane would have a circular wing and would glide back from space at a high angle of attack. During reentry, most of the intense heat caused by the friction would therefore be confined to the wing’s lower surface. Upon reaching the atmosphere, the vehicle would pitch over and fly to a landing like a conventional airplane.⁹

Such concepts sparked much interest in the months after Sputnik. Gilruth and the rest of the team planning for Project Mercury considered the merits of each one separately. Several of the ideas could have been made to work in time, but the new space agency did not have time to spare. Everything indicated that the Soviets were intent on launching a man into space, and the United States was determined to beat them to it. The Atlas rocket, the most powerful American booster at the time, was not capable of lifting more than about 2000 pounds into orbit, which ruled out the hypersonic glider concepts. Furthermore, even the Atlas was still horribly unreliable. Only one out of eight Atlases had been launched successfully; the other seven had staggered off course or blown up. If the United States wanted to win this important second leg of the space race, waiting for the development of a bigger and more dependable missile capable of lifting the far greater weight of a small space plane did not make sense. “It seemed obvious to our group,” Gilruth would explain many years later, “that only the most simple ballistic capsule could be used if manned spaceflight were to be accomplished in the next few years.”¹⁰

Several options may have been more technologically attractive to some NASA engineers, but Faget’s plan appeared the best to achieve America’s immediate space objectives. In some respects the plan was an ungainly (some have said unimaginative, even ugly) way to send an American into space, yet in 1959 it seemed the only way to do so quickly. As Gilruth would say later, Project Mercury

wasn’t pretty like a flower or a tree. But it had no bad traits. It was designed as a vehicle for a man to ride in, and circle the earth. With its blunt body, its retrorockets and parachutes, it was an elegant solution to the problem.¹¹

But a solution that was elegant in conception had no guarantee of becoming a practical success. Once ARPA heads Roy Johnson (a former General Motors executive) and Herbert York (a distinguished atomic physicist) approved the plan on 7 October 1958 and NASA gave the go-ahead, Gilruth and his people were left with the job of making Project Mercury work.

A Home at Langley

Gilruth and associates returned to Langley Research Center from the nation's capital in mid-October 1958 and immediately began to contend with the unknown challenges of putting together an organization that could manage an operation much bigger, more complicated, and far riskier than any previously undertaken by the NACA. In approving the project, Keith Glennan's comment had been, "All right. Let's get on with it." Bob Gilruth remembers that at the time he "had no staff and only [oral] orders to return to Langley Field." When Gilruth politely pressed the administrator for some details about how he was to implement the plan in terms of staffing, funding, and facilities, Glennan reiterated brusquely, "Just get on with it."¹²

Gilruth's yet-to-be-built organization was given temporary quarters at Langley, where it would act, again temporarily, as a quasi-independent NASA field unit reporting directly to Abe Silverstein's Office of Space Flight Development in Washington. Though Langley lacked management control over the new group, the center's support of the task group's ambitious program proved remarkably strong.

Almost everything about the initial organization and early operation of Gilruth's group happened catch-as-catch-can. Even the name of the STG itself suggested a makeshift character, as if NASA did not want to raise expectations too high about meeting the Soviet challenge. One STG member suggests that the choice of the title "Space Task Group" amounted to a "conscious effort to put the work in proper perspective and avoid grandiose organizational concepts at a time when satellite development experience was limited to basketball- and grapefruit-sized objects."¹³ The timid nomenclature might protect NASA if the manned satellite program did not work as planned. NASA could say that only one *task* failed; the rest of NASA's operation was proceeding nicely.

Excluding Bob Gilruth, the most important person behind the formulation of the STG was Langley's Floyd Thompson. Although still nominally the laboratory's number two man, Thompson had been serving as the director for some time because of Henry Reid's rather relaxed approach to his impending retirement. According to Gilruth, Thompson "was all for me, because he knew that if we didn't succeed, NASA wouldn't succeed." He realized that Gilruth would need substantial center support until the slow-grinding paper mill at NASA headquarters made alternative provisions. Thus, when Gilruth asked Thompson how he could get the men and women

Spaceflight Revolution

he needed for the STG, Thompson told him simply to write a short memorandum stating that he had been authorized by Administrator Glennan to draft personnel. Gilruth wrote that memo on 3 November 1958 and personally took it down the hall to the associate director's office. The letter amounted to one brief paragraph:

The Administrator of NASA has directed me to organize a space task group to implement a manned satellite project. This task group will be located at the Langley Research Center but, in accordance with the instructions of the Administrator, will report directly to NASA Headquarters.¹⁴

For the project to proceed with the utmost speed, Gilruth proposed to form his group around a nucleus of key Langley personnel, the majority of whom had already worked with him on the project at NASA headquarters.

Thompson did not want to run the STG himself, because he recognized that a quasi-independent person like Gilruth, not a center director, was "the best guy to do it."¹⁵ At the same time, Thompson wanted Gilruth, a personal friend, to have a circle of bright and trustworthy individuals around him. In particular, Thompson felt Gilruth should have a good, solid deputy, so he gave him Donlan, his own energetic assistant.* For the past seven or eight years Donlan had been enjoying the enviable job of probing, at his own discretion, into different areas of the laboratory's research programs and acting as its technical conscience. "Thompson thought Gilruth needed me, because Bob liked to play around with ideas and not pay too much attention to the actual running of the technical functions," Donlan states. So, "for the first time in [my] professional career," Thompson told Donlan, "[I] am going to make a recommendation." Thompson asked Donlan to join the STG as Gilruth's deputy.¹⁶

Gilruth's terse memo created a rapidly expanding core group of space pilgrims. According to one cynic, these pilgrims were like those who came to America on the *Mayflower*, "considering how many people tell you they were in it."¹⁷ But Gilruth asked by name for the transfer of only 36 Langley personnel plus 10 engineers from Lewis laboratory. Lewis provided rocket-engine and electronic engine-component specialists—the experts in aerospace propulsion systems that Langley lacked.

Fourteen of the 36 Langley personnel belonged to PARD. This major and quasi-independent division of the laboratory had been headed for a time in the early 1950s by Gilruth. The work of PARD had always required the management of flight operations (albeit pilotless ones) and had dabbled with hardware development. While studying the aerodynamics of various missiles and missile nose-cone configurations during the past

* Later on, Thompson would "feel an obligation" to bring Donlan back to Langley, making him Langley's associate director in March 1961. Donlan stayed on as associate director (later renamed deputy director) until May 1968 when, at the request of the NASA administrator, Donlan transferred to NASA headquarters and became the deputy associate administrator for Manned Space Flight.

few years, PARD engineers had established launch procedures at Wallops Island, experimented with the principles of rocket staging, developed key technologies for missile guidance and control systems, and built or refined sensitive instrumentation for telemetry studies. They had also supported manned satellite proposals from the Defense Department. In 1957 and early 1958, before ARPA/NASA approval for Project Mercury, PARD engineers had given research support for Project MISS, the unfortunate acronym of the “Man-in-Space-Soonest project,” an air force concept for simple manned orbital flights that in some technical respects presaged the Mercury concept. This early work in support of the manned satellite proposals had taken the PARD engineers into such areas as space environmental controls, communications systems, and heat-shield technology. Having had this experience, many members of PARD were not as concerned as other Langley employees about the possible compromise of traditional laboratory research functions implicit in heavy involvement in Project Mercury. In terms of technological expertise and organizational culture, PARD people were the most naturally inclined at Langley to become involved in the planning and management of NASA’s manned spaceflight program.¹⁸

Of the remaining 22 STG staff members recruited from Langley, 10 were from research divisions other than PARD; 4 had been working in the Fiscal Division, central files, or in the stenographic pool; and 8 were either secretaries in PARD, stenographers, or “computers” (operators of the calculating machines). Thompson agreed to give Gilruth all the people he asked for, save one: a young electrical engineer, William J. Boyer. The Instrument Research Division (IRD) wanted to keep Boyer, and he was not anxious to be transferred. The head of that division, Edmond C. Buckley, finally found a satisfactory replacement in Howard C. Kyle.

Most of the original STG crew signed up voluntarily; they were young, relatively unestablished, and they relished the challenge. At ages 45 and 42, respectively, Gilruth and Donlan were experienced enough to recognize the difficulties of the job ahead, but many of their subordinates were naive about the ways of the world and did not consider the serious hazards facing them. Jack Kinzler, a skilled master craftsman in the West Area machine shop, recalls that he had grown “so consumed with space” after Sputnik that he just dropped everything when Gilruth called him to join the group. After accepting the transfer, Kinzler then had a devil of a time fighting off a swarm of excited co-workers who wanted to move to the STG with him. When the 21-year-old Lewis engineer Glynn Lunney heard about what the STG was doing, he thought, “Gee, that looks like it would be a hell of a lot of fun—let’s go do that!” Carl Huss and Ted Scopinski worked at the same desk in the Aircraft Loads Laboratory in Langley’s West Area. The two engineers recall one day in late 1958, after they had heard so much about the STG from former co-worker John P. Mayer: “[We] looked at each other and asked why we didn’t transfer over to the Space Task Group. So we did.”¹⁹

Spaceflight Revolution

Wild enthusiasm might have been confined to the young and inexperienced, but strong passion for Project Mercury was not. Donlan looked upon the manned satellite project “as a pioneering effort of a type that comes along only about once in a half century.” To him, the project offered a moment in history that would be “similar to aviation when Lindbergh flew the ocean.” He never doubted that he should join the STG: “I had to participate in what I instinctively felt would be a breathtaking operation, and I decided to do so without much thought as to the long-range possibilities.”²⁰ In the end, his time with the STG (November 1958–May 1961) did not hurt his career. When he resigned his position as the STG’s number two man, he rejoined the Langley operation as Floyd Thompson’s associate director.

The rest of Langley’s senior staff was not as easily impressed by the man-in-space program. With the exception of the two men from the director’s office, only one member of Langley’s senior staff joined the STG: Charles Zimmerman, assistant chief of the Stability Research Division. Zimmerman was not keen about the assignment. “It was a traumatic experience as far as I was concerned,” Zimmerman remembers. After spending a hectic summer in Washington with Gilruth’s planning group, he said, “The hell with this.” He got in touch with Henry Reid and told him that he wanted to come back to Langley. After taking a week off to vacation in Canada, he returned to Langley Field. “I got back home on Friday and was going to go to work on Monday,” Zimmerman recalls, but that Friday night a colleague came to break the news that Zimmerman had been assigned to the Mercury group. “So, there I was in it again.”²¹ Once more, Zimmerman had to put aside his precious airplane work.*

At 51, Zimmerman was the old man of the STG; several of the others were young enough to be his children. He had started his career at NACA Langley in 1929, only two years after Lindbergh’s transatlantic flight, and like many NACA researchers of his generation, he was not comfortable with the idea of moving away from aeronautics into the management of a large manned space program. For Zimmerman and most other senior Langley staff members, the excitement of the program was not enough to compensate for the headaches and perhaps even the career risks associated with moving outside the comfortable confines of aeronautical research. Perhaps the country’s interest in manned spaceflight was just a passing fancy, some of the older men thought. Project Mercury had been authorized, but nothing else up to this point had been. Throwing in with the lot of the “space cadets” meant accepting a great many technological, political, institutional, and personal career unknowns.† If the initial series of Mercury launches came off successfully, the manned space program would probably continue

* Zimmerman, famous for the XF5U “flying flapjack,” which he designed for Vought during the 1940s, had been busy for a number of years trying to make the conventional airplane into a VTOL machine.

† Space cadet is an expression of derision taken from a popular American television show of the 1950s.

in some form, and it might even be expanded, but late in 1958 no one could be any more sure about that than they could be about the outcome of the upcoming 1960 presidential election, on which so much about the course of the U.S. space program would ultimately depend.

With the exception of the graying triumvirate of Zimmerman, Gilruth, and Donlan, the entirety of Langley's senior management stayed where they were in the organization and continued what they had been doing. At least a few of the senior staff also privately advised their juniors to do the same. One member of the STG remembers that his division chief tried to persuade him not to accept the transfer to the STG. "You don't want to ruin your career," the division chief told him. "There's nothing going to come of this, and you're going to be hurt by it." Manned spaceflight, he warned, was just a fad.²²

Many veteran employees felt that "it just wasn't the Langley way" to implement big projects like Mercury. The laboratory had flourished for more than 40 years by doing research, not by implementing things.²³ It had remained strong and autonomous by developing its own competencies and by doing nearly everything that involved research in-house, but Project Mercury was to be based on considerable work that was contracted out to industry. The people responsible for the contract work would have to cover many new fronts: they had to prepare space capsule specifications; evaluate contractor proposals, then monitor the awarded contracts; procure Redstone rockets from the army and Atlas rockets from the air force; arrange for launch services; coordinate recovery operations; and so on. Skeptics feared that members of the STG would be so caught up in the urgency of managing contract work and in refereeing contractor haggling sessions (much to his chagrin, Zimmerman became chief of the STG's Engineering and Contract Administration Division) that they would not be conducting much research, if any. Becoming bureaucrats rather than staying technical personnel was a fate too horrible to ponder. To this day, Bob Gilruth holds his forehead when remembering how Langley colleagues would approach him during the heyday of Mercury not to inquire whether he had had any good ideas recently but rather to ask snidely, "Well, have you let any good contracts today?"²⁴ His old NACA associates might have envied Gilruth the publicity he was receiving, but they did not envy him his work.

Gilruth's senior colleagues who did not want to join the STG did follow Floyd Thompson's example of helpfulness and energetically supported NASA's manned satellite project through traditional research avenues. "At the outset of the program, Langley threw all of its resources behind the infant STG," Thompson reflected in 1970, "providing technical and administrative support informally as required, just as though the STG was a part of Langley and not a separate organization."²⁵ Besides providing extensive support for the development and implementation of the Big Joe and Little Joe projects, dozens of center personnel conducted experimental studies aimed at evaluating the performance of the Mercury spacecraft at

Spaceflight Revolution

launch, in space, during reentry, and during its ocean recovery. Dozens of others became involved in engineering, shop, instrumentation, and logistic support for much of the STG's own in-house testing.

For example, in 1959 a battery of wind-tunnel tests using scale models of the Mercury capsule and capsule-booster combinations had helped to provide needed data about lift, drag, static stability, trajectories, heat transfer, heat-shield pressures, and afterbody pressures; only after hundreds of these tests would the shape and appearance of the Mercury capsule be refined and finalized. At Wallops, engineers had mounted small models of the Mercury capsule on the tips of research rockets, launched them through the complete speed range predicted for the proposed spaceshot, and collected thousands of data points about the capsule's structural integrity, tumbling characteristics, and reentry dynamics. With the military's assistance, Langley researchers also tested the reliability of the capsule parachute system and determined the optimum altitude at which to deploy the drogue chute. From a C-130 Hercules transport that had been loaned to NASA by the U.S. Air Force Tactical Air Command at Langley Field, full-scale, one-ton models of the Mercury capsule prepared at Langley were dropped from an altitude of 10,000 feet into the Atlantic Ocean off Wallops Island. Motion pictures from cameras in T-33 chase jets were used to make a detailed engineering study of the capsule's motions during descent and the impact forces on it when smacking into the sea. Langley personnel also conducted other impact studies by dropping small models of the space capsule at 30 feet per second (21.6 miles per hour) into the Hydrodynamics Division's Water Tank No. 1.²⁶

While the numerous aerodynamic, structural, materials, and component tests were going on at the center, Langley representatives were arranging a schedule for wind-tunnel tests at the air force's Arnold Engineering Development Center in Tullahoma, Tennessee, and a team of non-STG staff members was being assembled to travel around the world to plan Project Mercury's global tracking network, the responsibility for which NASA headquarters had just assigned to the research center at the STG's request in February 1959. In addition to this colossal effort, Langley engineers and technicians were developing the simulators and spaceflight procedure trainers for the Mercury astronauts who had just been entrusted to the STG. By opening day of the NASA inspection in October 1959, Langley had sent six months' worth of weekly reports to NASA headquarters about the great volume of work being done in support of Mercury. Of the laboratory's 1150 employees, 119 of them (about 10 percent) had been working full-time on the project in recent months.

In the year following the STG's establishment, between October 1958 and October 1959, some 250 people were added to the original STG; more than half came from Langley's staff. Many of the key people who moved from Langley to the STG brought with them important experience in flight-test research. Floyd Thompson wanted to give Gilruth a strong

Carrying Out the Task



L-59-336



L-59-3397

The Mercury spacecraft and booster rockets underwent extensive testing in Langley wind tunnels. The full-size capsule is mounted in the Full-Scale Tunnel (top). A one-sixth scale model of the Mercury capsule is tested in Langley's 7 × 10-Foot High-Speed Tunnel to determine the effect of escape system power on the capsule's stability (bottom).

Spaceflight Revolution



L-59-4335

The Redstone booster carrying the spacecraft is mounted for testing in Langley's Unitary Plan Wind Tunnel.

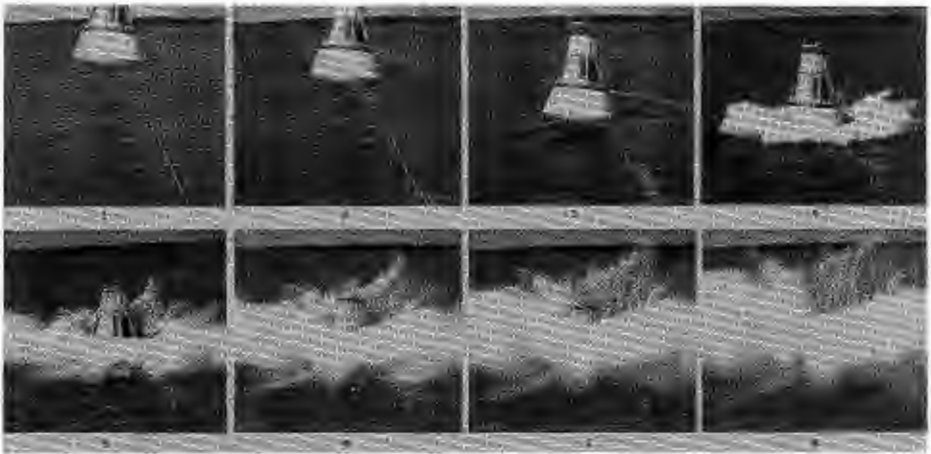

L-60-76

In impact studies conducted in the Back River behind Langley's East Area, the astronauts practiced the dangerous maneuver of getting out of the space capsule as it floated in water.

cohort that understood “flying men”—pilots, that is—not just the flying of pilotless models. “Tommy wanted to make sure that there were enough flight guys involved in this venture,” Donlan remembers.²⁷ Fortuitously, NASA headquarters recently had made a decision to limit Langley’s flying and had transferred most of its flight research activities to the NASA center at Edwards AFB. This decision disappointed Langley researchers and made them ready to jump at the chance to get involved with the manned space program. Consequently, several top-notch Langley flight researchers became part of the STG. Along with Gilruth (also a former NACA flight research engineer), Walter C. Williams, former director of the NACA Flight Research Center in California, and Christopher C. Kraft, Jr., and Charles W. Mathews, both standouts in Langley’s Flight Research Division, became the heart of the Project Mercury flight operations team.

The Tracking Range

Of all the Langley efforts in support of Project Mercury, by far the biggest, the most difficult to carry out logistically, and the most adventuresome was the Mercury tracking range project. NASA flight operations officers and aeromedical specialists wanted to have almost constant radio contact with the Mercury astronauts. To maintain communication with the spacecraft as it circled the earth, NASA had to create a worldwide communications and tracking network.

In the early days of Project Mercury, NASA really did not know what sort of tracking network was needed to monitor its spacecraft. Those frontier days of the manned space program before the operation, let alone the very idea, of a “mission control” center are hard to remember. Over the last three decades, the public has grown familiar with the drama and the emotionally charged “electricity” of the control center amphitheater. This amphitheater, with its tidy rows of communications consoles, computerized workstations, and its front wall covered with a large electronic map of the world, became thought of as the brain and nerve center of a NASA spaceflight mission. Here, in what one NASA astronaut has called a “temple of technology,” worked the middle-aged men in white shirts and dark neckties—the flight controllers who wore the headphones and the worried looks as they talked to the astronauts in the spacecraft and made the split-second, life-or-death decisions about whether to “abort” or “go for orbit.”²⁸

This stage for the high drama of “space theater” did not exist prior to Project Mercury. The flight tests of the most experimental, high-speed airplane had not required the development of a ground-control facility as sophisticated as mission control. Even at a pioneering place like Edwards AFB, the role of the flight experts on the ground had involved little more than “getting the airplane into the best possible mechanical condition, spelling out the day’s test objectives for the pilot, and retrieving data from

Spaceflight Revolution

the instrumentation after the plane landed.”²⁹ During the flight itself, flight operations people talked to the pilot in moderation; for the most part, they quelled their curiosity, shaded their eyes, strained anxiously to follow the flashing metal arrow through the sky, and left the pilot to his own devices.

At first, the STG envisioned little more than this rather passive mode of flight control for the Mercury spacecraft: checking it out before launch, maintaining a voice link with the astronaut to see how things were going, but letting the astronaut and the automatic in-flight systems do the rest. After reflecting seriously on the immense task before them, that vision changed. “I don’t know how to describe it exactly,” explains Glynn Lunney of the original STG, “but we began to realize that, ‘Hey, we’re going to fly this thing around the world!’” In that instant of stark realization came the feeling that certain critical decisions about a spaceflight—such as whether to abort immediately after launch, to use the escape rocket, or to blow up a maverick rocket before it dug a big hole into downtown Cocoa Beach—could be, and should be, controlled from the ground. Out of this conviction came the concept of a ground room with not just a person talking to the astronaut, but many people analyzing tracking and telemetry data on the status of the launch vehicle and the spacecraft.³⁰ Already by the time of the first NASA inspection in October 1959, the STG was calling this room the Mercury “Control Center” and was moving rapidly to have one built at Cape Canaveral.

As the vague and open-ended possibilities of Mercury flight operations and mission control became more clearly defined, the STG decided that to be out of communication with the astronauts during their spaceflights for very long would be neither wise nor safe. The STG’s flight operations people and more conservative aeromedical specialists argued over the maximum amount of time they could be out of contact with the astronauts. The physicians were “horrified at the casualness” of one suggestion that in-flight communications with the astronauts could be handled like commercial air traffic control, with the pilot only reporting to the ground every 15 to 30 minutes.³¹ The doctors, intent on continuous and complete monitoring of the astronaut’s vital physiological and mental responses to the unknown demands of spaceflight, did not like the idea of gaps in communication lasting for any appreciable length of time. Without the resolution of this internal debate, engineers could not establish design parameters necessary for proceeding with the global tracking network. In the end, the STG decided that a tracking network was needed in which gaps in communication lasted no more than 10 minutes.³²

Fathoming the immensity of what had to be done to establish this network took time. Initially some naive Langley engineers believed that whatever tracking stations were needed by the Mercury team to provide “real-time” tracking data could be provided simply by mounting radar sets on rented air force trucks that could be stationed at sites around the world. But after giving the matter careful thought, the communications experts

“began to realize that it wasn’t good enough to have isolated radar sets: the people back at the Control Center needed a network of linked stations, capable of receiving, processing, and reacting to a variety of voice, radar, and telemetry data.”³³

Thus began a Promethean task because 1960 was a different technological age—especially in terms of communications. An instantaneous telephone call around the world was not yet possible. The only long-range communication, from continent to continent, was by undersea telegraph cable, and most of these cables had been laid at the turn of the century by the British. That is not to say a remarkable telecommunications network did not exist. Over the years the British, among others, had built up an amazing global system involving tens of thousands of miles of submarine cables as well as vast distances covered by wireless communications, but the day of instantaneous electronic communication around the world had not yet arrived. Its arrival depended largely on the launch of communications satellites like Telstar, which the infant space programs at that time were making possible. For NASA staff to have the type of communications necessary for control of the Mercury spacecraft and for assistance to the astronauts, they had to build their own global system.

Creating this global network was a job that NASA Goddard Research Center could not do from its temporary quarters at Anacostia. Also, Goddard people were still responsible for the Minitrack Network that had been set up for the Project Vanguard satellite, so they were busy tracking the unmanned satellites that were then being launched. This existing system was not suitable for tracking the orbit of the Mercury spacecraft because the system had been laid out north-to-south (along the 75th meridian), whereas STG studies had concluded that the best orbital path of the Mercury spacecraft would be west-to-east along the equator. Minitrack, even in combination with other existing commercial, scientific, and military communications networks, had far too many “bare spots” to provide the comprehensive global coverage required for Mercury.³⁴

The STG was unable to take on this job because its manpower was already stretched to the limit; STG staff could not bear the additional load of setting up an ambitious new tracking and communications net that had to reach completely around the world. “There was just no way [for the STG] to build the spacecraft as well as the ground tracking network,” says William J. Boyer, the fellow from Langley’s IRD whose transfer to the original STG had been short-circuited by his division chief in November 1958. Boyer, who became one of the most active members of the Langley team that built the Mercury tracking range, remembers that Howard Kyle, the IRD engineer who was named to replace him on the STG, was the first to come to this conclusion. Kyle, without any trouble, persuaded STG’s Chuck Mathews of the impossibility; Mathews in turn convinced Bob Gilruth; and Gilruth asked Floyd Thompson whether Langley, with NASA headquarters’ approval, could take on this additional heavy responsibility.³⁵

Spaceflight Revolution

Once again, Thompson wanted to do everything he could to make Project Mercury a success. So in February 1959, he called in his assistant director, Hartley Soulé, and they put together an ad hoc team that came to be known as TAGIU (pronounced “Taggy-you”), which stood for the Tracking and Ground Instrumentation Unit. Heading the temporary unit was Soulé himself, who was deemed the tracking range project director. G. Barry Graves, Jr., the head of IRD’s Pilotless Aircraft Research Instrumentation Branch, was to handle the detailed management of the tracking network project from a special TAGIU office, and Paul H. Vavra, Graves’s colleague in the IRD branch, was to assist. The unit was placed within IRD on an organizational chart. No one really knew how much work faced them: members of TAGIU were told initially that their work would be part-time and add only slightly to their regular duties. But as Vavra notes, “a few weeks later we were in the space program night and day and never thought about our other jobs.”³⁶ As with everything else concerning Project Mercury, TAGIU progressed rapidly. On 30 July 1959, NASA awarded the contract for the creation of an integrated spacecraft tracking and ground instrumentation system to Western Electric Company and its four major subcontractors: Bell Telephone Laboratories of Whippany, New Jersey, for system engineering, engineering consultations, and command and control displays; the Bendix Corporation of Los Angeles and Towson, Maryland, for radar installation, ground-to-air communications, telemetry, and site display equipment; Burns and Roe of Long Island for site preparation, site facilities, construction, and logistic support; and International Business Machines Corporation of New York for computer programming, simulation displays, and computers.³⁷ Monitoring the contract involved the expenditure of nearly \$80 million and extensive negotiation with other federal agencies, private industry, and representatives of several foreign countries. However, in June 1961, less than two years after awarding the contract, Langley looked on with pride as the power for the around-the-world-in-an-instant communications system was turned on for the first time.

Working on the global tracking range took Langley personnel farther away from the comfortable confines of their wind tunnels than any other aerospace project ever had before, or has since. In the two-year period between the awarding of the contract and the initiation of the tracking operations, a team of engineers and technicians from NASA Langley traveled tens of thousands of miles to some of the most remote places on earth. They went to oversee the building of an ambitious network that when completed stretched from the new Mercury Control Center at Cape Canaveral to 18 relay stations spanning three continents, seven islands, and two ocean-bound radar picket ships. Along its way around the world, the network utilized land lines, undersea cables and radio circuits, special computer programs and digital data conversion and processing equipment, as well as other special communications equipment installed at commercial switching stations in both the Eastern and Western hemispheres. The network involved range



George Barry Graves, Jr., head of the Pilotless Aircraft Research Instrumentation Branch of Langley's IRD, handled the detailed management of the Mercury tracking network from a special office within the ad hoc TAGIU.

L-61-659

stations in such faraway and inaccessible places as the south side of the Grand Canary Island, 120 miles west of the African coast; Kano, Nigeria, in a farming area about 700 rail-miles inland; Zanzibar, an island 12 miles off the African coast in the Indian Ocean; a place called Woomera, amid the opal mines in the middle of the Australian outback; and Canton Island, a small atoll about halfway between Hawaii and Australia.

"It was quite mind-boggling to realize that you're living in Hampton, Virginia, and you were getting tickets to change planes in the Belgian Congo to go to Kenya and from there on to Zanzibar," exclaims Bill Boyer. Boyer traveled with Barry Graves's small "management team," which negotiated with foreign governments and picked the tentative sites for the Mercury tracking stations. In Madrid his team sat for four weeks waiting for the Spanish government to grant permission to go to the Canary Islands. On their way through central Africa, in the Belgian Congo, group members moved cautiously past threatening gun-toting rebels who were fighting against European colonial rule. "We would pick the tentative sites based on the technical criteria established by the Space Task Group," Boyer states, "and then we'd go around to the telecommunications people in those foreign countries to get as much advice and assistance from them as we could." The TAGIU team looked into the logistics of particular sites: Where would NASA people eat? Where would they sleep? How would they be supplied? What were the capabilities of the local construction companies? After addressing these questions, the management team would move on, and a

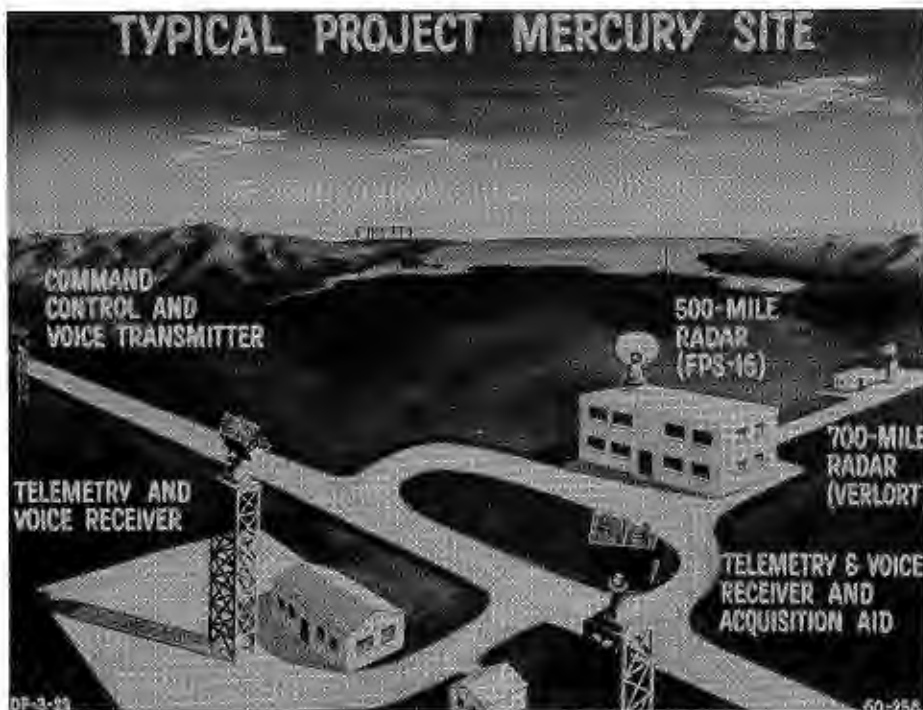

L-61-5740

A layout of a typical Project Mercury tracking site as conceptualized by Graves's outfit in 1961.

“technical team” would move into the recommended site. This larger, follow-on team would then conduct a detailed study to determine whether the site met technical criteria: could NASA construct the buildings it needed, and were the materials easily available? The technical team would then make a final recommendation about the proposed site.³⁸

As with so many other rushed and complicated operations of the early manned space program, much about the multimillion-dollar Mercury tracking network could have gone wrong. Instead, it worked like a charm, tracking the spacecraft with a high degree of accuracy. In the words of Edmond C. Buckley, the former IRD head at Langley who by the time of the first Mercury orbital flight by John Glenn was the director of tracking and data acquisition at NASA headquarters, the network “worked better than it could have in the most optimistic dreams.”³⁹ For example, as the system tracked the spacecraft from the Bermuda station on, NASA found that the “residuals,” that is, the comparison of the computed predicted path and the actual path as determined by each location, differed in most cases by less than 1000

feet and in some cases by less than 100 feet. These figures compared favorably with the ability of tracking systems of that day to report the location of naval ships crossing the oceans.

The creation of this unprecedented and highly successful worldwide ground instrumentation and tracking network required the services of many members of the Langley staff beyond those formally part of TAGIU. Three Langley organizations (as well as several outfits at Wallops Island) played major roles in establishing the network: IRD, which helped to guide the design of the electronic systems; the Engineering Service Division, which assisted in the selection of sites and the coordination and monitoring of the station construction; and the Procurement Division, which negotiated the huge contract and maintained constant liaison with the prime contractor, Western Electric, and its associates. Thanks to this extensive effort, NASA was able to have the kind of direct and comprehensive contact with the astronauts and their spacecraft that the flight operations and medical experts believed was necessary. As Edmond Buckley remarked, in a masterpiece of understatement, Langley "can take a well-deserved bow."⁴⁰

Shouldering the Burden

Nothing was more important to the stated objectives of the American space program by the early 1960s than Project Mercury, but supporting the program was still a burden on Langley Research Center. Gilruth admits that the days of a rapidly expanding Mercury program must have been "particularly difficult for Langley" because Gilruth's need for good people was such that he "could not help but continue to recruit" from the center. Faced with Gilruth's personnel demands, Thompson bargained with him. "Okay, Bob. I don't mind letting you have as many good people from Langley as you need . . . but for every one that you want to take . . . you must also take one that I want you to take." From that day, whenever Gilruth recruited a person for the STG, he also took a person that Thompson was, for one reason or another, eager to transfer.⁴¹

Thompson became the center director in May 1960, and Henry Reid moved on to become his titular senior adviser. Aware that certain Langley staff members were not productive in their present positions, the crafty Thompson wanted to make room in his organization for some new blood. Langley had found ways to make room in the past, notably in the 1940s when several wagonloads of its people had moved west to colonize the newly created NACA centers in Ohio and California. The founding of new laboratories such as Ames and Lewis, and now the STG, enabled the center director to transfer out restless souls and nonproductive old-timers along with the people who were crucial to the success of the new operation. These transfers allowed for the influx of fresh and dynamic young people that Langley continually needed to remain a productive laboratory.

Spaceflight Revolution

While Langley's support for Project Mercury continued to expand, so too did the size and experience of the STG. With Langley's help, the STG's capacity for handling its own technical and administrative affairs increased dramatically. By the time Thompson officially became the director, he and his senior staff recognized that Langley's ad hoc parental role in the Mercury program needed further definition. According to Thompson, the time had come "to replace the informal free-wheeling and somewhat chaotic working arrangements with orderly procedures." A formalizing of relations was needed to "clearly identify the respective responsibilities of the two organizations" and to establish more distinct channels for authorizing and conducting business. Otherwise, too many more of Langley's own precious capabilities would be carved off for the STG.⁴²

But Thompson's thoughts about Langley's proper relationship to the STG were ambivalent. On the one hand, a voice within Thompson told him to follow the advice that Hugh Dryden had been giving him about Project Mercury: "Support it, but don't let it eat you up." By that Dryden meant that the director of a research laboratory should not neglect his basic research programs because of the center's appetite for any one big project, however delectable it might seem.* As soon as possible, Dryden warned, the STG needed to become part of a laboratory devoted just to spaceflight development. Dryden knew that in a technical environment where a "research function" and a "development function" tried to coexist, the development function would always win out (as it would later do when Langley managed the Viking project). If Langley kept the STG, Dryden worried, the center would inevitably lose many of its most capable people to development. Without its expertise in research, NASA would turn into a shadow of its former self and something less than what the country needed it to be.

Moreover, Thompson was plagued by some troubling questions: What happens when "the development" reaches completion? How are the "development people" brought back effectively into the general research program, or do these people just continue to look for things to develop? The only way to truly ensure the priority of the center's research function was to move the STG away from Langley completely, but by the early 1960s so much of NASA Langley's identity was tied up with the success of Project Mercury and the publicity glow surrounding its astronauts that Thompson and others at Langley were not at all sure they *wanted* to lose the STG to some other facility. The STG was so important to the national mission, so many resources were being devoted to it, and the American public was becoming so fascinated with astronauts and the prospect of manned spaceflight, that even the most clearheaded researchers at Langley were turning a little misty over the center's involvement in Project Mercury. At Langley the number

* Although Hugh Dryden supported Project Mercury, he was in truth no great fan of the emphasis NASA placed on it.

of “envious people who didn’t want to leave their own jobs but who liked to bask in the [STG’s] limelight” was growing.⁴³ Mercury was a mushrooming project that was suddenly making national, even international, news. The local press was sending reporters out regularly to the center—something that had never happened before. The attention was a lot to lose.

Thompson was less alarmed by the risks of supporting the STG and Project Mercury than Dryden, although he claims to have understood them well. Thompson was willing to gamble that the STG would help Langley more than harm it. In the long run, Thompson argued, “the broader demands imposed by a space program added to an existing aeronautics program” would make the research role more important to the country than it had ever been before. To carry out the space program while continuing to stimulate the aircraft industry and support commercial and military aviation required more fundamental research, not less.⁴⁴

A voice inside Thompson told him that the STG should become an official part of Langley; into the early 1960s, this voice of aggrandizement, not Dryden’s of caution, dominated much of Thompson’s thinking and some of his behind-the-scenes activities and management decisions pertaining to Project Mercury. “He wanted to combine the STG with Langley and have Langley manage it,” recalls Laurence K. Loftin, Jr., one of Thompson’s closest associates from the time. “He wanted to run the whole damn thing.”⁴⁵

However, in a research culture with deep NACA roots like Langley’s, not everyone felt that supporting the STG was an acceptable risk. These feelings were reflected in such mundane matters as board hearings about promotions. Originally the STG went through the regular Langley board for promotions, but some STG members felt “they didn’t get a fair deal” that way. For example, candidates for promotions who had done jobs such as the preparation of Mercury training manuals were “considered unfavorably” by Langley people who felt that the production of a traditional research report was a much more important achievement. Feelings about this “unfair treatment” eventually grew so strong that the STG decided to create its own promotions board to sidestep those at Langley who felt that writing training manuals amounted to “clambake work” and was not “worth that kind of money.”⁴⁶

Funding was at the root of some of the senior staff’s concerns. They worried that the STG might absorb so much of the center’s research capability that NASA headquarters would reduce its support for Langley’s independent research function. The tail would start wagging the dog. Most members of the STG were too busy, ambitious, or imprudent to discourage this notion. Some STG members believed that they would continue conducting research while proceeding with Project Mercury. If that happened, some at Langley worried, NASA’s and the country’s support for independently funded research at the center might be badly, and perhaps

Spaceflight Revolution

even fatally, compromised. Langley might turn into a place that handled big projects while remaining no more than semiactive in research.⁴⁷

Only very gradually and reluctantly did Langley management and the conflicted Floyd Thompson come to feel that something had to be done to cut the apron strings that connected Langley to the STG. Certain productive steps were taken by NASA headquarters in 1959 and 1960 to strengthen the STG's own organization and management and reduce its dependence on Langley for administrative and technical support.⁴⁸

One of the steps taken to distinguish the STG operation from that of the larger research center simply involved office space and physical facilities. Pressed for space, Langley had assigned the STG initially to the second floor of the Unitary Plan Wind Tunnel building in the West Area. But before long, Langley relocated Gilruth and his staff to facilities in the East Area. Two factors behind the move were the need to expand and the desire to find a cluster of offices where the growing STG could work as a consolidated team, but a third seems to have been the prejudice of the Langley senior staff against locating research and development functions so close together within the confines of the same center.

In the East Area, the STG went to work inside two of the oldest buildings at the center; they had been constructed nearly 40 years earlier, before the laboratory's formal opening in 1920. Building 104 (later renumbered NASA no. 586) was the old Technical Services building; to make room for the STG, some of Langley's systems and equipment engineering people had to vacate their dusty premises. Building 58 (later renumbered NASA no. 587) had served as Langley's main office from 1920 until the new headquarters building opened in the West Area right after World War II; in the center telephone directory, this once important building on Dodd Boulevard, the former home of Langley's engineer-in-charge, was still referred to as the Administration building. In 1959 the sturdy two-story, red-brick structure housed the East Area's cafeteria, a group of stenographers, the center's editorial division, as well as most of the personnel, employment, and insurance offices. To accommodate members of the STG, some but not all of these office operations were moved to buildings in the West Area.

The rapidly expanding STG eventually took over most of NASA's buildings in the East Area, as well as several adjacent air force facilities. But the STG remained hungry for space. Langley management had to release a few buildings in the West Area for STG use. For instance, Building 1244 became a staging area where technicians refurbished the boilerplate capsules that were used for drop tests in the nearby Back River, and Building 1232 was turned into an STG fabrication shop where prototype capsules were inspected and assembled.

Members of the STG did not complain much about the patchwork nature of these quarters because the group was housed at Langley only temporarily, pending transfer to a permanent base of operation. Abe Silverstein, the head of the Office of Space Flight Development, planned to move the STG

to Goddard when the facility for the new spaceflight center in Greenbelt, Maryland, was completed. Although located at Langley, the STG had been reporting directly to Silverstein's office in Washington, but this arrangement, like housing the group at Langley, was a temporary expedient until a more permanent arrangement could be established.⁴⁹

The management logic behind the transfer of the STG into the Goddard organization came from Silverstein: a focused little organization like the STG might be capable of running the technical part of its operation, but in terms of handling budgetary matters, looking after swelling fiscal and procurement responsibilities, and supplying material and housekeeping support, the STG needed all the help it could get. NASA did not have the resources to build a complete organization around a solitary task force carrying out a single project, no matter how important the project. It made more sense to place the task force inside an existing organization already having a complete range of capabilities—but not as overburdened with responsibilities as Langley.

Most members of the STG disliked Silverstein's plan. They did not want to move to a suburb of the nation's congested capital city, and they were a little bitter over what they viewed as a lack of appreciation for the magnitude of their work. The manned spaceflight program would be only one of several projects at the new Goddard center. If Gilruth and the rest of his STG could have had their way, they would have preferred to stay at Langley and continue the close relationship with the center that both sides had found workable from late 1958 on. In spite of the heavy drain on his center's manpower and facilities and the justifiable fears about what such a big space project might do to divert and distort essential research capability strengths, Floyd Thompson ultimately would have preferred to keep the entire manned space program at Langley. Such were the personal and institutional temptations that came with the spaceflight revolution and its "big technology."

The STG, however, was made formally a part of Goddard on 1 May 1959, which was Goddard's official opening day. Although still housed at Langley and separated from the new spaceflight center by more than 100 miles of Tidewater Virginia, the STG became the Manned Spacecraft Division of Goddard, with Gilruth serving as the new center's assistant director for manned satellites while remaining the director of Project Mercury.

In the beginning, everyone had thought that Bob Gilruth would be the director of Goddard and that the new space center would be not only the place for manned spaceflight but also for all of NASA's space science activity. As Charles Donlan remembers, "When Dr. Dryden gave Gilruth his first title, it wasn't 'Director of Project Mercury,' it was 'Assistant Director of Goddard.'" The thought was that Gilruth would be the director. In fact, in the fall of 1958, Gilruth and Donlan, figuring they were going to be the director and deputy director of this new Goddard center, "went up and looked over the place and what-not." Donlan recalls, "We spent some

Spaceflight Revolution

time thinking about how we would organize it.” In the meantime, however, Project Mercury was bubbling along at a very fast rate. “Silverstein was anxious to get Goddard moving, and he knew that Gilruth was going to be tied up with Mercury,” Donlan explains. So Silverstein brought in Harry Goett, a friend he used to work with in Langley’s Full-Scale Tunnel in the old days before Goett moved to the Ames laboratory in the early 1940s and before he, Silverstein, moved to Lewis. “This upset Gilruth very much,” Donlan recalls, “but nevertheless he decided he’d rather work on the manned program than spend his time organizing a new center.”⁵⁰

In truth, the STG always acted quite independently of Goddard’s control. Harry Goett, the figurehead director of the STG’s operation, and some of his associates visited Langley almost weekly and were always received “politely but noncommittally.” Goett told Donlan and others flatly that “he knew what the situation was”: Goddard’s control over the STG was *pro forma* and that most STG members, from Gilruth on down, felt some contempt for the contrived relationship. Fortunately, the awkward “paper” arrangement did not last long enough for hard feelings to develop on either side.⁵¹

By the time of President Kennedy’s May 1961 commitment to landing astronauts on the moon, everybody in NASA realized that the manned space program was never going to be just a division of some other center. Silverstein and others at NASA headquarters finally decided to break off the STG as a completely separate entity, away not only from Goddard but also from Langley.

The fate of the STG, however, ultimately came to rest in the hands of powerful people beyond the control of Langley or the STG—or even NASA headquarters. Influential people representing vested political and economic interests were maneuvering behind the scenes to build a manned spacecraft center in Texas. The principal players behind the Texas plan were Vice-President Lyndon B. Johnson, the nation’s number two man in the executive office but number one space enthusiast; Representative Olin E. Teague of College Station, Texas, the third-ranking member of the House Space Committee; and Albert H. Thomas, chairman of the House Independent Offices Appropriations Committee, a powerful link in the legislative chain that reviewed NASA’s annual budget requests.⁵² In September 1961, after months of unsettling rumors (often denied by NASA) that the STG would be moving to a large and expensive new facility in Texas, and despite outspoken criticism of the alleged backstage chicanery expressed by the outraged politicians and newspapers serving the equally vested interests of the Commonwealth of Virginia, NASA announced that the STG would in fact be moving from Langley to a 1620-acre site at Clear Lake, some 25 miles south of Houston, which just so happened to be in Albert Thomas’s own, hurricane-torn, congressional district.⁵³

“Now what’s behind this need for relocation?” asked one editorial in the *Newport News Daily Press*. And the questions kept coming:

Carrying Out the Task

What is needed that we don't have, or can't get, right here where the Space Task Group was conceived and developed? . . . What is wrong with research facilities presently located in the Langley Research Center area? Some of this 'back 40' could be conditioned for space probe progress and closely related to the existing complex of laboratories, facilities, and manpower.

The simple one-word answer, the local media sourly reported, was "politics." This angered area residents. In their minds, the activities of the STG and Langley Research Center were "interwoven." To tear them apart was not only "a terrible waste of time and money" but was also tantamount to kidnapping a brainchild.⁵⁴

Many of the STG members were unhappy as well. "I was so upset about going to Texas," one STG engineer still remembers with indignation, "I wouldn't even let them send me the free subscription to their goddanged newspaper." But, once the decision was made, nothing could be done about it short of leaving the manned space program. A native and lifelong resident of Hampton, Caldwell Johnson, who had just built a beautiful new waterfront home, sums up the predicament: "I'd eat my heart out if I stayed here and let all these other guys come to Houston and do this. I would've kicked myself fifty thousand times."⁵⁵ In the frenetic period during late 1961 and early 1962 when thousands of preparations for the first Mercury orbital flight still had to be made, Caldwell and 700 other engineers and their families packed their belongings and drove the 1000-plus miles to East Texas.

Although no one at Langley was happy to see the STG go, many sighed with relief when the group finally left. "It would have been a great mistake to have had the STG stay at Langley," argues Charles Donlan in retrospect. According to Donlan, who by the time of the move to Texas was back at Langley as Floyd Thompson's associate director, once the decision was made that the STG would go someplace else, Thompson and everybody else felt that "it was for the best, because if it had stayed it would have overwhelmed the center."⁵⁶

The move helped Langley almost immediately. As a compensation for the loss of the STG, NASA approved a \$60-million expansion of Langley and authorized the center to hire several hundred new employees to replace the departing STG members. Hugh Dryden, who had been looking out for the interests of the center at NASA headquarters, was in part responsible for these boons. "That was the best thing that could have happened," says Donlan about the authorization to hire, because one of the most important resources for creative thinking at a research laboratory is a supply of young minds. "We got the cream of the crop of many of the best kids coming out of the universities," Donlan remembers. Thanks to the STG's departure, Langley received a healthy infusion of the "fresh blood" Thompson wanted, and instead of it all flowing into space project work, most of it was channeled into the general research areas.⁵⁷ It was a development that, on balance,

Spaceflight Revolution

pleased Langley's senior management and made them less regretful over the STG's leaving.

The experience of having had the STG at Langley also helped to clarify management's thinking about the proper relationship between projects and fundamental research and helped a few to understand better that *all* projects eventually reach a dead end. Donlan remembers the policy started after the STG moved away from Langley: "Whenever a new guy came in, we never put him in a project. [We would] put him in one of the research divisions and let him work there for a few years. If a researcher then wanted to try something else, fine, stick him in a project."⁵⁸

A management philosophy that called for a mix of experience was healthy for the overall NASA operation, especially because it enhanced the in-house capability of the field centers. People assigned to projects did not have to do research work, meaning that they could devote their time to the job at hand. But the breadth and depth of problem-solving experience gained during the required period in major research divisions almost always immeasurably helped scientists and engineers if and when they did become involved in the management of a project.

Although the new management philosophy solved some problems, the tension and ambivalence created by supporting development work would persist at Langley well beyond Project Mercury. The same tension would be present through the Apollo program, the Viking project, the Space Shuttle program, the space station program, and beyond. Because of Sputnik and the ensuing space race, development projects would always be a part of Langley, and the conflicting feelings surrounding them would never go away. Buried deep inside those feelings was the final and most worrisome irony of all, which Hugh Dryden tried to make Floyd Thompson recognize: *everything* about the space program in the long run could turn out to be ad hoc except *research*. No one from the NACA except the clairvoyant Hugh Dryden anticipated this outcome of the spaceflight revolution, and no NACA veterans would be pleased by it.

The End of the Glamour Days

It took about nine months, until mid-June 1962, for the STG in its entirety to complete the move to the new \$60-million facility south of Houston. For Gilruth and associates this period was busy and difficult. At the same time that they were clearing their desks and packing their files, families, and household belongings for the western trek from Langley, they were also doing the thousands of things that had to be done to make John Glenn's February 1962 Mercury-Atlas 6 flight (America's first manned orbital flight) and Scott Carpenter's May 1962 Mercury-Atlas 7 flight the great successes that they turned out to be.⁵⁹

Thanks to President Kennedy's May 1961 commitment to the lunar landing program, the STG (renamed the Manned Spacecraft Center in November 1961) was also gearing up to meet the demands of what was now being called Project Apollo. Although several ideas for lunar missions had been circulating at Langley and the other NASA centers for some time, NASA did not yet know how to send an astronaut to the moon, how to land him on its surface and return him safely, or how to do all three by the end of the decade as President Kennedy wanted. Many crucial decisions had to be made quickly about the lunar mission mode, and the overworked manned spaceflight specialists of the STG, when they found the time and energy, were asked to help make those decisions.

Project Mercury came to an end in the early summer of 1963, following the successful orbital flights of astronauts Walter A. Schirra (Mercury-Atlas 8) in October 1962 and L. Gordon Cooper (Mercury-Atlas 9) in May 1963. As the project drew to a close, Bob Gilruth wrote a letter to Floyd Thompson, thanking his old friend for all the help that Langley had given the STG over the past four years. "It is fitting that the Manned Spacecraft Center express its sincere appreciation to the Langley Research Center for the invaluable part that the Center has played in our initial manned space flight program," Gilruth's letter stated. "The Manned Spacecraft Center owes much to Langley, since . . . Langley was really its birthplace." Specific contributions that Langley had made to Project Mercury were "too numerous to detail completely" but briefly, they included assistance in the Big Joe program; implementation of the Little Joe program; planning and implementation of the tracking and ground instrumentation system; numerous aerodynamic, structural, materials, and component evaluation and development tests; engineering, shop, instrumentation, and logistic support for much of the STG in-house testing; and administrative support and office space during the period from late 1958 until mid-1962 when the STG completed its move to Houston. In conclusion Gilruth wrote, "As you can see, all elements of the Langley Center provided major assistance to Project Mercury, and we are deeply grateful for this help."⁶⁰

The local public also wanted to express its gratitude. On Saturday morning, 17 March 1962, more than 30,000 shouting and flag-waving residents of the Peninsula lined a 25-mile motorcade route through the cities of Hampton and Newport News. The huge crowds, swelling to 10 and 20 people deep in some places, came to salute the country's seven original astronauts, one of whom, Marine Lt. Col. Glenn, had just made the first American orbital flight into space on 20 February. Area residents wanted to show the people of NASA Langley Research Center just how much they appreciated Langley's effort to launch the first Americans into space.

Frequent cries of "Good work, John," "You're one of us, Gus," and similar encouraging messages to the seven smiling astronauts followed the impressive motorcade throughout its meandering trip from Langley AFB to Darling Memorial Stadium in downtown Hampton. Inside the stadium,

Spaceflight Revolution



In his capacity as the astronauts' public affairs officer, Lt. Col. "Shorty" Powers (sitting in the back seat of the convertible with his wife) introduced the astronauts one by one to the enthusiastic crowd. (Photo by Fred D. Jones.)



Astronaut Walter M. Schirra arrives at Darling Stadium for the rally; seven months later, on 3 October 1962, he would become the fifth American to be launched into space. (Photo by Fred D. Jones.)

Carrying Out the Task



The mayor of Newport News, Va., presents Robert R. Gilruth, head of Project Mercury, with a token of his citizens' esteem (left). Below, wild cheers greet astronaut John Glenn and his wife, Annie. From the outset of the manned space program, "The Marine," Lt. Col. Glenn, had been the public's favorite astronaut. (Photos by Fred D. Jones.)



Spaceflight Revolution

5000 people waited anxiously in brisk 50-degree weather for the arrival of the parade. Beneath the speakers' stand in the middle of the football field, where Manned Spacecraft Center Public Affairs Officer John A. "Shorty" Powers would introduce the astronauts and Governor Albertis S. Harrison would deliver the featured speech in praise of them, the huddled spectators watched in anticipation as a red, white, and blue banner fluttered in the strong breeze; the banner read: "HAMPTON, VA., SPACETOWN U.S.A."

Behind the astronauts in the procession of 40 open convertibles rode Gilruth, Thompson, and several prominent Langley researchers and senior staff members. Like the astronauts, the engineers smiled broadly and waved vigorously to the crowd while receiving lusty cheers from the throng.⁶¹ Helping to launch the astronauts into space had altered, in a fundamental way, the public's perception of who these men were and what they did. Instead of NACA Nuts—those shadowy figures whom the public had mostly ignored—they had become NASA Wizards, the technological magicians who were making the incredible flights of mankind into space a reality.

Things had moved full circle. On a previous Saturday morning three years earlier, NASA Langley for the first time in its history had opened wide its gates and played host to the people of the Hampton area. Now the people of Hampton were returning the favor. For them, the glamour of having the nation's first seven space pilots living and working in their midst had been wonderful. Losing them and the rest of the STG to Texas was a bitter pill to swallow.* Thirty years later, long after changing the name of busy Military Highway to "Mercury Boulevard" and dedicating the bridges of Hampton in honor of the astronauts, area residents still reminisce fondly about "the good old days in Hampton and Newport News" when "those brave astronauts" lived in their neighborhoods, ate in their restaurants, and drove down their streets and across their bridges.⁶²

* A headline of the Newport News *Daily Press*, 24 Sept. 1961, read, "See Here, Suh! What Does Texas Have That Hampton Doesn't?"

4

Change and Continuity

What we should do is retain our competence and contract out our capacity.

—Floyd L. Thompson, director of
Langley Research Center

In the working partnership between universities, industry, and government . . . each of the three has retained its traditional values. . . . I believe that each has become stronger because of the partnership.

—James E. Webb, NASA administrator

Born in 1898, the offspring of another century, Floyd Thompson was 62 years old when he took over officially from Henry J. E. Reid as the Langley director in May 1960. When defending the interests of his beloved Langley, Thompson could definitely play the part of a stubborn old curmudgeon.

He played it particularly well in July 1963 at a press conference called by NASA Administrator James E. Webb, President Kennedy's appointed successor to Keith Glennan. In his office at NASA headquarters, Webb announced the appointment of Earl D. Hilburn, a former vice-president and general manager of the Electronics Division of the Curtiss-Wright Corporation, as a new deputy associate administrator. Webb reported to the assemblage that Hilburn would now be responsible for the general management of all the NASA facilities that were not manned spaceflight centers—in other words, Hilburn would manage Ames, Lewis, Langley, Goddard, Wallops, JPL in Pasadena, and the Flight Research Center at Edwards AFB. After introducing Hilburn, Webb turned to Thompson, who had been invited to Washington just for the occasion, stuck out his chin, and asked Langley's director what he thought of the news. Thompson answered loud enough for everyone to hear, "Well, Langley has been around a long

Spaceflight Revolution

time, and I suspect it will be around a lot longer no matter what you people up here do.”¹

This arrogant reply stemmed from Thompson’s devotion to Langley’s long tradition of independence and freedom from bureaucratic headaches and political machinations in Washington. Why should the director of a research center be overly impressed by the news that another bureaucrat was joining the organization in Washington? Although most NASA personnel in the audience knew Thompson well enough not to be stunned by his comment, they were still surprised that he would make it in Webb’s own office and with reporters present. Neither Webb nor any other NASA officials present would ever forget the incident. For many of them, it was just another instance of a prideful Langley trying to go its own way.

But Thompson’s answer revealed more than just pride; it demonstrated his conviction that some essential continuity at NASA must be sustained amid the rapid changes taking place for the space race. Whatever management changes or reforms NASA headquarters made in the affairs of the research laboratories, Langley would continue to do its job.

The Langley center director was no thoughtless institutional reactionary. Thompson had shown by his nurturing of the STG, if not by his comments to headquarters officials, that he was no foot-dragger when it came to supporting and promoting the space program. Not for a moment would he try to stop the spaceflight revolution from happening at Langley; rather, in his own cautious and pragmatic ways he would advocate, encourage, and even delight in NASA’s ambitious objectives. In the changes in the modus vivendi of the NASA laboratory that were taking place in the early 1960s, Thompson recognized an elevated level of excitement and commitment, a new degree of freedom; and an unprecedented opportunity for building unique capabilities that went beyond the constraints of traditional NACA-style, in-house research activities. After the fever of supporting the space race had passed, Langley, Thompson believed, would emerge not weakened, but strengthened.

Sometime in the early 1960s, Thompson invented a motto to capture what he wanted Langley’s new operational philosophy to be: “We should retain our competence and contract out our capacity.”² By that Thompson meant that a NASA center forfeited none of its own capabilities by sharing some of its work with outsiders. Langley should nurture the industrialization of research and development (R&D), which had been taking place at an increasing rate in America since the end of World War II. Langley would not be losing control over its own destiny by farming out some of its responsibilities to American business and industry while taking on certain duties that went beyond the traditional in-house research function. Instead, Langley would benefit because it would now be able to focus on the genesis of valuable scientific and technological ideas, take its own potential to the limit, and accomplish important tasks that could not be done as well any other way. Moreover, in spreading its wealth to contractors, NASA would not just



L-63-3879

Langley Director Floyd Thompson might have done more to obstruct the spaceflight revolution at Langley if he had known how much the essential character of his research center was going to be changed by it.

be putting together a national team to beat the Soviets in the space race but would also be invigorating the aerospace industry and strengthening the country's economy. NASA's new style of managing large endeavors might even demonstrate a cooperative means by which other national and international needs, such as the alleviation of poverty, could be met.

Thompson's slogan was his own, but the broader message belonged to bigger thinkers. Whether Thompson was conscious of it or not, the phrase "retain our competence and contract out our capacity" echoed a more sweeping vision of his time, one that was an essential part of John F. Kennedy's "New Frontier." An ambitious program of space exploration would make the United States an overall healthier society, Kennedy declared during the 1960 presidential campaign. "We cannot run second in this vital race. To insure peace and freedom, we must be first. . . . This is the new age of exploration; space is our great New Frontier." A successful space program would help in the ultimate defeat of communism by showing to all peoples of the world the great things a western democratic and capitalistic society can do when its resources are effectively mobilized. NASA would make manifest the essential superiority of the American way of life.³

Spaceflight Revolution



L-64-6455

President Kennedy's (actually Vice-President Lyndon B. Johnson's) choice for NASA administrator, James E. Webb, sits between Langley Director Floyd Thompson (left) and the NACA's retired executive secretary, John F. Victory (right), at the 1964 NASA Inspection held at Langley. Although Thompson had some memorable run-ins with Webb, the two were much alike. Both were country boys (Thompson from Michigan, Webb from North Carolina) with ruffled collars, corn-pone accents, and down-home homilies. They were also highly intelligent, complex, and cunning.

A dynamic new union of science, technology, and government—or what NASA Administrator Webb called the “university-industry-government complex”—would lead the charge in this campaign for a better world. NASA, above all other national institutions, would help to forge this relationship, which would serve as the means for winning the contest with the Soviet Union, for solving pressing social and economic problems at home and abroad, and for accelerating the pace of progress in the human community. The elaborate teamwork necessary for spaceflight programs would force some major changes and adjustments in the workings of existing institutions, but the end result would be for the best. Traditional values, those worth keeping, would be retained. But through the new partnership, each of the team members, including NASA, would become stronger.⁴

Given his democratic leanings and his position of responsibility within the space program, not even a stubborn old curmudgeon like Thompson

was outside the rising tide of thinking about how the world was changing and how even successful places like NASA Langley would also have to change if they were to contribute to and be a vital part of the new order. Thompson could be brusque with Webb, as at the Hilburn press conference, but in technological spirit he and the NASA administrator stood on common ground. "Every thread in the fabric of our economic, social, and political institutions is being tested as we move into space," Webb stated in a 1963 speech on the meaning of the space program.

Our economic and political relations with other nations are being reevaluated. Old concepts of defense and military tactics are being challenged and revised. Jealously guarded traditions in our educational institutions are being tested, altered, or even discarded. Our economic institutions—the corporate structure itself—are undergoing reexamination as society seeks to adjust itself to the inevitability of change.⁵

Thompson, in his much less publicized talks around Langley, often echoed the same sentiments. Not even the oldest and best American institutions could go on as before, unaffected, in light of the technological revolution that was taking place as humankind moved into space. Even a place like NASA Langley would have to make some major adjustments, and Thompson knew it—no matter what curt remark he might make to the contrary.

The Organization

Apart from meeting the sizable personnel requirements of the STG, Langley laboratory initially did not change much to meet the growing demands of the nascent space age. Some new boxes were drawn on the organization charts, and a few old ones eliminated. Some existing divisions and branches received new names and experienced reorganizations, and a few significant new research sections and branches were built around emerging space disciplines (for example, the Space Applications Branch of the Full-Scale Research Division created in December 1959 and the Magnetoplasmadynamics Branch of the Aero-Physics Division created in May 1960). Several major project offices also came to life at the laboratory in the early 1960s, but, for the most part, everything about the formal structure of the laboratory remained the same as before. Thompson and his senior staff believed that the organization of the laboratory for its general applied aerodynamic research under the NACA in the late 1950s would serve the new combination of aeronautics and space equally well. When Langley's diversified capabilities needed to be focused on mission plans or specific program goals, ad hoc task forces, steering committees, study groups, and other "shadow organizations" that usually did not appear on the organization charts were created.

The organization chart of 1962 shows the continuity in Langley's structure from the 1950s into the 1960s even though four years had passed since

Spaceflight Revolution

the changeover of the NACA to NASA and one year had passed since President Kennedy had committed the country to a manned landing mission to the moon by the end of the decade. In the summer of 1962, Langley Research Center consisted, as it had since the mid-1950s, of three major research *directorates*. Heading each directorate was an *assistant director*. This person was responsible for overseeing the work being done in the subsidiary research *divisions*. In 1962 each research directorate had three research divisions, for a total of nine at the center. Within the nine research divisions were some 50 *branches*, plus a number of *sections*, *offices*, *facilities*, *shops*, and *testing units*. Typically, a division numbered between 100 and 150 full-time research professionals. In the management formula, 3 nonprofessionals, that is, secretaries, mechanics, data processors and the like, were needed to support one researcher. That did not mean that every division employed 300 to 450 support people; none in fact did. The research divisions instead received much of their nonprofessional assistance from two supporting directorates. One of these directorates, "technical services," employed the mechanics, modelmakers, electricians, and other technicians necessary for keeping the shops, testing facilities, and the rest of the infrastructure of the research operation alive. The other supporting directorate, "administrative services," handled fiscal matters, personnel affairs, the photo lab, the library, and the publications office as well as the rapidly increasing requirements for procurement.⁶

Until early in 1962, the research directorates did not have names or any official designation; on the organization charts were three boxes simply labeled "Office of Assistant Director" with no way to distinguish them, apart from knowing who the particular assistant director was and what divisions he directed. In February 1962, Director Thompson and Associate Director Charles J. Donlan decided to remedy this situation. There were three directorates, they thought, so why not call them "Group 1," "Group 2," and "Group 3."⁷

Named to head Group 1 at the time of this nominal reorganization was Clinton E. Brown, formerly the chief of the Theoretical Mechanics Division. This division was one of several smaller Langley divisions that in the early 1960s were focusing on the study of lunar missions. Brown replaced Hartley A. Soulé, who retired. The new Analysis and Computation Division (ACD), whose chief was Paul F. Fuhrmeister, was part of Group 1. This division was established in January 1961 by combining the Analytical and Computation Branch of the Theoretical Mechanics Division with the Data Systems Branch of IRD. The goal of ACD was "to allow more effective management at the Center in the development and utilization of data systems for data reduction services and for theoretical analysis requirements."⁸ Also within Brown's group were IRD, headed by electrical engineer and future assistant director Francis B. Smith, and the Theoretical Mechanics Division (in June 1963, renamed the Space Mechanics Division), led by Dr. John C. Houbolt, the champion of the lunar-orbit rendezvous concept for Project Apollo.

LANGLEY RESEARCH CENTER

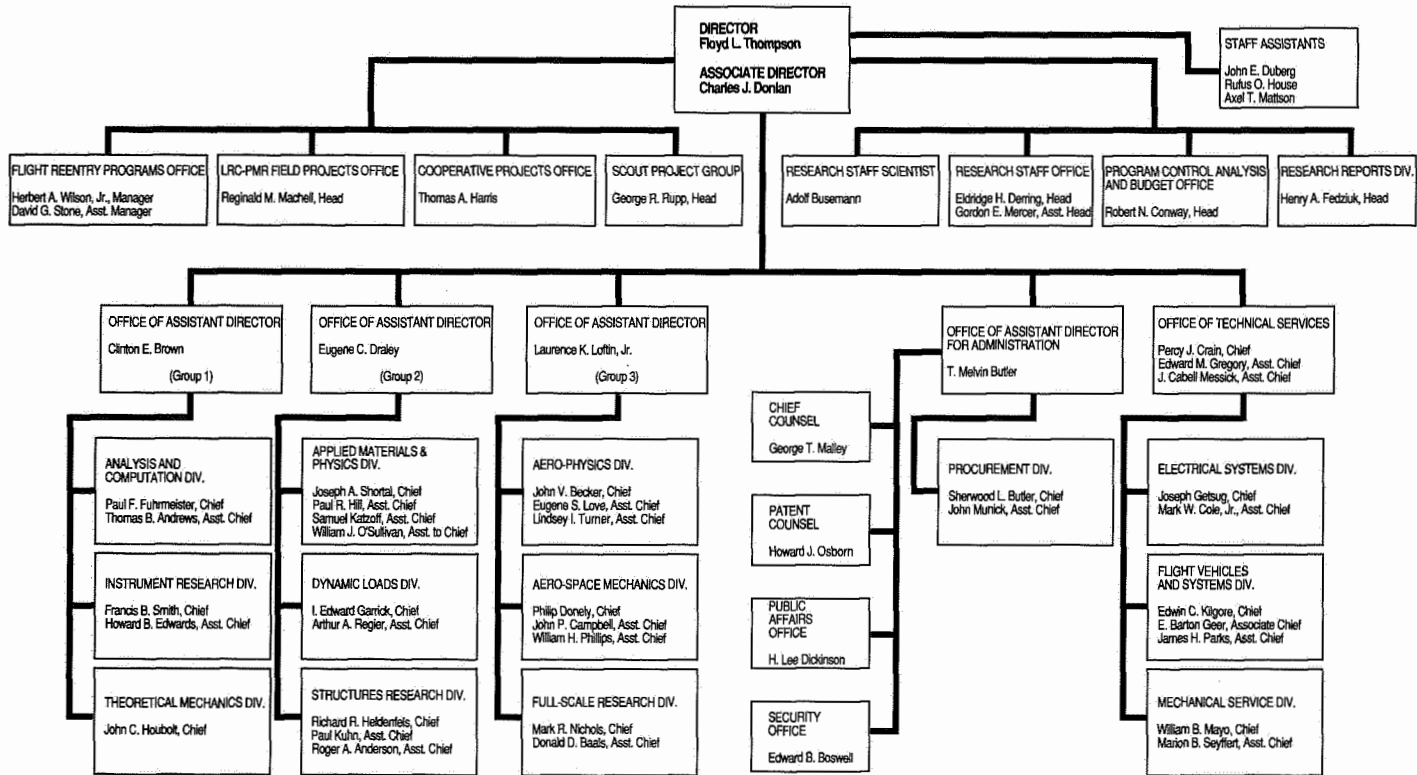

Organization chart of NASA Langley Research Center, summer 1962.

Spaceflight Revolution

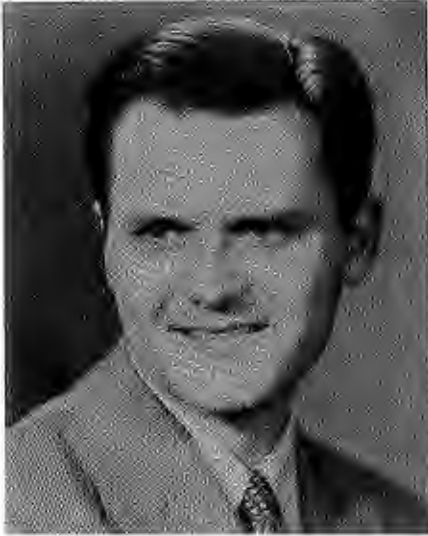

L-60-5232

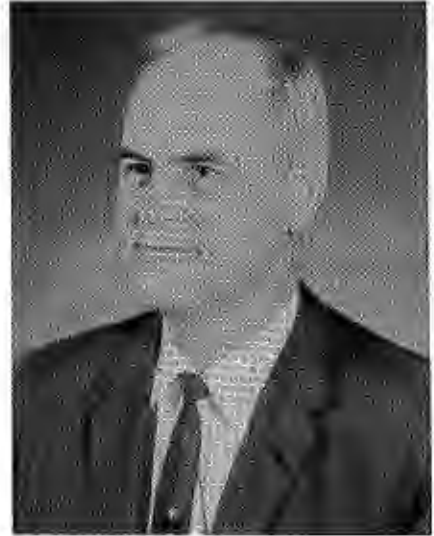

L-64-9585



L-77-3336

The heads of Groups 1, 2, and 3: Clinton E. Brown (top left), Eugene C. Draley (top right), and Laurence K. Loftin, Jr. (bottom). When these groups were baptized in February 1962, the three men had been working at Langley for a combined 62 years.

Change and Continuity

Heading Group 2 was Eugene C. Draley, who had been serving as an assistant director since November 1958. Within this directorate was Joseph A. Shortal's (Class of 1929, Texas A&M) Applied Materials and Physics Division, the reincarnation of PARD, which had been dissolved in December 1959. PARD, created near the end of World War II, had developed the methods of rocket-model testing at Wallops and had provided instrumented flight data at transonic and supersonic speeds important for the design of the country's postwar high-speed jets and ballistic missiles. Led in its early years by Bob Gilruth, the old PARD had served almost unwittingly as Langley's training ground for the space age. One year after the birth of NASA, and in view of the changed programs and responsibilities of PARD, Langley had changed its name to the Applied Materials and Physics Division.⁹ The Dynamic Loads Division, headed by I. Edward Garrick, an applied mathematician who had graduated from the University of Chicago in 1930, and the Structures Research Division, headed by MIT aeronautical engineer (Class of 1942) Richard R. Heldenfels, were also in Group 2.

Laurence K. Loftin, Jr., a mechanical engineer who came to work at Langley in 1944 after graduating from the University of Virginia, had served as the technical assistant to Floyd Thompson since December 1958. When Henry Reid relinquished his duties on 20 May 1960, Loftin began working for the laboratory's director. On 24 November 1961 Loftin replaced John Stack as Langley's third assistant director when Stack moved up to take charge of the agency's aeronautical programs at NASA headquarters. In practice, Loftin served also as Langley's director for aeronautics. When, four months later, Thompson assigned group numbers to the directorates, Loftin remained in charge of what was called from then on Group 3.

Group 3 was home to the Aero-Physics Division, headed by hypersonics expert John V. Becker (M.S. in aeronautical engineering, New York University, 1935). The roots of this division went back to the old Compressibility Research Division of the late 1940s and 1950s, in which NACA researchers had studied the vexing problems of high-speed flight in new wind tunnels and other unique test facilities. In December 1958, Langley had redesignated this division the Supersonic Aerodynamics Division. But this name, which Becker and others did not like because it did not capture the range of research areas covered by the division's work, did not last long. Seven months later, after another reorganization, it was rebaptized the Aero-Physics Division, a title that then lasted until the major organizational shake-up brought on in 1969 and 1970 by Thompson's successor as center director, Edgar M. Cortright.

The second division in Group 3 was the Aero-Space Mechanics Division, led by Philip Donely, an aeronautical engineer who had graduated from MIT in 1931. Like a few other parts of Langley, this division was created not long after the establishment of NASA, during the reorganization of September 1959. Essentially, the Aero-Space Mechanics Division combined two older aeronautical research groups: the Flight Research Division and

Spaceflight Revolution



L-64-6446

On the Langley tarmac in May 1964 to welcome Raymond Bisplinghoff, director of the Office of Advanced Research and Technology (OART) at NASA headquarters, are, left to right, Floyd Thompson, Langley director; Raymond Bisplinghoff; T. Melvin Butler, chief administrative officer; Eugene C. Draley, head of Group 2; and Laurence K. Loftin, head of Group 3.

the Stability Research Division, both of which dated to the late 1930s. As with many other changes at the time, the establishment of the Aero-Space Mechanics Division reflected the snowballing of space-related research activities at Langley and the de-emphasis on aeronautics. In a directorate such as this, where aeronautics always had been the byword, center management was reclassifying activities to show how even the airplane flight research groups were tackling critical problems in the new regime of space. Nobody in Donely's division much liked the new name, because it eliminated the word "flight" to add the word "space." Effective 30 June 1963, after a reorganization, Donely's division became the Flight Mechanics and Technology Division, a redesignation that stuck until the Cortright reorganization, when the political advantages of calling everything "space"-this or "space"-that had mostly passed.

The third division in Loftin's group was the Full-Scale Research Division, which comprised several large aeronautics groups clustered around the laboratory's larger wind tunnels. This division began in the early 1940s but had recently expanded in May 1961 with the addition of the former Unitary Plan Wind Tunnel Division as one of its major research branches. Aeronautical engineer Mark R. Nichols, a 1938 graduate of the Alabama

Polytechnical Institute (later Auburn University), led this division through the 1960s.

Not surprisingly, all three assistant directors and all nine division chiefs, as well as the director and associate director, were former employees of the NACA. The average age of these 14 men in 1962 was just over 44. When Lindbergh made his famous transatlantic crossing in 1927, they were young boys. Many of them remembered the flight of “Lucky Lindy” as a seminal event in their lives, launching them toward professional careers in aeronautics. Only two of them, ACD’s Fuhrmeister and IRD’s Smith, had not worked at NACA Langley during World War II, but they arrived only a few years later.

A few important changes in the structure of the organization occurred after 1962. A handful of new assistant directors would be assigned. In October 1965, IRD would be split into two divisions: a new IRD and a brand new Flight Instrumentation Division. Both divisions would belong to Group 1. In the spring of 1964, a fourth major research directorate, the Office for Flight Projects, was formed to accommodate the growing number of special projects at the laboratory. Under this office was placed the Flight Reentry Programs Office, which handled Project Fire, the Lunar Orbiter Project Office, the Manned Orbiting Research Laboratory (MORL) Studies Office, the Scout Project Office, and the Applied Materials and Physics Division (the old PARD). The first assistant director of this new Office for Flight Projects was Gene Draley, who moved over from Group 2. Replacing Draley as head of Group 2 was Dr. John E. Duberg (Ph.D. from the University of Illinois, Class of 1948). Duberg was responsible for a directorate comprising only the Dynamic Loads Division and the Structures Research Division. The Applied Materials and Physics Division, which for its entire history had been the maverick in Langley’s overall organization, moved over with Draley to Flight Projects.¹⁰ Curiously, this fourth research directorate was not called “Group 4.”

Thompson’s Obscurantism

Langley’s organization charts did not reveal the substance of the laboratory operation. In keeping with a long-standing tradition of obscurantism fathered by George W. Lewis, the NACA’s politically shrewd director of research in Washington from 1919 to 1947, Langley Directors Henry Reid and Floyd Thompson never made the structure of the laboratory too apparent. If they had, they thought, then outsiders—and that category of suspicious people included Langley’s own superiors at NACA/NASA headquarters in Washington—would be able to interfere with what was going on inside the laboratory. Micromanagement was something that the directors of the field centers and their research staffs definitely did not want.¹¹

Spaceflight Revolution

“Thompson was a great one for saying that you couldn’t be too sensible about this kind of stuff,” remembers Larry Loftin, assistant director for Group 3. He wanted to “keep things confused so that the people at headquarters wouldn’t really know what was going on.” Thus, Langley’s formal organization, following the NACA way, was kept deliberately vague. Loftin remembers one instance from the early 1960s when a concerned Bernard Maggin from the Office of Aeronautical and Space Research in NASA headquarters asked Thompson outright how many people were working on space projects under William J. O’Sullivan, Jr., in Langley’s Applied Materials and Physics Division. Thompson just looked at Maggin grimly (to some colleagues, the Langley center director was known as “The Grim Reaper”) and said, “I’m not going to tell you.”¹²

And he never did tell Maggin. Thompson could get away with veiling the organization because of his many years with the NACA, the outstanding reputation of Langley Research Center both inside and outside the agency, and the power Langley wielded early on within NASA. This policy of obscurantism, however, was not something that headquarters liked or wanted continued much longer; it was not to be carried on by Thompson’s successor. Edgar M. Cortright, the headquarters official named by NASA Administrator Jim Webb in March 1968 to replace Thompson, believed that it would be to Langley’s advantage if headquarters had a more detailed understanding of the laboratory operation. So, in 1969 and 1970, when he put Langley through what was the most sweeping and traumatic reorganization in its then more than 50-year history, Cortright made certain that the titles in all the boxes on the organization charts indicated exactly what staff members did. This was just what Thompson had avoided.

Another hallmark of Thompson’s management style was generating spirited competition among his research divisions. He did not want any one group to have all the research opportunities in a given technical area. No one group should be doing all the reentry heating work, all the space station design, or all the supersonic research. Monopolies such as that, though they might seem to prevent duplication of efforts, bred complacency. Better to have several research groups tackling the same set of problems from different angles.

This philosophy of creative research through friendly competition led to the formation of shadow organizations and invisible lines of organizational communication and responsibility within Langley—a process that would become known to management theorists by the 1990s as “nonlinear” thinking. For example, besides serving as assistant director for Group 3, Loftin also was responsible for all the aeronautics efforts at the laboratory—that included all of the aeronautical work in the Structures Research Division, which was technically under the auspices of Gene Draley’s Group 2. As part of his everyday duties, Loftin had to review and approve all the important paperwork related to the aeronautical activity of someone else’s directorate.¹³

This arrangement did create some tension but frequently resulted in a positive outcome. "There was enormous technical competition between the divisions at Langley," remembers Israel Taback, a longtime member of IRD who came to work at the laboratory in the early 1940s and stayed into the 1980s. "People would fight with each other over technical details. That was all very healthy. The end result was a battle of ideas. Ideas that had merit tended to float to the surface. The good ideas won."¹⁴

The Sinking of Hydrodynamics—and Aeronautics?

Only one major research division completely disappeared at Langley during the first years of the spaceflight revolution: Hydrodynamics. This division had done pioneering work in the field of waterborne aircraft research since 1930. Langley management decided to dissolve Hydrodynamics in late December 1959 and reassign its roughly four dozen personnel to other divisions. Many of its staff members went to Dynamic Loads, which dated back to the old Aircraft Loads Division of World War II and had specialized in the study of such problems as aeroelasticity, flutter, buffeting, ground wind loads, gust loads, and aircraft noise. In recent months, however, Dynamic Loads, like most other Langley divisions, had been taking on work related to Project Mercury and the space program.¹⁵

With the group that moved to Dynamic Loads went the continued responsibility for operating the High-Speed Hydrodynamics Tank, a 2177-foot-long, 8-foot-wide, and 5-foot-deep towing test basin. This long concrete water channel was located in the far West Area of Langley Field alongside the Dynamic Loads Division's Landing Loads Track.* In the High-Speed Hydrodynamics Tank, NACA researchers in the mid-1950s had evaluated the performance of floats for the navy's Martin YP6M-1 Seamaster jet-propelled flying boat. They had worked to develop retractable "hydro-skis" for the navy's experimental little XF2Y-1 Sea Dart jet fighter built by Convair (still to this day the only supersonic seaplane ever to fly). In addition, they had searched for a way to provide water-based aircraft with the combat air performance of comparable land-based planes. These investigations contributed information essential to the design of several experimental military vehicles including a "panto-base" airplane, a proposed amphibious type that could operate from concrete runways, grass, mud, snow, sandy beaches, or even from seaplane ramps and floating rafts.¹⁶

Those members of the Hydrodynamics Division who did not move to Dynamic Loads became members of the Full-Scale Research Division. This was the largest single division at the laboratory, and it was essentially composed of aeronautical researchers who staffed the larger wind tunnels. John B.

* The Landing Loads Track was an outdoor facility that simulated aircraft landing loads and motions through the braking and impact of a catapult-launched test carriage onto a hard runway-like surface.

Spaceflight Revolution

Parkinson, Hydrodynamic's ever-faithful chief and the 1957 winner of the first Water-Based Aviation Award given by the Institute of Aeronautical Science, was reassigned to this division. Parkinson had worked in Hydrodynamics since coming to Langley in 1931. He accepted with reluctance his new assignment as "Aeronautical Research Scientist, Aerodynamics," which then Associate Director Floyd Thompson invented for him. In that position, Parkinson was to help in program planning and serve as "the Center's consultant for the consideration of future vehicles that operate on or in the water as part of their mission and other future vehicles for which water landing or other hydrodynamic requirements affect and modify design requirements." As Parkinson would no longer be a division chief, Langley had to request an "excepted position" for him from the civil service that would allow him to retain his present salary of \$15,500. Within two years of the dissolution of Hydrodynamics, Parkinson left Langley for a job overseeing the management of aerodynamics research in the Office of Advanced Research and Technology (OART) at NASA headquarters.¹⁷

Parkinson and his colleagues took with them to the Full-Scale Research Division the responsibility for maintaining what had always been Hydrodynamics premier facility, "Tank No. 1," a unique 2900-foot indoor seaplane towing basin on the shore of the Back River in the East Area. This tank was designed in 1930 by NACA civil engineer Starr Truscott, who according to Langley lore was a descendant of the Wild West outlaw Belle Starr and a veteran of the construction of the Panama Canal. The NACA's original hydrodynamics research program had begun in Tank No. 1 when, 29 years before, Truscott, Parkinson, and fellow engineers had employed it to test floats that were eventually used on several American seaplanes, including the Sikorsky twin-float "Amphibian," which set speed records in the 1930s. Data gained from work in this facility also contributed to the development of the famous Clipper flying boats, the romantic ocean-hoppers that before World War II had trailblazed air routes and carried hundreds of paying passengers over all the oceans of the world. In the big water tank, the NACA had studied the design characteristics of most American floatplanes and the performance of nearly all the early U.S. Navy flying boats that would be used for air-sea rescue, antisubmarine patrol, and troop transport in World War II. In the enlarged version of the tank (it was lengthened to its full 2900 feet from an original 2000 feet in 1937) and in its 1800-foot-long little brother, Tank No. 2 (built adjacent to it in 1942), Langley engineers discovered ways to ease the shock on a landplane when crash-landing or ditching in the water. Both tanks were equipped with an overhead electric carriage from which a dynamic model could be suspended and towed at up to 80 miles per hour, which was sufficient to make a model take off from the water and fly at scale speed. As the model was moving along the surface, researchers took motion pictures and recorded measurements demonstrating the aircraft's stability, controllability, water resistance, drag, and spray characteristics. The tanks were equipped with catapult devices,

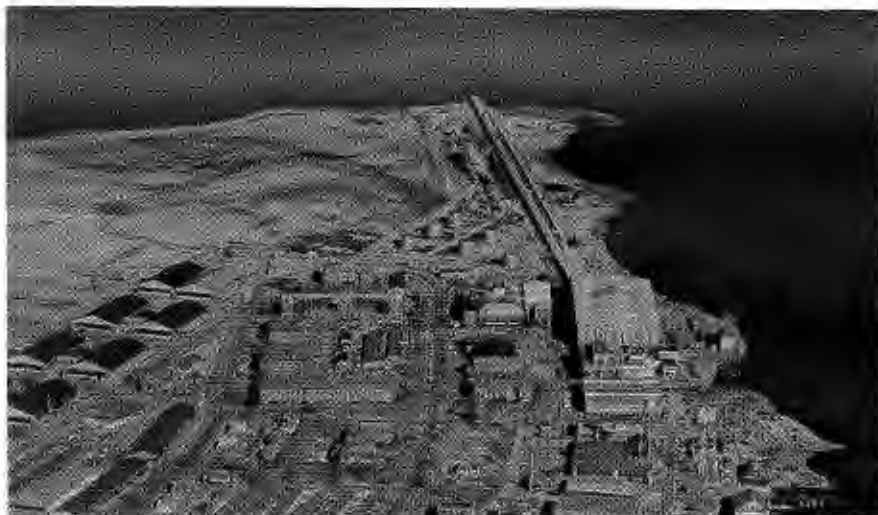

L-59-8685

Aerial view of Langley's East Area. The largest building on the shore of the Back River is the Full-Scale Tunnel; the long building seeming to run from the top of the tunnel is Tank No. 1.

for the study of the free-launched landing characteristics of airplanes and with mechanical wave-makers, for the simulation of takeoff and landing in rough water.¹⁸

On the eve of the dissolution of the Hydrodynamics Division, researchers in Tank No. 1 were studying the characteristics of revolutionary VTOL machines over water. They were even investigating the requirements of a supersonic seaplane and a prototype "ground-effect" machine, a platform-like vehicle that could hover and move just above the ground by creating a cushion of supporting air between it and the ground surface. Nobody, not even the U.S. Navy, was interested enough in the research going on in Langley's Hydrodynamics Division to ask NASA to keep it alive. Two ambitiously experimental Martin YP6M-1 Seamaster jet seaplanes had recently been lost due to design failures; the navy was about to terminate its entire flying-boat program; and Martin, one of the most dedicated builders of flying boats, was on the verge of moving into the guided missile business.¹⁹ Langley's Hydrodynamics Division, historic as it was, had apparently outlived its usefulness. Tank No. 2 had already been deactivated in April 1958 after 16 years of continuous use. Beginning on the first working day of 1960, historic Tank No. 1 would be placed on standby status, with no operating personnel regularly assigned to it. It became an abandoned facility that was to be used "only to meet the requirements of such special needs as they might arise."²⁰ Shortly thereafter, NASA would give complete control over the tank to the navy.

Spaceflight Revolution



L-61-6509

A Langley engineer prepares a model of the proposed air force X-20 Dyna-Soar aerospace plane for testing in Tank No. 2 in 1961.

Langley management explained its decision to abolish the Hydrodynamics Division by pointing to “the declining need for hydrodynamics research as it applies to seaplanes and other water-borne aircraft.” Although that justification was apparently legitimate, it was only half the story. The other half was that the exigencies of NASA’s space program were sweeping over Langley like a tidal wave and, in this case, engulfing an entire aeronautics-oriented division whose activities, facilities, and reason for being suddenly seemed antiquated. It did not matter that the division had been contributing to Project Mercury by making studies of the water landing characteristics of the capsule; it was better to get rid of the division and make its staff more clearly a part of the new regime of space. “In view of the changing nature of the nation’s research programs,” conceded Langley Director Henry Reid, “it is felt that the experienced personnel of the Hydrodynamics Division could best be utilized by transferring them to the staffs of divisions which have assumed increased space research responsibilities in recent months.”²¹

As indicated by the elimination of the Hydrodynamics Division in 1959, Langley management was doing everything it could to transform Langley into an R&D center ready-made for the space age. But aeronautical engineers and their passion for airplanes and other winged flight vehicles did not completely disappear at the center. Floyd Thompson was not about to let aeronautics die at the historic NACA facility where he had worked

Aeronautics and Space Work as Percentages of
Langley's Total Effort, 1957-1965

Effort	1957	1958	1959	1960	1961	1962	1963	1964	1965
Hypersonics	6	9	6	9	6	5	7	9	8
Supersonics	12	16	13	13	16	15	12	12	10
Subsonics	5	6	8	5	5	4	3	3	3
Special Types	8	9	9	7	7	7	4	3	3
Aeronautics Total	31	40	36	34	34	31	26	27	24
Space Total	69	60	64	66	66	69	74	73	76

Source: "Distribution of Effort" pie charts in folder labeled "Research Effort," Laurence K. Loftin, Jr., Collection, Langley Historical Archives.

since before the Lindbergh flight and where so many ideas important to the progress of American aviation had been born.²²

The place of aeronautics at Langley was nevertheless to change significantly in the wake of Sputnik. For the NACA to metamorphose successfully into NASA, aeronautics, out of political necessity, had to give up the center stage that it had enjoyed for over five decades so that an overnight sensation could now dazzle in the spotlight. The astronaut rocketing into the darkness of space would now get top billing; the aviator flying through the wild blue yonder, and the engineers and scientists who made that flight possible, would play the part of supporting actors. Already by the spring of 1958, aeronautics at Langley made up only 40 percent of the total work done at the center. By 1965 aeronautics would plummet to its lowest point, a measly 24 percent. The space program was outshining older stars.

For aviation enthusiasts, this turn of events proved traumatic. Veteran aeronautical engineer Raymond L. Bisplinghoff, who directed the OART at NASA headquarters from 1962 to 1966, put it mildly when in a 1983 memoir he stated that the formation of NASA had

a dramatic, and at first deleterious, influence on the on-going program of aeronautical research. The new space tasks were often under scientists who worked on a space problem for one week then switched back to aeronautics the next week. . . . The massive priority which the country, from the president on down, placed on eclipsing the Russian lead in spaceflight had a profound influence on the NACA aeronautical staff as they assumed positions in the new agency. Many took advantage of opportunities to move to higher grades and levels of responsibility in space activities. As a result, many moved from aeronautical research tasks to space program management tasks.²³

Spaceflight Revolution

Others, such as Langley's fiery director of aeronautics, John Stack, were so sure that the first "A" in NASA was being erased forever that they decided to leave the *space* agency entirely. At the time, especially after NASA's annual R&D budget for aeronautics fell below a million dollars in 1962, these disillusioned aviation enthusiasts could not have known how extensively, or how successfully, NASA would rebuild its aeronautics programs following its major buildup for space.

In the late 1950s and early 1960s, all that the aviation enthusiasts could think about was the overwhelming dominance of space over aeronautics. In private, many Langley aeronautical engineers held NASA's manned spaceflight programs in contempt, especially the quest to land men on the moon, believing it to be the height of dishonesty for their organization to undertake such a mission, even if it could be done, when it was not worth doing. John V. Becker, a talented Langley researcher who by the late 1940s had already shifted his attention to hypersonics and the possibilities of an *evolutionary* progression into space via transatmospheric vehicles like the X-15, remembers that his longtime colleague John Stack was "not really much interested in the reentry problem or in space flight in general." For Stack, even the X-15 was a program barely worth supporting, and he did so "with only the semblance of the notorious promotional fire he could generate if he was really interested."²⁴

John Stack and his team of aeronautical engineers reserved their enthusiasm for advanced high-speed military jets and for a viable commercial SST. As Becker remembers about his volatile colleague, Stack developed "a hostile, adversary attitude towards Space, perhaps because it threatened to drain resources that otherwise might belong to aeronautics." When the Apollo program was established in 1961, Stack told Becker, "I don't buy this 'to the Moon by noon' stuff." Unimpressed by the great size and complexity of the booster rockets, he compared von Braun's Saturns to the impressive but very stationary Washington Monument and sided with some early but abortive attempts inside NASA to find viable air-breathing aircraft-like launch systems for the manned space missions. According to Becker, Stack, even after leaving NASA in 1962 for an executive position with Republic Aviation, "continued to favor advanced aircraft as opposed to space projects."²⁵

Most members of the Stack team, as well as many of Langley's other aviation enthusiasts, felt exactly the same way. The hard-core aeronautical engineers in the years following Sputnik were in Mark R. Nichols' Full-Scale Research Division and in Philip Donely's Flight Mechanics and Technology Division, both of which were part of Group 3. Inside the wind tunnels and flight hangars of these two divisions, torrid love affairs with aerodynamics, with high lift/drag ratios, with satisfactory flying and handling qualities, and with the comely shapes and exciting personalities of airplanes and helicopters continued to flourish long after the formation of the STG. Far too numerous to count or name them all, the strongest adherents to aeronautics



L-59-5435

If accomplished high-speed aerodynamicist John Stack looks disgruntled in his staff photo from 1959, it may be because of the growing predominance of the space program at Langley.

during the 1960s can be spotted simply by looking at an organization chart or thumbing through the Langley phonebook noting who belonged to these divisions. From top to bottom, these men were the “aero guys.”

And they were not happy. In the aftermath of the Sputnik crisis, “there was a real strong emphasis on getting people out of aeronautics and into space,” remembers Mark Nichols, the Full-Scale Research Division chief. In fact, Nichols himself was moved. In 1959, Floyd Thompson put Nichols in charge of Langley’s first space station committee, choosing him, one of the laboratory’s most die-hard aeronautical engineers, as a lesson to all others. Laurence K. Loftin, Jr., a devoted aeronautical researcher and aerodynamic flutter expert, also found himself immersed in planning for both space stations and lunar missions in the early 1960s. As this substitution pattern became clear, the air-minded at Langley found themselves in “an adversarial mode with management, which was always trying to take our people and put them into space.” Nichols and his buddies looked “for ways of resisting this,” but were not successful.²⁶

No one was unhappier with this development than Langley’s number one “aero guy,” John Stack. No one at Langley grew more disgruntled over what he believed the space agency was doing *to*, and not *for*, the country’s precious aeronautical progress. Stack, the brilliant and outspoken head of aeronautics, set the tone for the numerous dissatisfactions of the air-minded engineers at the center during the first years of the space revolution. This was true especially after he, one of the most decorated and powerful men at the laboratory, started to lose out in some infighting within the Langley front office. Most notably, in March 1961, Thompson made Charles Donlan,

Spaceflight Revolution

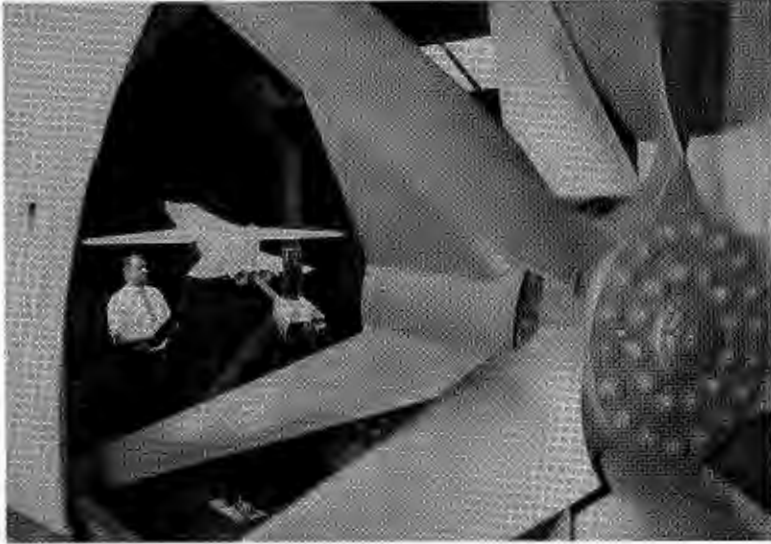

L-65-2870

One of the aeronautical passions at Langley in the late 1950s and early 1960s was variable wing sweep, a technology by which an airplane's wings could be mechanically adjusted to different sweep angles to conform to either subsonic, transonic, or supersonic flight requirements. In this photo from May 1965, a wind-tunnel engineer checks the mounting of a scale model of the General Dynamics F-111A, the air force's version of the nation's first variable-sweep fighter. The F-111A first flew in December 1964; the navy version, the F-111B, made its initial flight in May.

and not Stack, Langley's associate director. A man of rare accomplishments and visionary ambitions, Stack was not accustomed to being passed over. Not even NASA's heavy involvement in the national SST program could keep Stack working for the *space* agency.

However preoccupied NASA became in the 1960s with space-related matters, at Langley aeronautics research continued and resulted in outstanding contributions to everything from hypersonic propulsion to the handling qualities of general aviation aircraft.* One reason for the unexpected degree of success, ironically, was the fact that aeronautics did not receive much attention from NASA management or from the public at large. The Apollo program and all its related activities so consumed NASA headquarters that it let the aeronautical engineers do as they pleased. In this sense, the aero-

* Originally, I planned to include a long chapter dealing specifically with aeronautics. As the study's thesis evolved, however, I realized that, although the spaceflight revolution certainly affected the aeronautics efforts in many significant ways, I could not do justice to the complete history of aeronautics at Langley during the 1960s within the confines of an already long book. So, I decided not to cover the aeronautical programs and leave them for separate treatment at some later date, perhaps by someone other than myself.

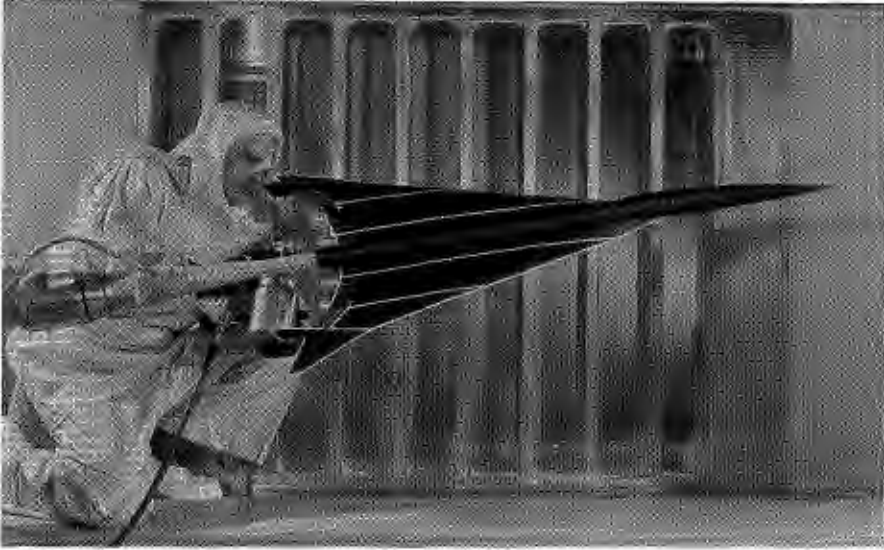

L-70-1386

In this photo from 1970, a technician readies a model of Langley's own pet Supersonic Commercial Air Transport, known as SCAT 15F ("F" for fixed wing), for testing in the Unitary Plan Wind Tunnel.

nautical work at Langley kept much the same personality and flavor as during the NACA era when the engineers, not the bureaucrats in Washington, had been in charge.

But oddly, in retrospect, the rearguard of aviation enthusiasts at Langley in the 1960s in some ways resembled the vanguard of the spaceflight revolution. As much as the air-minded hated NASA's emphasis on space exploration, these air-minded engineers and scientists nevertheless became equally caught up in their own dreams of monumental new accomplishments. Perhaps it was just the nature of the revolutionary times brought on by Sputnik and President Kennedy's New Frontier to think so grandly and to feel that the old limitations no longer applied.

NASA's aeronautical engineers had their own Apollo program in the 1960s: the design of the most revolutionary aircraft ever built—a commercial supersonic airliner capable of flying two or even three times the speed of sound and crossing the Atlantic from New York to London or Paris in a few hours. This dream compared favorably with the lunar landing because an SST would have such immense economic, political, and social significance that it would change how humankind traversed the face of the earth. The Apollo program would accomplish nothing similar. Neither, of course, would the aeronautical engineers' national SST program because the U.S. Congress killed it in 1971. In this sense, too, the space cadets emerged "one up," for

Spaceflight Revolution

they had their spectacular moment with the manned lunar landings; the “aero guys” never did.

Growth Within Personnel Ceilings

Despite the dissolution of the Hydrodynamics Division and the wane of aeronautics, Langley’s formal organization did not change significantly in the early 1960s. This was in part because the center did not grow much bigger. By the changeover to NASA, Langley Research Center was already a large operation. It had greatly expanded during its NACA history from a few small buildings in an isolated corner of the military base prior to World War II to a 710-acre complex on both sides of the air force runways. It was now an establishment that included 30 major wind tunnels and laboratories and whose replacement worth to the federal government was estimated at nearly \$150 million. In 1958 the center paid approximately \$6 million in operating expenditures, including nearly \$2 million just for electric power. Its annual payroll stood at \$22 million. Its full-time civil service staff numbered about 3300, of whom approximately one-third were engineers, scientists, mathematicians, and other professional people.²⁷

With the transition to NASA, the size of the Langley staff actually became a little smaller before it grew any larger: from 3795 paid employees in June 1959 to 3456 by the end of that year. The staff fell to 3191 six months after the previously auxiliary Wallops Station became an independent field installation (on 1 January 1960). In the next three years, the number rose to 4007. By June 1966 the Langley staff reached its all-time high of 4485 employees. This was nearly 1000 more staff members than Langley’s peak number in 1952. But relative to the agencywide growth of NASA in the 1960s, Langley’s expansion was actually quite moderate.

In 1958, Langley’s 3300 employees represented more than 41 percent of NASA’s total first-year civil service complement of 7966. But in 1964, the 4329 employees of the Virginia facility amounted to barely 13 percent of the agency’s entire number, which in a span of just five years had doubled and doubled again, to 33,108. In other words, while Langley *was* growing, its rate of growth was slow compared with NASA’s. At this rate Langley would be unable to retain its traditional position of dominance in the agency. NASA was adding large new manned spaceflight centers such as Marshall Space Flight Center in Alabama, the Manned Spacecraft Center in Texas, and the Launch Operations Center (in November 1963, renamed the Kennedy Space Center) at Cape Canaveral in Florida. The addition of Marshall alone had meant the mass influx of over 4000 personnel from the U.S. Army as part of the transfer of the ABMA’s Development Operations Division to NASA.

Moreover, NASA’s total personnel headcount of 33,108 in 1964 represented a diminishing fraction of NASA’s overall effort. In the late 1960s, NASA estimated that Project Apollo employed some 400,000 Americans

Change and Continuity

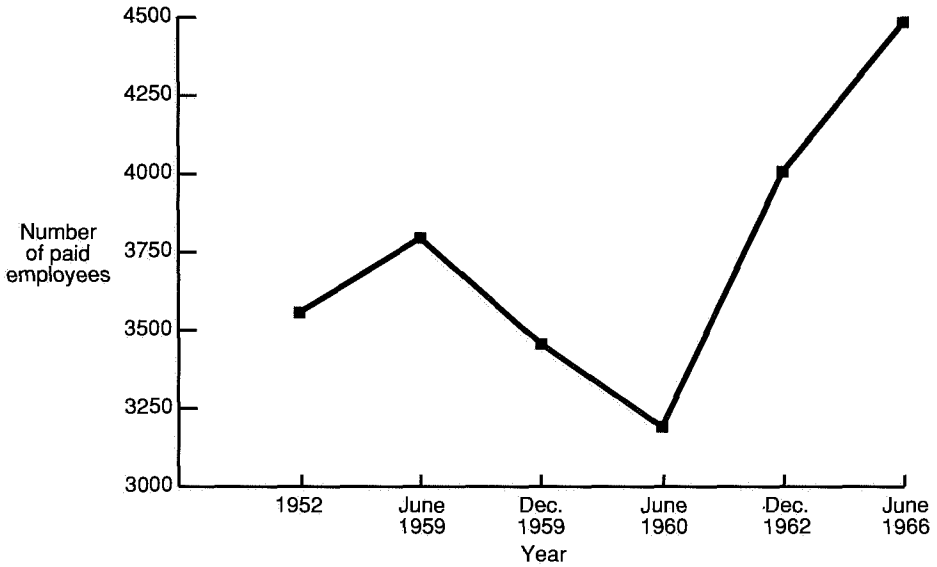

Number of paid employees at NASA Langley, 1952–1966.

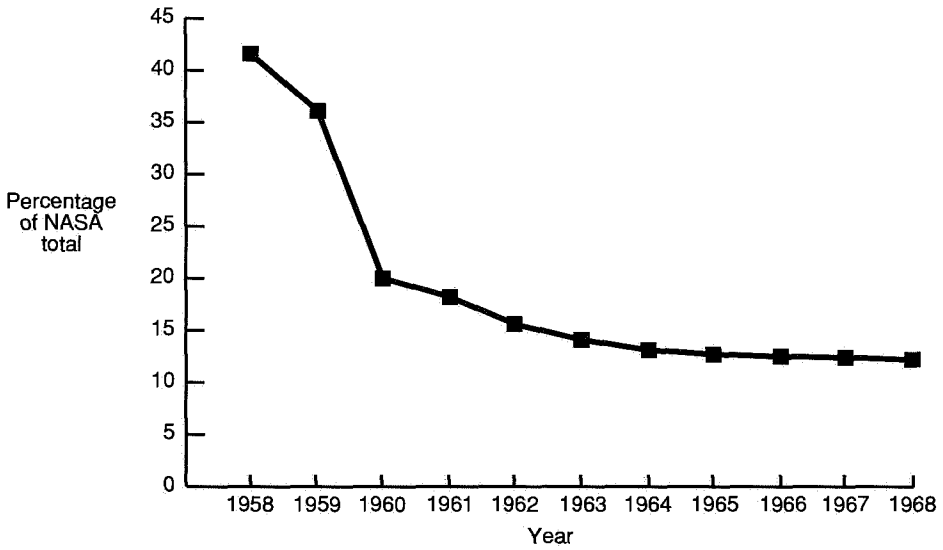

Paid employees at NASA Langley—percentage of NASA total, 1958–1968.

Spaceflight Revolution

in government, industries, and universities. NASA's civil service employees amounted to just a little more than 10 percent of the *total* NASA work force, broadly defined. The other 90 percent were contractors.

Langley was often called "Mother Langley" because it had been the mother lode for all NACA facilities. A guiding force throughout NACA history and for the first years of NASA, Mother Langley now was losing its central position in the agency. Although only a few concerned research-oriented people like Hugh Dryden would have thought about the significance of the changing personnel numbers at the time, they were symptomatic of a slow but sure decline of the formerly predominant influence of the research centers and the coming hegemony of the development centers. The personnel numbers signified the ascendancy of organizations devoted primarily not to research but to planning and conducting actual spaceflight operations and building hardware.

The trend did not go unnoticed. Thompson received a forewarning of the siphoning of research center staff funds for development centers from Earl Hilburn, whose appointment as a NASA deputy associate administrator Thompson had summarily discounted. On 9 September 1963, Thompson sent a four-page letter to NASA headquarters regarding Langley's personnel requirements. His letter underscored what he called "the problem of manpower distribution" among the NASA centers. "The immediate needs of a development program are always more easily recognized," he began, "than is the requirement for a continuing research program that lays the basic foundation of technology upon which the development program can continually depend for guidance in solving detailed technical problems."²⁸

At the heart of Thompson's illuminating letter was his concern about an ongoing tug-of-war between the manned spaceflight centers and the research centers over the apportionment (or reapportionment) of NASA's personnel quotas. The internal struggle, which the research centers were losing, was the result of work-load stresses caused by the ceilings that were imposed on the total number of people NASA could employ. The way the system worked, the agency asked for the amount of money it needed to pay salaries based on the number of people it anticipated it would employ. However, if Congress or the Bureau of the Budget found reason to trim the request, then NASA had to cut back on its staffing projections accordingly, even though the requirement to do so was not explicit in the appropriation act.²⁹

In the first years of NASA, this sort of cutting back had happened frequently because Congress, the Bureau of the Budget, President Eisenhower, and even NASA Administrator Glennan hoped to keep a rather tight lid on civil service staffing. For Glennan as well as for many others, keeping the lid on the personnel total played directly into the Republican philosophy that government was already too big. At a NASA staff conference in Monterey, California, in early March 1960, Glennan claimed that "there was a need for some kind of arbitrary limitation on NASA's size. By limiting the number of employees, NASA would limit its in-house capability and thus be forced

Change and Continuity



L-64-5210

The first woman to work as an engineer at NACA Langley was Kitty O'Brien-Joyner (left), who was also the first female to graduate with an engineering degree from the University of Virginia.



L-59-7

In 1959, Langley employed six women who were classified by NASA as "scientists." During the Apollo era, women made up 3 to 5 percent of the professional work force agencywide. The percentage of African American professionals was significantly smaller, from 1.5 to 3 percent. These percentages rose slowly for both groups as the decade proceeded.

Spaceflight Revolution

to develop the capabilities of contractors.”³⁰ This development would be far better for the American economy than hiring larger coteries of government workers. Glennan sanctioned relatively low personnel ceilings. For fiscal year 1962, for example, he approved a limit of 16,802 employees, which was less than 3 percent above the total authorized for the previous year.³¹ Naturally, no NASA center director facing the high public expectations and enormously expanded work load of the early 1960s could be expected to be happy about such limits on hiring.

The acceleration of the space program brought on by President Kennedy and his dynamic new man, James Webb, jacked the personnel ceiling up to new heights. Instead of the 3-percent increase for fiscal year 1962 proposed by Glennan, an increase of a whopping 43 percent was approved. Between 1961 and 1965 the total number of agency personnel would double, from 17,471 to 35,860.³² Given this rapid growth in the size of the NASA staff, it may seem more than a bit astonishing to find a NASA center director worried about the need for more personnel. But by late 1963, that was the case. Government controls on personnel totals even during the ensuing Democratic administrations of Kennedy and Lyndon B. Johnson were such that the only way to take care of any unforeseen requirements that occurred during a fiscal year was to transfer manpower and related financial resources among institutions. And when a transfer was needed, the research laboratories invariably lost.

On more than one occasion, subsequent to a preliminary formulation of the basic data regarding the agency’s manpower requirements at NASA headquarters, the managements of Houston and Huntsville would request a substantial number of supplementary personnel. (Earl Hilburn was warning Thompson about such a request in September 1963.) To give the space centers several hundred additional staff positions without obtaining the congressional authorization to increase the agency’s overall complement meant that NASA headquarters had no other choice but to reapportion the personnel quotas among the field centers. In other words, in order for Houston and Huntsville to get more, Langley and other research centers would have to get less.³³

In Thompson’s mind, this was a tug-of-war that the research centers, given the priorities of the space race, could not win, but which the nation could not afford to lose. “Two-thirds of the current total effort of Langley is utilized in support of the NASA space effort,” Thompson wrote to the NASA administration. “These programs have been prepared in cooperation with and approved by the OART and other cognizant program offices. They have been endorsed by NASA as essential to continued leadership in space exploration and vital to the success of such basic NASA programs as Saturn, Gemini, and Apollo.”³⁴ To support this claim, he attached to his letter (along with lists and charts illustrating “the wide range of activity” at Langley) a 10-page document listing all the then-current Langley investigations relevant to the program interests at the Manned

Spacecraft Center. This document, prepared by Axel T. Mattson, whom Thompson had dispatched as a special attaché to Houston in the summer of 1962, demonstrated that Langley was spending some 300 man-years just in support of the Texas center's projects.³⁵ If NASA continued to neglect Langley's manpower needs and persisted in improperly distributing the quotas, something would have to give. Too few people would remain at the research center to perform the total center mission. Either Langley would do all the support work, leaving little if any time for fundamental research, or the support work would have to subside, thus putting the goals of the American space program at risk.

The Shift Toward the Periphery

The trend pushing Langley from the center of NASA toward its periphery is evident not only in the personnel numbers but also in the budget figures. In 1959 the direct cost of Langley's administrative operations in terms of its obligations to pay employees and honor all those contracts (not including Wallops') that were not funded by R&D money was \$30.7 million. This amounted to 36 percent of the NASA total. In 1967, Langley spent \$64.3 million, the most money it would spend on operations during any one year in its entire history; however, this amount was less than 10 percent of the NASA total for that year. In 1959 the cost of running Langley was significantly higher than that of operating any other NASA facility. But by 1967, Langley was down to seventh place on that list, while Marshall stood at the top, at \$128.7 million, or double what it cost to operate Langley. Even the price of running NASA headquarters was nearly up to the Langley figure. Whereas \$5.5 million kept the offices in Washington going in 1959, by 1967 that figure had shot up over tenfold to a grandiose \$57 million.³⁶

NASA headquarters was growing by leaps and bounds in the early 1960s. It was a larger, more multilayered, and more active bureaucracy than had ever been the case for the NACA's Washington office. A host of headquarters officials congealed and took charge of all the programs at Langley and the other NASA centers. This meant that the field centers had to work through Washington not only for their allotment of resources but also for many levels of program initiation and administration. Also unlike the days of the NACA, the bureaucrats in Washington were now directly in charge of their own little empires. They issued major contracts to universities and industries for R&D and for design studies.³⁷ Between 1960 and 1968, the value of contracts awarded by NASA headquarters rose from 3 to 11 percent of the total value of contracts awarded agencywide. During the same period, Langley experienced a decline from 35 to 3 percent of the total value of contracts agencywide, and Huntsville and Houston centers collectively hovered consistently between 50 and 60 percent of the NASA total.³⁸

Spaceflight Revolution

Compared with the megabucks turned over to the spaceflight centers for R&D during this period, Langley's funding was also relatively small. In 1963 the center received less than 2 percent of the total money set aside by NASA for R&D programs. On the other hand, Marshall received almost 30 percent of the total NASA R&D budget. The most Langley ever received in R&D funding was \$124 million in 1966; the least that Marshall received in the same period was 10 times that in 1968.³⁹

The point of going through these numbers is not to show that Langley was being treated unfairly. As a facility devoted primarily to applied basic research in aviation and space, Langley simply was not doing as much procurement as were those NASA centers responsible for designing, building, launching, and operating spacecraft. What the numbers do show is a new technological order brought on by the spaceflight revolution. In examining the numbers we hold up a mirror to the new sociopolitical context of research activities at the former NACA aeronautics laboratory. The mirror reflects NASA's determination to allocate the lion's share of its financial resources to those arms of the agency most directly involved in what the country was intent on achieving through its space program. In the 1960s that was, first, getting astronauts into orbit around the earth; second, per President Kennedy's May 1961 commitment, landing American astronauts on the moon; and third, in the process, refreshing the nation's spirit, reinvigorating its economy, and showing the world just what the U.S. system of democracy and free enterprise could do when the American people put their minds and energies to it. In other words, the intent was to win the space race.

These figures signify more specifically the rather immediate effects that NASA's broader mission had on the lives of the old NACA research laboratories. Unlike the NACA, NASA would be an operational organization, not just a research organization. It would become heavily involved in projects with goals and schedules and it would contract out to American business and industry a great part of its work. As this happened, Langley staff feared that administrators in Washington would no longer see the center as special. With headquarters now running many of its own shows through contracts to industry, a place like Langley could come to be regarded by many at headquarters as just another contributor to the program. Langley was just one more possible center where work could be done, if NASA headquarters chose to locate it there. But headquarters might instead choose the General Electric Company's Command Systems Division; BellComm, Incorporated; the Douglas Aircraft Company; Thompson-Ramo-Wooldridge (TRW); MIT; or some other very capable organization.⁴⁰ Langley was now for the first time in competition with "outsiders," the many laboratories and firms that had been springing up or growing in competency in conjunction with the burgeoning of the "military-industrial complex" after World War II.

The competition was not inherently harmful to Langley. Given the ample budgets brought on by the spaceflight revolution, NASA had more money than it could spend on itself or on its research laboratories. Langley was

simply not accustomed to the competition, and it was not accustomed to relying on others. For more than four decades its organization had been largely self-sufficient. As an internal Langley study on the history of contracting at the NASA center by Sarah and Steve Corneliussen has noted, the laboratory staff had almost always conducted its own research, built its own models and instrumentation and wind tunnels, and handled its own logistical needs, from mowing the grass to operating its two cafeterias. Only occasionally had outsiders been brought in during the NACA period to augment the civil service staff—and “only temporarily at that, just to help out with occasional peaks in the center’s housekeeping workload.”⁴¹

Thus, many former NACA staffers would need time to adjust to the new environment of NASA and to see that the involvement of outsiders in the work of the new space agency would not take anything away from their historic capabilities or their tradition of self-sufficiency, but would instead add to them. “Contracting out” was not substituting the work of others for what the in-house staff had always done. It was augmenting the capabilities of the NASA researchers so that they could accomplish more. The Langley organization would be no less cohesive nor would contracting damage its best qualities; it would only enhance them.⁴² That, at least, was the argument.

Contracting Out

Other than the occasional employment of temporary laborers for odd jobs, Langley had accomplished almost everything it had to do with its own staff. This self-sufficiency worked well during the NACA period because the range of what needed to be done was usually narrow enough for the civil service work force to handle it. If the work load increased significantly, as during World War II, then the solution was to obtain authorization from Congress for additional civil service staffing. The answer was not to hire contractors.

With the quickening pace of the space race and the urgency of NASA’s expanded mission, however, the work load increased so dramatically that civil service staffing authorizations could not keep up. An evolving mismatch between the high work load at the research center and the low level of congressional authorizations for more research staff eventually forced a reluctant Langley into contracting out for much of the work that it always had done and would have preferred to continue doing itself.

At first the research center resisted the trend toward contracting out and was only willing to hand over to outsiders mundane maintenance and administrative jobs, such as delivering the mail, operating the cafeterias, running the center’s credit union, and maintaining some of the warehouses. Procurements for these jobs involved so-called support service contracts, that is, binding legal relationships drawn up so that the time and the services of an outside firm (i.e., the contractor) could be secured to attain a specified in-house objective.⁴³

Spaceflight Revolution

Even for the tasks of routine housekeeping, Langley wanted the best employees. “If we’re going to hire outsiders,” the procurement officers emphasized, “then let’s choose a way of doing so that maximizes their contributions as adjunct members of the team.”⁴⁴ The best way to do this, they found, was to use a “cost-plus-award fee,” a special—and for the government, novel—form of cost-reimbursement contract. In Langley’s opinion, this arrangement had the highest potential for inducing quality in the contractor’s performance because the contractor’s profit—the award fee—rises or falls in direct correspondence to the customer’s (i.e., Langley’s) appraisal of the work. As with straight cost reimbursement, the expense to the government is not preset, but changes over time with the changing circumstances of the work. This process differentiates both cost-reimbursement and cost-plus-award fee contracts from the more typically used “fixed-price” contract, in which the contracting party specifically delineates the job requested and the time allowed for completing it, and the bidder assumes the risk of matching the forecast of the demands of the job to what those demands will in fact turn out to be. However, in Langley’s case of contracting for ongoing support services usually for terms of several years, during which working circumstances would change and jobs would have to be adjusted, the fixed-price approach would not work.⁴⁵

In essence, the cost-plus-award fee was an incentives contract; according to a formal NASA definition, it provided for “a basic fixed fee for performance to a level deemed acceptable, plus an additional award fee, not in excess of a stipulated maximum, for accomplishment of better than the ‘acceptable’ level.”⁴⁶ Its downside was the administrative burden. The amount of the award was linked to the contractor’s performance; thus, on a regular and in some cases almost daily basis, responsible Langley employees had to inspect and evaluate the contractor’s work. A board of senior managers had to appraise the contractor’s performance at agreed-upon intervals and decide the amount of extra money deserved. A much larger and more formal mechanism for handling contractors therefore had to be developed at Langley. One clear indicator of the burden of this added responsibility was the growth in the size of the Langley procurement staff itself. Before NASA replaced the NACA, this staff comprised 25 people. After the changeover, the staff quickly expanded to more than 100 before leveling off at 70 to 80 after the STG left for Houston.⁴⁷

In this fashion, Langley did what it could to bring out the best in its contractors and to make them feel a vital part of the center. This method of contracting was a way of bringing outsiders “in,” of making “them” part of “us.” However, an inherent and potentially serious difficulty existed in carrying out the philosophy of these contracts. Like all other procurements by the U.S. government, these contracts for support services were governed by federal regulations. The regulations clearly allowed, and the then-current federal policy indeed encouraged, the direct involvement of American businesses, industries, and universities at government facilities like

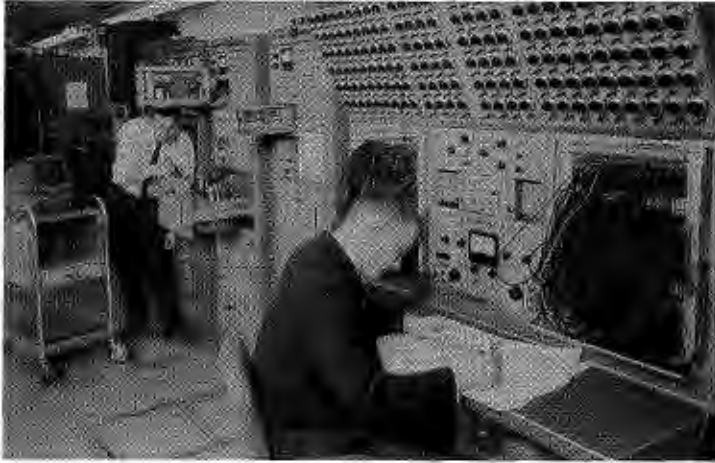

L-59-352

The Langley division most assisted by support-service contractors in the early 1960s was ACD. By mid-decade, contractors were programming the computers and handling the hardware and software support of the mainframe systems, and by 1970, contractors were contributing substantially to the development of computer programs for the guidance, navigation, and control of aircraft and spacecraft.

In this photo, taken in 1959, engineers are at work in Langley's computer complex. Langley's electronic analog brain (seen in photo) with its plugboards and vacuum tubes was replaced in 1965 by mainframe digital computers. The conversion from analog to digital was a major technological development of the spaceflight revolution. Without it the on-board navigation and control needed to achieve the manned lunar landing would have been impossible.

Langley, but the same body of regulations also insisted that the contractors make their contributions at arm's length from civil service management. In other words, the two could not be "in bed together." If civil servants did not maintain this distance, the contractors might become entrenched, their expense charges could get out of hand, and they would essentially have a "license to steal."⁴⁸

Over the years, despite the best intentions of government, Langley staff would have trouble adhering always to the arm's-length requirement. Because Langley wanted to make the contractors feel that they were part of "the family" and in spirit no different from any other employee, staff could hardly treat contractors in the formal, mechanical ways required by the rules. Contracting officials were supposed to follow a labyrinth of procedures and policies to arrive at the letter of the law required by federal procurement. But as civil servants and contractors worked side by side, ate lunch together in the NASA cafeteria, and often became close friends, feelings that Langley should keep to the spirit of the law, as opposed to the letter, prevailed. As a result, the position of the contractors at Langley slowly grew stronger.

Spaceflight Revolution

Starting with the assignment of the Scout booster rocket project to the center in the late 1950s, as Chief Procurement Officer Sherwood Butler recalls, “Langley began to branch out and contract for some highly technical services such as launch support, support of research, and maintenance and calibration of instrumentation.”⁴⁹ Several representatives of the prime contractor, Ling-Temco-Vought (LTV) worked on-site on a daily basis as integral members of the Scout “team.” These contractors included 12 LTV engineers working specifically in the field of instrumentation. Bringing in instrumentation experts amounted to “the first instance of support services contracting in a technical field at Langley.”⁵⁰ With the start of other major projects like Fire and Lunar Orbiter, many contract employees of industrial firms came to work at the center and were such an integral part of the team that they could not be distinguished from the government workers without a glance at their ID badges.

The Brave New World of Projects

In the brave new world brought on by the spaceflight revolution, Langley, as we have seen in its support of the STG, for the first time became heavily involved in project work and the formal management of large-scale endeavors involving hardware development, flight operations, and the administration of contracts. For some of these projects, Langley personally handled the reins of management for NASA headquarters as the designated “lead center.” In the early 1960s such projects included Scout, which began in 1960 for the development of NASA’s first launch vehicle, a dependable and relatively inexpensive solid-propellant rocket; Radio Attenuation Measurements (RAM), which came to life in 1961 to address the radio blackout that occurred during a spacecraft’s reentry into the atmosphere; Fire, which was started in 1962 to study the effects of reentry heating on Apollo spacecraft materials; Lunar Orbiter, which was initiated in 1963 to take photographic surveys of the moon in preparation for the Apollo manned lunar landings; and the Hypersonic Ramjet Experiment Project, which began in 1964 to explore the feasibility of a hypersonic ramjet engine.

Other NASA organizations took the lead for many other projects, and Langley helped by providing diversified R&D support. Langley contributed in this way to all the manned spaceflight projects, from Project Mercury through Apollo. Langley also participated in “cooperative projects.” These were projects for which NASA headquarters assigned the overall project management to another center but gave Langley the official responsibility for subsidiary projects or for specific project tasks. The earliest example of a cooperative project involving Langley was Project Echo, which was started in 1959 for the development of a passive communications satellite. For Project Echo, NASA assigned the project management not to Langley

but to Goddard; however, Langley was responsible for the development of the Echo balloon, for the container in which the balloon was carried into space, and for the balloon's in-space inflation system. Beyond that, Langley was also responsible for managing two flight projects in support of Echo, Projects Shotput and Big Shot, which were designed to test Echo designs under suborbital conditions before the balloons were launched into orbit.

Before exploring the history of NASA Langley's early involvement in project work in subsequent chapters of this book, I want to address a few basic points about projects and about research. A *project* sets out to do something quite specific and to do it in a limited time frame. For example, the goal of the Manhattan Project during World War II was the design and construction of an atomic bomb; the goal of Project Sherwood in the 1950s, as mentioned in the next chapter, was the design and construction of an effective fusion reactor. To fulfill these objectives, the projects' researchers had to move ahead quickly and adhere to strict schedules. They could not afford many detours. The Manhattan Project started in 1941 and concluded in 1945. To achieve the project goal in those four years, a vast array of resources had to be effectively mobilized, organized, and supplied. The enormously complex task of creating the first atom bomb would not have been successful if the U.S. government and its wartime military establishment had not given high priority to completing such a "crash effort." With a far lower priority and with more intractable problems to solve, Project Sherwood staff never did achieve the project's final goal.⁵¹

In its bare essentials, a NASA project was no different from the two projects discussed above. According to a formal NASA definition in the early 1960s, a project was "an undertaking with a scheduled beginning and end," which involved "the design, development, and demonstration of major advanced hardware items such as launch vehicles or space vehicles." The purpose of a NASA project was to support the activities of a *program*. NASA defined a program as "a related series of undertakings which continue over a period of time and which are designed to accomplish a broad scientific or technical goal in the NASA Long-Range Plan."⁵² Typically, the time span of a NASA project was two to three years. Two examples of the agency's "broad scientific and technical goals" from the early 1960s were manned spaceflight (spearheaded by Project Mercury) and the exploration of the moon and the planets (supported early on by the Ranger and Surveyor projects). After President Kennedy's speech in May 1961, NASA's most important goal became a manned lunar landing that was achievable by the end of the decade. That goal was so primary that Apollo, the project, quickly became Apollo, the program. It so dominated NASA's efforts that the moon landing became virtually coextensive with the mission of the entire space agency.⁵³

In contrast to projects with their definite beginnings and ends and specific goals, research is by nature more open-ended and unpredictable. To obtain significant results from research, even from the more practical engineering

Spaceflight Revolution

kind carried out at Langley during its NACA period, risks must be taken. Researchers must venture down long and winding roads that might lead nowhere, ask questions that might turn out to be unanswerable, and spend money on experimental equipment to conduct demonstrations that might never work.

In other words, the environment for research has to be flexible. Needless to say, so too does the researcher and, perhaps especially so, the research manager. For a technical culture to be understanding and supportive of research, it must be forgiving of failure and the apparent lack of progress. On the other hand, as a 1979 NASA study of the R&D process declares, "Projects often provide the ultimate reality. [They] are practical demonstrations. New equipment must function well, performance is measured against the previous experience, and success needs to be achieved."⁵⁴ Otherwise, the project is a total failure. The situation is rather black-and-white.

In research, the criteria for success and failure are gray; success needs to be achieved only once in a while. One fundamental breakthrough that can be built upon for many years makes up for dozens of wrong turns and dead ends. A breakthrough may even be accidental or the fortuitous consequence of some meandering. This is rarely the case in a project. When success is a necessity and the timetable is short, nothing can be left to accident or luck; a "fail-safe" system is called for. Constructing such a system requires systematic and detailed planning, rigorous discipline, proof-tested technology, and extremely prudent management and overall leadership—not to mention enough talented and motivated people to work all the overtime required to complete the job on schedule.

During its 41-year-long history as an NACA laboratory, Langley's "ultimate reality" had been firmly rooted in research, not in projects. Generally speaking, Langley valued research more than anything else. The most meritorious thing that a Langley scientist or engineer could do was to write an outstanding research paper that the NACA would publish as a formal technical report. Langley researchers did not design or build airplanes; as government employees, they were not supposed to, or allowed to, do that. What they did was the basic testing that generated the fundamental knowledge that the aircraft industry used to advance the state of the nation's aeronautical art.

The NACA laboratory was, therefore, not a place for pure research; it was a place for applied basic research and for technology development. As such, Langley staff understood and placed great importance on project work. Most NACA research was neither "basic" nor "scientific" in the usual sense of those words; almost every investigation at the center, whether "fundamental" or "developmental," was aimed at a useful aircraft application. What Langley researchers did best was attack the most pressing problems obstructing the immediate progress of American aviation, particularly those vexing the military air services, and aircraft manufacturing and operating industries. This had often meant "fighting fires," bringing diversified R&D

talents to bear on a problem of the moment, and eliminating or solving that problem in as short a time as possible. Doing so was virtually like carrying out a project.

Thus, in the NACA's way of doing research, of developing wind tunnels and other test facilities, and of attacking technical problems, Langley researchers often followed an approach akin to project management. Many people at NACA Langley felt that their best research programs were those run as projects. For instance, the approach the center adopted to building many major new facilities had been very much like project management. Frequently during meetings of employee promotion boards in the 1950s, a member of the senior staff would ask whether the candidate was a "project engineer" or simply a "researcher." By project engineer, they meant someone who could take on all the responsibilities for carrying out a task and meeting a deadline. To do this, the project engineer had to deal with wind-tunnel operators, get work done in the shops, consult with systems engineering and other technical support people, and perhaps even do a little bit of procurement, such as arranging for the purchase of supplies, materials, or some minor piece of equipment.

This kind of management was done on a much smaller scale than would be done for a NASA project, but NACA Langley researchers did have comparable experiences. With the coming of NASA, they only had to learn to do it on a larger scale. From the end of World War II, PARD had been involved with rocket acquisitions and launch operations, and starting in the mid-1950s, Langley was also heavily involved in the large Project WS-110A. (The designation "WS" stood for "Weapons System.") This was a top secret air force project for the development of what became the North American XB-70, an experimental, six-engine, 520,000-pound strategic bomber designed for a speed in excess of Mach 3. (Only two were built before the project was canceled in 1964.)⁵⁵

Experiences such as those in PARD and with WS-110A made the management of a project easier for Langley when the time came. Most people who would be assigned to many of the earliest NASA projects at Langley would come from PARD. Although Langley staff moved into the project work brought on by the spaceflight revolution and the changeover to NASA without too much difficulty, the novelty or the essential differences between conducting project work and doing research should not be underestimated.

PARD had more critics within Langley than did any of the laboratory's other research divisions. From the moment of PARD's establishment as a separate division in 1946 through its reincarnation as the Applied Materials and Physics Division in 1959, researchers in other divisions were always bickering with someone in PARD. Wind-tunnel groups questioned the merits of PARD's wing-flow and rocket-model transonic testing techniques, arguing that they were too costly and often took priority over more basic tunnel programs. Each firing of a PARD rocket model from Wallops Island required that a precious test model be sacrificed; often the models had expensive

Spaceflight Revolution

instruments inside. Among others, John V. Becker, the influential head of the Compressibility Research Division, complained about the “voracious appetite” of the rocket-model advocates, suggesting that many engineers in PARD were more interested in making their rocket models perform with increasing accuracy than in solving research problems. Becker warned that the practice was causing “a major slowdown” in the production of the models and instruments required by his division and by others. In his judgment, what PARD was expecting, and often receiving, from Langley’s model shops and other technical support services was “roughly equivalent to the requirements of perhaps 10 major wind tunnels.”⁵⁶

Although much of the criticism was unfair, these feelings about PARD and about its focused, rather aggressive project-like approach to doing things worried many senior staff members of the 1960s. Becker and others thought that most of the personnel in PARD were “blacksmiths,” hairy-armed, technical musclemen who did things hit or miss, with hammer and tongs, and without much serious forethought. One of Becker’s branch heads, Macon C. Ellis, Jr., remembers that feelings against PARD within the Gas Dynamics Laboratory were so strong that “when we became MPD [the Magnetoplasmadynamics Branch, in 1960], we definitely didn’t want to go into PARD. That was for sure.”⁵⁷

As Langley took on more project work during the 1960s, people strictly involved in research grew increasingly upset. Larry Loftin, Floyd Thompson’s technical assistant and later director of Group 3, remembers with some hard feelings that “anything with the name ‘project’ got first priority in the shops.” Again, this perturbed those research groups involved in wind-tunnel testing. “You couldn’t do wind-tunnel tests without models,” Loftin recalls, “and you couldn’t get your models done without the shops. All a person had to do was mention Mercury or some other project to somebody in the shops, and it got done. Everybody else waited their turn.” Hostility was particularly high regarding Project WS-110A. Any work connected to WS-110A received the highest priority at Langley. Any test model needed for the project immediately was built in the shops, then was pushed to the front of the line for wind-tunnel testing. This situation led a frustrated researcher to try connecting one of his job orders to Project WS-110A so that he could get some of his own work done.⁵⁸

In analyzing the impact of NASA project work on the traditional character of Langley, continuity from the NACA period must not be exaggerated. Researchers like Becker and Ellis drew a line dividing the ways of NASA projects from NACA research and continued to draw it well into the NASA years. John Stack, the billy-goat-gruff of the Langley senior staff, never abandoned the research ideal of the NACA. In his opinion, the most valuable thing that any Langley employee ultimately could contribute was a published research paper that the American aerospace community could use. Without such contributions, a laboratory would amount to no more than an industrial plant.⁵⁹



L-57-5231

In this 1957 photo, aerodynamicists prepare a scale model of the top secret WS-110A for testing in Langley's 7 × 10-Foot High-Speed Tunnel.

Uncharted Territory

No matter what PARC had done that was akin to project work during the NACA period, large-scale projects for spaceflight were totally new. Langley was inexperienced in many details of project management, in procurement, and in matters concerning the administration of the space agency's expanded R&D and mission activities.

In putting together its diversified operation, NASA faced a complex task: it had to build an effective organizational structure involving intraagency relationships; it had to devise a rational complex of administrative procedures that took care of both internal and external matters; and it had to find the best ways to procure supplies and services. This last requirement, procurement administration, was especially problematic for a technical organization like Langley because it involved the writing, negotiating, and managing of contracts. This meant extensive dealings, legal and otherwise, with corporations and industrial firms in the profit-motivated private sector of the American economy. Such a complicated affair had never been the case for NACA research.

In the early days of the space agency, NASA headquarters realized that most of its executive personnel, especially those running the field centers, were "excellent technical people" who "lacked experience" in managing large

Spaceflight Revolution

projects. Two outside studies sponsored by NASA in mid-1960, one by an advisory committee on NASA organization chaired by University of Chicago President Lawrence Kimpton and the other done under contract by the Washington management consulting firm of McKinsey & Co., found that NASA's executive class needed beefing up. With Administrator Glennan enthusiastically in support of this finding, NASA immediately began a formal program to train project managers. It hired a contractor, Harbridge House, to develop and lead a series of two-week training courses in project management. The first of these courses convened in Williamsburg, Virginia, not more than 25 miles from Langley, in December 1960. Employees from all the NASA installations attended. Langley sent several people—not all of them picked for their potential as project managers. Some general administrative staff also attended the seminars, as did a handful of senior managers like Larry Loftin and Gene Draley. Top NASA officials and managers of industry addressed the participants, while specialists from Harbridge House took groups through case studies “from actual, but camouflaged, R&D problems” faced by NASA and the DOD. Essentially, what everyone was supposed to glean from the training, and for the most part did, was a heightened concern for certain basic management principles and theories.⁶⁰

What NASA hoped to achieve through this training course was “a measure of uniformity” in the management of its diverse projects agencywide. NASA did not want more centralized control over the projects; this had already been tried to some extent in the first two years of NASA's operation and had resulted in an impossibly heavy work load at NASA headquarters.⁶¹ NASA wanted to move toward a more decentralized system in which one field installation would have virtually complete management control over the execution of an entire project; the need for *interinstallation* coordination would be at a minimum; and NASA headquarters could stay out of the *intraproject* coordination and instead could concentrate on *interproject* coordination, which included “the review and approval of projects in the light of overall objectives, schedules, and costs of the entire agency.” All three points were underscored in the October 1960 final report of the McKinsey & Co. study of the NASA organization. In fact, the firm's advocacy of a training course in project management stemmed directly from the conclusions of its specialists about the advantages of a decentralized system. Such a system could work, the report said in emphatic terms, only if each NASA center trained 10 or 20 people in this kind of management.⁶²

NASA would need three years to create the decentralized system called for in the McKinsey report. With the NASA reorganization of October 1963 asked for by Administrator Webb, the system finally was firmly put into place. From that point on, as Arnold S. Levine explains in his 1982 analysis, *Managing NASA in the Apollo Era*, NASA leadership stressed that “project management was the responsibility of the centers.” For all flight projects, “there was to be one lead center, regardless of how many installations

actually participated.”* To take the lead, “a particular center had to [have] (or was assumed to have) the capacity to manage large development contracts, the skills to integrate the subsystems of a project parceled out among two or three different centers, and the ability to draw on the resources of the centers instead of needlessly duplicating them.”⁶³ Those in charge of a project at a lead center would report their business, in a direct and official line of communication, to the head of the appropriate program office at NASA headquarters, for example, to the head of the OART. Senior staff in these program offices then supervised and counseled the work of the project managers in the field as they saw fit.⁶⁴

Ironically, where this shift in NASA project management policy seems to have led by 1963 was back to the NACA concept of giving the field centers the responsibility for technical decisions. Of course, the overall political and cultural context in which those decisions were made was far different from the one in which Langley had operated as an NACA aeronautics laboratory. The NACA was not involved with contractors and all the snarly legalities and procedures that necessarily came with them. In the narrower context of the NACA, technical decisions were not nearly as visible or important to the American public as they would be in the high-profile space program. If an NACA decision had been wrong, the result might have been tragic—if, for example, the aircraft industry or military air services had applied a mistaken NACA research finding in a new airplane design. But the overall context for NACA research was such that major mistakes were almost impossible to make. In normal periods, researchers could usually take all the time necessary to be scrupulously careful and certain of their findings. Even during the rush to support the Allied air forces in World War II, which involved “cleanup” of existing aircraft designs as well as fundamental research and development, researchers had time to be systematic.⁶⁵ Furthermore, the NACA’s clients never applied aerodynamic test results indiscriminately. All sorts of institutional checks and balances would be exercised to confirm the veracity of the government’s research data before using it. In comparison, the context for NASA projects involved a much higher degree of institutional risk. As we have already noted about projects, “success *needs* to be achieved” and in a limited amount of time. The successes of the space race projects would eventually cost NASA and Langley in ways their researchers could not have calculated in the early 1960s. In research, success had always been broadly defined and its price not so dear, but Langley would learn quickly just how exacting a space project could be.

* This was not true for Apollo, which was so big and so important that NASA divvied up the work among lead centers: the spacecraft development to Houston, the launch vehicle development to Marshall, and the tracking system to Goddard.

5

The “Mad Scientists” of MPD

What about this plasma physics? Will it ever amount to anything?

—Dr. Hugh L. Dryden, NASA
deputy administrator, to
Macon C. Ellis, Jr., head of
Langley's Magnetoplasmdynamics Branch

While the Hydrodynamics Division sank at Langley, a few new research fields bobbed to the surface to become potent forces in the intellectual life of the laboratory. Most notable of these was magnetoplasmdynamics (MPD)—a genuine product of the space age and an esoteric field of scientific research for an engineering- and applications-oriented place like Langley. If any “mad scientists” were working at Langley in the 1960s, they were the plasma physicists, nuclear fusion enthusiasts, and space-phenomena researchers found in the intense and, for a while, rather glamorous little group investigating MPD. No group of researchers in NASA moved farther away from classical aerodynamics or from the NACA's traditional focus on the problems of airplanes winging their way through the clouds than those involved with MPD.

The ABCs of MPD

The field of MPD concerned the effects of magnetic and electric fields on the motions of plasmas. A plasma, as simply defined at the time, consists of an ionized high-temperature gas. For those readers who have forgotten their high school chemistry, a gas consists of atoms and molecules that are virtually unrestricted by intermolecular forces, thus allowing the molecules to occupy any space within an enclosure. In other words, the atoms and

PRECEDING PAGE BLANK NOT FILMED

121

PAGE 120 INTENTIONALLY BLANK

Spaceflight Revolution

molecules are continually moving around and colliding with one another. When a sufficiently violent collision between two atoms occurs, a negatively charged subatomic particle known as an electron is knocked out of its orbit, thus resulting in a “free electron” (an electron that is not bound to an atom). Sometimes in the collision, an ion (a positively charged particle bound to the electron) is knocked free as well. At the instant these particles are released, the gas is said to be “ionized” and is called a plasma.

Considered as a whole, a plasma is electrically neutral, composed as it is of an approximately equal number of positively and negatively charged particles plus a variable fraction of neutral atoms. A plasma, however, by virtue of its charged particles, is nonetheless a conductor of electricity. Thus, as is true for any electrical conductor, the motion of a plasma can be greatly influenced, and perhaps even controlled, by electromagnetic forces.¹

By the late 1940s, the study of the motion of ionized gases in the presence of magnetic fields had become a major international focus for scientific research. The new field, which was really a subfield of the large, complicated, and still emerging discipline of “plasma physics,” was known by many names: “magnetohydrodynamics,” “hydromagnetics,” “magneto-aerodynamics,” “magnetogasdynamics,” and “fluid electrodynamics.”* Generally speaking, however, the name “magnetohydrodynamics,” or MHD, won out.²

But the name did not prevail at NACA Langley. There, in the years before the establishment of NASA, a coterie of aerodynamic researchers involved in plasma studies conducted in the center’s Gas Dynamics Laboratory, thought that the name magnetohydrodynamics was not appropriate. The interested researchers were not concerned with *water* but rather with hot gases or plasmas, so they coined the term “magnetoplasmadynamics.” Outside of NASA, however, magnetohydrodynamics remained the standard term.

The Solar Wind Hits Home

Most work on plasmas before World War II pertained to the dynamics of upper atmosphere magnetic storms and to the phenomenon of radiant auroral displays similar to the aurora borealis or “northern lights.” These studies, undertaken most notably by a British group interested in solar and terrestrial relationships led by astrophysicist Sydney Chapman (1888–1970), involved questions about what fueled the sun and the stars and about how the ionized gases brought about by ultraviolet radiation behaved in

* Preference for one name over the others depended on whether the scientists involved felt that the electrically active medium that they were studying should properly be regarded as a continuum or, more accurately, as comprising discrete individual particles. The astrophysicists preferred the name “hydromagnetics”; the aerodynamicists opted for “magneto-aerodynamics.”

interstellar space. In the 1920s, Chapman postulated that several geocosmic phenomena could be explained by the "differential action" of the earth's magnetic field on protons and electrons emanating from the sun. Solar activity, in Chapman's soon-to-be dominant view, influenced the terrestrial magnetic field, aurorae, the conduct of atmospheric electricity, and the earth's weather patterns.³

In 1942, Swedish astrophysicist Hannes Alfvén (an eventual winner of the Nobel Prize) advanced an MHD theory of the so-called solar cycle, the periodic round of disturbances in the sun's behavior as seen in the fluctuation in the number and the area of sunspots and in the form and shape of the sun's corona. Some 10 years later, in the early 1950s, Alfvén proposed an even more provocative theory. He postulated that the planets had been formed by an MHD process by which ionized gases became trapped electromagnetically and pulled inward by the sun's gravitational force, thus leaving them at certain distances from the sun. The only way to fathom the process, Alfvén argued, was to work further with MHD equations.⁴

Thus, in large measure, the interest in MHD began with the modern astrophysicists. From the 1920s on, many of their most essential questions concerned MHD: What mechanisms are involved in galaxy formation? What is the nature of the magnetic fields of the sun and the other stars? How does the internal energy in hot stars convert into the kinetic energy of gaseous clouds in interstellar space? How do stars form from gas clouds? What is the origin of cosmic rays, the Solar System, the universe? The key to understanding the cosmos lay in the fathoming of MHD principles.

Revolutionary discoveries about the space environment made with the first space probes strengthened the belief in MHD's importance. On 1 May 1958, five months to the day before the NACA transition to NASA, American astrophysicist James Van Allen announced his discovery of a region of intense radiation surrounding the earth at high altitude. Data from Geiger counters aboard the first three Explorer spacecraft, the first successful American satellites, confirmed a theory that Van Allen had been working on for some time. This theory suggested that the earth's magnetic field trapped charged subatomic particles within certain regions. Experiments aboard subsequent exploratory rockets and spacecraft indicated with a high degree of certainty that more than one radiation belt in fact enveloped the earth. The intensity of the belts varied with their distance from the earth. The zone of the most intense radiation began at an altitude of approximately 1000 kilometers (621.37 miles).⁵

The discovery of what immediately came to be known as the Van Allen radiation belts inspired a wide range of fundamental new investigations. Within months, scientists around the world realized that surrounding the earth was a vitally important magnetic region of still unknown character, shape, and dimension where ionized gases—plasmas—exerted a strong force. They dubbed this mysterious region "the magnetosphere." In the exciting but highly speculative early days of magnetospheric physics, this region was

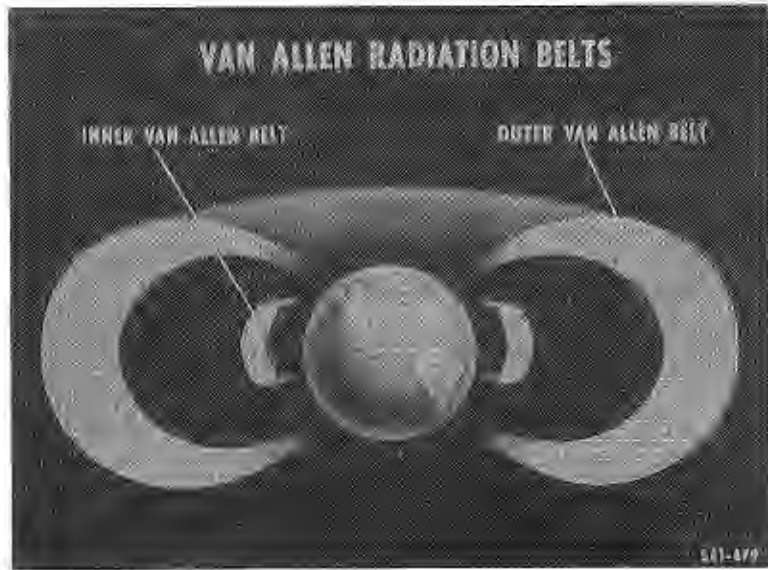

L-61-6169

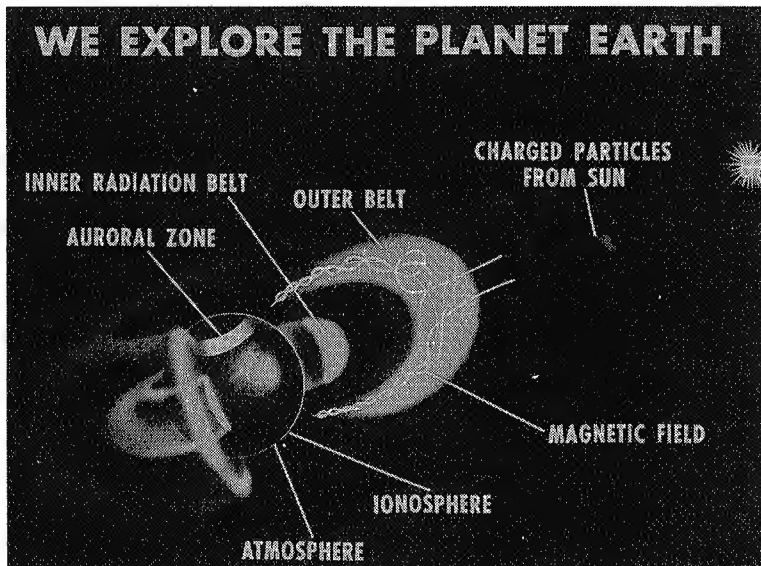

L-61-6163

Langley's MPD researchers used these schematic drawings to illustrate the main features of earth's bordering region with outer space.

alternately described as “a high region of the earth’s atmosphere” or as a “low or bordering region of space.”⁶

Another important discovery of the space age fed the new science of magnetospheric physics: the notion of “the solar wind.” This theory was first expressed by Eugene N. Parker of the University of Chicago in 1958 and later confirmed by measurements taken from Soviet Lunik spacecraft in 1959–1960 and from *Explorer 10* in 1961. Parker suggested that the sun’s corona, or outer visible envelope, was expanding continuously, causing streams of ionized gases to flow radially outward from the sun through interplanetary space. (The sun is, after all, a big ball of plasma.) The intensity of these plasma streams varied greatly relative to solar activity, especially solar flares. The force of these streams, or solar wind, impinging upon the earth’s magnetic field created the familiar magnetic storms.⁷ By 1960 scientists possessed evidence that a plasma wind did blow continuously from the sun, and the wind clearly displayed dynamic magnetic phenomena.

The field of study that the Langley researchers had come to call MPD was growing quickly in esteem and importance, not only in the United States but also around the world. Newly conceived experiments with magnetically compressed plasmas provided scientists with an opportunity to generate and study a small sample of the solar corona in the laboratory. Scientists gathered basic data on subatomic behavior at temperatures for which no such information existed before. A major and extraordinarily exciting new age of modern physics was dawning. Scientists saw fascinating new research opportunities, and they dreamed of fantastic technological applications. Unfortunately, very few of their dreams would be realized. But in the early 1960s, that was something impossible to know.

What Langley researchers, especially those involved in gas dynamics and other hypersonic investigations, did know in the late 1950s was that the time for a major change had arrived. “The space age told us to move away [from] classical aerodynamics into more modern things,” remembers Macon C. “Mike” Ellis, the man who would head Langley’s formal MPD effort, “and, as quickly as we could, we did.”⁸ In handwritten notes made at an internal meeting of his Gas Dynamics Branch held on 18 June 1958—during the same period that plans for NASA’s initial organization were being formulated in Washington—Ellis wrote, “Either we make a *big* change now or [we] try to make more significant contributions in aerodynamics.” MPD is

a field we are already in and should push hard. . . . We should go all out to get qualified physics instructors. . . . We should have seminars on “space-type” and reentry subjects. . . . We must *work* and *plan* toward ultimate “conversion” of our work when aerodynamics becomes secondary. . . . We must go big into the new environment of space.⁹

Spaceflight Revolution

Now was the time for Langley researchers to assume leadership roles in the emerging space disciplines and vigorously seek major technological applications.

The MPD Branch

Through the late 1950s, nothing had been done formally at Langley to focus the efforts of those involved in the study of MPD-related subjects. Many people at the laboratory, some of them senior engineers and research managers, did not know what MPD was or did not understand what all the fuss was about. Furthermore, nearly all of the people concerned with MPD were members of the Gas Dynamics Laboratory, so they were already grouped together and interacting regularly. Thus, for several months, even after the new space agency was established, no Langley leaders saw a need to create a new organization just for the MPD enthusiasts.

But interest in the new field kept growing. The idea that flows could get so hot that the constituents of the air would actually break down and become treatable by applying magnetic forces was extremely exciting. If airflows could be “treated” electromagnetically, they might even be *controlled*. That was every aerodynamicist’s dream. MPD offered a sort of aerodynamic alchemy, a magical way of turning lead into gold, rough turbulent flow into smooth laminar flow, dangerous reentry conditions into pacific ones. With these glorious possibilities, MPD fostered great technological enthusiasm and attracted many able researchers who hoped to find solutions to some fascinating and very complex problems.

The study of MPD became increasingly glamorous in the late 1950s, so much so that Langley management soon understood that it should advertise the progress that Langley researchers were making in MPD studies. At each of the former NACA laboratories—Lewis, Ames, and Langley—research in MPD grew in earnest in the months just before the metamorphosis of the NACA into NASA and thereafter gained momentum.¹⁰ At the first NASA inspection in October 1959, MPD was a featured attraction. In the printed inspection program, MPD merited one of the 13 subtitled sections. Visitors on the inspection tour stopped at a special MPD exhibit. At that stop, a Langley MPD specialist stood in front of a graphic panorama of the universe and introduced his subject by saying that “the space environment is filled with manifestations of this new science.”¹¹

Above all other members of Langley’s staff, Floyd Thompson, still officially the associate director, became most enthralled with the glamour of MPD. As Mike Ellis remembers, “Thompson was tremendously supportive of our effort.” One of the best measures of Thompson’s enthusiasm was his request that the MPD staff be “on tap” as the special attraction for major events. He “always put us on stage at the NASA inspections and when various groups of scientists came through the laboratory,” Ellis

recalls. Thompson appreciated that work in this exciting new field of science could enhance the reputation of his aeronautics laboratory.¹² In May 1960, the same month he took over officially from Henry Reid as the Langley director, Thompson established a Magnetoplasmadynamics Branch of the Aero-Physics Division. From its beginning, MPD was one of Thompson's pet projects.

The Aero-Physics Division was the natural home for Langley's MPD effort. This division was led by hypersonics specialist John V. Becker, an NACA veteran whose employment at Langley dated back to 1936 and who by the mid-1950s had become deeply involved in work related to hypersonic gliders and winged reentry vehicles. A research-minded engineer, Becker was a strong and confident division chief (he had been one since the mid-1940s, passing up several opportunities to move up to posts in senior management). He was comfortable having a research effort as esoteric and as sophisticated as MPD based in his division. Scientifically, he was quite sharp and was more than capable of appreciating the complexities of this new field of research as well as its promise for making major contributions to the space program. Through the 10-year span of the MPD Branch (1960–1970), Becker not only tolerated the many MPD enthusiasts in his division but also almost always supported their ideas.

The first and only person to be in charge of Langley's MPD Branch was Mike Ellis, an NACA veteran who was 42 years old when the branch was organized. Ellis had come to work at Langley in 1939, and over the course of his career at the laboratory, he had been involved in pioneering work on the aerodynamics of jet engines, ramjets, and supersonic inlets and nozzles. Fittingly, Ellis had worked for Eastman Jacobs and with Arthur Kantrowitz in the early 1940s, and he had heard firsthand accounts of his former colleagues' attempt to design a fusion reactor in the spring of 1938. By the late 1950s, Ellis was one of Langley's most outspoken believers in MPD's promise of technological benefits. Ellis encouraged Floyd Thompson's enthusiasm for MPD and persuaded Langley's senior staff of mostly engineers that MPD was a field of research vital to the future of NASA. When the time came to pick someone to head the new branch, Ellis was unquestionably the person for the job.

Ellis was no extraordinary "scientific brain." As an aeronautical engineer, his talents were quite respectable, but he possessed no special competency in the physics of fluids beyond his experience in aerodynamics or gas dynamics. He was always the first to admit that the complexities of plasma physics and MPD were such that "there was no way" that he personally could conduct basic MPD research. That challenge he would leave to minds more suited for it. But Ellis could bring the MPD researchers together as a unit, serve as their strong external advocate, shield them from front-office pressures, and make sure that they received the support they needed to carry out their work. "I just tried to keep my head above water," Ellis explains, "and keep

Spaceflight Revolution

In the 1960s, John V. Becker (left) headed the Aero-Physics Division, which was home to many of the center's highest speed, and most radical, research facilities. These included supersonic and hypersonic wind tunnels, arc-jets, and shock tubes covering a speed range from Mach 1.5 to Mach 20. Some of these facilities, such as the \$6.5 million Continuous-Flow Hypersonic Tunnel (below), were the forebearers of the strange apparatuses of the MPD Branch.



L-61-4064

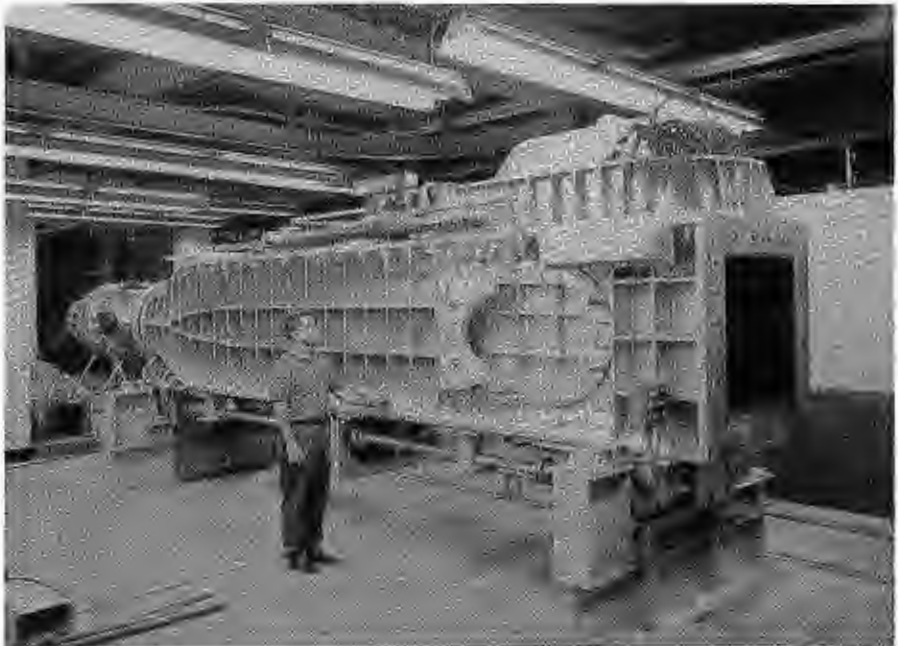

L-61-6268

The “Mad Scientists” of MPD



Engineer Macon C. “Mike” Ellis was an early believer in the promise of MPD.

L-62-8043

these ‘mad scientists’ from going off on too many tangents, or going mad myself.”¹³

The MPD Branch never became a large outfit. By the end of 1962, it had less than 50 total staff members: 27 professionals, 10 mechanics, 4 computers (mathematicians who helped to process and plot numerical data), and 6 secretaries. This staff was divided into four teams or sections. Plasma Applications, headed by Paul W. Huber, was the largest section, with 8 professionals. Space Physics, led by British physicist David Adamson, was the smallest with 3. Robert Hess’s Plasma Physics Section had 7 professionals, and George P. Wood’s Magnetohydrodynamics Section had 5. These sections (and their section heads) remained in place until the dissolution of the MPD Branch in 1970.

In addition to being small, MPD was self-contained. Whereas most of the research done in the center’s branches regularly spilled over into other functioning units, most MPD work was done within the MPD Branch. A small amount of related research was done in the Flight Research Division and Full-Scale Research Division; however, most of this work concerned the development of microwave and spectroscopic diagnostic techniques. All told, the MPD work conducted outside the MPD Branch never involved more than about five researchers.

In terms of organizational genealogy, the MPD Branch grew from a narrow stem. With the exception of Adamson, and a trio of his colleagues from a space physics group in the Theoretical Mechanics Division, all the original members of the MPD Branch came from the Gas Dynamics Laboratory. The guru of MPD studies in this lab was Adolf Busemann. Throughout

Spaceflight Revolution

the 1950s, Busemann had inspired engineers with his provocative theories and experimental ideas. At Langley on 22–23 September 1958, the German aerodynamicist even chaired an important interlaboratory meeting on MHD. Ninety-three people attended the meeting, which featured 6 speakers from Ames, 4 from Lewis, and 11 from Langley and was organized into three sessions—plasma acceleration, arc-jets, and ion beams. Busemann gave a 20-minute talk on the theory of alternating-current (AC) plasma acceleration. This two-day scientific meeting, held one week before the changeover to NASA, was the precursor of much larger conferences on MPD sponsored by NASA on almost an annual basis into the mid-1960s.¹⁴

Among the scientists working in MPD at Langley were several Germans. Like many other scientific institutions around the country, Langley had received a handful of German scientists who were part of Operation Paperclip, the U.S. Army intelligence operation that brought captured German rocket scientists and engineers to work for the U.S. government at the end of World War II. Busemann and two other outstanding researchers, Karlheinz Thom and Goetz K. H. Oertel, came to Langley through Paperclip. Both Thom and Oertel moved from Gas Dynamics to George Wood's MHD Section of the new MPD Branch. Both men stayed at Langley for several years before eventually taking posts at NASA headquarters.

At least 10 German scientists came to Langley as part of a postdoctoral program funded by NASA but sponsored by the National Academy of Sciences. This program, which was totally divorced from the normal civil service procurement system, enabled NASA to obtain talented people as Resident Research Associates (RRAs) without going through the normal hiring procedures of the civil service and without regard for NASA's personnel ceilings. In 1968, for instance, 6 of the 39 professionals in the MPD Branch were RRAs.¹⁵

Langley's MPD group attracted other foreign scientists. These included Dr. Marc Feix, a French nuclear scientist who spent a few years at Langley in the mid-1960s and did some outstanding theoretical work. Feix was nominally assigned to Hess's Plasma Physics Section, but he actually worked with various people throughout the branch, especially with the Space Physics Section under David Adamson. Adamson had first worked at Langley at the end of World War II on an exchange program from the Royal Aircraft Establishment in Farnborough England.¹⁶ After the exchange, Adamson went home to England, but soon returned to Langley.*

In the 1960s, the researchers of the MPD Branch were the most highly educated group of people at Langley. The MPD Branch enjoyed the

* In 1958, in support of Assistant Director Eugene Draley's initiative to advertise Langley's (then largely alleged) expertise in space science, Adamson composed an excellent paper on the principles of gravity. According to some experts, this paper, which NASA published, turned out to be "one of the best papers ever written" on the subject, as well as one of the most quoted. (Ellis audiotape, Nov. 1991, author's transcript, p. 18.)

The "Mad Scientists" of MPD



L-62-8122



L-65-1110

Paul W. Huber (left), head of MPD's largest section, Plasma Applications. In the mid-1960s, French nuclear scientist Dr. Marc Feix (right) floated from section to section within the MPD Branch, helping researchers solve theoretical problems basic to plasma physics.

academic mystique of having by far the highest percentage of advanced degree holders. At one point MPD had eight employees with earned doctorates, seven others at the Ph.D. dissertation stage, and virtually all of its younger people working toward advanced degrees.*

Compared with other research groups at Langley, the MPD enthusiasts participated in more international scientific conferences; had more contacts with consultants, important scientific committees, and advisory groups outside Langley; monitored more research contracts; and received more distinguished visitors. Senior management asked MPD researchers to occupy center stage during NASA inspections and to escort distinguished guests into their Frankensteinian laboratories, which were filled with plasma accelerators, MPD-arc fusion reactors, powerful electrical supplies, spectrometers, microwave diagnostic instruments, and other bizarre apparatuses. Even to other engineers, this equipment was strange and unidentifiable. Understandably, their peers considered the Ph.D.'s and other 'mad scientists' of MPD a prestigious group.¹⁷

* Ironically, neither Wood, head of the MHD Section, nor Hess, head of the Plasma Physics Section, held a Ph.D. Wood completed all the course work toward a doctorate in the early 1930s, but because of the Great Depression he had to go to work before receiving his degree; Hess graduated from the Vienna Institute of Technology and had taken graduate courses in fluid mechanics and thermodynamics at MIT in the late 1930s, but he also did not possess an advanced degree.

Spaceflight Revolution

But the prestige could last only if Langley's MPD work proved deserving; the proof lay in conducting outstanding research programs and producing meaningful results. When the MPD Branch was formed in 1960, Langley researchers saw three particularly promising applications for MPD research. First, they hoped to accelerate gases to very high speeds to study and solve the reentry problems of intercontinental ballistic missiles (ICBMs), spacecraft, and transatmospheric or aerospace vehicles such as the North American X-15 rocket plane and the U.S. Air Force proposed X-20 Dyna-Soar boost-glider. The potential for these applications explains in part Langley's commitment to the small-scale but significant program of research and development of various plasma accelerators.

Second, the MPD experts at Langley hoped to develop prospective applications of MPD for spacecraft propulsion and power generation systems. They were confident that electric or ion rockets would be the space propulsion system of the future. If humankind was to go to Mars or some other planet in a reasonable travel time, such radical sorts of propulsion systems would be required. Therefore, the centers for NASA's major propulsion efforts (especially Lewis in Cleveland and Marshall in Huntsville) must begin studying the ion and plasma devices that might someday offer to rocket technology the extraordinarily high specific impulses required for such far-away missions. Most definitely, the design and operation of these rockets would require the use of MPD principles.¹⁸

Third, Langley's MPD specialists realized that if controlled thermonuclear fusion was to become a practical source for the volume generation of electricity, much more about the subject would have to be learned. Beginning in the late 1950s, the Atomic Energy Commission had begun conducting MPD research with the production of electric power in mind. Branch Head Mike Ellis also believed that "the eventual energy source will be thermonuclear fusion" and that "the development of this energy source most likely will depend upon fundamental discoveries in the field of magnetoplasmadynamics."¹⁹

The promise of the field was indeed wonderful. But the promise of wonderful or even revolutionary findings and applications could sustain the new MPD group at Langley for only so long. At some point, MPD studies had to produce. The reality was, as John Becker later put it, "Of all the efforts we had, it was the most sophisticated and probably the least likely to succeed. We shouldn't have expected as much from it as we did."²⁰

Out of the Tunnel

Concern for the problems that the ICBM encountered during reentry flight prompted Langley researchers to begin the study of MPD in 1958. The physics of the unique conditions of the hot ionized flow around the missile's nose during reentry demanded special attention. Space vehicles

when reentering the atmosphere quickly became covered with electrically charged particles. These particles formed a "plasma sheath" behind the bow shock. Researchers hoped that an application of electric and/or magnetic fields to the plasma sheath could affect the airflow in desirable ways; for example, it could reduce the heat transfer to the nose. The most direct effect of the plasma sheath, however, was that radio transmission from the vehicle during reentry was not possible for obtainable radio frequencies. The plasma caused a period of "radio blackout."

To solve these problems, researchers at Langley had to simulate reentry conditions in the laboratory. This would require some new and unusual research equipment; conventional wind tunnels would not do the job. Small hypersonic tunnels, made possible by the development of high-temperature heat exchangers and high-speed nozzles and operated on an intermittent basis for flow durations of only seconds to no more than a minute, permitted studies of *some* forces during reentry, but not *all* and not some of the most important.

Several university, industrial, and government research groups had made significant advances in the acceleration of hot ionized gases by the late 1950s. Some of these advances involved the arc-jet, a novel apparatus for aerodynamic testing that could heat a test gas (usually nitrogen, helium, or air) to temperatures as high as 20,000° Fahrenheit (F). In essence, the arc-jet was a primitive electric rocket engine.²¹ In May 1957, five months before Sputnik, NACA Langley began operating a pilot model of its first experimental arc-jet. Installed in Room 118 of the center's Gas Dynamics Laboratory, it was an "Electro-Magnetic Hypersonic Accelerator Pilot Model Including Arc-Jet Ion Source," with a test section size of a minute 7 × 7 millimeters and gas temperatures ranging between 10,000° and 12,000°F.²²

Fundamentally, the arc-jet was just another hot-gas wind tunnel, which heated the gas electrically (typically using 100,000 kilowatts) to high temperatures in a low-velocity settling chamber, and then expanded it quickly through a tiny nozzle to supersonic velocities. No translational electric or magnetic forces acted on the gas in this conventional arc-jet. The gas was simply being heated by an electrical discharge. Most of the charged particles in this high-temperature discharge recombined in the cooling process that occurred during expansion.

In 1962, Langley tried a slightly different but companion arc-jet facility known as the hotshot tunnel. This hybrid, invented in the mid-1950s by engineers at the U.S. Air Force's Arnold Engineering Development Center in Tullahoma, Tennessee, combined the basic features of an arc-jet with those of a new type of wind tunnel known as an impulse tunnel. In this tunnel an explosive release of energy created high pressures and temperatures in the test gas.²³ In practice Langley's hotshot mostly missed the mark. To generate the very high heat, its operators had to resort to exploding a piece of copper through the tunnel circuit, thus the name "hotshot." The material

Spaceflight Revolution

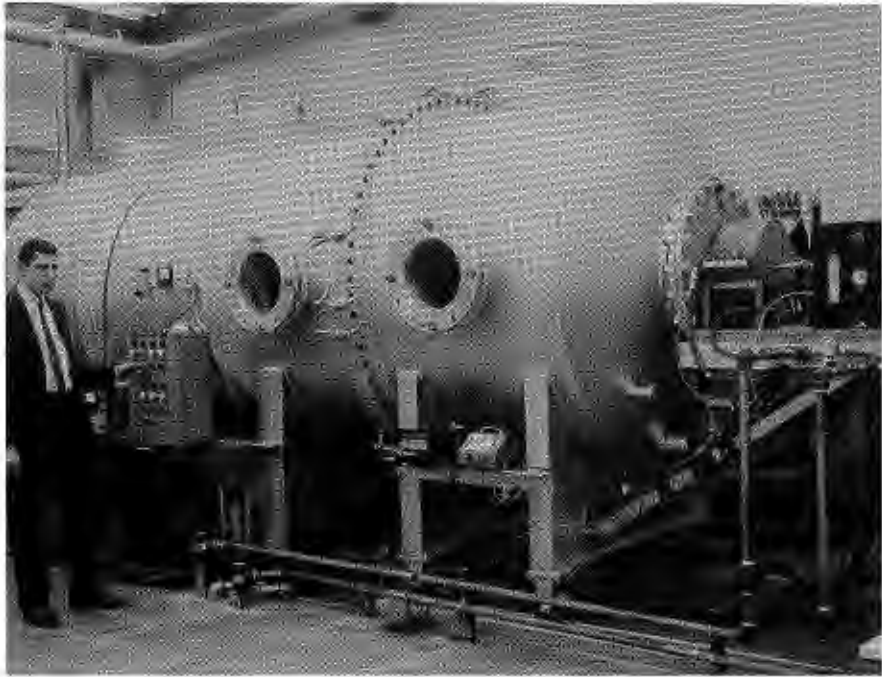

L-64-11,179

Research physicist Philip Brockman pushes the button to start the MPD-arc plasma accelerator in December 1964. The test chamber for this facility was part of a larger high-flow, low-vacuum space simulation apparatus housed within the MPD Branch.

that then made its way through the test section was a mixture of hot air and vaporized copper, a very unsatisfactory medium for aerodynamic testing. The facility remained active into the 1970s, but the amount of useful work accomplished in it was quite limited.

Another facility for reentry testing that was developed in the late 1950s was the shock tube. Fundamentally, this was an impulse tunnel, distinguished from a hotshot mainly by the way in which energy was added to the test gas. According to a formal definition of the time, a shock tube was “a relatively long tube or pipe in which very brief high-speed gas flows are produced by the sudden release of gas at very high pressure into a low-pressure portion of the tube.” The idea was to generate a normal planar (that is, lying in one plane) shock wave and send it through a gas at a speed 20 to 30 times the speed of sound, [and] thus heating the gas behind the normal shock to an extreme temperature.²⁴

Langley’s first shock tube began operation in the Gas Dynamics Laboratory in late 1951. By the end of the NACA period, three more shock tubes were put to work at the laboratory; they produced temperatures between 10,500° and 15,000°F, attained speeds of Mach 8 to Mach 20, and had

running times of 0.001 to 0.002 seconds.²⁵ Researchers believed that experiments with these devices would yield much knowledge, even though everyone involved with shock-tube work conceded that "it was a very tough area of research." Contending with flows that lasted for only a few thousandths of a second and that required a considerable amount of special instrumentation was "a fantastic problem." How were researchers "to get answers out of something like that?"²⁶ Still, those passionate about high-velocity flows and high-temperature gases at Langley put great faith in the shock tube. The facility was used for much basic research including studies of shock waves generated by atomic bomb blasts.

Through the transition period of 1957 and 1958, researchers at the lab continued to seek new ways to accelerate hot plasmas to the tremendous velocities of reentry flight. In a method devised by Langley MPD enthusiast George Wood, a hot gas was fed into a tube, then the body force of crossed electric and magnetic fields was used to accelerate the gas to the point where a mixture of disassociated, high-enthalpy flow would reproduce the very high Mach numbers of hypersonic flight. At NASA's First Anniversary Inspection in 1959, Langley engineers demonstrated a crude version of Wood's crossed-field plasma accelerator. It produced a flash of light, a loud bang, a startled audience, and a belief in the promise of major new scientific findings.²⁷

Nearly everyone was excited by the potential of plasma accelerators. When John Stack first heard about the facility, he exclaimed, "This is great!" Stack felt that Langley should call the device something grand; he proposed the awe-inspiring name, the "Trans-Satellite-Velocity Wind Tunnel."²⁸

Given the limited performance of Wood's early version of the experimental accelerator, such a pretentious name would have been a poor choice. As part of a guided tour for top officials from NASA headquarters in late 1959, Langley hoped to show off the radically new plasma acceleration device. Almost comically, it did not work. One embarrassed Langley engineer who watched the demonstration remembers, "We all sat around expectantly while Dr. [Adolf] Busemann explained the system. Then Busemann went over and threw the switch." Unfortunately, only "a little stream of red-hot particles sort of 'peed out' the end of this tube. It was a complete washout. Busemann just giggled and said, 'Well, we have a problem.'"²⁹

The concept behind Wood's crossed-field plasma accelerator was sound: it was an application of a 130-year-old theory of electromagnetic force that had been expressed by Ampère in the 1820s. Langley researchers kept fiddling with the pilot model until in 1960 they successfully demonstrated its feasibility. Having done so, they continued research on larger, more powerful versions of the device. One version, the 20-megawatt plasma accelerator, was completed in 1966 at a cost of more than \$1 million. With this facility, the MPD Branch planned to achieve more accurate simulation of the reentry conditions of both manned and unmanned vehicles. Shakedown testing in the accelerator continued until 1969, when political pressures applied by the

Spaceflight Revolution

George P. Wood (right), head of MPD's Magnetohydrodynamics Section, developed Langley's earliest crossed-field plasma accelerator. The accelerator section of the 20-megawatt plasma accelerator facility is shown below. Note the many electrodes for furnishing the high-energy electric field.



L-62-8047

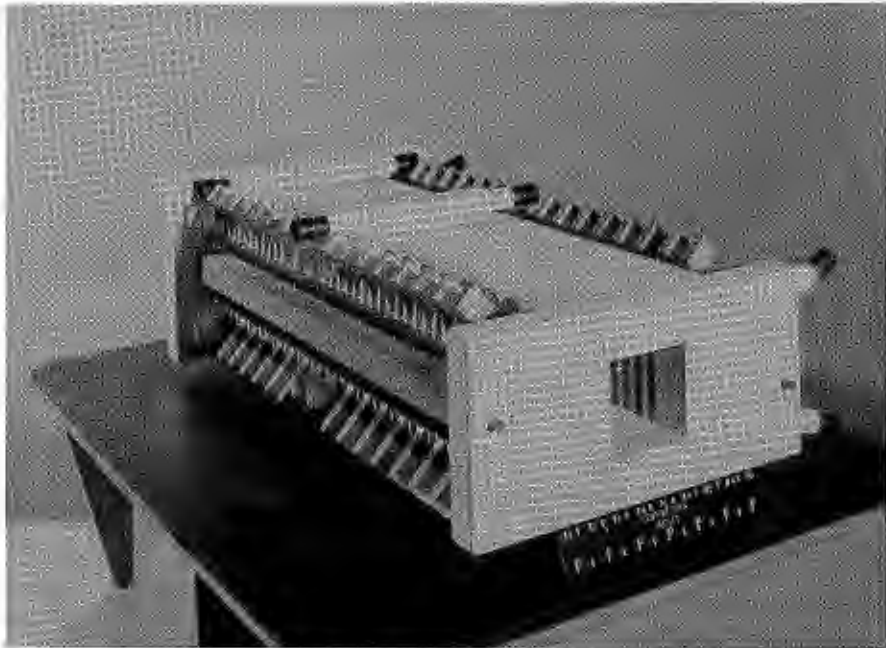

L-66-1913

The "Mad Scientists" of MPD



L-63-3361



L-65-8509

In this April 1963 photo, MPD lab technician Charlie Diggs regulates the flow of a test gas in an early 10-kilowatt test version of Langley's Hall-current plasma accelerator (above); over his left shoulder sits a Polaroid camera for photographing an oscilloscope. In November 1965, an unidentified technician (left) wears goggles to protect his eyes against the intense light in a later coaxial version of a Hall-current plasma accelerator. In the test section, one can see the very bright, high-velocity plume from the MPD arc-jet exhausting into a vacuum tank.

Spaceflight Revolution

Nixon administration forced an abrupt halt to the accelerator's pioneering work. Whether the machine would have ever completely panned out, no one can be sure.

In NASA's report on the last tests made in this device, published in 1971, George Wood and his colleagues pointed out that an exit velocity of 30,176 feet per second had been achieved, which was a remarkable 81 percent of the facility's computed capacity of 37,064 feet per second. According to the NASA report, the crossed-field accelerator "appears to be the largest and highest velocity nonpulsed linear plasma accelerator" to attain "an operable status."³⁰ An experimental facility with this record must be called a success.

While trying to work out the kinks in Wood's crossed-field accelerator design, Langley's MPD experts conceived several other methods for accelerating plasmas. One of these methods, which was not pursued very far, they called "microwave cavity resonance." The major alternative, however, was known as the "linear Hall-current accelerator." This type of plasma accelerator was based on a principle of electrical polarization and current generation laid out by the American physicist Edwin H. Hall in the 1920s and 1930s. The facility used a constant rather than intermittent interaction of currents and magnetic fields across a channel to accelerate a steady flow of plasma.

Beginning in the late 1950s, a small group of Langley researchers led by Robert V. Hess, an applied physicist from Austria who had come to work for the NACA in 1945, began pursuing two major variants of the Hall accelerator: the MPD arc and the so-called linear Hall accelerator. Throughout the 1960s, Hess and his associates refined these versions of the plasma accelerator, thus making extensive experimental and theoretical studies of the physics and overall performance of their devices. Although they successfully demonstrated the efficiency of the MPD arc and linear Hall accelerator and made several important findings relating to the manner in which oscillations and instabilities in plasma could develop into turbulent flows, MPD researchers were never able to simulate reentry conditions or the interaction between the solar wind and the geomagnetosphere, and they would never realize meaningful applications in space propulsion. As was the case with the other MPD experimental facilities mentioned, the linear Hall-current accelerator possessed limitations that Hess and his colleagues could not eradicate. By the late 1960s, Hess and others in MPD shifted the focus of their work with these accelerators to the potential application of gas lasers.³¹

Into the Cyanogen Fire

In the late 1950s, the Langley MPD group found a stopgap method of generating a plasma in the laboratory. This method involved the production of a hot flame fueled by the combustion of cyanogen gas and oxygen.

The "Mad Scientists" of MPD



Robert V. Hess, head of MPD's Plasma Physics Section.

L-62-8120

MPD physicist Bob Hess was an intense researcher and bibliophile. He combed the current technical and scientific literature for ideas that might prove useful to his and his colleagues' work. Proficient in German and French as well as English, he was able to keep abreast of scientific ideas along several fronts. With his desk piled high with papers, Hess ferreted out the best notions, and massaged them for his own creative uses.* In 1957, Hess came across a reference to a new experimental device at the Research Institute of Temple University in Philadelphia. This device produced an extremely hot flame by burning oxygen with cyanogen, a colorless, flammable, and poisonous gas, sometimes formed by heating mercuric cyanide. After reading about the cyanogen flame experiment, Hess hit on an idea for adapting the flame to create a hot plasma for simulating the space reentry environment. By feeding oxygen and cyanogen gas into a combustion chamber and igniting the mix, the researchers at Temple were producing a flame of more than 8000°F. This was one of the hottest flames scientists had ever produced. What would be the result, Hess mused, if a potassium vapor that ionized easily at that temperature was added to the combustion chamber? Would

* For example, in 1945 Hess found an overlooked British translation of German aerodynamicist Dr. Adolf Busemann's seminal 1937 paper on sweptwing theory. Hess found it in the Langley Technical Library, where his future wife, Jane, would someday serve as the head librarian and assist him greatly with his search for references, and he passed it on to colleague Robert T. Jones. This was just prior to Jones's final revision of a confidential NACA paper in which Jones would report his independent discovery of the advantages of wing sweep for supersonic flight.

Spaceflight Revolution

this create a jet of hot gas that reproduced the extremely ionized plasma conditions of missile reentry?

On 17 June 1957, Hess and his boss in the Gas Dynamics Laboratory, Macon C. Ellis, Jr., visited Temple University to discuss the details of producing a cyanogen-oxygen flame and to inquire about the feasibility of adding an easily ionizable alkaline material, potassium or perhaps cesium, to the flame. The key people to whom they spoke were Dr. Aristid V. Grosse, director of the Temple Research Institute, and Charles S. Stokes, who was in charge of the cyanogen flame program. Grosse and Stokes agreed that “the great stability of the combustion products” made them “well suited” for an addition of an ionizer such as potassium; they told the Langley visitors that they themselves had recognized this in one of their early reports, perhaps in the one that Hess had read. However, they had not made quantitative estimates of the electron densities or followed up on the idea in any way. They wondered whether the addition of potassium might not exert a cooling effect that would somewhat diminish the density of electrons. Hess, however, had already made the estimates and knew that the density of the electrons in the seeded cyanogen flame would be sufficiently high (about 10^{16} per cubic centimeter) to compensate for any temperature-reducing reactions.³²

At Langley, Paul Huber with the help of the facilities engineering group quickly designed a cyanogen flame apparatus, and the funding for its construction was approved. By the time the NACA became NASA, the device had been operating for several months. As expected, the first major test program conducted in Langley’s alkali-metal-seeded, cyanogen-oxygen flame explored how flow-field conditions near an ICBM nose prevented the transmission of radio signals back to earth. Researchers in the Gas Dynamics Laboratory working with Joseph Burlock of IRD mounted a transmitting antenna in front of a nozzle that bathed the antenna in the hot cyanogen gas jet. Instruments then measured the rate at which the transmitter lost its signal power.

The early MPD test program demonstrated the feasibility of creating and controlling the highly ionized plasmas representative of the extreme dynamic conditions of spaceflight and reentry. The program also showed that certain simplified theoretical methods could be used to calculate the loss of electronic communication with a vehicle during reentry of a vehicle from space. If plasma conditions around the vehicle could be estimated with reasonable accuracy, researchers then would be able to predict the expected radio power loss. This was critical information for trips in and out of space by guided missiles, aerospace planes, and manned and unmanned spacecraft. Led by the outstanding theoreticians Calvin T. Swift and John S. Evans, who worked in the Plasma Applications Section under Paul Huber, MPD researchers at Langley continued to make significant contributions throughout the 1960s. On the problems of transmitting radio signals to and from reentry vehicles, no group inside or outside of NASA came to speak with more authority.³³

The “Mad Scientists” of MPD

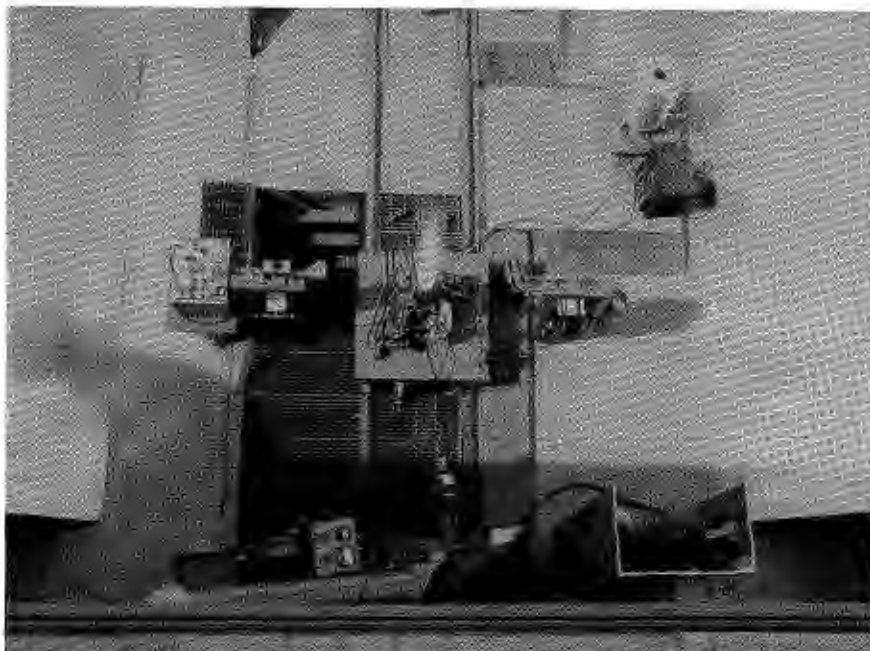

L-63-2898

Three-quarter top view of Langley’s cyanogen burner, which was located for safety reasons in a remote spot on the edge of a marsh in Langley’s West Area. To the left of the jet is a microwave “horn,” a device for electron-concentration measurement and radio-transmission attenuation.

The MPD program was particularly valuable to the little-known NASA project RAM. Initiated too late to help in the communications blackout problems of the Mercury and Gemini capsules, the purpose of Project RAM was to support the Apollo program. Many of the project’s results proved inconclusive, and most of the hoped-for technological fixes, for example, the use of higher radio frequencies and the timed injection of small sprays of water into the hot gas envelope surrounding a reentering spacecraft, were judged too problematic for use in Apollo. However, MPD specialists at Langley did learn how to predict the flow-field characteristics of a reentering spacecraft more accurately, and their work led to viable schemes for alleviating or “quenched” part of the plasma sheath so that some level of effective radio communications to and from a reentering vehicle could occur.³⁴ Experience gained in the MPD reentry experiments of the 1960s eventually aided in projecting the reentry conditions of the Space Shuttle.

The Barium Cloud Experiment

Not all of Langley's MPD work sought such direct technological applications as Project RAM. Some of the more fruitful research efforts fell into the realm of basic science and represented what MPD Branch Head Ellis described in a February 1962 briefing to the Langley senior staff as "examples of keeping research alive on a reasonable scale without solid, specific applications or even the guarantee of applications!"³⁵ One such effort that made significant contributions was a barium cloud experiment designed for exploration of the interaction between the solar wind and the earth's magnetic fields.

Although a continuous outpouring of plasma appeared to emanate from the sun (i.e., the solar wind), this plasma by virtue of its high conductivity did not seem to penetrate the earth's strong magnetic field; instead, the solar wind flowed around the earth's field, forming a huge cavity. Sensitive magnetometers aboard some of the first Soviet and American spacecraft provided useful information about the disposition of the magnetic fields within this cavity; however, many questions about the arrangement of the field lines remained unanswered. Conservative estimates of the volume of the cavity placed it at about 60,000 times the volume of the earth. Langley's interested MPD experts knew that it was "going to be a formidable task indeed to map such an extensive field by point to point samplings."³⁶ Little was known about the shape of the cavity on the nightside of the earth, and indeed astrophysicists had suggested that the cavity was in fact open and that the earth's magnetosphere had a tail extending out some several "astronomical units."*

These were only some of the complications stirring the "intellectual stew" over the magnetospheric cavity. Other concerns stemmed from evidence that the magnetic field lines of the earth were linked at least partially with those of the interplanetary field, which in turn were entrained in the solar wind. If so, tangential stresses and drag forces in the realm of space affected motions within the magnetosphere in addition to those imparted by the earth's own rotation, which were themselves unknown.³⁷

At Langley, these cosmological matters were of particular interest to the small group of theoretically inclined researchers working in the MPD Space Physics Section under David Adamson. Beginning in late 1963, the Adamson group began to seriously consider a novel experimental technique by which scientists could use an artificially ionized plasma "cloud" as a space probe. As Adamson explained at the time, the principle of the cloud was rather simple.

* An astronomical unit is usually defined as the mean distance between the center of the earth and the center of the sun, i.e., the semimajor axis of the earth's orbit, which is equal to approximately $92.9 \times 1,000,000$ miles or 499.01 light seconds.

If a charged particle is projected into a magnetic field, it spirals along a magnetic field line, remaining tied to that field line until it is dislodged by colliding with another particle. Picture then a cloud of charged particles, sufficiently dispersed at a sufficiently great altitude that collisions can be ignored. The individual particles will be tied to the field lines, and motions of the cloud perpendicular to the field lines will be inhibited. Of course, the cloud can and will diffuse along the field lines, and as it does so will serve to define the shaping of those field lines to which it is frozen. Moreover, if the magnetic field lines are themselves in motion, this motion, too, will be imparted to the cloud.³⁸

Only three requirements were placed on the cloud: it had to be fully ionized, the ionized atoms had to show resonance lines in the visible portion of the spectrum, and it had to be visible to observers on earth.

The notion of an ionized cloud was not new. For several years, research groups around the world had been experimenting with chemical releases as a means of exploring the nature of the upper atmosphere. For the most part, the creation of such artificial clouds was done by launching a sounding rocket carrying on its nose a payload of pyrotechnic constituents mixed with alkali metals. At the proper altitude in the upper atmosphere, a canister carrying the payload would be ejected. The temperature of the canister's contents would rise thousands of degrees and then escape explosively to form a colorful vapor whose atoms would glow blue-violet in the sunlight. The result was a bright and rather beautiful space cloud, a sort of instant aurora, which could be seen quite distinctly by an observer watching from the night side of the earth. Highly responsive magnetometers and spectroscopes could then be used to analyze the physics of what happened when a body of charged particles exploded in the outermost realms of the earth's atmosphere and at the fringes of space.

The world leaders in developing the tricky optical cloud technique were the West Germans, specifically a group of experimental astrophysicists in the Gaerching Laboratory of the Max Planck Institut in Berlin. The leading figures in the development of what came to be known as "the barium bomb" were Dr. Ludwig Biermann and his associate Dr. Riemar Lust. In 1951, Biermann had anticipated Parker's discovery of the solar wind by hypothesizing that a comet's tail, which always points away from the sun, was being pushed by streams of solar particles. He spent the rest of the decade looking for an experimental means by which to prove his theory. By the late 1950s, the Biermann group had developed a technique for the creation of an artificially ionized cloud in the upper atmosphere. By 1964, although the existence of the solar wind was by then taken for granted, the same group was ready to use more powerful rockets to deploy the first of these clouds in space.

Biermann and Lust used a payload of barium inside their canisters. In their opinion, a mix of copper oxide and barium (a soft, silver-white, metallic element obtained when its chloride was decomposed by an electric current)

Spaceflight Revolution

was most desirable because it ionized at a reasonable temperature and even in modest concentration could produce clouds visible to observers on earth. In the early 1960s, French sounding rockets fired from the Sahara began carrying West Germany's barium payloads into the upper atmosphere as part of a research program sponsored by the newly founded European Space Research Organization (ESRO). NASA's space scientists naturally knew about the European program, and some of them thought, like Biermann and Lust, that the barium cloud technique could be adapted for experimental use in space.³⁹

In the summer of 1964, Bob Hess traveled to Feldafing, near Munich, Germany, to participate in an international symposium on the diffusion of plasma across a magnetic field. At this meeting, Hess spoke with Biermann about the barium cloud technique. The interest of the West Germans in the experiment was different from that of Langley's MPD Branch. The Germans wanted to release barium in the streaming solar wind outside the magnetosphere in the hope of learning more about the formation of comets; the NASA researchers sought to explore the magnetosphere itself. Nevertheless, the interests were similar enough to make Biermann and Hess agree that some measure of international cooperation would be useful.

Upon his return to Langley, Hess wrote a letter to NASA's Space Sciences Steering Committee. Founded in May 1960 by the head of NASA's Office of Space Sciences and Applications (OSSA), Dr. Homer Newell, this committee consisted of NASA officials and leading academic scientists in the field. Their duty was to advise NASA on its space science program and evaluate proposals for scientific experiments on NASA missions. In his letter, Hess summarized the observational possibilities of plasma clouds as magnetospheric probes and proposed that NASA devise a cloud experiment, which perhaps could be done with the cooperation of Dr. Biermann and the West Germans. Instead of launching the barium from inside a rocket, Hess suggested that the makings for the plasma cloud be released from inside the MORL that NASA was planning, "where the advantages of longer observation of the plasma cloud and of a wider choice of materials are offered as compared with observation from the ground through the atmosphere."⁴⁰

The space scientists at NASA headquarters were interested in the general idea, but plans to proceed progressed slowly through 1965 and 1966. Other space science experiments more directly supportive of the Apollo lunar landing program, like the Surveyor and Lunar Orbiter programs, received the highest priority. Still, the MPD Branch in conjunction with the appropriate program officers at NASA headquarters, as well as with the technical support of the Applied Materials and Physics Division at Langley, continued to plan for the cloud experiment. From Wallops Island, NASA would launch an explosive canister atop a high-altitude rocket.* Early on,

* The type of rocket was yet to be determined. Ultimately, several sounding rockets, as well as Langley's multipurpose Scout rocket, would be used.

The "Mad Scientists" of MPD

Langley researchers thought that the canister should contain a combustible mixture of cyanogen-oxygen with cesium; however, with input from Lust's team in Germany, they finally chose a barium payload. At the appropriate altitude in space (the rocket would not go into orbit), the canister would detonate and out would float the ionized particles which would form the space cloud. The cloud would last several minutes to more than one hour during which it would reflect radio waves and could be viewed from a location on earth in the sun's shadow.

The general scientific purpose of the cloud would be to serve as "a ready means of discerning on a large scale the topology of the earth's [magnetic] field and of determining magnetospheric motions." However, Langley's MPD group felt that the cloud might also be used as an aid in tracking high-altitude vertical sounding rockets or even vehicles (hopefully not Soviet) bound for the moon. It could be used as a form of visible tracer, not altogether unlike the use of certain metallic elements (often barium) and radioactive isotopes fed into the stomach or injected into the blood as tracers for X-ray diagnosis of cancer and other diseases.⁴¹

Eventually, NASA gave the go-ahead for the barium cloud-in-space experiment. The approval was in part politically motivated; NASA wanted to encourage international cooperation, at least in certain noncritical space endeavors, and especially with the democratic nations of western Europe. In June 1965, representatives of the Max Planck Institut approached NASA with a proposal for a joint barium cloud experiment involving German payloads and NASA launches from Nike-Tomahawk and Javelin rockets. The following month, NASA and West Germany's Federal Ministry for Scientific Research signed a memorandum of understanding calling for cooperation in a program of space research on the earth's inner radiation belts and aurora borealis. According to the memorandum, NASA would provide a Scout booster for the launch of a German-made satellite into polar orbit by 1968, with the results of the experiment to be made available to the world scientific community. Pursuant to another memorandum of understanding between the two nations (signed in May 1966), the two research agencies would then proceed with investigations of cometary phenomena, the earth's magnetosphere, and the interplanetary medium through studies of the behavior of high-altitude ionized clouds.⁴²

Four months later, on 24 September 1966, in a joint effort with the Max Planck Institut, NASA launched a four-stage Javelin sounding rocket from Wallops Island to check its canister-ejection technique, and on the next day, again from Wallops, launched a Nike-Tomahawk rocket which released a mixture of barium and copper oxide. The second "shot" only reached 160 miles, whereas the desirable altitude for a barium cloud release was 3 to 5 earth radii. Nonetheless, the experiment was successful. For hundreds of miles up and down the Atlantic coast, three distinct clouds were visible. NASA and West German scientists photographed the clouds in an effort to track and measure electric fields and wind motions in the upper atmosphere.

Spaceflight Revolution

The results of both launches caused quite a public stir. Some residents along the coast reported sightings of brilliant UFOs, and some motorists became so fascinated by the brightly colored clouds that they ran off the road.

What came to be known formally as the MPI (Max Planck Institut)/NASA Magnetospheric Ion Cloud Experiment was the next step in the two parties' cooperative investigation. Proposed formally by the Germans in February 1967, the joint experiment was not approved by NASA until December 1968. According to the final agreement, the Germans would provide the barium payload, two ground observer stations, and data analysis; NASA would furnish the rocket, conduct the launch from Wallops Island, and provide tracking and communications services.⁴³

Despite a fatal explosion on 5 October 1967, at the Downey, California, plant of North American Rockwell, which was caused by a mishandling of finely divided barium mixed with Freon, the barium cloud experiment eventually proved a great success.⁴⁴ On 17 March 1969, a barium cloud 1865 miles long, lasting some 20 minutes, and visible to the naked eye, formed at an altitude of 43,495.9 miles (69,999.87 kilometers). *Heos 1*, a "Highly Eccentric Orbiting Satellite" belonging to ESRO, carried the cloud-producing canister into space. Instrumented observation of this and subsequent plasma cloud-in-space experiments revealed the motions of the earth's magnetic field lines, including those influencing the aurorae; demonstrated other plasma effects in space; helped scientists to correlate these motions and effects as a function of solar flares; and generally allowed world astrophysicists to model the geomagnetosphere more accurately. All the barium cloud shots generated considerable public concern and interest and were widely announced in advance in the press.

Aside from fascinating the public, this experimental probing of the near-earth environment of space also led researchers to explore what was believed to be the great potential value of magnetospheric data for understanding and perhaps even controlling the earth's weather. Although the energies in space were recognized to be small compared with those in the atmosphere, those researchers interpreting the results of the barium cloud experiment raised the possibility that even small disturbances of inherently unstable regions in space could trigger significant behavior in large regions around the earth.

The few people outside Langley who remember the barium cloud research program believed NASA left most of the interpretation of the results to the Germans. In truth, as the NASA reports on the program demonstrate, Langley's space physics group moved ahead very quickly to interpret the data, "scooping" the preeminent Germans by first reporting and explaining in full many of the essential findings.⁴⁵

NASA Langley planned to participate in at least one follow-on barium cloud test in 1974 or 1975. The purpose of this proposed test was to shape the barium charge along a magnetic field line, then time the discharge to coincide exactly with the passage of an unmanned satellite having a very high-frequency (VHF) receiver aboard. The receiver would measure the

cyclotron radiation from the electrons circling the field line. The test did not take place, however, because of the lack of support in the OSSA at NASA headquarters.⁴⁶

The Search for Boundless Energy

Astrophysics was not the only driving force behind the explosion of MPD research in the 1950s. Another inciting factor was the quest for atomic energy. After World War II and the dawn of the atomic age, many physicists had begun exploring ways to confine plasmas magnetically in a new sort of nuclear reactor based not on fission but on fusion. Such projects were designed to explore the potential of generating thermonuclear power. Many researchers and institutions believed this was the pot of gold at the end of the MPD rainbow.

In 1951 the four-year-old U.S. Atomic Energy Commission initiated a secret project known by the code name “Sherwood”; its ambitious objective was the controlled release of nuclear energy through stable confinement of plasmas at an extremely high temperature. Interestingly, the strategy behind Project Sherwood was not to build a scientific and technical base for advanced fusion experiments; rather, the goal was to immediately develop a working technology. Researchers were “to invent their way to a reactor,” so to speak, just as the scientists and engineers through a crash effort had built the first atomic bomb. Such was the mood of optimism and enthusiasm over the human capacity for solving any problem, however monumental, in the wake of the successful Manhattan Project.⁴⁷

Many of the devices developed during Project Sherwood served as advanced research tools. Although highly varied in their designs, almost all the facilities tried, with only partial success, to produce fusion reactions through some type of magnetic containment of a plasma. By the 1950s, scientists knew that a thermonuclear reactor would require a reacting gas with a temperature of at least 1,000,000,000 kelvin (K). Because containment of such an extraordinarily hot gas by solid walls seemed impossible, many plasma physicists believed that the only way to contain the gas was by powerful magnetic forces. Further work in MPD became vital.

At Langley, as elsewhere, researchers turned to the sun (a giant fusion reactor) to find the answers. In Langley laboratories, the MPD group worked on designing facilities that would simulate the activity of the solar corona. George Wood’s MHD Section built several highly experimental devices to study solar physics; however, none of them yielded the secret of thermonuclear power.

Consider, for example, George Wood’s first highly experimental facility for the basic study of solar-coronal physics, the one-megajoule theta-pinch.

Spaceflight Revolution

“The pinch” used a powerful, one-million-joule* discharge of direct-current (DC) electricity along a single-turn coil to generate a strong longitudinal magnetic field. Wood’s section hoped that an interaction of this high-density current with its own magnetic field would cause a contained column of plasma (that is, a molten conductor) to self-contract and become pinched even tighter and perhaps even to rupture itself momentarily, thus producing a controlled fusion reaction.

First explained in a theoretical paper by American physicist Willard H. Bennett in 1934, the application of this self-focusing pinch effect had become a basic mechanism of plasma and plasma-containment research worldwide in the 1950s. Langley’s MPD enthusiasts (notably MHD’s Nelson Jalufka) naturally wanted to get involved. Unfortunately, research in the Langley pinch facility, as in all other reactors of the time designed to generate controlled nuclear fusion, did not lead to fundamental breakthroughs. It did, however, make some solid contributions to the literature.⁴⁸

Another device that perhaps did not live up to all expectations but nonetheless succeeded in fundamental respects was Langley’s Magnetic Compression Experiment. In the early 1960s, Karlheinz Thom, Goetz Oertel, and George Wood devised an experimental apparatus capable of generating a multimillion-degree-kelvin plasma for simulation of the solar corona and for studying the processes that produce highly ionized atoms in the corona. Completed in 1965 at a total cost of roughly \$2 million, the apparatus consisted of a one-megajoule capacitor bank (a device for storing electrical energy) plus a straight narrow tube that produced a theta-pinch. Experiments conducted with this device led to some significant results on the spectral lines of highly ionized gases like deuterium and argon, and members of Wood’s MPD group published several papers on the experiments into the late 1960s. Well after the dissolution of the MPD branch in 1970, the facility was still operating, thanks largely to the support of Karlheinz Thom, who had moved to a position of patronage in the OSSA at NASA headquarters. Thom was able to keep the Magnetic Compression Experiment alive by relating its research more directly to astrophysics, thereby circumventing a policy of the Nixon administration against basic research in the highly speculative energy field of thermonuclear fusion.⁴⁹

A third important fusion research effort of the MHD Section involved the plasma-focus research facility. Although the stated purpose of this facility (whose operation dates to the mid-1960s) was to simulate and study the physics of solar flares, its real purpose from the outset was to explore

* A joule is equivalent to one watt-second.

the possibilities of fusion.* Essentially, the plasma-focus apparatus was a coaxial arrangement wherein a sheet of electrical current was created by a high-energy discharge from a powerful capacitor bank. The current sheet traveled down a ring-shaped (annular) channel designed around a central anode (positive electrode) and collapsed by virtue of its own self-induced magnetic field into a high-density plasma.

Several researchers in Wood’s MHD Section became deeply involved in experiments with the plasma-focus facility, and although their work did not produce the boundless energy of nuclear fusion, it cannot be called a failure; rather, the effort, which was extensive, turned out to be important and lasting. Between 1968 and 1985, Langley researchers published no less than 81 papers based on their experiments in the plasma-focus facility; only 7 of these papers were written between 1968 and 1970, when the MPD Branch was still functioning. Clearly, the research did not end with the formal dissolution of the branch. In this collection of papers authored or coauthored by the members of the former MPD Branch are significant offshoots from the initial purpose of the experiments. These offshoots include exploration of space-based lasers both for direct conversion of solar energy and for early “Star Wars” designs. In the late 1970s, the plasma-focus facility received national and international attention and acclaim by producing more neutrons per experimental “shot”— 10^{19} fusion neutrons from a deuterium plasma—than had been produced by any other fusion experiment to date in the United States. By placing enriched uranium at the end of the anode, researchers were even able to get 10^{10} fissions, which was another remarkable result.⁵⁰

These achievements signified that Langley’s general fusion-related research rated near the top of the American scientific effort by the early 1980s. Langley’s work was equal to similar pioneering efforts by Winston H. Bostick at the Stevens Institute of Technology in New Jersey and G. R. Mather at Los Alamos National Laboratory in New Mexico. Of course, the chronology for this work extends beyond the period that is the focus of this book; however, the relevance of the research carried on by the MPD Branch of the 1960s extended to these significant follow-on efforts.

* A much earlier piece of equipment for plasma research at Langley known as “the diffusion inhibitor” was developed to pursue thermonuclear power. In 1938, Langley researchers Eastman N. Jacobs and Arthur Kantrowitz tried to confine a hot plasma magnetically and thereby achieve a controlled thermonuclear reaction. Although NACA management quickly stopped the unauthorized research, the preliminary experiments attempted by Jacobs and Kantrowitz in their toroidal (or doughnut-shaped) chamber represent not only Langley’s first flirtation with the basic science later leading to MPD studies but also the first serious effort anywhere in the world (and three years before the Manhattan Project) to obtain energy from the atom. For a complete account of the Jacobs-Kantrowitz fusion experiment of 1938, see James R. Hansen, “Secretly Going Nuclear,” in *American Heritage of Invention & Technology* (Spring 1992) 7:60–63.

A Hot Field Cools Off

Although the promise of MPD remained high into the late 1960s, its mystique was slowly dissipating. In a briefing to new Langley Director Edgar M. Cortright in 1968, Mike Ellis had to admit that “a large part of the glamour of moving into plasma physics that existed ten years ago is now over and we feel that hard-headed research is now the order of the day.”⁵¹

Ten years had passed, and the ambitions of the first exhilarating moments of the spaceflight revolution had been moderated by the mounting frustrations of trying to achieve significant research results in what was proving to be a much more illusive area of research than anticipated. “The field was just so incredibly complicated,” Mike Ellis remembers, “that to make a really significant contribution that would apply to some great problem just became increasingly hard.”⁵² The deeper the Langley researchers and others plunged into the MPD field, the more they realized how difficult contributing to any applications would be.

Because they could not find clear applications for most of their research, the sights of the MPD enthusiasts changed gradually over the course of the 1960s. In terms of simulating the reentry conditions, which was the practical application driving so much of the MPD effort in its early years, neither Langley’s arc-jets, nor its plasma accelerators, nor any other new facility ever succeeded in generating on the ground a flow of high-temperature air that corresponded to actual flight conditions. And, by the late 1960s, NASA knew that a spaceflight program could do well without having that capability. As John Becker of Aero-Physics explains,

We learned everything that we could in an airstream that was way too cool, and then we corrected wherever we needed to for the effects of the temperature, by calculation, by studying the effects of temperature in adequate facilities, and then adding that to what we already knew. It was a partial simulation, but the corrections were good enough to design successful hardware.⁵³

In other words, much of what MPD researchers had been trying to do just proved unnecessary.

The primary motivation for many who had joined the MPD field had been the hope of controlled thermonuclear fusion. Anybody and everybody in the scientific community who was connected to plasma physics had the dream of inventing the final device that would allow controlled fusion, or at least they hoped to contribute in some direct way to its eventual design. But by the late 1960s, the lack of progress in the field clearly indicated that any practical technology based on fusion (other than an atomic bomb or nuclear warhead) was still a long way off.⁵⁴

At the dawn of the space age, NASA’s MPD enthusiasts at Langley and elsewhere had also believed that nuclear-powered rockets, ion rockets, and other advanced space propulsion systems might be just around the corner

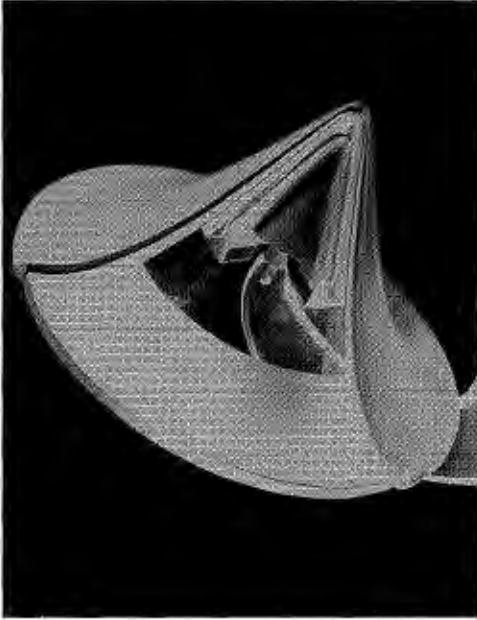

This May 1965 photograph shows a Langley concept for a Mars landing vehicle. By the end of the decade, all thoughts of making a quick trip to Mars ended.

L-65-3960

and that with them astronauts would soon be shooting off for Mars and other faraway places. As the decade passed, the idea of the nuclear rocket fell by the wayside and was for all practical purposes killed when NASA planning for a manned Mars mission was put to an abrupt halt in 1970 by President Nixon. The value of exploring the potential of electric propulsion systems also diminished. Mike Ellis remembers the impact of the presidential policy on his own work: “In early 1970, I was told to cease working immediately on a paper I was preparing for formal presentation on the proposed manned mission to Mars. The paper, on which I was working with Walter B. Olstad and E. Brian Pritchard in the Aero-Physics Division, was all ready for rehearsal. But then word came down from Washington, and I was told not even to breathe the notion of a manned Mars mission.”⁵⁵

As their lofty aspirations were forced down to earth, the MPD enthusiasts shifted their focus and began to look for other objectives. A group in the Plasma Physics Section, for example, started to explore the potential of gas lasers. Under the direction of Bob Hess and his associate Frank Allario, this new area of interest grew into a sustained field of intense research at NASA Langley. By the early 1970s, this effort provided some information basic to the eventual development of the plasma cutting torches and plasma metal-definition apparatuses that have since come to dominate the metals field.⁵⁶

Spaceflight Revolution

In 1970, Edgar Cortright as part of his major reorganization of the center dissolved the MPD Branch and put most of its people and many of their facilities under a new Space Sciences Division headed by William H. Michael. Aware of MPD's practical limitations, Mike Ellis did not complain about his branch's dissolution, nor did any other member of his staff.* Cortright was somewhat familiar with the MPD field from his days as a researcher at Lewis laboratory and from his management experience in the OSSA at NASA headquarters, so he did not criticize MPD's work or refer to it in any way as a failure. John Becker, who had supported his MPD Branch for nearly a decade, best sums up Langley's view of MPD: It was "a field that we had to explore in detail because of the great promise. The fact that it didn't yield any earth-shaking new things is not our fault. It's just the way nature turned out to be."⁵⁷

Never before in the history of applied basic research at Langley had a field of study promised so much, yet delivered so little. But the "mad scientists" of MPD were not mad in their pursuit; they were just different from the "normal" body of researchers at Langley, who searched for practical solutions and did not stray into matters of fundamental cosmological importance. The MPD group's commitment to basic scientific research was in fact quite sensible. At a time when NASA had an increasingly strong political mandate for research that was "relevant" to the technological objectives of space projects, the "mad scientists" of MPD maintained a broader and more fundamental interpretation of relevant research.

Mike Ellis would always feel that MPD's interpretation was the proper one and that the urgency of project work had deteriorated the status of basic research at Langley. Project work so dominated the agency in the late 1960s that all work, even basic research such as that conducted by the MPD Branch, was judged by the black-and-white criteria for project success. Results must be quickly achieved and immediately applicable. The results of Langley's MPD work were neither. Mike Ellis puts the experience in perspective: "It is certainly true that we didn't produce any earth-shaking results or great breakthroughs. Not many efforts do."⁵⁸

* Ellis himself, however, did not move into the new Space Sciences Division; instead, he became one of the assistant chiefs (and later associate chief) of John Becker's Aero-Physics Division. Paul Huber, head of the Plasma Applications Section, became head of Aero-Physics's Propulsion Research Branch, which worked on hypersonic scramjets.

6

The Odyssey of Project Echo

The vitality of thought is an adventure. Ideas won't keep. Something must be done about them. When the idea is new, its custodians have a fervor. They live for it.

—*Dialogues of Alfred North Whitehead*

*For the things we have to learn before we can do them,
we learn only by doing them.*

—Aristotle

In the early hours of 28 October 1959, five days after the close of the first NASA inspection, people up and down the Atlantic coast witnessed a brilliant show of little lights flashing in the sky. This strange display, not unlike that of distant fireworks, lasted for about 10 minutes. From New England to South Carolina, reports of extraordinary sightings came pouring into police and fire departments, newspaper offices, and television and radio stations. What were those mysterious specks of light flashing overhead? Was it a meteor shower? More Sputniks? UFOs? Something NASA finally managed to launch into space?

Several hours later, the press was still trying to solve the mystery. At about three o'clock in the morning, a night watchman roused NASA Langley rocket engineer Norman L. Crabill from a sound sleep in a dormitory near the launchpads on Wallops Island. The watchman told Crabill that a long-distance telephone call was waiting for him in the main office. A reporter for a New York City newspaper wanted a statement about, as he put it, "the lights that you guys had put up." Crabill, an irascible young member of Langley's PARD, had not been able to celebrate his thirty-third birthday properly the night before because of what had happened, and now he had gotten out of a warm bed, put on his pants, and taken a walk in the cool night

Spaceflight Revolution

air just to explain the situation to some newspaper guy. "My statement is, 'It's three o'clock in the morning,'" growled Crabill, slamming the receiver down. As he would later remember, "It was the only time I, a government employee, ever told off the press and got away with it."¹

Given the events of that evening, Crabill's anger was understandable. Although the disaster that had occurred was minor, it was big enough to potentially damage Crabill's NASA career. The initial test of a 110-foot-diameter inflatable sphere for the Echo 1 Passive Communication Satellite Project had ended abruptly with the sphere blowing up as it inflated. Floating back into the atmosphere, the thousands of fragments of the aluminum-covered balloon had reflected the light of the setting sun, thus creating the sensational flashing lights.

The inflatable sphere had been launched from Wallops Island at 5:40 p.m. For the first few minutes, everything went well. The weather was fine for the launch, and the winds were not too high. PARD engineers were worried about the booster called "Shotput," an experimental two-stage Sergeant X248 rocket, because the performance of the rocket's second-stage Delta was to be the initial test of the U.S. Thor-Delta satellite launching system. However, in the early moments of its test flight, *Shotput 1* had performed flawlessly. The rocket took the 26-inch-diameter, spherical, 190-pound payload canister—inside of which the uninflated 130-pound aluminum-coated Mylar-plastic satellite had been neatly folded—to second-stage burnout at about 60 miles above the ocean. There, the payload separated successfully from the booster, the canister opened, and the balloon started to inflate. The first step in Project Echo had been taken with apparent success.

Then, unexpectedly, the inflating balloon exploded. The payload engineers had left residual air inside the folds of the balloon *by design* as an inflation agent. The air expanded so rapidly, because of the zero pressure outside, that it ruptured the balloon's thin metallized plastic skin, ripping the balloon to shreds. *Shotput 1* was history; the use of residual air to help blow up the balloon had been, in Crabill's words, a "bad mistake."²

After spending a depressing night reviewing why the test went wrong, the only thing for Crabill to do the next morning was to get to work solving the problem. After all, this was project work—the ultimate reality—not general research. No time to cry over spilled milk—or burst balloons.

At the NASA press briefing at Wallops, held about one hour after the explosion, Crabill and others had given their usual matter-of-fact postlaunch systems report. In the midst of taking a quick look at the telemetry records to make sense of the balloon failure, a NASA official sensitive to public affairs approached Crabill and told him, "Just tell them everything worked all right."³ Sure, Crabill thought, no problem. No data pointed to the contrary. All the visual evidence on the Shotput launch vehicle, which was Crabill's responsibility, suggested that Shotput had worked as planned. Moreover, the

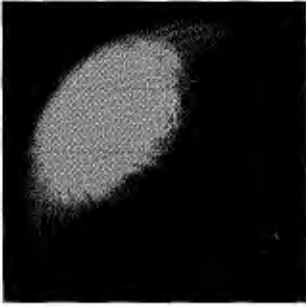

L-93-8337



L-93-8339



L-93-8333

During a test of the Echo deployment in 1962, which was three years after Shotput's first failed deployment of the Echo satelloon, a structural load problem caused the balloon once again to explode. A camera aboard the launcher captured these images. The earlier Shotput failure would have looked very much the same.

purpose of the Shotput phase of Project Echo* was to determine whether the mechanism designed to deploy an inflatable passive communications satellite of that size and weight would work, and it had; in that sense, *Shotput 1* was indeed successful. To tell the whole truth about that scintillating collection of little moving lights tumbling through the upper atmosphere before all the records were examined and understood was premature—and the complete story would be too complicated for the press to understand. This was a time when launching any object into space was big news for the American people. Why let an otherwise uplifting moment be turned into another letdown?

Thus, for the initial newspaper stories about the launch of *Shotput 1*, the press would not be told enough even to hint at the possibility of a failure. For example, in a front-page article appearing in the next morning's *Newport News Daily Press*, the headline for military editor Howard Gibbons' article about the launch was: "Earthlings Stirred by NASA Balloon, Awesome Sight in the Sky." According to Gibbons, NASA had launched "the largest object ever dispatched into space by man, stirring the curiosity and awe of thousands of Americans residing on the Eastern Seaboard." The inflated sphere "rode for 13 minutes in the sun's rays ... before it fell again into the atmosphere and dropped into the Atlantic about 500 miles east of Wallops." Gibbons made no mention of the rupture. The balloon "was probably deflated on the way down into the atmosphere, NASA reported." Not a word appeared about a mistake involving the use of residual air as an inflation agent. According to Gibbons, "NASA's assessment of the operation was that 'it did what we wanted it to do.'"⁴

Also on the front page of the *Daily Press* that morning, next to the article on *Shotput 1*, was an Associated Press wire story from Washington, D.C., announcing the start of extensive congressional hearings. The House

* The word "echo" was already in use by the late 1950s to describe a pulse of reflected radio-frequency energy.

Spaceflight Revolution

Space Committee was investigating why the United States continued “to play second fiddle” to the Soviets in the exploration of space; the headline of this second article read: “Why U.S. Lagging In Space Explorations To Be Probed.” The last thing NASA needed at the moment was to explain a burst balloon.

Norm Crabill knew that NASA was not telling the press the truth, but he and the rest of the Langley crew responsible for the shot understood and accepted the subterfuge. This was project work, and it *had* to succeed. For public consumption, both failure and the inability to achieve complete success need not be admitted, at least not immediately. Sometimes mistakes could not be concealed, such as a missile blowing up on the launchpad before hundreds of cameras, as so many had been doing. But a balloon bursting in space, especially one producing such a sensational show of flashing lights, could be presented as a total success. This age of the spaceflight revolution was a new epoch. Research activities were now exposed to the nontechnical general public, and so many old rules and definitions no longer were applicable. Some discretion in the discussion of results seemed justified.

The International Geophysical Year and the V-2 Panel

As with so many early NASA projects and programs, Project Echo originated in NACA work. In fact, the idea predated the Sputnik crisis by several months and at first had nothing to do with proving the feasibility of a global telecommunications system based on the deployment of artificial satellites. Rather, the original purpose of Echo was to measure the density of the air in the upper atmosphere and thereby provide aerodynamic information helpful in the design of future aircraft, missiles, and spacecraft. Like so many other matters affected by the spaceflight revolution, the concept that led to Project Echo had modest and circumscribed beginnings that ballooned into sensational results.

The father of the Echo balloon was Langley aeronautical engineer William J. O’Sullivan, who was a 1937 graduate of the University of Notre Dame (and Langley employee since 1938) and a former staff member of PARD. The idea for the air-density experiment first came to O’Sullivan on 26 January 1956, nearly two years before the launch of *Sputnik 1*. All that raw winter day, the 40-year-old O’Sullivan sat in a meeting of the Upper Atmosphere Rocket Research Panel, which was being held at the University of Michigan in Ann Arbor. Originally known as the “V-2 Panel,” this body had been formed in February 1946 to help the army select the most worthwhile experiments to be carried aboard the captured and rebuilt German V-2 rockets.* After World War II, scientists from around the country

* The V-2 rockets were originally known as A-4s. To avoid association with the German “Vengeance Weapons” that had terrorized England, the U.S. military often referred to them by their original name.

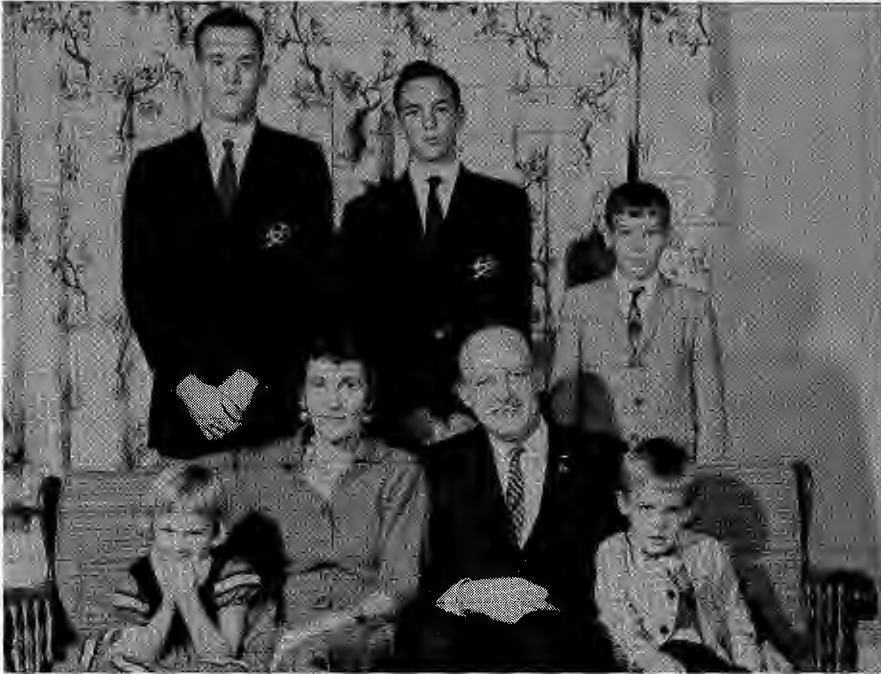

L-61-7786

William J. O'Sullivan, the father of the Echo balloon, was also the father of five children. They, too, were caught up in the enthusiasms of the spaceflight revolution. Notice the homemade NASA emblems on the blazers worn by the two teenage sons. The NASA public affairs office distributed copies of this family portrait to the news media along with stories about O'Sullivan's ingenious invention of the Echo balloon.

had flooded the army with requests for an allotment of space aboard the V-2s, and the army had handled the awkward situation rather adroitly by instructing the scientists to form a panel of their own to decide which experiments should go on the rockets. Thus, the V-2 Panel came to life as a free and independent body, with no authority to enforce its decisions, but with a voice that carried the weight of the scientific community behind it. By the early 1950s, the name of the panel changed to the Upper Atmosphere Rocket Research Panel, signifying both a wider agenda of research concerns and the use of rockets other than the V-2s as flight vehicles.⁵

The purpose of the Ann Arbor meeting was to choose the space experiments for the forthcoming International Geophysical Year (IGY). This event, to be celebrated by scientists around the world beginning 1 July 1957, stimulated many proposals for experiments, including the stated ambition of both the American and Soviet governments to place the first artificial satellites in orbit about the earth. The panel's job was to sort these proposals into two groups: those that could most satisfactorily be conducted with sounding rockets and those that could be performed aboard "Vanguard," the proposed

Spaceflight Revolution

National Academy of Sciences/U.S. Navy earth satellite. Then, after hearing 20-minute oral presentations in support of each proposal, the panel, chaired by University of Iowa physicist James Van Allen, was to choose the most deserving experiments.⁶

As the NACA representative to this panel, O'Sullivan sat through the day-long meeting and grew increasingly frustrated with what he was hearing. He was particularly disappointed by the methods proposed to measure the density of the upper atmosphere. As an aeronautical engineer, he understood that information about air density might prove vital to the design of satellites, ICBMs, and every aerospace vehicle to fly in and around the fringes of the earth's atmosphere. In 1952 and 1953, O'Sullivan had belonged to a three-man study group supported by Langley management for the purpose of exploring concepts for high-altitude hypersonic flight. With fellow Langley researchers Clinton E. Brown and Charles H. Zimmerman, O'Sullivan had educated himself in the science of hypersonics and helped the group to conceptualize a manned research airplane that could fly to the limits of the atmosphere, be boosted by rockets into space, and return to earth under aerodynamic control. In essence, the Brown-Zimmerman-O'Sullivan study group had envisioned a "space plane" very similar to the future North American X-15 and its related heir, the Space Shuttle.⁷

Given his enthusiasm for spaceflight, O'Sullivan was disappointed to hear respected scientists offering such defective plans for obtaining the critical air-density data. One proposal, developed by a group at the University of Michigan, involved the use of a special omnidirectional accelerometer whose sensitivity, according to O'Sullivan, would have to be "improved by between 100 and 1000 times before the experiment would work." Another proposal, one of two submitted by Princeton University physicist Lyman Spitzer, Jr., called for the measurement of drag forces on a satellite spiraling its way back to earth. In O'Sullivan's view, the principle behind Spitzer's proposal was sound, but not practical. The experiment would work, he predicted, "only at altitudes much below that at which practical satellites of the future would have to fly in order to stay in orbit long enough to be worth launching, probably at least five years."⁸ Several of the day's proposals, including the ones just mentioned, were based on the presumption that somebody could build and launch a lightweight structure strong enough to remain intact during its turbulent ballistic shot into space. But as far as O'Sullivan knew, nobody had yet discovered how to do this. At that moment, still more than a year and a half before Sputnik, no one had yet succeeded in launching even a simple grapefruit-sized object into space, let alone objects as big and complicated as those being suggested by the scientists that day in Ann Arbor.

In his hotel room that evening, O'Sullivan could not let go of the problem. None of the proposals he had heard were satisfactory. But were there better alternatives? Even if he could think of one himself, technically, as a panel member, he was supposed to judge the suggestions formally submitted by

others, not make any of his own. With a pad of paper from the hotel desk in hand, however, he could not resist making some rough calculations. Over the next several hours, O'Sullivan was engaged in a process of creative problem solving, which he would later outline in seven major points of analysis.⁹

O'Sullivan's Design

(1) *Aero theory.* O'Sullivan naturally started his analysis from the point of view of aerodynamic theory. He knew from theory that "the drag force experienced by a satellite in the outer extremities of the earth's atmosphere was directly proportional to the density of the atmosphere." This meant that "if the drag could be measured, the air density could be found." Thus, in the first few minutes of his analysis, O'Sullivan had reduced the entire problem to measuring the satellite drag.¹⁰

(2) *Shape and size.* How big should the satellite be and what shape? O'Sullivan chose a sphere. Such a fixed shape eliminated the problem of the satellite's frontal area relative to the direction of motion, and it also simplified the question of the satellite's size.

(3) *Drag forces.* O'Sullivan turned next to a consideration of celestial mechanics. On his pad of paper, he began to play with the classical equations for the drag forces on a body as it moves on a ballistic trajectory through the atmosphere and into orbit around the earth. After several minutes of mathematical work, during which he constantly reminded himself that the success of the experiment depended on making the satellite extremely sensitive to aerodynamic drag, O'Sullivan realized that he must devise a satellite of exceedingly low mass relative to its frontal area. The satellite could be a large sphere, but the sphere's material could not be so dense as to make the satellite insensitive to the very air drag it was to detect. Only an object with a low mass-to-frontal area ratio could be pushed around by an infinitesimal amount of air.

(4) *Design considerations.* No researcher who worked at such a diversified place of technical competence as Langley, which was the only NACA aerodynamics laboratory with a Structures Research Division, could long proceed with the analysis of a flight-vehicle design without considering matters of weight, loads, elasticity, and overall structural integrity. The structural problems of O'Sullivan's sphere might prove serious, for the lighter the weight (or lesser the mass), the weaker the structure. With this conventional knowledge about structural strength in mind, O'Sullivan contemplated the magnitude of the loads that his satellite structure would have to withstand. Calculations showed that the loads on his sphere, once in space, would be quite small, amounting to perhaps only one-hundredth to one-thousandth the weight that the sphere would encounter at rest on the surface of the earth. From this, he concluded that the satellite need only be a thin shell, as thin perhaps as ordinary aluminum foil.

Spaceflight Revolution

But herein was the dilemma. In orbit, the sphere would encounter negligible loads and stresses on its structure, but to reach space, it would have to survive a thunderous blast-off and lightning-like acceleration through dense, rough air. O'Sullivan knew that he could not design a satellite for the space environment alone; rather, a structure must be designed to "withstand the greatest loads it will be exposed to throughout its useful life." The satellite would have to withstand an acceleration possibly as high as 10 Gs, which was 1000 to 10,000 times the load the structure would be exposed to in orbit. To survive, the satellite could not consist merely of a thin shell; it would have to be so strong and have such a high mass-to-area ratio that it would be insensitive to minute air drag and thereby "defeat the very objective of its existence."¹¹

Midnight was approaching, and O'Sullivan, the scientific wizard of Langley's PARD, still sat at the hotel desk, perched on the horns of this dilemma. Finally, in the early hours of the morning, he arrived at a possible solution: why not build the sphere out of a thin material that could be folded into a small nose cone? If the sphere could be packed snugly into a strong container, it could easily withstand the acceleration loads of takeoff and come through the extreme heating unscathed. After the payload container reached orbit, the folded satellite could be unfolded and inflated pneumatically into shape. Finding a means of inflation should not be difficult. Either a small tank of compressed gas such as nitrogen, or a liquid that would readily evaporate into a gas, or even some solid material that would evaporate to form a gas (such as the material used to make mothballs) could be used to accomplish the inflation. (He apparently had not yet thought of using residual air as the inflation agent, as in *Shotput 1.*) Almost no air pressure existed at orbiting altitude, so a small amount of gas would do the job. "Clearly then," O'Sullivan concluded, "that is how the satellite had to work."¹²

(5) *Construction materials.* Other critical questions still needed answers. Surely, if he presented his notion of an inflatable satellite to the prestigious scientific panel the next day, someone would ask him to specify its construction material. The material had to be flexible enough to be folded, strong enough to withstand being unfolded and inflated to shape, and stiff enough to keep its shape even if punctured by micrometeoroids. O'Sullivan reviewed the properties of the materials with which he was familiar and quickly realized that "no one of them satisfied all the requirements." Next he tried combining materials. The forming of thin sheet metal into certain desired shapes was a standard procedure in many manufacturing industries, but sheet metal thin enough for the skin of his satellite would tear easily during the folding and unfolding. Perhaps, thought O'Sullivan, some tough but flexible material, something like a plastic film, could be bonded to the metal foil.¹³

Here was another critical part of the answer to O'Sullivan's satellite design problem: a sandwich or laminate material of metal foil and plastic

film. "I could compactly fold a satellite made of such a material so that it could easily withstand being transported into orbit, and once in orbit, I could easily inflate it tautly, stretching the wrinkles out of it and forming it into a sphere whose skin would be stiff enough so that it would stay spherical under the minute aerodynamic and solar pressure loads without having to retain its internal gas pressure."¹⁴ Such a thin-skin satellite would be so aerodynamically sensitive that even a minute amount of drag would cause a noticeable alteration in its orbit. Researchers on the ground could track the sphere, measuring where and when it was being pushed even slightly off course, and thereby compute the density of the air in that part of the atmosphere.

(6) *Temperature constraints.* Would a satellite made out of such material grow so cold while in the earth's shadow that the plastic film would embrittle and break apart? O'Sullivan reckoned that this would not be a problem as he knew of several plastic films that could withstand extremely low temperatures. The real concern was heat. Exposure to direct sunlight might melt or otherwise injure the outer film. But this, too, seemed to have a remedy. Rough calculations showed that high temperatures could be controlled by doping the outside of the satellite with a heat-reflecting paint. Some heat-reflecting metals might even do the job without paint, if they could be made into a metal foil.

(7) *Satellite tracking.* One problem remained: the means of tracking the satellite. As a member of the Upper Atmosphere Rocket Research Panel, O'Sullivan was familiar with current tracking techniques. These included the radio method built into the navy's Minitrack network in which the object to be tracked carried a small transmitter or radio beacon. This system would be adopted for the Vanguard satellite project. Unfortunately, the radio-tracking method would not work for O'Sullivan's satellite concept. If a radio beacon was attached to his sphere, it would add significantly to the structural mass, thereby reducing the sphere's sensitivity to air drag. The only way to track the sphere, it seemed, was optically, with special cameras or telescopes.

Tracking a satellite optically when the satellite would be made out of something as bright and highly reflective as polished sheet metal would not be difficult; however, optical tracking limited satellite observation to the twilight hours. At all other times, reflections from the satellite would not be practical. At night the satellite would be in the earth's shadow and hence would receive no sunlight to reflect to tracking instruments or observers on earth; in daylight, the satellite would reflect light, but that light would be obliterated from view by the scattering of the sun's rays in the earth's dense lower atmosphere.

O'Sullivan knew that tracking a satellite at all times of the day and at night was possible only by radar. As a member of Langley's PARD, he was intimately familiar with the radar tracking of rocket models; at Wallops Island, it had been a routine and daily procedure for several years. As

O'Sullivan suspected, the problem was that radars powerful enough to do the job, even if the satellite were as big as a house, would not be available for several years because they were still in development.

Extraterrestrial Relays

These thoughts about radar tracking led O'Sullivan to a much higher level of technological speculation. "As I thought about this ability to reflect radio and radar waves, there came a stream of thoughts about the future possibilities of such a satellite when there would exist . . . rockets capable of launching big enough satellites, and when powerful enough radars and radios [would exist] to be able to use such satellites for radio and television communication around the curvature of the earth, and as navigational aids that could be seen by ship and airplane radars night and day, clear weather or cloudy: satellites that some day might take the place of the stars and sun upon which navigators have depended for so many generations."¹⁵

On many occasions in the history of modern technology, science fiction has blazed the way to an understanding of real possibilities and has motivated scientists and engineers to seek practical results; perhaps O'Sullivan's concept for the inflatable satellite was one of those occasions. Several years earlier, in October 1945, the British science-fiction writer Arthur C. Clarke had published a visionary article in the popular British radio journal *Wireless World* suggestively entitled "Extraterrestrial Relays." In the article, Clarke predicted the development of an elaborate telecommunications system based on artificial satellites orbiting the earth.¹⁶

The key to such a system, according to Clarke, would be the "geosynchronous" satellite. Such a satellite, launched to a distance of roughly 22,000 miles high in an equatorial orbit, would, according to the laws of celestial mechanics, take exactly 24 hours to complete one orbit, thereby staying fixed indefinitely over the same spot on the earth. The satellite would act as an invisible television tower, which could maintain line-of-sight contact with one-third of the earth's surface. If three satellites were put into geosynchronous orbit above the equator and made to communicate with one another through long-distance "extraterrestrial relays," as Clarke called them, electronic signals, be they radio, television, or telephone, could be passed from satellite to satellite until those signals made their way around the globe. For the first time in history, people all over the world would be able to communicate instantaneously.

The impact of a global communications system would be revolutionary, Clarke was sure. "In a few years every large nation will be able to establish (or rent) its own space-borne radio and TV transmitters, able to broadcast really high-quality programs to the entire planet." This would mean "the end of all distance barriers to sound and vision alike. New Yorkers or Londoners will be able to tune in to Moscow or Peking as easily as to their

local station.” The new communications technology might even lead to a new order of world cooperation and peace. “The great highway of the ether will be thrown open to the whole world, and all men will become neighbors whether they like it or not.” Inevitably, peoples of all nations will become “citizens of the world.”¹⁷

We do not know if Langley’s William J. O’Sullivan (who died from cancer in 1971 at age 56) had read any of Arthur Clarke’s writings or was in any other way acquainted with Clarke’s ideas about communications satellites at the time of the Ann Arbor meeting in 1956. Most likely O’Sullivan knew something of them, given the intellectual proclivities of the flight-minded community in which he worked and the extent to which some of the bolder ideas about space exploration were making their way into the mainstream of American culture during the early 1950s through books, magazines, and movies. Some of the ambitious ideas about space, including the scheme for a global system of communications satellites, were beginning to appear in the serious technical literature.

Take the relevant case of John R. Pierce, the visionary American electrical engineer working at Bell Telephone Laboratories. In 1952, Pierce began to develop his own ideas for a communications satellite system but, fearing the ridicule of his colleagues, decided to publish his ideas under a pseudonym. They appeared in a popular magazine, *Amazing Science Fiction*. In the next few years, however, the climate of opinion changed; the electronics revolution, as well as the notion of integrating rockets, transistors, computers, and solar cells, progressed far enough to make a serious technical discussion of the possibility of “comsats” (communication satellites) professionally acceptable. Pierce then came out of the closet; in April 1955, he published “Orbital Radio Relays” under his own name in the respected trade journal *Jet Propulsion*.¹⁸

In the same month, another provocative article by Pierce appeared in the *Journal of the American Rocket Society*; in it, the Bell engineer specified the use of large spherical reflector satellites, much like the one being designed by O’Sullivan, for long-range telecommunications. Such satellites would be “passive” rather than “active.” A passive satellite served simply as an electronic mirror, retransmitting back to earth only those signals that were intercepted.* The chief advantage of a passive system, Pierce indicated, was that a passive satellite was less complicated electronically than an active satellite. Unlike a passive satellite, an active one could receive and amplify signals before retransmitting them to the ground, but, in order to do so, it had to carry its own power supply or possess the means of deriving power from external sources.¹⁹

A global communications network based on a series of geosynchronous satellites like those suggested by Pierce and Clarke interested O’Sullivan, but

* The navy was soon to use this concept as the basis for an experimental system called “Communication by Moon Relay,” in which the moon was used as a passive reflector for radar waves.

Spaceflight Revolution

in January 1956, as a member of the Upper Atmosphere Rocket Research Panel, his sights were set on a much more limited and immediate goal, the upcoming IGY. So just as quickly as he began to speculate about the potential of communications satellites in earth orbit, the Langley engineer once again narrowed his focus and concentrated on the requirements of the air-density experiment at hand. These other applications “were things for a few years in the future,” he said to himself, “not for the year 1956.”²⁰ Little did he know how quickly those wildly ambitious applications would be realized once the spaceflight revolution began.

Finessing the Proposal

Having pondered the problems of designing an air-density flight experiment into the wee hours of the morning, O’Sullivan finally went to bed. But he could not sleep. He tossed and turned, worrying that when he disclosed his idea to the Upper Atmosphere Rocket Research Panel the next day he would find that he had “overlooked some factor that would invalidate the whole idea.” At one point, he sat up in bed, laughed, and said aloud, “It will probably go over like a lead balloon!”²¹ His plastic-covered, inflatable metal-foil sphere was about as close to a lead balloon as any professional engineer would ever want to get.

The next day, January 27, after hearing several members of the panel express their disappointment in the proposed methods of measuring satellite drag and air density, O’Sullivan mustered enough courage to tell a few of the panel members about his design. He talked to Fred L. Whipple, then of the Harvard College Observatory (and soon to be named director of the Smithsonian Astrophysical Laboratory), as well as to Raymond Minzer of the U.S. Air Force Cambridge Research Center. Their principal concern was that the payload space in the Vanguard satellite was almost completely taken up by other experiments. All that was left for O’Sullivan’s inflatable balloon was a tiny space the size of a doughnut. Could the balloon be made to fit? And could it be made to weigh no more than seven-tenths of a pound? O’Sullivan was not sure about meeting either requirement, but, puffing on a cigarette, said he would try to work it out. That was enough of an answer for Whipple and Minzer. Both men urged O’Sullivan to put his proposal in writing and submit it to the U.S. National Committee/International Geophysical Year (USNC/IGY) Technical Panel on the Earth Satellite Projects, which was being formed in Ann Arbor that afternoon.²²

For O’Sullivan, the proposal posed a problem. Most technical panels of the USNC/IGY had already been formed, and he had just accepted an appointment, with the NACA’s permission, on the Technical Panel on Rocketry. Not only was he a member of this panel, but he also was responsible for coordinating the NACA’s development of two sounding rockets: the Nike-Deacon (DAN) and an improved version of it, the Nike-Cajun (CAN). Both

were to become mainstays of the USNC/IGY sounding rocket program. Furthermore, O'Sullivan knew that a rather strict USNC/IGY policy required that a "principal experimenter" accept complete responsibility for carrying out his experiment from beginning to end. The USNC/IGY would deal only with him, not with any organization with which he was associated, in all matters pertaining to his experiment, including funding. The purpose of this policy was to ensure that every scientist, regardless of institutional affiliation or backing, would enjoy an equal opportunity to propose experiments and to obtain the necessary funding from the USNC/IGY if the experiment was accepted. Taking on the heavy duties of a principal experimenter would be a full-time job that O'Sullivan could not possibly do and still hold his civil service position with the NACA. The options appeared to be either to resign his 18-year position with the NACA and obtain funding to do the experiment from the USNC/IGY or to forget about the inflatable satellite.²³

O'Sullivan found another option, which was to share the satellite project with someone else. He talked again with Raymond Minzer, this time about joining him as a "co-experimenter." Minzer agreed, and within a few weeks, the two men submitted a successful proposal to Dr. Richard W. Porter, the General Electric engineer in charge of the V-2 test program at White Sands and chairman of the Technical Panel on the Earth Satellite Projects. Unfortunately, after the proposal was accepted, the air force withdrew its support of the experiment, and Minzer had to bow out. Once again, O'Sullivan was left alone with his lead balloon, and by that time, O'Sullivan explains, the USNC/IGY Technical Panel on the Earth Satellite Projects was "hounding [him] to get the experiment under way."²⁴

Upon returning to Langley, the only option left open to O'Sullivan, besides dropping the experiment, was to secure full support from his employer. As the NACA's representative on the Upper Atmosphere Rocket Research Panel, O'Sullivan had reported all of his activities in travel reports and memoranda that were routed to the office of the Langley director (still Henry Reid), with copies forwarded to NACA headquarters. In mid-June 1956, Associate Director Floyd Thompson and Bob Gilruth, then the assistant director responsible for PARD, had heard all about the concept for an inflatable satellite. They advised O'Sullivan to prepare a formal memorandum giving the complete theory of the experiment and requesting that the NACA sponsor the experiment for development at Langley as another NACA contribution to the IGY.

Immediately, O'Sullivan wrote the proposal, dated 29 June 1956. In it, he explained why the NACA, an organization hitherto devoted to the progress of aircraft, "not only should, but must" become engaged in development of earth satellites. With the recent advances in rocket propulsion and guidance systems, O'Sullivan argued, "earth satellites can and will be developed and used for numerous defense and commercial purposes. . . . Not least among the foreseeable benefits is the lessening of world tension by bringing closer together the various nations through interest in a common

Spaceflight Revolution

beneficial development.” The development of earth satellites was therefore “inevitable.” For the NACA not to be involved with satellites would be a serious mistake. “In every industry, failure to undergo evolution in pace with technological development inevitably leads to extinction. In the field of research, by virtue of it being the technological frontier, no time lag between recognition of an important problem and initiation of work upon it can exist without loss of ground.” To begin, the NACA should perform research “particularly in the field of air drag measurement, employing lightweight inflatable spheres,” with a special task group established at Langley to perform the necessary technical work. Given the low estimated cost of the experiment, which O’Sullivan placed very conservatively at just over \$20,000, he was hopeful that NACA management would accept his proposal, even though he knew that his employer would have to bear all the expenses of developing the project because federal law prevented the NACA from accepting any funds from the USNC/IGY.²⁵

Very quickly the NACA accepted the proposal. Hugh Dryden, the director of research for the NACA in Washington, liked the concept and in September 1956 authorized John W. Crowley, his associate director, to report to the USNC/IGY Technical Panel on the Earth Satellite Projects with news of the NACA’s willingness to develop the satellite. But the advocacy was not over. Not everyone on Dr. Richard Porter’s newly constituted technical panel had heard about O’Sullivan’s idea, and many of them needed to be convinced. O’Sullivan remembers, “I had to describe [the experiment] in minute detail and defend it against all scientific and technical objections the [panelists] could think of.” This was “the acid test,” for most members of this panel came from academe and not from government; everyone on the panel had a Ph.D., and O’Sullivan did not. After a careful presentation of his proposal, however, O’Sullivan managed to clear the hurdle and persuade the panel to accept the NACA project. At a meeting on 9 October 1956, Porter’s committee put it on the official list of approved experiments and designated O’Sullivan as the principal experimenter. The committee was convinced that no other means for measuring satellite drag and thus deducing air density in the upper atmosphere approached the sensitivity of O’Sullivan’s little inflatable balloon.²⁶

The “Sub-Satellite”

The panel’s approval gave O’Sullivan’s air-density experiment only the right to compete for what little space remained on the Vanguard launching rocket; it did not guarantee that the experiment would ever be flown. The sole allotment of space remaining in the payload amounted to a few cubic inches of space in an annular or ring-shaped area between the head end of the third stage of the rocket motor and the placement of an IGY magnetometer satellite developed by the NRL. Into these cramped quarters, O’Sullivan

and his helpers at Langley would have to squeeze their satellite, along with its inflation mechanism and surrounding container. All of it together could be no more than 20 inches in diameter or a mere seven-tenths of a pound. Because it was so little and was to be carried into orbit underneath the magnetometer satellite, O'Sullivan named the small inflatable vehicle the "Sub-Satellite."*

Although the USNC/IGY technical panel designated O'Sullivan as the principal experimenter for the balloon project, too many problems had to be solved in too short a time for one man to do all the work alone. Therefore, in the fall of 1956, Floyd Thompson authorized the formation of a small team of engineers and technicians, mostly from PARD, to assist O'Sullivan in the preparation of the satellite project. Administratively, Thompson facilitated this in late December 1956 by appointing O'Sullivan as head of a new Space Vehicle Group placed inside PARD. The group would report directly to the division office, which was headed by Joseph A. Shortal. Jesse L. Mitchell of the Aircraft Configurations Branch and Walter E. Bressette from the Performance Aerodynamics Branch of PARD would assist O'Sullivan. Significantly, this small Space Vehicle Group was the first organizational unit at Langley to have the word "space" in its title.²⁷

First, the Space Vehicle Group tested dozens of plastic and metal foils (even gold) in search of the right combination to withstand the extreme range of temperatures that the little satellite would encounter: from 300°F in direct sunlight to -80°F when in the shadow of the earth. The group found half of the answer to the problem in a new plastic material called "Mylar." Made by E. I. du Pont de Nemours & Co., Mylar was being used for recording tape and for frozen-food bags that could be put directly into hot water. When manufactured in very thin sheets, perhaps only half as thick as the cellophane wrapper on a pack of cigarettes, Mylar plastic proved enormously tough. It showed a tensile strength of 18,000 pounds per square inch, which was two-thirds that of mild (low-carbon content) steel.

The second half of the answer, that is, an effective metal covering for the plastic that could protect the satellite from radiation and make it visible to radar scanners, proved a little more difficult to find. For more than a month, the O'Sullivan group "tested metal after metal, looking for ways to paint them on Mylar in layers far thinner than airmail onionskin paper."²⁸ Then, one man in the Space Vehicle Group heard about a technique for vaporizing aluminum on plastic that the Reynolds Metals

* An interesting and seemingly appropriate name, it nonetheless turned out to be problematic technically, because of confusion with the term "subsattellite point," a term from orbital mechanics that defined the point of intersection where a straight line (known as the "local vertical") drawn from a satellite to the center of the body being orbited (in this case, the earth) cuts through the surface of that body. The confusion would grow worse in the late 1960s when the term "subsattellite" came to be used to describe small artificial satellites ejected from other satellites or spacecraft, such as those released from Apollo 15 in 1971 and Apollo 16 in 1972 for the purpose of carrying out certain scientific experiments.

Spaceflight Revolution

To determine the capacity of the 30-inch "Sub-Satellite" (right) to withstand the high temperature of direct sunlight in space, Langley researchers subjected it to a 450° F heat test (below). Results indicated that the aluminum-covered Mylar plastic would effectively reflect the dangerous heat.



L-57-3113

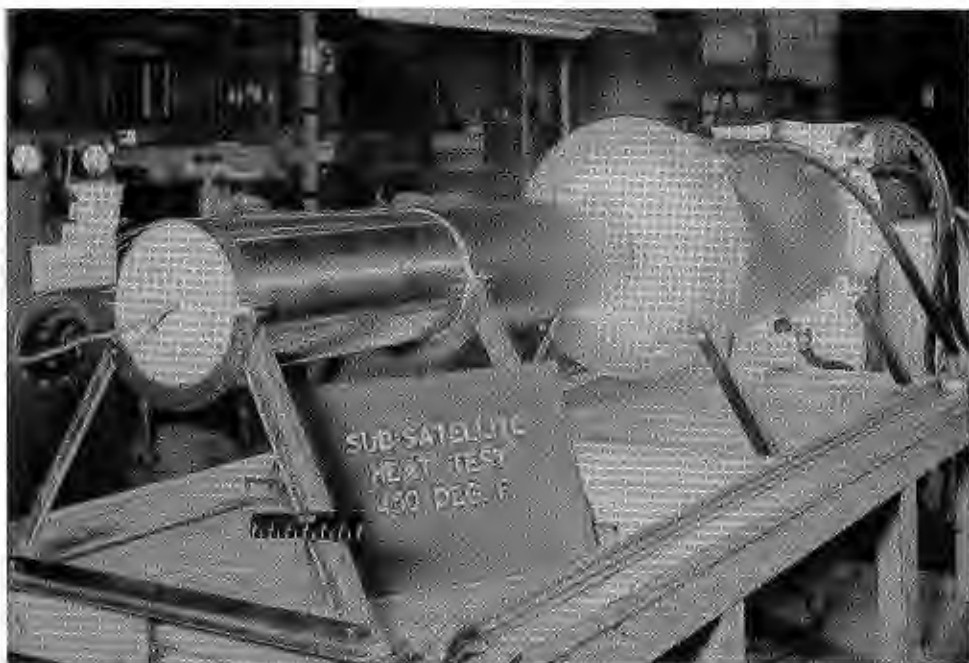

L-58-4293

Company of nearby Richmond, Virginia, was experimenting with for the development of everyday aluminum foil. This new and unique material was acquired and successfully tested. The fabrication problem was solved by cutting the material into gores, that is, into three-cornered or wedge-shaped pieces, and gluing them together along overlapping seams. Using this technique with this material, the Langley researchers built the outer skin of their first 20-inch domes for inflation tests.

Almost everyone involved was excited by the prospect of sending the experiment into space, and several individuals worked nights and weekends through the last months of 1956 to get the Sub-Satellite ready. The right blend of materials had been found for the inflatable sphere; now, two major problems remained: how to fold the sphere so that it could expand quickly without a single one of its folds locking up and causing a tear, and how to inflate the balloon. As for the means of inflation, the Langley researchers tried dozens of strange chemicals before discovering that a small bottle of nitrogen would inflate the little balloon, at the proper rate, so that the sphere would not blow apart. Learning how to fold the satellite was also a purely empirical process; no theory existed to guide the group. As one observer remembers, "Harassed by O'Sullivan, men who couldn't fold a road map properly found a way to fold his aluminum balloon."²⁹

However, this characterization gives O'Sullivan too much credit. Walter Bressette and Edwin C. Kilgore were the engineers who actually worked out not only the folding pattern but also the ejection method and inflation bottle pressure for the Sub-Satellite. Bressette, an airplane pilot in World War II and a 1948 graduate in mechanical engineering from Rhode Island College (now the University of Rhode Island), had spent the last 10 years working on ramjet propulsion systems, jet effects on airplane stability, and reentry problems using both rocket-propelled vehicles and a supersonic blowdown tunnel at Wallops Island. Kilgore, a 1944 engineering graduate from Virginia Polytechnic Institute and State University, had proved to be one of Langley's top machine designers. The two men conducted many trials in a small vacuum chamber in the PARD shop before solving the Sub-Satellite's problems. In addition, Bressette made frequent trips to the NRL in Washington to put the Sub-Satellite package through what he called "the shake, rattle, and roll" of vehicle environmental tests.³⁰

By January 1957, the Sub-Satellite was almost ready. A front-page article appearing in the Langley *Air Scoop* on 5 January touted the little satellite for having originated at Langley, credited O'Sullivan with "having conceived the novel manner of construction," and told employees to look forward to its impending launch. Next to the article was a photograph of O'Sullivan holding in his right hand the shiny inflated Sub-Satellite, the emblem of the NACA wing on its side, and in his left hand, a folded uninflated Sub-Satellite.³¹

However, just when everything was proceeding on schedule, a complication developed. The Baker-Nunn precision optical tracking cameras at

Spaceflight Revolution

White Sands would not be able to follow and photograph such a small sphere; Fred Whipple urged O'Sullivan and the NACA to increase the size of the Sub-Satellite from 20 to 30 inches in diameter. The Sub-Satellite could not weigh more or take up more space on the Vanguard; it just had to be 10 inches bigger. On 7 February 1957, Whipple's panel made this request official, reconfirming assignment of the NACA experiment on Vanguard if the change was made. O'Sullivan believes that the new size requirement "would have been a deathblow to the Sub-Satellite had it occurred at the start"; however, with the experience gained at Langley through actually building the sphere, the increase to a 30-inch diameter was accomplished over the next few months without too much trouble.³²

After all Langley's work, the Sub-Satellite was finally on the launchpad at Cape Canaveral on 13 April 1959. Seconds after takeoff, the second stage of the Vanguard SLV-5 vehicle experienced a failure that sent the rocket and the Sub-Satellite crashing ignominiously into the depths of the Atlantic Ocean. With this launch failure, the attempt to determine air density with the Sub-Satellite came to an end. (This was Vanguard's third attempted launch.) However, other models of the 30-inch sphere were used for a short time both before and after the SLV-5 misfire as a calibration target for a new long-range radar being developed at MIT's Lincoln Laboratory at Millstone Hill Radar Observatory in Westford, Massachusetts.³³

Something the Whole World Could See

Even before the Sub-Satellite's fatal plunge into the ocean in April 1959, O'Sullivan had started to contemplate the benefits of a larger reflector satellite that could be the sole payload on a Vanguard. In November 1957, Fred Whipple presided over a space science symposium in San Diego, which was sponsored jointly by the air force and Convair Astronautics. At this symposium, O'Sullivan proposed that a large inflatable launched by a rocket more powerful than Vanguard could be used as a lunar probe. "It could be seen and photographed through existing astronomical telescopes, not only giving conclusive proof to everyone that such a probe had reached the moon, but its location as it orbited the moon or impacted on the moon would be known." Before sending a balloon to the moon, however, O'Sullivan felt that something must be put into earth orbit, perhaps a 12-foot-diameter satellite, which "the whole world could see."³⁴

For a professional engineer, O'Sullivan was something of a universalist. He worked on airplanes, missiles, and satellites; he knew aerodynamics, and he knew space. But he was not gracious about sharing credit. The idea for the 12-foot satellite was not O'Sullivan's but Jesse Mitchell's. An analysis performed by Mitchell had indicated that a 30-inch-diameter sphere would not make a suitable optical device for a lunar probe; the sphere would have to be several times larger. So in the summer of 1957 while O'Sullivan was away

The Odyssey of Project Echo



L-58-393a

Space Vehicle Group engineer Jesse Mitchell examines the Sub-Satellite package in early October 1958, only days after NASA's establishment. Mitchell, who would later become head of the Geophysics and Astronomy Division at NASA headquarters, directed Langley's program development plan for Echo 1.

from Langley, Mitchell and Bressette had consulted the model shop about building a larger sphere. The size of the sphere became 12 feet because of the ceiling height in the model shop, not because O'Sullivan had determined it to be the perfect size.³⁵

For millions of people, the spaceflight revolution began the first time they looked up in wonder at the bright twinkling movement of an artificial satellite. O'Sullivan was aware of this when he proposed his 12-foot inflatable. With the appearance of *Sputnik 1* a month earlier in October 1957, people around the world, especially Americans, developed a heightened if not exaggerated interest in searching the sky for UFOs. A widespread interest in UFOs had existed before the ominous overflights of the Russian satellites. As historian Walter McDougall explains in his analysis of the onset of the space age, 10 years prior to the first Sputnik, "beginning in the midsummer of 1947 the American people began to see unidentified flying objects, kicking off a flying saucer 'epidemic' of such proportions that the air force launched a special investigation and began compiling thousands of case studies that, in the end, satisfied no one."³⁶ The cause of the epidemic was the new need of Americans to externalize their postwar fears about technology, about the atomic bomb, and about nuclear war destroying the world.

Spaceflight Revolution

Into the blackness of that anxiety-ridden mass psychology came the specter of Sputnik. Across the United States, people went outside with binoculars and telescopes, straining to see the faint blinking reflection of the tiny yet ominous metal globe tumbling end over end. For instance, in San Francisco on Friday night, 4 October 1957, volunteer crews of amateur astronomers with special “moon-watch” telescopes maintained a vigil atop the Morrison Planetarium in Golden Gate Park in hopes of sighting the Russian satellite. Crew members took up their prearranged stations as soon as reports of the satellite’s launching were received. Six tireless individuals continued the lonely vigil until morning, when conditions for viewing were allegedly at their best. How many people actually spotted the satellite that night and over the next several months as it moved in its north-to-south orbit is unknown, but certainly far fewer saw *Sputnik 1* than said they did.³⁷

On that same evening in early October on a large ranch in Texas, Senate Majority Leader Lyndon B. Johnson was having a few guests in for dinner when the news of *Sputnik 1* came over the radio and television. After eating, the party went outside rather nervously for what was supposed to be a calming stroll in the dark along the road to the Padernales River. But the walk only unnerved them. As one of the guests, Gerald Siegel, a lawyer with the Senate Democratic Policy Committee, remembers thinking at the time: “In the Open West you learn to live closely with the sky. It is a part of your life. But now, somehow, in some new way, the sky seemed almost alien. I also remember the profound shock of realizing that it might be possible for another nation to achieve technological superiority over this great country of ours.”³⁸

On the Atlantic coast, among the millions of people all over the country and the world who were looking up in the sky that night to see Sputnik were O’Sullivan and his colleagues at NACA Langley. Bob Gilruth recalls seeing the satellite from his bayside home in Seaford, Virginia. In Gilruth’s words, the sighting “put a new sense of value and urgency” on everything he and his co-workers were doing at Langley. Charles Donlan also remembers sighting the little satellite: “I was running around my yard in Hampton one evening, when I looked up and saw Sputnik go right over my house. I remember stopping and staring at it. What I remember thinking was how much better it would be if the thing belonged to America.”³⁹

Everyone involved with decisions regarding U.S. satellites, including the State Department and the Central Intelligence Agency (CIA), felt the same way. In the wake of the Sputniks, virtually all government officials concerned expressed a desire to orbit a satellite that would be visible over Russia as well as the United States. O’Sullivan’s 12-foot inflatable sphere seemed to fit the bill. Because of shocking world events, what had started out as a simple air-density experiment was becoming an instrument of propaganda in the cold war.

The idea for an inflatable sphere big enough for everyone to see received high priority. Whipple and other members of the USNC/IGY Technical

The Odyssey of Project Echo

Panel on the Earth Satellites expressed serious interest in O'Sullivan's proposal for a bigger inflatable, but they had to wait a few months to see whether a booster more powerful than the Vanguard rocket could be obtained. Finally, in the spring of 1958, the USNC/IGY informed the NACA that some space was available inside the nose cone of a Jupiter C, an intermediate-range ballistic missile developed by the ABMA that was more powerful than the Vanguard rocket. If the Jupiter failed, and of course none of these boosters had yet proved reliable, a Juno II, a new vehicle similar to the Jupiter C, might be available as the backup. A Juno II would launch America's first successful lunar flyby, *Pioneer 4*, on 3 March 1959.⁴⁰

The NACA agreed to the project, and the Space Vehicle Group continued to construct and test its 12-foot inflatable.⁴¹ Because it was to orbit at 300 to 400 miles above the earth and thus would appear as bright as the north star, Polaris, the satellite eventually came to be called "Beacon." Beacon would be easy to see with the naked eye and so could be tracked optically and photographically without difficulty. Big new radars, such as the one being developed by MIT at Millstone Hill,* were just coming on line and would be able to track day or night, regardless of the weather.⁴²

On 25 June 1958, the USNC/IGY officially assigned the 12-foot Beacon satellite as a payload for the launch of Jupiter C No. 49. To obtain the difficult orbit that O'Sullivan insisted on—it was circular rather than elliptical—the Jupiter C had to have a small "high-kick" rocket motor that gave an extra boost to help the satellite reach the desired orbit. Unfortunately, on 23 October 1958, the "high-kick" did not get a chance to "kick in," because the "low kicks" kept failing. As was the case with its 30-inch ancestor, the Beacon was not launched into orbit from Cape Canaveral because the booster failed. Fourteen months later, Juno II No. 19 was ready to carry a second 12-foot satellite into orbit but failed to do so when the rocket's fuel supply emptied prematurely.⁴³

With three failures in a row, O'Sullivan and the Space Vehicle Group might have given up on the balloon if not for the spectacular successes of *Explorer 1* on 31 January and *Vanguard 1* on 17 March 1958. These American satellites proved not only that Americans could put an object in orbit but also that those objects, tiny as they were, could disclose great scientific discoveries such as the Van Allen radiation belts. Beyond that, satellites could be of tremendous economic and social benefit. They could make continuous worldwide observation of the weather possible, and the existence and the likely paths of hurricanes and other destructive storms would be accurately predicted. By studying the development of the world's weather patterns from space, humans might someday control the climate. In summary, satellites offered too many far-reaching benefits for researchers to allow a few launch vehicle failures to discourage them. Rockets were still

* On 3 June 1959, Millstone Hill would transmit a voice message from President Eisenhower and reflect it off the moon to Prince Albert in Saskatchewan, Canada.

Spaceflight Revolution

In July 1959, William J. O'Sullivan (right, standing) and an unidentified engineer examine the capsule containing the tightly folded and packed 12-foot-diameter Beacon satellite (below).



L-59-2836



L-59-4973

in their infancy, in the “Model-T” stage of technical evolution. Failures were to be expected, Langley’s team consoled itself. All the problems had been with the boosters, not with their own satellites.⁴⁴

According to O’Sullivan, he set an example of grit and determination for the rest of his people, many of whom were still quite young. As he told a magazine writer at the time, he was “mindful of his research associates who had labored so hard” to produce the experiments and who “looked to me as their leader.” This was driven home to him, he told the writer, during the unsuccessful launch of the 12-foot satellite. Watching the Doppler velocity drop off rather than climb, he knew instantly the launching rocket had failed. Turning to his associates, he said, “The launching is a failure.” Standing dumbfounded, staring at O’Sullivan, one of them asked, “What do we do now?” O’Sullivan immediately answered, “We pack up our instruments and equipment as quickly as we can. We haven’t a moment to lose. We have to get back to the Laboratory and get the next satellite ready for launching.” When his men started moving in a hurry, O’Sullivan informed the writer, he knew for sure that he “must never waiver or hesitate no matter how stunning the blow.”⁴⁵

According to other key individuals involved with the project, however, O’Sullivan was not the leader he claimed to be. Walter Bressette remembers that “O’Sullivan never went to the satellite launch areas.” In fact, he gave



L-58-88a



L-58-1063a

The genius of William J. O'Sullivan (left) rested in the theory stage of an engineering development; other Langley researchers took over the main responsibility during the design and deployment phases. Walter Bressette (right) played a major role in the Echo program from start to finish. Here he examines a scaled prototype of the satelloon in December 1958.

up direction of the 12-foot satellite mission immediately after the Juno II failure, handing it over to Claude W. Coffee, Jr., and Bressette, who then made the 12-foot Scout proposals. O'Sullivan abandoned his project, leaving it to others to carry on. Those who did continue the work view O'Sullivan's self-publicized heroic role in the eventual success of the effort as egotistical and inaccurate.⁴⁶

Big Ideas Before Congress

Up to the point of the Juno II failure, Langley's interest in inflatable satellites had been limited to air-density experiments in the upper atmosphere and to orbiting an object large enough to be seen by the naked eye; the notion of deploying satellites for a worldwide telecommunications network like the one suggested by John Pierce and Arthur Clarke had not yet taken hold as an immediate possibility.

But the flight of the Sputniks emboldened conservative researchers. In the spring of 1958, as plans for NASA were being formulated in Washington, communications satellites or "comsats" became a moderately hot topic. Not surprisingly, even the NACA began to take a healthy interest in them. At

Spaceflight Revolution

Langley, an advance planning committee recommended that the center begin a comprehensive study of radio-wave propagation and channel requirements, as well as the requirements for active relays. In a decision that would later come to haunt them, the planning committee resolved that the first flight experiment should involve only a simple passive reflector, one in which the satellite acted merely as a mirror and retransmitted only those signals it received. That sort of simple experimental communications satellite could be placed in orbit very soon, perhaps as early as fiscal year 1959, the Langley planners stated. The greater difficulties of building an active system were being tackled elsewhere. A passive flight experiment would demonstrate the feasibility of a space-based system, and the new NASA could accomplish the task largely on its own, without extensive help from industrial contractors, notably Radio Corporation of America (RCA), American Telephone and Telegraph (AT&T), and General Electric (G.E.), who at that time were petitioning the federal government to invest in their own special comsat projects.⁴⁷

Throughout the spring and summer of 1958, Congress listened to arguments about the potential of space exploration and what should be done to ensure that the country's nascent "into space" enterprises would continue far beyond the end of the IGY. This testimony, in part, was the genesis of NASA. The NACA's director of research, Hugh Dryden, testified more than once on Capitol Hill. Before the House Select Committee on Science and Astronautics on 22 April, Dryden explained, among many other things, how large aluminized balloons could be inflated in orbit and used for communication tests. Accompanying him on this occasion was O'Sullivan, who took a full-size Beacon satellite into the Capitol and inflated it there "to demonstrate the structural, optical, and electronic principles involved." In his testimony, O'Sullivan delighted the congressmen by saying, quite emphatically, that Langley had been studying the problem of communications satellites for several months and that its staff was absolutely convinced that a very large inflatable reflecting sphere, at least 10 stories high, could be built quickly and launched into space. This big balloon "would reflect radio signals around the curvature of the earth using frequencies not otherwise usable for long range transmission, thus mostly increasing the range of frequencies for worldwide radio communications and, eventually, for television, thus creating vast new fields into which the communications and electronics industries could expand to the economic and sociological benefit of mankind."⁴⁸

The ideas of Pierce and Clarke were finding a home at, of all places, a government aeronautics laboratory. On 31 March 1958, some three weeks before Dryden and O'Sullivan testified in Washington, John W. "Gus" Crowley, Dryden's associate director, had visited Langley and told Floyd Thompson, O'Sullivan, Joseph Shortal, and others that Dryden had been having conversations with Dr. Pierce of Bell Telephone Labs and with members of President Eisenhower's Science Advisory Committee about

the potential of a global telecommunications system based on satellites. What NACA headquarters now wanted to know, Crowley said, was whether Langley was interested in constructing a larger 100-foot inflatable sphere, on a tight schedule, to be used as an orbital relay satellite like that envisioned by Pierce.⁴⁹

O'Sullivan assured Crowley a few days later that his Space Vehicle Group was "not only interested but enthusiastic about the possibility of placing such a satellite in orbit, and that the schedule could be met." On 3 April 1958, a follow-up meeting took place at Shortal's PARD office to consider designs for the big balloon. At this meeting, O'Sullivan, adopting Jesse Mitchell's scheme, suggested using the 100-foot sphere as a lunar probe. On 18 April, Langley submitted to NACA headquarters a proposed research authorization entitled, "A Large Inflatable Object for Use as an Earth Satellite or Lunar Probe." The NACA did not formally approve the proposal until 8 May, but work on the big sphere had actually started at Langley on a high-priority basis even before Crowley's visit.⁵⁰

In early February 1959, Project Echo, as O'Sullivan had begun to call it, cleared another major hurdle when NASA headquarters assured Langley that an allotment of space would be devoted to the large inflatable in a forthcoming "space shot." Following this authorization, on 19 February, Langley Assistant Director Draley approved the creation of a large interdisciplinary "task group" of approximately 200 people, assigned on a temporary basis without change of organization and initially under O'Sullivan's leadership. The Space Vehicle Group alone could not handle the entire work load, which at this point still involved the 30-inch Sub-Satellite and the 12-foot inflatable. Significantly, as befitting a project that had to succeed, Draley announced that the move was necessary to meet an "emergency." He informed the directorate that "for the duration of this emergency condition," O'Sullivan's Space Vehicle Group and Clarence L. Gillis's Aircraft Configuration Branch, both of PARD, "will merge and work as one unit" with O'Sullivan as head and Gillis as his deputy. To make room for the work load in this merged group, "it may be necessary to postpone, or transfer to other units, some of the work now in progress." In other words, Project Echo took priority over business-as-usual, and everyone at Langley would just have to adjust.⁵¹

Assigning Responsibilities

The first planning meetings for Project Echo convened at NASA headquarters in the summer of 1959, not long before the first NASA inspection. At the second of these meetings, on 13 October 1959, Leonard Jaffe, chief of NASA's fledgling communications satellite program and director of one of the program offices in the Office of Space Sciences at NASA headquarters, surprised Langley representatives by announcing that the "primary responsibility" for managing Echo was being given, not to Langley, but to Goddard,

Spaceflight Revolution

which was still under construction in Greenbelt, Maryland. Various parties would contribute to the project through expanded in-house activities and some extensive contracting, Jaffe explained. The Douglas Aircraft Company plant in Tulsa (a converted B-24 factory) would provide the assembled booster, a three-stage Thor-Delta (later it would be called just a Delta); Bell Telephone Laboratories, where comsat pioneer John Pierce worked as director of electronics research, would make available at Holmdel, New Jersey, a 20×20 -foot horn-fed parabolic receiver, a 60-foot antenna, as well as amplifiers, demodulators, and other electronic and radar equipment; RCA would provide the radar beacon antenna for incorporation upon the Echo spheres; NRL would use its large 60-foot dish antenna at Stump Neck, Maryland, to receive the reflected signals from Echo; and JPL would employ its two 85-foot low-noise antennae at the Goldstone (California) Receiving Site to track the satellite.⁵²

Naturally, Langley was quite disturbed over the assignment of the overall responsibility to Goddard. As one senior Langley researcher remembers, "Echo was considered to be but the first in a long series of large satellite experiments under the jurisdiction of Langley." If Langley lost Echo to Goddard, all the other large satellite experiments would probably go to Goddard as well. Whatever proved to be the case, however, Langley felt that Jaffe's instructions need not have any immediate effect on Echo. Langley, both through in-house work and the monitoring of contracts, would keep the responsibilities for the key research and development tasks. These tasks were not spelled out precisely by Jaffe at the planning meeting, and more than a year would pass before a working agreement satisfactory both to Goddard and Langley was finalized. Even after the agreement was reached in January 1961, relations between the two NASA centers were stressful. As we have seen, tensions already existed between them. Goddard staff wanted to exercise management authority over a project they felt was rightfully theirs; Goddard was the center for all NASA space projects. As the originators of the Echo concept, O'Sullivan and his associates saw Goddard as an intruder. Langley researchers, therefore, planned to ignore Goddard and continue working as before the reassignment.⁵³

Pending the final agreement over the division of responsibilities, Langley's Project Echo Task Group continued to do whatever it felt needed to be done to assure the success of the "satelloon."* This included doing virtually all

* Langley could proceed independently of Goddard in part because of the manner in which NASA managed Echo and provided funding to Langley for the project. With its establishment as an official NASA spaceflight project, responsibility for managing Echo went to the Office of Space Flight Development under Abe Silverstein, who then assigned the project to the Office of Space Sciences, wherein Leonard Jaffe, the chief of communications satellites, took over the regular responsibilities. Funding for Echo came from Silverstein's bailiwick, through Jaffe's office, and then made its way to Langley via transfers from Bob Gilruth's STG. For a time, O'Sullivan's entire Space Vehicle Group was carried on the personnel rolls of the STG. In effect, this convoluted but cozy arrangement meant that

of the preliminary design for the payload, including the satellite itself; the satellite container with all its associated circuitry, hardware, and pyrotechnics; the container-separation or deployment mechanism; and the inflation system. The Langley group developed the techniques for fabricating, folding, packing, and inflating the rigidized sphere, and it carried out the systematic ground tests to make sure that everything worked properly. After completing the ground tests, Langley also assisted in all launches and test flights.

Nonetheless, as the Langley engineers involved would soon discover, the assignment of Project Echo to the Goddard Space Flight Center was the initial step in the demise of the development of any passive communications satellite system. The Goddard director had already heavily committed his resources to the development of an active system; his organization was thus reluctant to take on the added burden of the passive system, which many Goddard engineers, and probably Goddard Director Goett, believed would prove inferior.

Shotput

One of the responsibilities taken on by Langley in early 1959 was the management of a project essential to Echo's success: Shotput. The purpose of Shotput was "to ensure proper operation of the payload package at simulated orbital insertion"—in other words, to do thorough developmental testing of the techniques by which the folded Echo balloon would be ejected from its canister and inflated in space. The techniques conceived and refined for the Sub-Satellite and the 12-foot Beacon satellite were almost totally inapplicable to the giant Echo balloon, so new schemes had to be perfected. Only some of the critical tests could be made on the ground because a vacuum chamber large enough to simulate the complete dynamics of the balloon inflating in space was impractical to build. The only option was to do the testing in the actual environment of space, and that meant developmental flight tests.⁵⁴

The importance of Shotput to Project Echo's ultimate success bears witness to the need for thorough developmental testing prior to any spaceflight program. Before NASA researchers risked an expensive launch of a precious piece of space hardware, they made sure that the project would work from start to finish. Langley's plan was to flight-test suborbital Shotput vehicles from Wallops Island, then conduct as many orbital launches from Cape Canaveral as needed to put an Echo satellite in orbit successfully. For the most part, that plan was followed.

the part of Langley working on Echo was really working for the Office of Space Flight Development under Silverstein. But it also meant that the Langley Project Echo Task Group relied not on Goddard, but on Langley's Procurement Division for its funding. See Joseph A. Shortal, *A New Dimension: Wallops Flight Test Range, the First Fifteen Years*, NASA RP-1028 (Washington, 1978), p. 688.

Spaceflight Revolution

One of the most difficult technical tasks facing Langley researchers working on Project Echo was designing a container that would open safely and effectively release the satelloon. After several weeks of examining potential solutions to this problem, the Langley engineers narrowed the field of ideas to five. They then built working models of these five container designs, and 12-foot-diameter models of the satellite for simulation studies. With help from Langley's Engineering Service and Mechanical Service divisions, the Echo group built a special 41-foot-diameter spherical vacuum chamber equipped with pressure-proof windows. There the dynamics of opening the container and inflating the satelloon could be studied as the satelloon fell to the bottom of the tank. To observe and photograph the explosive opening and inflation within the dark chamber, a special lighting rig had to be devised. Employing heavy bulbs enclosed in protective housings, the rig ensured that in the short time the test required, the bulbs would not overheat or be shattered by a shock wave.⁵⁵

The container-opening mechanism that eventually resulted from these vacuum tests was surely one of the oddest explosive devices ever contrived. The container was a sphere that opened at its equator into top and bottom hemispheres. The top half fit on the bottom half much like a lid fits snugly atop a kitchen pot. The joint between the two hemispheres, therefore, formed a sliding valve. The halves had to move apart an inch or two before the canister was actually open. It was in this joint between the hemispheres that the charge was placed.

The charge was incased in a soft metal tube that encircled the canister; in cross section, the tube had the shape of a sideways V. This shape concentrated the blast into a thin jet that shot out the mouth of the V. When the charge had been placed, Langley technicians fastened the hemispheres of the container together. Because even minimal pressure remaining inside the canister would be greater than that in space, the team had to take steps to prevent the canister from blowing apart too soon. The solution was to lace fishing line through eyelet holes in the hemispheres. When the explosive charge fired out, the resulting jet cut the lacing so that the container halves were free to separate. At the same time, pressure from the charge drove the hemispheres apart, releasing the balloon.

This ingenious arrangement proved successful despite its inelegance. So pleased were the Langley researchers with their invention that they were "somewhat taken aback" when visiting scientists and engineers, hearing descriptions of a container-opening mechanism involving such crazy things as a pot-lid sliding valve and a lacing made of fishing line, "thought we were joking."⁵⁶

As challenging as the opening of the satelloon container was, the problem of inflating the large satelloon without bursting it was even more vexing. O'Sullivan once explained the crux of the matter: "When the satelloon container is opened to release the satelloon in the hard vacuum of space, any air inside the folded satelloon or outside of the satelloon between its

The Odyssey of Project Echo



L-64-6971

A technician assigned to the Project Echo Task Group separates the two hemispheres of the Echo 1 container for inspection. The charge that freed the balloon was placed inside of a ring encircling the canister at its equator.

folds tends to expand with explosive rapidity and rip the satelloon to pieces. But this understanding of the problem was not easily acquired, for there is no vacuum chamber on earth big enough and capable of attaining the hard vacuum of space, in which the ejection and complete inflation of the satelloon could be performed and the process photographed with high speed cameras to detect malfunctionings of the process.”⁵⁷

Before risking the launch of a balloon into space, the Project Echo Task Group determined that it should first conduct a static inflation test on the ground to see whether the 100-foot-diameter satelloon would assume a spherical shape with surface conditions sufficient to serve as a passive communications relay satellite between two distant stations on the surface of the earth. To make the static inflation tests, Jesse Mitchell took a team of engineers to nearby Weeksville, North Carolina, off the north shore of the Albemarle Sound, where a cavernous navy blimp hangar big enough to inflate the Echo balloon to full size stood empty. The inflation process was slow, taking more than 12 hours, and thus did not offer a dynamic simulation of the explosive inflation that would take place in space; however, the results did reassure everyone that the balloon would work as a communication relay. As Norm Crabill, present at the Weeksville tests, explains, “It was another one of the tests we had to go through before we could trust the design.”⁵⁸

These tests also demonstrated that the original balloon, manufactured by General Mills, was seriously defective. When the balloon was inflated in the hangar, the triangular panels, or gores, began coming apart at the seams.

Spaceflight Revolution

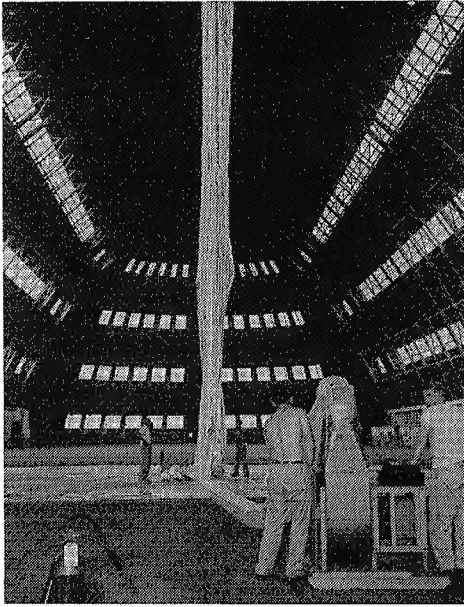

L-58-3598

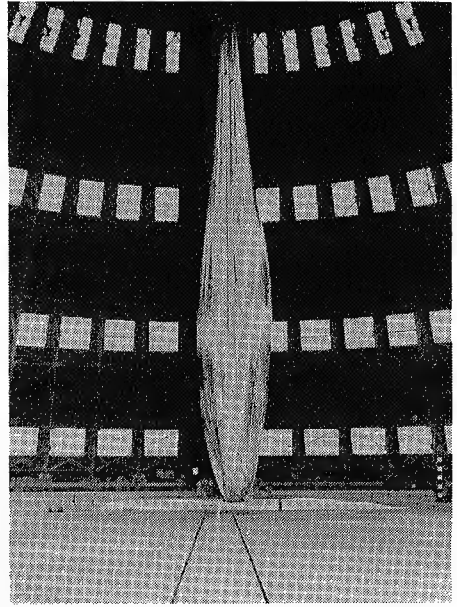

L-B



L-F



L-58-3600

Testing Echo 1's inflation (above) in the navy hangar at Weeksville took half the day but proved worth the trouble.

The Odyssey of Project Echo



L-58-3603

Langley engineers Edwin Kilgore (center), Norman Crabill (right), and an unidentified man take a peek inside the vast balloon during inflation tests.



L-61-4603

The Echo 1 team stand in front of their balloon. William J. O'Sullivan is the tall man at center; Walter Bressette is to his left.

Spaceflight Revolution

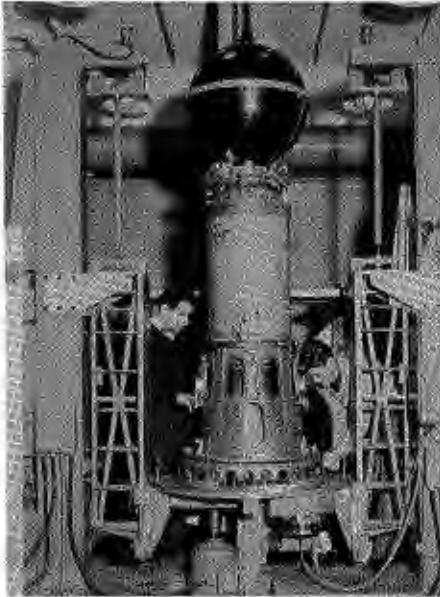

L-60-490



L-60-485

Langley technicians Will Taub and James Miller (left) prepare to spin-balance the final stage of the Shotput launch vehicle. The ABL X248 motor sits on the spin table; the balloon-containing canister is at the top. When the Shotput was fully prepared for launch (right), a pencil-shaped shroud was fitted over the payload.

Another manufacturer, the G. T. Schjeldahl Company of rural Northfield, Minnesota, had a glue perfect for sealing the seams, so General Mills hired the company to construct a second sphere. The proud Schjeldahl Company provided all subsequent inflatable spheres for NASA.⁵⁹

Although the ground testing proved critical, the only sure way to test the inflation process was to launch the sphere in its container up to satellite altitude. To do this, members of the Project Echo Task Group designed the special two-stage test rocket called "Shotput." This, they thought, was the perfect nickname for a vehicle that would essentially hurl a big ball out of the atmosphere.

Shotput's first stage was the Sergeant XM-33; its second stage was the ABL (Allegheny Ballistics Laboratory) X248. The latter also served as the third stage of the Douglas Thor-Delta, soon to be one of the United States' primary satellite launchers. Although the test program's main purpose was to check out the Echo satelloon, testing this part of the Thor-Delta became a critical secondary task. The ABL X248 stage included a solid-propellant rocket motor designed to achieve proper satellite velocity and altitude. The motor was spin-stabilized, so after it had burned out and the motor-satellite complex had entered orbit, the whole ensemble had to be de-spun before the satellite could be separated. To accomplish that, engineers fashioned a

weighted mechanism known as a “yo-yo,” which stopped the spinning and allowed the container to separate safely.⁶⁰

Solving the problems of the launch vehicle was as difficult as solving the problems of the balloon. Norm Crabill traveled back and forth to Tulsa several times to understand the detailed design of the Delta third stage. (O’Sullivan once tried to remove Crabill from the project because he thought the young Langley engineer did not know enough to be in charge of the development of the Shotput test vehicle.) Crabill and his assistant Robert James intensely studied the forces and moments (i.e., the aerodynamic tendency to cause rotation about a point or axis) on the Shotput vehicle as it shot up and out of the atmosphere, spun its way to altitude, and despun for payload separation. The researchers had to assimilate in just a few months what amounted to an advanced course in aerodynamics and missile dynamics, but finally, after numerous analytical studies and simulations, Crabill and his helpers, one by one, solved the problems of launching *Shotput 1*.

A Burst Balloon

By the second Project Echo planning meeting, Langley had established a schedule for four Shotput tests. (Five Shotput launches would in fact occur; the last would take place on 31 May 1960.) Everyone inside NASA, including the interested parties at Goddard, agreed that the responsibility for managing Shotput and launching the vehicles from Wallops Island should remain in Langley’s hands.

Unfortunately, keeping their brainchild at home did not assure total success. As described in this chapter’s opening, the launch of *Shotput 1* on 28 October 1959 started off well, but far above the “sensible” atmosphere, upon inflation, the big balloon blew up. Instead of a respectable scientific experiment, Echo looked more like a Fourth of July skyrocket.⁶¹

Despite the initial subterfuge of calling the test a success and omitting any mention of the balloon’s explosion, the group’s spokesmen finally confessed under pressure from the media and with great embarrassment, “that it was not supposed to work *that way*.” For several weeks thereafter, everyone at Langley became an authority on inflatable satellites, telling O’Sullivan’s associates (not daring to tell O’Sullivan himself, as he was known to have little charity for opinions contrary to his own) what had caused the explosion and how to fix it. Many of these “self-appointed experts” demanded to be heard. The Project Echo Task Group accommodated most of them, trying to keep in mind that “all of these people meant well and were trying to help.”⁶² Thereafter, NASA headquarters also announced the Shotput tests well ahead of time, so that everyone on the East Coast could watch and enjoy them. However, if everything went right with the balloon, the spectacular fireworks would not occur.

Spaceflight Revolution

A 500-inch focal-length photographic camera set up on the beach at Wallops Island had taken pictures of *Shotput 1* as the balloon inflated and blew up, but even with these data a team from the Project Echo Task Group spent several weeks trying to confirm why the balloon had burst apart. Some researchers believed that the water used to help inflate the balloon had been the culprit. Like other volatile liquids, water will boil explosively in the zero pressure of space. It was “entirely conceivable that the elastic containers in which the water was carried inside the satellite might have leaked or ruptured during launch, and thus did not release the water at a slow and controlled rate as planned, to give a slow and gentle inflation.”⁶³ Leaked water could easily have produced an explosion.

To ensure that the water inflation system would not malfunction in the future, the team, led by Walter Bressette, switched to benzoic acid, a solid material that underwent sublimation—that is, transformation from a solid state directly to a vapor. With such a material, conversion to a gas would be limited by the rate at which it would absorb heat from the sun. In essence, it would “gas off” slowly, not instantaneously.

Researchers worried that another contributor to the explosion may have been residual air, which the payload engineers had intentionally left inside the folds of the balloon as an inflation agent. Langley’s O’Sullivan once explained: “When the satelloon container is opened to release the satelloon in the hard vacuum of space, any air inside the folded satelloon or outside the satelloon between its folds tends to expand with explosive rapidity and rip the satelloon to pieces.”⁶⁴ To remove all residual air from future deployments, the engineers made over 300 little holes in the balloon to allow the air to escape after the balloon was folded. Once the balloon was packed, the canister was placed, slightly open, in a vacuum tank. When its internal pressure had been reduced to near zero, the canister was closed, and an O-ring maintained the internal vacuum.

Finally, to better identify deployment problems, the engineers put a red fluorescent powder into the folded-up balloon. If the balloon ruptured during ejection or inflation in subsequent tests, the powder would blow out and leave a trail that could be instantly seen around the satellite even from the earth.

Four Shotputs were launched before the Langley researchers were satisfied that Echo would work. The second shot, on 16 January 1960, failed because of a problem with Crabill’s beloved launch vehicle. The yo-yo de-spin system of the Shotput second stage did not deploy properly, and the payload separated from the burned-out second stage still spinning at 250 rpm. When the red dye appeared in the sky, it was clear that the de-spin failure had caused the balloon to tear while inflating. Following this test, no more serious problems with the launch vehicle occurred; there were only problems with the test balloon. On the third shot five weeks later, on 27 February, the balloon tore and developed a hole, although not before Bell Labs was able to use the sphere to transmit voice signals from its headquarters in Holmdel, New Jersey, to Lincoln Labs in Round Hill, Massachusetts.

A successful shot took place on 1 April, but the tests were still incomplete as the satellite did not yet carry any of the tracking beacons that the final version would have.⁶⁵ (Because Echo's orbit would not be geostationary—hovering over the same spot on earth 24 hours a day—such devices were required to enable ground crews to track the balloon.)

The Project Echo Task Group, however, believed that “they were over the hump” and that the next step was to move beyond Shotput, put the completely equipped 100-foot passive reflector balloon on the Thor-Delta, and attempt a launch. The scheduled launch date of “TD No. 1” from Cape Canaveral was 13 May 1960, just over a month away. Unlike the Shotput tests, whose ABL X248 carried the test balloons only to 200 to 250 miles above the surface, the much more powerful 92-foot-high Thor-Delta would ultimately take the balloon to an orbit 1000 miles above the earth. From there, the enormous Echo would be visible to people all around the world.⁶⁶

“Anything’s Possible!”

The Echo balloon was perhaps the most beautiful object ever to be put into space. The big and brilliant sphere had a 31,416-square-foot surface of Mylar plastic covered smoothly with a mere 4 pounds of vapor-deposited aluminum. All told, counting 30 pounds of inflating chemicals and two 11-ounce, 3/8-inch-thick radio-tracking beacons (packed with 70 solar cells and 5 storage batteries), the sphere weighed only 132 pounds.

For those enamored with its aesthetics, folding the beautiful balloon into its small container for packing into the nose cone of a Thor-Delta rocket was somewhat like folding a large Rembrandt canvas into a tiny square and taking it home from an art sale in one's wallet. However, the folding of the balloon posed more than aesthetic problems. The structure not only had to fit inside the spherical canister but also had to unfold properly for inflation.

The technique for folding the 100-foot inflatable balloons evolved from a classic “Eureka” moment. One morning in 1960, Ed Kilgore, the man in the Engineering Service Division responsible for the Shotput test setups, received a call from Schjeldahl, the manufacturer of the Echo balloons. The company's technicians were having a terrible time: not only were they unable to fit the balloon into its canister, they couldn't even squeeze it into a small room.

Kilgore mulled over the problem all day and part of the night, but it wasn't until the next morning that he happened upon a possible solution. “It was raining,” he recalls, “and as I started to leave for work, my wife Ann arrived at the door to go out as I did. She had her plastic rain hat in her hand. It was folded in a long narrow strip and unfolded to a perfect hemisphere to fit the head.” Recognizing the importance of his accidental discovery, Kilgore told his wife that she “would have to use an umbrella or get wet because I needed that rain hat.”⁶⁷

Spaceflight Revolution

At Langley, Kilgore gave the hat to Austin McHatton, a talented technician in the East Model Shop, who had full-size models of its fold patterns constructed. Kilgore remembers that a “remarkable improvement in folding resulted.” The Project Echo Task Group got workmen to construct a makeshift “clean” room from two-by-four wood frames covered with plastic sheeting. In this room, which was 150 feet long and located in the large airplane hangar in the West Area, a small group of Langley technicians practiced folding the balloons for hundreds of hours until they discovered just the right sequence of steps by which to neatly fold and pack the balloon. For the big Echo balloons, this method was proof-tested in the Langley 60-foot vacuum tank as well as in the Shotput flights.⁶⁸

Whether the packed balloon would have deployed properly on 13 May 1961, no one will ever know because once again the launch vehicle failed. The second stage of the Delta refused to fire, and the whole rocket dropped into the Atlantic. The vehicle’s manufacturer, Douglas, blamed a malfunctioning accelerometer.⁶⁹

By this point, the program had experienced a total of seven failures including those of the two small pre-Echo test satelloons. For a test conducted on 31 May, the team returned to using the Shotput launcher. With tracking beacons aboard, the balloon deployed successfully, which helped the NASA engineers rally from their recent setback.

Still, critics continued to doubt the overall Echo concept. Some swore that even if the satelloon ever got up into space and inflated properly, micrometeorites would puncture its skin, thus destroying the balloon within hours. Not so, the Langley engineers countered. The idea was to pressurize the balloon just enough to overstress the material slightly, thus causing it to take on a permanent set. Even after its internal pressure had dwindled to nothing, the balloon would retain its shape. Because the outer skin was not extremely rigid—it was in engineering slang “dead-soft”—it could be punctured by a small meteorite and still not shatter. Finally, a study by Bressette showed that micrometeorites would erode less than one-millionth of the surface area a day. If only a launching and deployment would go right, the satelloon’s sublimating solid-pressurization system would work long enough to enable engineers to conduct their communications experiment.⁷⁰

The next time around, the launch finally did go right. At 5:39 a.m. on 12 August 1960, Thor-Delta No. 2 blasted into the sky from launchpad 17 at Cape Canaveral, taking its balloon into orbit. A few minutes later, the balloon inflated perfectly. At 7:41 a.m., still on its first orbit, *Echo 1* relayed its first message, reflecting a radio signal shot aloft from California to Bell Labs in New Jersey. “This is President Eisenhower speaking,” the voice from space said. “This is one more significant step in the United States’ program of space research and exploration being carried forward for peaceful purposes. The satellite balloon, which has reflected these words, may be used freely by any nation for similar experiments in its own interest.”⁷¹ After the presidential message, NASA used the balloon to

transmit two-way telephone conversations between the east and west coasts. Then a signal was transmitted from the United States to France and another was sent in the opposite direction. During the first two weeks, the strength of the signal bounced off *Echo 1* remained within one decibel of Langley's theoretical calculations.

The newspapers sounded the trumpets of success: "U.S. Takes Big Jump in Space Race"; "U.S. Orbits World's First Communications Satellite: Could Lead to New Marvels of Radio and TV Projection"; "Bright Satellite Shines Tonight." So eager was the American public to get a glimpse of the balloon that NASA released daily schedules telling when and where the sphere could be seen overhead.⁷²

For the engineers from Langley who were lucky enough to be at Cape Canaveral for the launch, this was a heady time. Norm Crabill remembers hearing the report that "Australia's got the beacon," meaning that the tracking station on that far-off continent had picked up the satellite's beacon signal. To this day, Crabill "gets goose bumps just thinking about that moment." He remembers thinking, "Anything's possible!"⁷³ After all, the space age had arrived, and in a sense, anything was.

Reflections

Out of the seven failures, including the scintillating bits of *Shotput 1*, NASA built a successful communications satellite program, which entranced the public. After a fully operational Echo balloon was launched into orbit on 12 August 1960, the big silver satelloon continued to orbit for eight years, not falling back to earth until May 1968. For that entire period, the satelloon served as a significant propaganda weapon for the United States. It was a popular symbol of the peaceful and practical uses of space research, especially in the early 1960s when the country still seemed so far behind the Soviets.

During its long sojourn in space, *Echo 1* proved to be an exceptionally useful tool. First and foremost, by enabling numerous radio transmissions to be made between distant ground stations, it demonstrated the feasibility of a global communications system based on satellites. The rapid and successful development of worldwide communications in the 1960s depended upon this demonstration. *Echo 1* also proved wrong the experts who said that the satelloon, after losing internal pressure because of meteoroid punctures, would collapse from external pressure. Echo actually retained its sphericity far longer than expected, the external pressures (including solar radiation) doing more to change the orbit of the satelloon than to collapse it.⁷⁴ In addition, NASA researchers studied the long-term durability of the unique metallized plastic of the Echo balloons (an *Echo 2* was launched in 1964) in order to evaluate similar materials proposed for components of other spacecraft, including early versions of a manned space station.

Spaceflight Revolution

Finally, Echo permitted scientists to demonstrate a triangulation technique for determining the distance between various points on the earth's surface, thus improving mapping precision. The satelloon also served as a test target for the alignment and calibration of a number of new radars.

However, the Echo satelloon demonstrated some critical limitations. As it turned out, the balloon's shape was a poor passive reflector. When hit with a *plane wave* (a wave in which the wave fronts lay in a fixed line parallel to the direction of the propagation), the sphere tended to propagate the wave outward and reflect it as a *divergent wave*. Echo did an adequate job reflecting radio signals transmitted from the ground, but it did a poor job of focusing them. As a result, everybody received some of the reflected signal, but nobody received very much of it.

Thus, the Echo balloon served primarily as a demonstration model, showing how a simple passive comsat might work. For actual operations, a better concept, which NASA and the companies involved in the development of commercially viable satellites were already working on, was satellites that could communicate with active electronics. Because the force or intensity of a radio wave is weakened or attenuated by the square of the distance it must travel through space, an active communications system has a distinct advantage over the passive system: the active system receives the signal at one frequency and retransmits it at another. In effect, the signal travels the earth-to-satellite distance only once; the signal in a passive system must travel the distance twice, and thus is more seriously attenuated, as the fourth power of the distance.⁷⁵

The demise of the passive satellite communication system and the emergence of the active communication system, however, also need to be explained in the context of broader economic, political, and institutional realities. In the beginning, satellite communications research was funded by the U.S. government because the military required worldwide instantaneous communications for national defense. The military was interested in the passive system because it could not be electronically jammed. On the other hand, the private telecommunications companies were not yet interested in a satellite communications system, partly because they were investing heavily in ground relay stations and under-the-ocean cable systems and partly because their engineers strongly suspected that radio signals passing through the earth's ionosphere would be seriously weakened in intensity.

In an ironic twist of fate, given the history that was to follow, the Echo balloon actually changed this thinking about the potential of a communications system in space. When *Echo 1* demonstrated that the ionosphere was not going to be a problem in satellite communications, the private sector jumped on the bandwagon and demanded their own geosynchronous satellite system, but the private sector wanted an *active* rather than a passive system. Many of the companies involved had the technical knowledge to develop an active system, but this was not the sole reason for their interest; money was another factor. Individual companies could charge for sending a message

through the system since they would own the frequency channels located in the particular satellites. As Bressette comments, "The active communications people used the capitalistic approach for the success of a project: 'Does it make money?' On the other hand, the few people [like Bressette] who were promoting the passive system were thinking more democratically. Just think how inexpensive satellite communications would be today, if it were possible to replace all the active communications satellites with just three nonmaintenance passive satellites."⁷⁶

To overcome the problem of radio-wave attenuation from geosynchronous orbit, the Echo satelloon would need to be many times larger. Since the technology did not exist in the early 1960s to put such a large satelloon in orbit, even the military began to opt for the active system. Given the logistical difficulties and tremendous costs of flying high-altitude radio-relay stations over the oceans inside giant aircraft such as the B-52, the DOD was excited by the promise of a space-based geosynchronous system, which could move the high-altitude radar-relay flights into a backup position.

For its part, NASA Langley did not easily give up on the passive system. Between 1963 and 1965, in conjunction with Goodyear Aerospace Corporation, a team of Langley researchers performed a study showing that as little as a 10° segment cut from a very large sphere in geosynchronous orbit would be satisfactory for passive communications between two remote stations on earth.⁷⁷

William J. O'Sullivan's original concept for the inflatable satellite, which was to serve as an air-density experiment, was not forgotten. The long-term orbiting of the satelloon allowed scientists to measure accurately, for the first time, the density of the air in the far upper atmosphere. With the data came some important insights into the effects of solar pressure on the motion of satellites, information that was helpful in predicting the behavior and lifetime of future satellites. Several versions of the basic experiment were carried out at a high altitude over both low and high latitudes of the earth's surface as part of four Explorer missions: *Explorer 9* in February 1961, *Explorer 19* in December 1963, *Explorer 24* in November 1964, and *Explorer 39* in August 1968. NASA launched these satellites at regular intervals to provide continual coverage of density variation throughout a solar cycle. With the findings from these worthwhile missions, scientists were able to improve their measurements of atmospheric density, better understand variations in density caused by variations in the solar cycle, and study the MPD-related phenomena of geomagnetically trapped particles and their down-flux into the atmosphere.⁷⁸

O'Sullivan's 1956 concept led to not just a single experiment but an entire program of inflatable satellites, all of which involved Langley in some central way. This program included, in addition to the Echo satelloons and the air-density Explorers, a Langley-managed passive geodetic satellite known as "Pageos" (Passive Geodetic Earth-Orbiting Satellite). A Thor-Agena lifting off from the Pacific Missile Range in June 1966 took *Pageos 1*, which was

Spaceflight Revolution

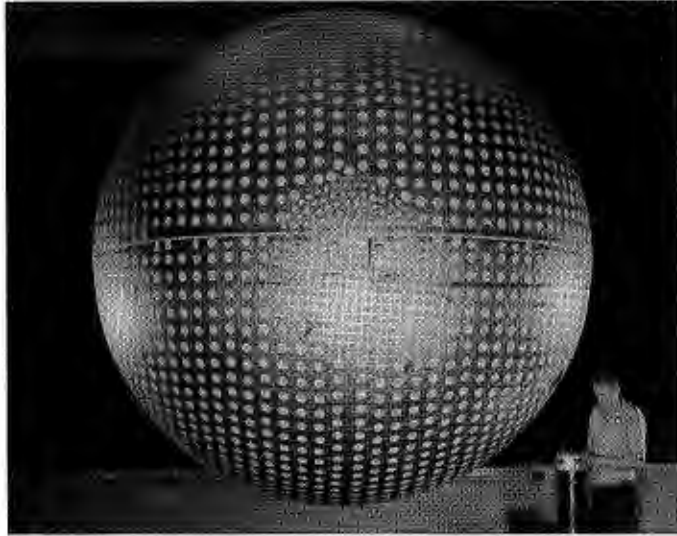

L-64-9269

This satellite, Explorer 24, was a 12-foot-diameter inflatable sphere developed by an engineering team at Langley. It provided information on complex solar radiation/air-density relationships in the upper atmosphere.

very similar to *Echo 1*, into a near polar orbit some 200 nautical miles above the earth. This orbit was required by the U.S. Coastal and Geodetic Survey to use the triangulation technique developed from *Echo 1* for determining the location of 38 points around the world. More than five years and the work of 12 mobile tracking stations, which waited for favorable weather conditions during a few minutes of twilight each evening, were required to complete the project. Finally, the geodetic experts were able to fix the 38 points into a grid system helpful in determining the precise location of the continents relative to each other. Some of this information, that which was not classified as secret, enabled the U.S. scientific community to determine geometrically the shape and the size of the earth. This, in turn, was useful to scientists studying the theory of continental drift. Data that the U.S. Army Map Service classified as secret proved helpful to U.S. military planners concerned with the accuracy of intercontinental ballistic missiles. Thus, although initially conceived to tell us about the upper atmosphere, NASA's inflatable satellite program told us perhaps even more about the military buildup here on earth.⁷⁹

O'Sullivan became one of NASA's most highly publicized scientists. In December 1960, the U.S. Post Office Department issued a commemorative 4-cent stamp in honor of his beloved Echo balloon. For his concept of the inflatable space vehicle, NASA would award him one of its distinguished service medals, in addition to \$5000 cash. In 1962, O'Sullivan would appear as a guest on the popular TV game show "What's My Line?"; all four of



L-65-6894

Hanging from the ceiling of the Weeksville blimp hangar like a shiny Christmas tree ornament, Langley's Pageos satelloon was virtually identical to Echo 1.

the celebrity panelists correctly picked him from the lineup as the father of the Echo satelloons.

As is nearly always the case in the history of a large-scale technological development, however, many other individuals, mostly overlooked, deserved a significant share of the credit. Jesse Mitchell was one of those individuals. In late 1959, Mitchell, who had been responsible for the program development plan for *Echo 1*, left Langley for a special assignment on an important space advisory committee chaired by Dr. James Killian, President Eisenhower's special assistant for science and technology. After this assignment, Mitchell became the head of the Geophysics and Astronomy Division at NASA headquarters. In following years, his office funded the last three air-density satellites and the Langley-managed Pageos geodetic survey satellites.

The Hegemony of Active Voice

Project Echo continued for several more years. In 1962, Langley engineers staged "Big Shot"—two space deployment tests of the *Echo 2*

Spaceflight Revolution

balloon.* The first test was a disaster, with the balloon tearing apart because of a structural load problem. The second test was a success. *Echo 2* was launched into orbit in 1964, serving, like its predecessor, as a passive communications relay. By the mid-1960s, however, the active satellite had proved itself the better method for communications in space. In July 1962, a little more than two years after the launch of *Echo 1* and some 20 years after the publication of Arthur C. Clarke's speculative essay on the potential of "extraterrestrial relays," NASA had launched its first active communications satellite, *Telstar 1*. This experimental "comsat," which belonged to AT&T, sent the first direct television signals ever between two continents (North America and Europe). In December 1962, while Langley and Goddard were still quarreling over what to do with *Echo 2*, NASA's own *Relay 1* satellite went into action. Within days, *Relay 1*, which was developed at NASA Goddard, was transmitting civilian television broadcasts between the United States and Europe. When TV viewers saw astronaut L. Gordon Cooper being recovered from his capsule on 16 May 1963 at the end of the last Mercury mission, they were seeing a signal from *Relay 1*.⁸⁰

The age of the active comsat had arrived, and with it came a revolution in telecommunications that would have an enormous impact worldwide. On 25 February 1963, NASA announced that it was canceling its plans for any advanced passive communications satellites beyond *Echo 2* and cutting off funding for several feasibility study contracts aimed at determining the best shape, structure, and materials of future communications balloons in space. In light of the formation of the national Communications Satellite Corporation (ComSatCorp), the space agency instead would focus its efforts on the development of synchronous-orbit active satellites.⁸¹

The next American active comsat, *Telstar 2*, went into space in May 1963, which was still before the launch of *Echo 2*. *Telstar 2* sent the first color television pictures across the Atlantic Ocean. On 22 November 1963, NASA's *Relay 1* was scheduled to transmit color television pictures across the Pacific. An audience in Japan waited to see a ceremonial meeting between NASA Administrator James E. Webb and the Japanese ambassador in Washington. The audience in Tokyo was also supposed to receive a taped greeting from President Kennedy; instead, *Relay 1* transmitted the shocking news of his assassination. Thanks to *Relay 2*, which was launched in January 1964, TV viewers were able to witness Pope Paul VI's visit later that year

* The management of Big Shot and *Echo 2* proved more quarrelsome than Shotput and *Echo 1*. Langley and Goddard personnel disagreed strongly about many engineering details and fought over budgetary and procurement matters. The Langley engineers were angry that Goddard officials were in charge of *Echo* when Langley was doing the basic planning leading to launch. Goddard's satellite experts, on the other hand, were already involved in the development of active electronic comsats and were not much interested in improving the performance of passive reflectors. Thus, the tug-of-war between Langley and Goddard was more than a turf battle; it was a technical debate between advocates of passive and active satellites.

to the Middle East as well as Soviet Premier Nikita Khrushchev's tour of Poland. Thanks to another NASA-sponsored communications satellite, the Hughes Aircraft-developed *Syncom 3*, Americans enjoyed live TV coverage of the Olympic games taking place on the other side of the world in Tokyo.⁸²

In 1964, 10 nations (plus the Vatican) formed the International Telecommunications Satellite Consortium, or Intelsat. In the next 12 years, Intelsat built something close to the integrated system of global communications that Arthur Clarke had suggested. By the late 1960s, Intelsat's membership included 80 countries. Individual nations owned and operated their own ground stations and reaped dividends in proportion to their investment shares, while a large, new American joint-stock company, ComSatCorp, whose operations were private but heavily subsidized by the U.S. government, managed the financial and operations end of the satellite communications system. (NASA simply launched the satellites and was reimbursed for its costs.) By the early 1970s, Intelsat's sophisticated network was enabling rapid long-distance telephoning and distribution of TV programs as never before. One NASA historian has written, "Before these satellites existed, the total capability for transoceanic telephone calls had been 500 circuits; in 1973 the Intelsat satellites alone offered more than 4000 transoceanic circuits. Real-time TV coverage of events anywhere in the world—whether Olympics, wars, or coronations—had become commonplace in the world's living rooms."⁸³

Arthur Clarke's prophecy of "global TV" and "citizens of the world" had arrived. By the 1980s, satellite television had grown so popular, especially in rural and mountainous areas where standard TV reception was poor or cable TV business did not reach, that hundreds of thousands of people in the United States and around the world were installing their own personal satellite dishes in their backyards, thereby receiving into their homes directly from space a seemingly boundless number of channels and programs, only a small fraction of which they would have had access to through their local ultra-high frequency (UHF), VHF, or even cable stations. By the early 1990s, many people and governments around the world were relying for their news not on local or even national stations, but on Ted Turner's Cable News Network (CNN) via satellite from Atlanta.

In just a few decades, Arthur Clarke's idea for a global communications system (for which the British radio journal paid him the equivalent of a measly \$40) exploded into a multibillion-dollar industry, leading Clarke to pen a facetious little article, "A Short Pre-History of Comsats, Or: How I Lost a Billion Dollars in My Spare Time."⁸⁴ None of this, not even Clarke's humorous lament, would have been possible with just the passive reflectors.

Others besides Clarke also came to recognize the missed opportunities. In 1962 and 1963, when members of the Project Echo Task Group first learned in detail about the capabilities of the inaugural active comsats Telstar and Relay, they were a little disappointed that they had spent so much time on the passive reflector. "I remember thinking, damn, we worked on the wrong

Spaceflight Revolution

one!” recalls Norman Crabill. “Except I really didn’t because I had learned a lot. Whether it was active or passive, I had a job to do.”⁸⁵ In the late 1950s and early 1960s, before the advent of the silicon chip, which completely altered the scale of electronic devices and made possible the miniaturized amplifiers required for actively transmitting satellites, the passive reflector seemed to be the only “do-able” technology. Because of their work on passive satellite technology, Crabill and many other Langley researchers had prepared themselves well for the management of more significant unmanned spaceflight and satellite programs, such as Lunar Orbiter and the Viking landing on Mars.

7

Learning Through Failure: The Early Rush of the Scout Rocket Program

Failure analysis is basically research, when you get down to it. You recover and learn from mistakes; you don't do that with success.

—Eugene Schult, head of guidance
and control work for the Scout Project
at NASA Langley

Nothing demonstrates the pitfalls of rushing into space more dramatically than the early history of the Scout rocket program. This relatively small, four-stage solid-fuel rocket was conceived in 1956 by NACA engineers in Langley's PARD as a simple but effective way of boosting light payloads into orbit. Scout eventually proved to be one of the most economical, dependable, and versatile launch vehicles ever flown—not just by NASA but by anyone, anywhere. The program did not begin, however, with an impressive performance; it began with four years of confidence-crushing failures. To make Scout a success, researchers had to climb a long and torturous learning curve, which resembled, at least to those involved, the infernal hill up which Sisyphus eternally pushed his uncooperative rock.

“Itchy” for Orbit

Max Faget, Joseph G. Thibodaux, Jr., Robert O. Piland, and William E. Stoney, Jr., formed the core of a notoriously freethinking group within Langley's PARD. Early in 1956, a year and a half before *Sputnik 1*, this group began playing with the idea of developing a multistage hypersonic

Spaceflight Revolution

rocket.¹ These engineers had been launching dozens of rockets each year from the lonely beach at Wallops Island. To them, the idea of building one powerful enough to reach orbit did not seem at all farfetched.²

Moreover, the organizers of the IGY in 1955 had asked expressly for someone to put up the first artificial satellite as the highlight of the upcoming celebration. In response, the governments of the United States and the Soviet Union, respectively, on two consecutive days, 29 and 30 July 1955, had announced their rival intentions to launch satellites. Each country, given its burgeoning ballistic missile program, expressed confidence that it, and not the other, would be the first to put an object in space. A few months later, in the fall of 1955, the Eisenhower administration made the ultimately history-turning (and in the opinion of some critics, disastrous) decision to endorse the navy's Vanguard proposal—and Viking booster—as the way to launch America's first satellite. Viking's competitor, the army's Jupiter C rocket, the darling of von Braun and associates in Alabama, had to wait in the wings, ready to perform when the Vanguard program flopped.³

But von Braun's rocket experts were not the only ones "itchy" for orbit. The PARD group felt that the boosting of a small, lightweight payload into orbit would require only an extension of the hypersonic solid-fuel rocket technologies that they had been developing at Wallops Island and Langley since the early 1950s. "Solid-fueled rockets have always had the advantage over liquid-fueled as far as simplicity, cost, and possibly reliability," remembers PARD engineer and later Scout Project team member Roland D. "Bud" English. The PARD group's idea was to employ solid propulsion and use as many existing solid-fuel rockets for the various stages of the proposed launch vehicle as possible. "It was the logical extension of the work going on in PARD on solid rockets," says English. "It was a natural progression from Mach 15 [ballistic velocity] to the audacity to think in terms of orbit," agrees his colleague James R. Hall.⁴

In the mid-1950s, large solid-fuel rocket motors such as the Cherokee and the Jupiter Senior—the latter being the largest solid-fuel rocket motor up to that time—were undergoing rapid development to meet the need to power the U.S. military's growing fleet of ballistic missiles. The PARD engineers were convinced that by combining a few of these new motors intelligently into a three- or four-stage booster configuration, the NACA in a relatively short period could develop a launch vehicle that would have enough power to shoot past ballistic velocity and fly into orbit. This would require a speed of at least Mach 18. The Honest John rocket, a five-stage vehicle under development for the army, had achieved speeds of Mach 15 in flight tests at Wallops in the summer of 1956, and the Sergeant, a five-stage rocket also under development, was supposed to be capable of Mach 18. Other rocket-stage motors were under way for the navy's Polaris and Vanguard project missiles. From this promising menu, PARD engineers believed they could assemble a stack of rocketry that could achieve orbit.⁵

The Early Rush of the Scout Rocket Program

The only problems were that this stack would amount to “the most expensive vehicle ever developed by PARD” and “no funds were immediately available.”⁶ Furthermore, as the rocket was to serve as a satellite launch vehicle, it directly competed not only with the navy’s presidentially anointed Vanguard and the army’s overlooked Jupiter C, but also with the air force’s Thor-Able, which was rapidly nearing completion. These long-range military rockets, all of them liquid rather than solid-fuel, made the case for the little Scout harder to advocate. The modest PARD proposal for a simpler, cheaper, and potentially more reliable bantam rocket simply could not compete with such heavyweights.

Then came Sputnik, complicating this contest among American rocket initiatives. Engineer William Stoney, perhaps the earliest champion of what became the Scout Project, remembers feelings within PARD about Sputnik, “We were disappointed we weren’t the first but in another sense it reassured us that we were really on the right track—that, boy, we really could get supported from now on, because this was important that the U.S. continue to try to catch up, and we were part of that game.” Sputnik made the PARD rocketeers think “at a whole new level of exploration that heretofore was beyond consideration.”⁷

In the hectic and uncertain months following Sputnik, PARD tried to push a formal proposal for its rocket development through Langley management for consideration by NACA headquarters. In January 1958, however, Ira H. Abbott, one of the NACA’s assistant directors for research in Washington who had excellent connections to Langley, informed PARD that “NACA Headquarters would not be receptive to a proposal for development of another satellite vehicle.”⁸ However, the political environment for such proposals was in a state of flux in early 1958, and Langley engineers knew it; therefore, they kept design studies for their rocket going even after such an emphatic refusal.

In late March 1958, another Langley veteran, John W. “Gus” Crowley, associate director for research at NACA headquarters, revived hopes for the rocket when he asked Langley to prepare a “Space Technology Program” for the prospective new space agency. In its report, submitted on 15 May, the Langley senior staff, “without any opposition,” included the PARD concept “as a requirement of the program for the investigation of manned space flight and reentry problems.” The report stated that, for \$4 million, Langley could develop a booster that launched “small-scale recoverable orbiters” into space, and could do it in a matter of months.⁹

Even before the report circulated, on 6 May, Langley requested a research authorization to cover “the investigation of a four-stage solid-fuel satellite system capable of launching a 150-pound satellite in a 500-mile orbit.” Formal approval, which took just a few weeks, meant that PARD’s vehicle had officially made it into the space program.¹⁰ The air force’s interest in an advanced solid-fuel rocket test vehicle, with mutually acceptable specifications for a joint system negotiated in July, further secured Scout’s

Spaceflight Revolution

position. Such a deal eventually complicated the Scout Project greatly, however, because Langley had to take on the added burden of handling many of the contractual details for the coordinated NASA/DOD project. The DOD objective was to obtain a fleet of solid-fuel boosters for support of the air force's wide range of space research projects, which at that time included Dyna-Soar support, anti-ICBM research, and nuclear weapons. The last of these was to lead to the development of the so-called "Blue Scout" rocket.¹¹

After Scout won further approval, engineering analysis of the rocket system indicated that the proposed third-stage motor (an ABL X248) had to be replaced with a larger motor of the same type. This was a problem that could have killed an earlier proposal but now bothered no one. As one PARD veteran remembers, "The overall space plans for NASA were so grandiose when compared with NACA operations" that such changes, and such costs, were now relatively minor items.¹²

Little Big Man

Sometime during 1958, PARD's William Stoney, soon to be assigned overall responsibility for development of the new rocket, named it "Scout." Given engineers' propensity for acronyms, some believed Scout stood for "Solid Controlled Orbital Utility Test System"; however, Stoney insists today that the various acronyms that have appeared attached to the name "Scout" (even in official publications) have all been "after-the-fact additions." According to him, Scout was named in the spirit of the contemporary Explorer series of satellites with which the rocket would often be paired. He and his colleagues gave no thought at the time to deriving its name from a functional acronym.¹³

As for the technical definition of the rocket, as suggested earlier, the Langley engineers tried to keep developmental costs and time to a minimum by selecting components from off-the-shelf hardware. The majority of Scout's components were to come from an inventory of solid-fuel rockets produced for the military, although everyone involved understood that some improved motors would also have to be developed under contract.* By early 1959, after intensive technical analysis and reviews, Langley settled on a design and finalized the selection of the major contractors. The rocket's 40-inch-diameter first stage was to be a new "Algol" motor, a combination of the Jupiter Senior and the navy Polaris produced by the Aerojet General Corporation, Sacramento, California. The 31-inch-diameter second stage,

* The only new technology required for Scout was its hydrogen peroxide reaction-jet control system, developed by contractor Walter Kidde and Company, which enabled controlled flight outside the atmosphere. Later versions of this technology would be used for various purposes in space programs, including the spatial orientation and stabilization of "Early Bird," ComSatCorp's first experimental satellite.

The Early Rush of the Scout Rocket Program



In this photo from October 1960, Scout Test-2 (ST-2) stands ready for launch at Wallops Island.

L-60-6627

“Castor,” was derived from the army’s Sergeant and was to be manufactured by the Redstone Division of the Thiokol Company in Huntsville, Alabama. The motor for the 30-inch-diameter third stage, “Antares,” evolved under NASA contract from the ABL X248 design into a new version called the X254 (and subsequently into the X259); it was built under contract to NASA by ABL, a U.S. Navy Bureau of Ordnance facility operated by the Hercules Powder Company, Cumberland, Maryland. The final upper-stage propulsion unit, “Altair,” which was 25.7 inches in diameter (34 inches at the heat shield), amounted to an improved edition of the X248 that was also manufactured by ABL. Joining these four stages were transition sections containing ignition, guidance and attitude controls, spin-up motors, and separation systems.

Upon assembly of the vehicle, which was to be done by Chance Vought of Dallas, the rocket’s airframe and control-system contractor, the original Scout stood only 72 feet high from the base of its fins to the tip of its nose cone and weighed, at first-stage ignition, a mere 37,000 pounds. The thrust of the four stages added together totaled just over 200,000 pounds, which was easily enough to carry the proposed 150-pound payload into space, although at a 300-mile rather than a 500-mile orbit. (Later versions of Scout would

Spaceflight Revolution

eventually fly missions with 300-pound and even 450-pound payloads, using an optional fifth stage.)¹⁴

For such a comparatively small rocket, Scout turned into something quite significant—the first large NASA project that Langley ran in-house. The only previous in-house project to match Scout was the Bell X-1 supersonic research airplane of a decade earlier. The X-1, however, was a joint effort with the air force and was physically remote from Langley at faraway Muroc Dry Lake in California. The plane never got to Langley Field, although NACA Langley was primarily responsible for its development.¹⁵ The Scout project, on the other hand, was conceived, designed, and for the most part, built at Langley. Components were brought to nearby Wallops for launch and flight testing, thus making a “very tight Langley loop.”¹⁶

A formal “Scout Project Group” was not organized at Langley until February 1960 after a recommendation was made by a NASA headquarters review committee chaired by NASA Lewis Research Center’s Bruce Lundin.¹⁷ Until that time, all the work on the rocket had been overseen first by regular PARD management and later, after the creation of the STG in 1958, by Bob Gilruth and his staff. Gilruth already had his hands full with Project Mercury, but he reluctantly took over the responsibility for a short period because Abe Silverstein, whose Office of Space Flight Development initially funded Scout, insisted on it.* Given Gilruth’s intimate knowledge of PARD and its personnel, he trusted the Scout engineers to manage themselves. So did Langley Associate Director Floyd Thompson, who gave Scout personnel “remarkable freedom” to operate almost independently. “[Our work] was of course part of the race to catch the Russians,” James Hall has stated. “But more important it was to prove something to ourselves. People worked hard and were selfless about helping each other.” They were mostly young men “trying to do something that had never been done before.”¹⁸ Such naive enthusiasts neither cared for nor would have benefited from top-heavy management.

The project office started small with nine personnel: Project Office Head Bill Stoney, Technical Assistant Bud English, Administrative Assistant Abraham Leiss, three project engineers (C. T. Brown, Jr., Eugene D. Schult, and William M. Moore), Field Director James Hall, Project Coordinator Elmer J. Wolfe, Secretary Edith R. Horrocks, plus two resident representatives from industry. Each division of the laboratory also made one employee responsible for coordinating support for Scout whenever it was required.¹⁹

This skeletal crew and associated shadow organization began to race against the calendar to build and launch Scout. The project team grew in size rather quickly, so by 1962 more than 200 Langley staff members

* With the establishment of the Scout Project Group in February 1960, the Scout team began to report instead to Donald R. Ostrander, director of the new Office of Launch Vehicle Programs at NASA headquarters, which was established on 29 December 1959 and had responsibility for all launch vehicles.

The Early Rush of the Scout Rocket Program

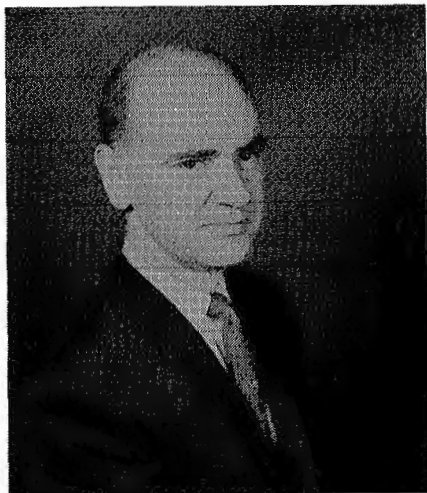

James Hall, Langley's original field director for the Scout Project Group.

L-61-5176

were working almost exclusively on Scout, which even project leaders had to concede was “a very large segment of people to work on anything at Langley.”²⁰ At Wallops, Scout work dominated, taking over several assembly shops and other buildings. The core staff in the project office stayed relatively small, however, reaching its peak of 55 employees in 1965 and then dropping back to 34 by the time of Scout flight number 75 in 1971.

The involvement of contractors was essential. Especially helpful were the people from Chance Vought—soon to be organized into the LTV Missile Group of the Chance Vought Corporation—who had won the bid to develop the Scout airframe and launching capability.²¹ The partnership between Langley and LTV grew into one of the most cooperative, fruitful, and long-lasting (30 years) in NASA history. As James Hall remembers so fondly, from almost the beginning, the Scout Project Office made “no distinction between government people and contractors. We were all on the same team and did what we had to do regardless of the color of our badges.” The feeling was mutual. According to Ken Jacobs, who worked many years on Scout for LTV, “We were very much more liable to work together than we were to work apart. If your counterpart in the government had a problem or a question, he would contact you on the telephone and [we would] be able to come up with a mutual agreement or solution. The end result was that the program would be much better off for experiencing this degree of cooperation between the two individuals who had the task.” Milt Green, another LTV employee, remarks, “We all had one common goal.” The teamwork resulted from “a mutual respect for each other. It wasn't an adversarial relation with a lot of gnarling of hands. [It was] strictly a job that had to be done, and done in the most reliable manner.”²²

Spaceflight Revolution



L-67-95

In this picture from June 1967, 32 LTV employees pose in front of the Scout S-159C, which a few months later on 19 October 1967 would successfully carry the RAM C-1 experiment into orbit.

This deeply felt sense of mutual reliance and cooperation, at least on Langley's part, related to the deeply ingrained, 40-year-old NACA culture. If Langley's work included Scout, and Scout needed LTV to succeed, then Langley needed LTV and would consider it a member of the family; that was the formula. The LTV staff appreciated it. "It was just a close-knit, dedicated group," remembers Larry Tant, a Scout operations manager for Langley. "We had a lot of pride in what we were doing. We were like brothers." "There was something about the program," declares Jon Van Cleve, an early Scout team member from Langley. "You worked in it for a little while and really got involved in it. When that happened, you lost the lines of whether you were agency, LTV, or air force. You became a Scout person."²³

These warm testimonials, which came years after Scout had amassed its remarkable record, were mostly made in the early 1990s when NASA honored members of the Scout team in official ceremonies. Both government and industry Scout staff reminisced about Scout's record, which no other booster, large or small, foreign or American, had surpassed. Langley's Scout Project Group enjoyed incredible strings of 22 and 37 consecutive launches without failure during two long periods, the first lasting from July 1964 until January 1967 and the second from September 1967 until December 1975. In 1991, when NASA Langley reluctantly turned over the direction of the Scout Project to NASA Goddard and the commercial production of the vehicle to LTV, the scorecard of 113 launches showed an overall success rate of an astounding 96 percent.

The Early Rush of the Scout Rocket Program

The retrospective comments about the great teamwork on the Scout Project need to be understood within the context of that final glorious record. The feelings between government and contractor could not have been so positive in the early years of the Scout program, when one rocket after another self-destructed or otherwise failed. In the Scout program, such can-do, throw-your-arm-around-your-buddy camaraderie developed only gradually and was tested severely by frequent early experiences with misfortune. These are trials that Scout team members understandably prefer to forget.

Little Foul-Ups

On 18 April 1960, only 14 months after the creation of the Langley Scout Project Office, the first experimental Scout sat ready to be fired from a new launch tower at Wallops Island. For weeks NASA headquarters had been demanding that “some type of flight test be made in the Scout program as soon as possible.”²⁴ The only way for Langley and its contractors to meet this demand was to work hours of overtime. James Hall recollects the days before this and other early Scout launches: “It was schedule-driven. People worked very hard and long hours. This was such a dynamic program, people felt compelled to work however long it took. The closer to launch, the more demanding the schedule became. At the launch site, people would often go without sleep to make up time or make something work or correct a problem. People were consumed by the program’s schedule.”²⁵

On 7 March, after deflecting the demands of NASA headquarters for as long as he could, Langley Director Floyd Thompson gave in and conceded that an unguided Scout, one greatly reduced in scope from later Scouts, could be fired under the direction of Langley’s Applied Materials and Physics Division (the old PARD) to obtain “some information on the overall configuration,” but preparations would take a month. The second stage of the rocket would have to be a weighted dummy, one of several supplied by the contractors for fitting transition sections during construction and for checking “overall alignment and general suitability including freedom from interference with components supplied by other contractors.” Thompson, reflecting the concerns of his Scout Project team, wanted it to be known that this was “not an official Scout test.” It was an “expedited launch,” a “Cub Scout,” meant only to obtain engineering data on the vehicle.²⁶

Several problems occurred during this hurried, “unofficial” test flight of Cub Scout. The rocket rolled more than anticipated during ascent, thus causing a structural failure near the burnout of the first stage. This failure prevented the third stage (atop the second-stage dummy motor) from test-firing. In addition, the heat-shield design proved defective by breaking away from the fourth stage as the vehicle passed through the transonic region. This was not the start everyone had hoped for. Scout Project personnel

Spaceflight Revolution



L-63-5567

Spectators—mainly the families of NASA employees—usually filled the makeshift grandstand at Wallops Island to witness the launch of NASA’s small unmanned rockets.

tried to put on a happy face, remarking that the test provided valuable experience assembling the rocket’s components on the new launcher and actually firing from it. No one, however, was fooled. The launch had been important to the test program and was meant to develop confidence in the systems. As one Langley engineer at the launch later recorded, “The failure was a blow to the prestige of the project, and efforts to complete the first actual Scout were redoubled.”²⁷

With these efforts, the first launch of a full-fledged Scout— ST-1—was to take place on 1 July 1960, less than three months after Cub Scout’s little foul-up. The anticipation level was extremely high. By the time of Scout Test-1, Langley had been firing rockets at Wallops for 16 years, since 1944. To Langley engineers launching rockets might have been “old hat,” but this launch was different. “Everybody was excited,” James Hall remembers with a gleam in his eye. “The concept of launching an orbital vehicle was a new and a really exciting challenge. That launch was the culmination of two years of intensive work. We had a number of practice countdowns and dry runs. We got our timing down and got things all set up. In fact, we were almost wearing that thing out testing it. That’s what you’re up

The Early Rush of the Scout Rocket Program

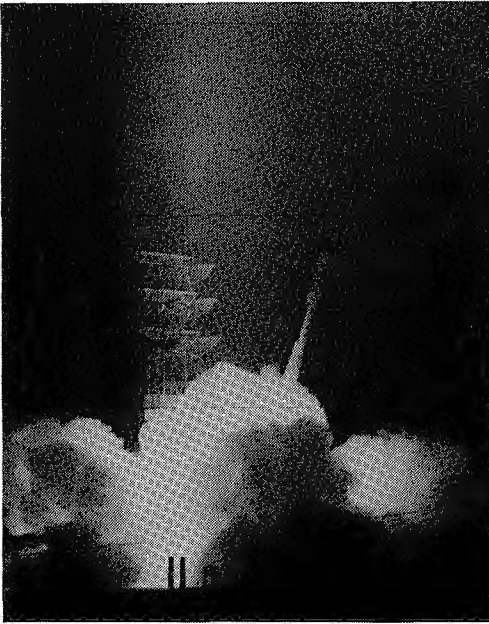

L-60-2565

The first Scout was launched on the evening of 1 July 1960.

against in space. But you reach a point where you have to come down to the countdown.”²⁸

The countdown lasted 11 hours. As it progressed, the Scout launch team gradually moved away from the vehicle. During the last hour or so, the rocketeers moved into a little cinder block building with three racks of switches, controls, and displays. By later launch system standards, it was simple, crude technology, but it was enough to light the fuse. Compared with ICBMs, Scout was tiny, but compared with all the previous rockets launched at Wallops, it was quite large. When the first-stage Algol motor was lit up, with its approximately 100,000 pounds of thrust, an awesome energy was released. As Hall describes it, “The ground shakes and the fire and smoke appear. It’s a very splendid thing.”²⁹ It was similar to being close to the heart of an earthquake, with massive pressure waves bouncing off the chest.

The rocket was to ascend into space and then use its last-stage Altair motor to fire a 193-pound acceleration and radiation package back through the atmosphere as a probe. But Scout did not reach a high enough altitude to fire the package. One of the new built-in features of the full-fledged Scout system was a destruct capability to be used if the rocket flew off course and endangered populated areas. Scout Test-1 would appear to do just that.

At 136 seconds after launch, radar tracking on the ground showed that the rocket had gone off course. A rolling moment (i.e., an aerodynamic

Spaceflight Revolution



L-62-6440

The cone-shaped cinder block building was the site of Scout's launch control.

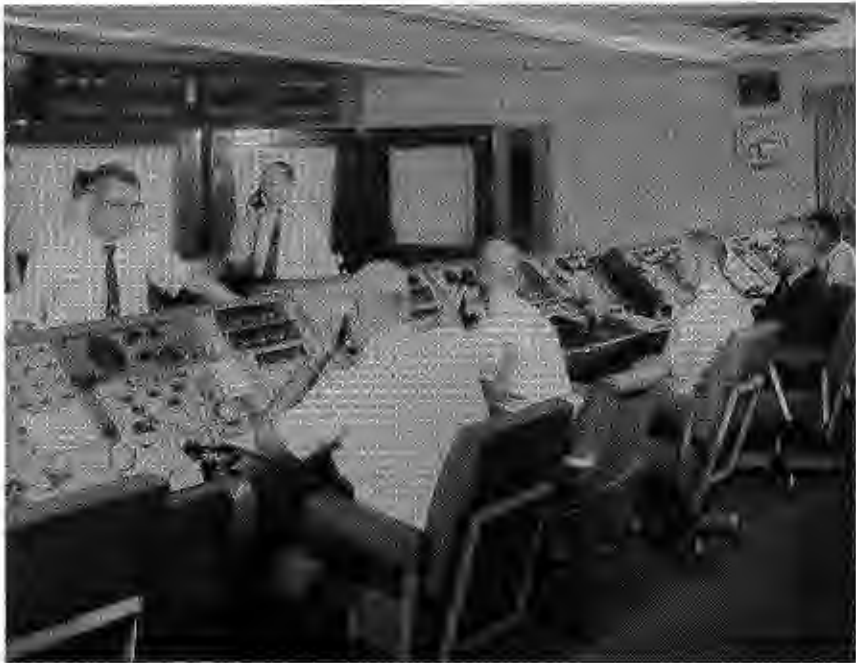

L-67-212

Worried looks on the faces of the NASA men in the control room at Wallops bear witness to the vicissitudes of launching rockets into space.

The Early Rush of the Scout Rocket Program

tendency to rotate the body about its longitudinal axis) developed with the Antares motor, and then it just as quickly dissipated. However, the rolling caused a very slight disorientation of the radar tracking. As the postflight test analysis would later show, the shift of the radar that was indicated on the plotboard meant that “the vehicle had taken a violent turn in azimuth and a dip down in elevation.” The rocket seemed to be about 50 degrees off course and heading somewhere it definitely was not supposed to go. This deviation forced the radar safety officer inside the blockhouse to take action. He actuated the “hold-fire” signal for the fourth stage, then, as James Hall, who was also in the blockhouse bitterly recalls, the range officer “waited as long as he could, looked over to us, and we had to concur. He hit the destruct button.”³⁰ The radar tracking recovered quickly, thus showing that there really never had been a significant problem.

“That was a crushing blow to destroy a rocket that was doing exactly what it was programmed to do,” Hall laments 30 years later, “but which just indicated on a range safety plotboard that it was on an incorrect trajectory. You can’t imagine how hard people worked as a group to bring this to the launch point.” Inside the blockhouse the men kicked cans and cursed the unfortunate safety officer. “But after an hour,” according to Hall, “most people recognized there was only one thing to do. That was to work and build the next vehicle, which we did in three or four months.” The spaceflight revolution demanded nothing less.³¹

In fact, circumstances also demanded that the test be labeled a success even when everyone knew better. The many subsequent chronicles of the Scout program all classified ST-1 as a success. “The fourth stage never had a chance to perform,” but “radiation measurements were successfully made to an altitude of 875 miles.”³²

“3-2-1 Splash”

On 4 October 1960, ST-2 proved to be the first real success of the project. Also launched as a probe with a radiation payload on board, the rocket reached a maximum altitude of 3500 miles and achieved a total range of 5800 miles. The newspaper headlines underscored the elation surrounding this successful launch. In the Newport News *Times Herald*, a large typeface banner headline celebrated the feat. The headline on page 12 of section A of the *Washington Post* read: “‘Poor Man’s Rocket’ Fired Successfully.” The *Washington Star* followed with a feature article, “Versatile Scout to Get Space Chores.” During this period, Scout also received additional positive publicity for the air force’s successful launch of two of its “Blue Scouts.”³³ The Scout Project was, indeed, looking up.

With this one successful but nonorbital mission behind them, the Scout leaders believed that testing was complete and that the missile was ready to start operations as one of NASA’s launch vehicles. As such, it would be used

Spaceflight Revolution

for three types of missions: placing small satellites in orbit, making high-velocity reentry studies and testing heat-resistant materials, and launching high-altitude and space probes. The Scout rockets were scheduled to take off not only from Wallops but also, beginning in early 1962, from a Scout launch site being prepared at the Western Test Range located on Vandenberg AFB in California. NASA headquarters was so optimistic about Scout that it arranged for a full-scale 72-foot model of the rocket to be displayed at the 15th annual meeting and "astronautical exposition" of the American Rocket Society in mid-December 1960. More than 5500 attendees viewed the model outside the Shoreham Hotel in Washington, D.C., and were impressed that it stood almost as high as the nine-story building.

Such a celebration of Scout proved premature. The first orbital flight from Wallops on 4 December 1960 failed. Now the headlines read, "NASA Fizzles Orbit Attempt" (*Virginian-Pilot*, 5 Dec. 1960), "Scout Sinks After Fizzle" (Norfolk-Portsmouth *Ledger-Star*, 5 Dec. 1960), "Feeling of Unsuccess Persists at Rocket Site" (Norfolk *Ledger-Dispatch*, 5 Dec. 1960), and "Rocket, Satellite Lie Under Deep Waters" (Richmond *News Leader*, 5 Dec. 1960). Three of the first six flights were in fact failures. Not long thereafter, Lt. Col. George Rupp, formerly project officer on the Bullpup missile weapons system, came to NASA from the U.S. Marine Corps to replace a disheartened Bill Stoney as director of Langley's Scout Project Office.* This change solved nothing because Stoney's management had not been the problem. In the first four months following Stoney's replacement, three out of four launches failed. A NASA investigation found faults with the electrical systems, the heat shield, the ignition systems, and much more. As a later Scout program brochure recalls, "This was a time of exhilarating successes and heart breaking failures. The space age was in its infancy and the participants were learning about the operation of complex systems in the unforgiving environment of a high speed flight through the atmosphere to the border of space."³⁴ Personal accounts come closer to the truth. Roland "Bud" English, one of the original nine members of the Scout Project Group and the fourth head of the Scout Project Office, remembers: "The Scout program was done in a rush. Unquestionably, everything was behind schedule, and there was pressure on NASA to perform. The Space Act had been passed, and NASA was supposed to be going up to do a job, and Scout was part of that. So there was very definitely a pressure to do it in a hurry, too much of a hurry, and not enough emphasis on proper quality and really getting ready for an operational flight."³⁵

Even with the many failures, the launch dates just kept coming. "None of us liked to slip a commitment," James Hall admits, "and slippages were relatively modest considering the complexity of the program. As things got down to deadline, completion of ground system checkout, completion of

* Rupp stayed in this post until his retirement from the military in June 1963, whereupon he was succeeded by Eugene D. Schult and later by Roland English.

The Early Rush of the Scout Rocket Program



Succeeding Rupp in June 1963 was Langley engineer Eugene D. Schult, who had been with the Scout Project Office from the start.

L-63-4479

launch tower checkout, and then the actual practice countdown and final launch countdown—those critical milestones—didn't slip that much, but people had to work 24 hours a day to hold them.”³⁶

Not until 20 July 1963 and the launch of Scout flight number 22 did the problem come to a head. (Preceding this flight, ironically, three consecutive missions had been successful, and two of three had been orbital.) Two and one-half seconds after liftoff at Wallops, a flame appeared above the first-stage fins. Two seconds later, the Algol stage became engulfed by fire. “It was obvious something terrible had happened,” Bud English recalls, frowning. “You could tell from the communications coming from the range safety net[work]. There had been a burnthrough of the first stage nozzle a few seconds after takeoff. The vehicle went through some wild gyrations. It got about 300 feet high and broke into three parts: the first stage went in one direction; the second stage went in another; and the third and fourth stages fell more or less back on the launch pad and burned. It was a disaster.”³⁷

Langley's Scout engineer Tom Perry was part of the recovery team that slogged through the salt marshes a mile off the coastal island to pick up bits and pieces of the rocket to help NASA determine what went wrong. He found one large chunk of the fiery debris in an unexpected place. “Someone had parked a small car inside one of the assembly buildings and it just so happened that a flaming piece of the rocket had come right down through the roof and into the front seat, burning that car to a crisp.”³⁸

Spaceflight Revolution

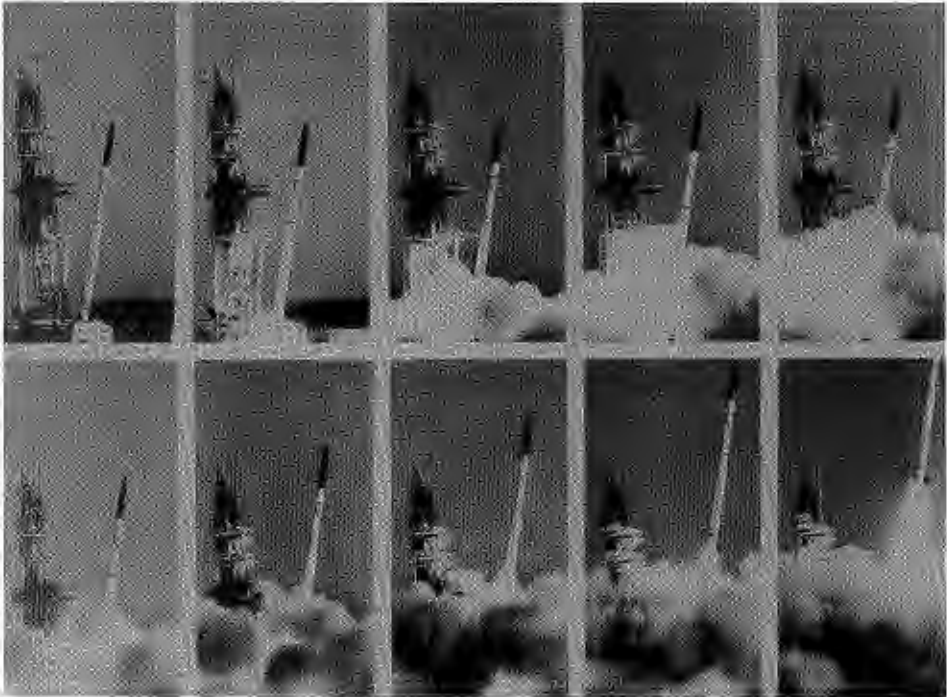

L-61-5743

As this sequence of photos demonstrates, the launch of ST-5 on 30 June 1961 went well; however, a failure of the rocket's third stage doomed the payload, a scientific satellite known as S-55 designed for micrometeorite studies in orbit.

NASA headquarters launched a formal investigation. A seven-man review board found flaws in a rocket nozzle that had gone undetected during production and testing. Following the board's recommendation, the space agency imposed a three-month moratorium on the launch schedule; no more Scouts would fly until a comprehensive study of all the data from the previous 21 Scouts had been completed.³⁹

Significantly, the in-depth investigations of the rocket's subsystems made during this review revealed that each Scout failure had been caused by a different problem. That in itself was the essential problem. "We never had the same failure twice," James Hall underscores, "but it was clear from the early record of Scout that there was enough miscellaneous failure that we had to sit down and rethink the whole thing very seriously."⁴⁰

Certain institutional and bureaucratic factors also had contributed to Scout's failures. As much as the Langley engineers had wanted to make Scout contractors and air force partners members of one integrated team, in many key essentials they simply were not. Former PARD engineer and

The Early Rush of the Scout Rocket Program



L-62-1729

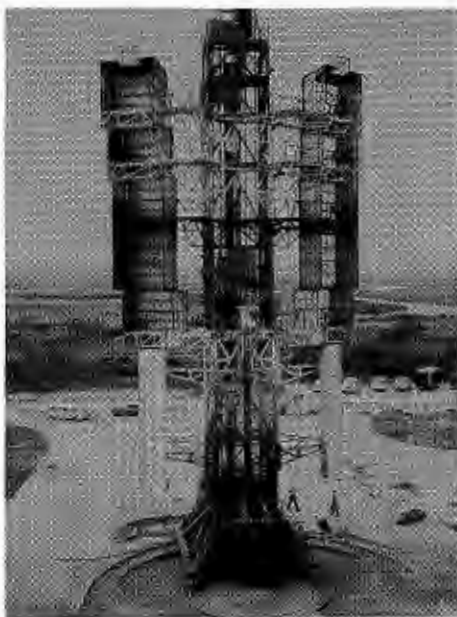

L-63-5790

What kept the Scout engineers going through the tough times was the occasional spectacular success. In this photo from 1 March 1962 (left), ST-8 streaks into the night sky above Wallops, carrying a reentry heating experiment. The burnthrough of ST-110's first-stage nozzle just seconds after firing on 20 July 1963 resulted in significant damage to the launch tower (right). Remnants of the third and fourth stages of the erratic Scout can be seen on the launchpad.

member of Langley's original Scout Project Office Eugene Schult remembers, "We did things differently at Wallops than at the Western Test Range. The air force had its own way of doing things; the contractor had his ways; and we had our ways. It was a problem trying to coordinate them."⁴¹ Essentially, each organization employed its own safety procedures: an assembly checkout line at the LTV plant in Dallas, other checkout lines on the ground at Wallops and Vandenberg, and yet two more lines in the towers at the launchers, both in California and Virginia. Each line used different equipment and procedures.

However, the principal cause of Scout's mishaps was simply the need to make everything happen so fast. The LTV mission integrator, Ken Jacobs, recalls how engineers scrambled to assemble the rocket: "Back in those days, if you needed a part, you did what we called a 'midnight requisition.' We'd go get the part from the space vehicle in inventory." This was obviously one of the shortcomings of the system. "People were robbing Peter to pay Paul, and the result was we had an unsuccessful vehicle." Over and above this "cannibalizing" of the hardware, Bud English feels that "there simply were



L-60-7980

In this photo from December 1960, employees of Vought Astronautics, Scout's prime contractor, work with NASA technicians to prepare ST-3 for launch. Unfortunately, this rocket would fail because of a second-stage misfire.

not good standardized vehicle safeguards and checkout procedures, which were needed to have a successful vehicle.”⁴²

“Our record was not good,” Jacobs has to admit. “Our reliability was 3-2-1 splash, 3-2-1 splash.” The time had come to “blow the whistle and take a look at this program and see what our problem was.” The Scout Project Office, LTV, the supporting engineers at Langley, the related air force personnel, and everyone involved had to sit down and do some “deep thinking” about what had to be done to fix not only the rocket but also the entire program.⁴³

Recertification

The Scout team decided that a 14-month reliability improvement program to recertify the rocket was needed. The effort was spearheaded by a NASA/LTV/air force “tiger team,” whose mission was “to revise completely how [the project office] handled the vehicle and to standardize the

The Early Rush of the Scout Rocket Program

process to the ultimate degree.”⁴⁴ The tiger team concept, which in essence was a technological commando squad, had already proved effective in industrial settings. NASA was beginning to use it more frequently in the 1960s to attack particularly troublesome problems. The tiger team’s activities started at Langley when James Hall, operations manager for Scout, wrote an inch-thick specification that laid out a single set of test equipment, a single checkout procedure, and the rigorous standards for using both.

Such an approach proved to be exactly what was needed. Under the direction of the tiger team, all 27 of the Scout rockets already manufactured for the program were returned to LTV in Dallas to be taken apart and inspected. Weld seams were X-rayed, and solder joints were inspected under microscopes. Everything that could be standardized was standardized. Even the lengths of the cable in Vought’s laboratories now had to match those at the two launch sites. The launch countdown now included more than 800 items. Additional tiger teams were put together at Wallops and at Vandenberg to assure compliance with the new standards. No Scout was to leave Dallas until an inspection team had done a complete worthiness review of the whole vehicle and given it a clean bill of health.⁴⁵

At the end of the long recertification process, nearly all members of the Scout team were confident that they now understood why things had gone wrong: from the time that NASA had adopted the concept for the little solid-fuel rocket and made it an agenda item for the spaceflight revolution, the Scout Project Group simply had had neither the time, nor the inclination, to look before they leaped. “We all underestimated the magnitude of the job at that time,” Milt Green admits. “The biggest problem we had was denying the existence of problems that we did not understand.”⁴⁶ The problem was, of course, all too human.

The process of honestly facing up to fundamental mistakes and moving beyond them was probably what made the Scout Project Group the remarkably successful organization it eventually became. Certainly the experience turned the project’s leaders into some of the most reflective of NASA’s engineer/philosophers. Eugene Schult, who was responsible for Scout’s guidance and control, ponders the project, “We wouldn’t learn anything if we didn’t have problems; that’s basic in engineering training. . . . Success doesn’t tell us anything. It doesn’t tell us where the limits are, or what the limiting aspects of the envelope are. But when you hit a mistake, you dig into it and you find out there’s a weakness. And by curing weaknesses you get success.”⁴⁷

Schult and his Scout group did indeed recover from failure. The first three launches after the recertification—in December 1963 (from Vandenberg), March 1964 (from Wallops), and June 1964 (from Vandenberg)—were all resounding orbital successes. Between July 1964 and January 1967, Scout established a record of 22 consecutive launches. Only one of the 16 recertified rockets experienced a failure. The pressure to succeed was now off. Scout workers no longer had to perform failure reviews every other month, and

Spaceflight Revolution

they no longer had to work the endless overtime and spend weekends away from their families. In such a positive environment, success bred success.

“Now we really had the kind of vehicle we’d set out to develop,” boasts Bud English. “Reliable. It was still simple and inexpensive, but we could launch [it] quickly.”⁴⁸ In fact, the Scout group needed only six weeks to process one of the rockets for a successful launch. Even with this short turnaround time, NASA would launch this little rocket for 10 years without a problem. English and his colleagues had indeed done the job they set out to do.

An Unsung Hero

Scout made a total of 113 flights under NASA Langley’s direction; the last one before the official transfer of the program to NASA Goddard and LTV took place on 9 May 1990 from Vandenberg AFB. As a result of these flights, NASA engineers and their contractors authored more than 1300 technical and scientific reports on various aspects of the rocket’s design, performance, and mission findings.⁴⁹

The pride that the Scout Project Group felt for the rocket’s performance sprang not only from its phenomenal post-recertification accomplishment rate of 22 and 37 successful launches but also from the critical roles played by Scout payloads in the advancement of atmospheric and space science. Early Scout missions helped researchers study the density of the atmosphere at various altitudes, the properties of the Van Allen radiation belts, and the possible dangers of the micrometeoroid environment on spacecraft. Scouts in the 1970s tested Einstein’s theory of relativity by carrying an extremely accurate atomic clock into space, and they also helped to confirm the theory of the “black hole.”

In support of NASA’s early space program, Scout was critical to the important research into reentry aerodynamics for the manned space missions. With the resulting data, NASA researchers determined what materials best withstood the heat of reentry. This information as well as other data acquired by Scout missions contributed directly to test programs such as Projects Fire and RAM and to the successes of Mercury, Gemini, and Apollo. In one notable mission in November 1970, the rocket carried two male bullfrogs into orbit. This turned out to be the only time a Scout satellite was to carry a living payload. The unusual mission enabled NASA to study the effects of space on the inner ear and thereby better understand the causes of the space sickness experienced by astronauts.

Scout also delivered into space several reconnaissance and communications satellites. For the DOD, the rocket launched classified payloads; for the navy, it put into orbit the satellites needed for its Transit system, which by the late 1960s provided instantaneous global navigation data not only for the operational fleet but also for commercial shipping worldwide.

The Early Rush of the Scout Rocket Program

Much of Scout's contribution was international: the rocket launched 23 satellites for foreign countries, including Germany, the Netherlands, France, and the United Kingdom, and the European Space Agency. Based on a 1961 agreement between the United States and Italy, NASA Langley supplied Scouts for an innovative Italian launch operation known as San Marco, which was established on two huge mobile platforms in the Indian Ocean, 3 miles off the coast of Kenya. From this unusual location in Ngwana Bay, the Centro Italiano Ricerche Aerospaziali (the Center for Italian Aerospace Research), starting in April 1967, used NASA Scouts to boost an international series of eight spacecraft into orbit. The flights of these spacecraft, many of which were placed into equatorial orbits, gathered valuable data about the ionosphere and the magnetosphere, about the galactic sources of radiation and X-rays, and especially about the nature of the earth's atmosphere in the region of the equator. Participation in the San Marco project incidentally gave some Langley engineers their first opportunity for foreign travel and international cooperation. In 1966 it even afforded some of them the rare opportunity of an audience with Pope Paul VI, who blessed the rocket. Fortunately, the launch of the anointed Scout went well.⁵⁰

Over the years, through the waning of the Apollo program and into the era dominated by the Space Shuttle, Scout became more of a bargain. Improvements in its stage motors enabled the rocket to carry larger payloads, but costs remained low.* Using the consumer price index, Langley employees hoping to retain the Scout program calculated that a Scout cost less when NASA Goddard took over the program (and LTV took over the rocket) in 1991 than the original \$4 million invested in it in 1958.⁵¹

In summary, Scout, although virtually unknown outside NASA circles, developed into one of the finest pieces of technology in the history of space exploration. As Tom Perry has observed about the evolution of his most cherished rocket, "The Scout became so reliable that mission planners could take it for granted. They focused on the science of the satellite payload rather than on its transportation system. . . . It happens to be NASA's smallest launch vehicle and it does not receive the same level of notoriety you would with a larger system. But over the years it has proven to be a very reliable, consistent, performing warhorse." As Perry and other Scout people at Langley, Houston, Wallops Island, Vandenberg AFB, and San Marco are still fond of saying, more than 30 years after its first countdown, Scout is "the unsung hero of space."⁵²

* For the first 10 production Phase II Scouts (Phase I was the developmental phase), the vehicle hardware costs amounted to \$0.96 million per vehicle; for the next 14 production Scouts (Phase III), the cost per vehicle rose to \$1.42 million. Costs decreased for the 25 Phase IV rockets (provided by LTV) to \$1.19 million per vehicle. Costs for later Scouts rose only slightly, and stayed under \$1.5 million per vehicle.

Spaceflight Revolution

From Italy's innovative San Marco launch operation in the Indian Ocean, NASA Langley helped to launch an international series of eight spacecraft into orbit. A huge mobile launcher lifts Scout into firing position (right); the San Marco platform floats securely in international waters in Ngwana Bay (below).



L-74-7828



L-71-1197

Postscript

A cynic might suggest that it was entirely in keeping with Scout's difficult and publicly unappreciated sojourn into space that the project ended as it did. In the late 1970s, NASA policymakers proposed to launch all future NASA satellites using the Space Transportation System (STS) still under development and abolish all expendable launch vehicles; the Space Shuttle, when fully operational, could do it all. Only the *Challenger* explosion in 1986, which underscored the need for alternative launch capabilities, reversed the shortsighted policy. In the aftermath of the *Challenger* accident, and in league with the Reagan administration's objectives for the commercialization of space and the privatization of many government services, NASA created the "Mixed Fleet" concept. Under this plan, NASA was to give up its other launch services to commercial firms, which from then on were to handle whatever NASA payloads the Shuttle could not carry. Essentially, this meant the end of the expendable launch vehicle business as NASA's Scout Project Group had known and developed it.⁵³

Scout engineers sorely lamented the loss of Scout. For them, the venture into space had come to mean an all-enveloping system and a rigorous discipline: a government-driven version for rockets of Henry Ford's mass production. "Other programs are full of changes and improvisations," declares James Hall; they are always "borrowing from other missiles and assembling something just to get it delivered on schedule"—which is exactly what the Scout team itself had been doing in the pre-recertification days.⁵⁴ Over time, however, the "cannibalizing" became minimal in Scout. The program for rocket assembly matured beyond the practice, thus becoming standard almost to the point of stereotype. Scout engineers wanted to produce a launch vehicle that was as reliable for a trip to space as an automobile was for a trip to town. Scout, like the Ford Model T, was the "poor man's rocket."

Learning hard lessons through failure and then enjoying such incredible long-term success made losing the rocket especially difficult for the Scout Project Group. Scout had been giving the country access to space for more than 30 years. It succeeded in spite of—and ironically perhaps because of—its hurried early development. Not many programs born of the spaceflight revolution survived the spaceflight revolution; Scout was one.

8

Enchanted Rendezvous: The Lunar-Orbit Rendezvous Concept

There was a reluctance to believe that the rendezvous maneuver was an easy thing. In fact, to a layman, if you were to explain what you had to do to perform a rendezvous in space, he would say that sounds so difficult we'll never be able to do it this century.

—Clinton E. Brown, head, Langley
Lunar Mission Steering Group
on Trajectories and Guidance

I'm not so sure we ever thought of rendezvous as very complicated. It's an amazing thing. We thought that if our guys could work out the orbital mechanics and we gave the pilot the right controls and stuff, then he'd land it and make the rendezvous. We didn't think it was very complicated.

—Arthur W. Vogeley, head, Langley
Guidance and Control Branch

On Thursday morning, 25 May 1961, in a speech to a joint session of Congress, President John F. Kennedy challenged the American people to rebound from their recent second-place finishes in the space race: "First, I believe that this nation should commit itself to achieving the goal, before this decade is out, of landing a man on the moon and returning him safely to earth. No single space project ... will be more exciting, or more impressive ... or more important ... and none will be so difficult or expensive." "It will not be one man going to the Moon," the dynamic 43-year-old president told his countrymen, "it will be an entire nation. For all of us must work to put him there."¹

Spaceflight Revolution

At first no one at Langley could quite believe it. If President Kennedy had in fact just dedicated the country to a manned lunar landing, he could not be serious about doing it in less than nine years. NASA had been studying the feasibility of various lunar missions for some time, but had never dreamed of a manned mission that included landing on and returning from the surface of the moon by the end of the 1960s. NASA was not exactly sure how such a lunar mission could be achieved, let alone in so little time.

Not even Bob Gilruth, the leader of the STG, was prepared for the sensational announcement. He heard the news in a NASA airplane somewhere over the Midwest on his way to a meeting in Tulsa. He knew that Kennedy planned to say something dramatic about the space program in his speech, and so he asked the pilot to patch it through on the radio. Looking out the window over the passing clouds, he had heard every incredible word. Only one word described Gilruth's feelings at that moment: "aghast." The first manned Mercury flight by Alan Shepard had taken place only three weeks before, on 5 May. NASA had made this one brief 15-minute suborbital flight, and suddenly the President was promising Americans the moon. The audacity of the goal was stunning.² American astronauts would fly a quarter of a million miles, make a pinpoint landing on a familiar but yet so strange heavenly body, blast off, and return home safely after a voyage of several days through space, and do it all by the end of the decade. Only one thought was more daunting to Gilruth, and that was that he was one of the main people who would have to make it happen. Already the STG had its hands full preparing for another suborbital flight (Virgil I. "Gus" Grissom's, on 21 July) and for the first orbital flight sometime early in the next year (John Glenn's, on 20 February 1962). Gilruth himself, before the president's announcement, "had spent almost no time at all" on lunar studies, so demanding were the activities of Project Mercury.³

Only the project managers directly responsible for making Mercury a success felt burdened by the prospects of now having to fulfill the lunar commitment. Other planners and dreamers about space exploration within NASA were elated.

When they heard about Kennedy's announcement, Clinton E. Brown and his adventurous colleagues cheered, "Hooray, let's put on full speed ahead, and do what we can." To them, landing astronauts on the moon as quickly as possible was obviously the next step if the United States was going to win the space race. Furthermore, Brown and his little band of men—plus one other key Langley researcher, Dr. John C. Houbolt—were confident that they already knew the best way to accomplish the lunar goal.⁴

Brown's Lunar Exploration Working Group

After Sputnik, a small circle of Langley researchers had plunged into the dark depths of space science. "We were aeronautical engineers," remembers

Enchanted Rendezvous: The Lunar-Orbit Rendezvous Concept

William H. Michael, Jr., a member of Brown's division who had recently returned to Langley after a two-year stint in the aircraft industry. "We knew how to navigate in the air, but we didn't know a thing about orbital mechanics, celestial trajectories, or interplanetary travel, so we had to teach ourselves the subjects." In the Langley Technical Library, Michael could find only one pertinent book, *An Introduction to Celestial Mechanics*, written in 1914 by British professor of astrophysics Forrest R. Moulton (someone Michael had never heard of).⁵ With this out-of-date text, Michael and a few associates taught themselves enough about the equations of celestial mechanics to grow confident in their computations. Before long, the novices had transformed themselves into experts and were using their slide rules and early electronic computers to calculate possible paths to the moon.

In anticipating the trajectories for lunar missions in the late 1950s, Brown, Michael, and the few others were leapfrogging over what most people considered to be "the logical next step" into space: an earth-orbiting space station. Little did they know that their mental gymnastics would set the direction of the U.S. space program for the next 30 years.

Following the wisdom of Konstantin Tsiolkovskii, Hermann Oberth, Guido von Pirquet, Wernher von Braun, and other spacefaring visionaries, most proponents of space travel believed that the first step humans would take into the universe would be a relatively timid one to some sort of space station in earth orbit. The station could serve as a research laboratory for unique experiments and valuable industrial enterprises, and from this outpost, human travelers could eventually venture into space using craft for trips to the moon, the planets, and beyond. Most NASA researchers believed that the space station was the perfect target project because it could focus NASA's space-related studies as well as its plans for future space exploration.⁶

Clint Brown and associates felt differently: they thought that the space station step must be skipped. The politics of the space race, not the inspired prophecies of the earliest space pioneers, were dictating the terms of our space program. The Russians had already demonstrated that they had larger boosters than the United States. This meant that they had the capability of establishing a space station first. As Brown explains, "If we put all our efforts into putting a space station around the world, we'd probably find ourselves coming in second again." The "obvious answer" was that "you had to take a larger bite and decide what can really give us leadership in the space race." To him "that clearly seemed the possibility of going to the moon and landing there."⁷

Inside Brown's Theoretical Mechanics Division, the conviction that lunar studies should take precedence over space station studies grew. In early 1959, Langley's assistant director, Eugene Draley, agreed to form a Langley working group to study the problems of lunar exploration. Brown, the catalytic group leader, asked for the participation of six of Langley's most thoughtful analysts: David Adamson, Supersonic Aerodynamics Division;

Spaceflight Revolution

Paul R. Hill, PARD; John C. Houbolt, Dynamic Loads Division; Albert A. Schy, Stability Research Division; Samuel Katzoff, Full-Scale Research Division; and Bill Michael of his own Theoretical Mechanics Division. Leonard Roberts, a talented young mathematician from England, eventually joined the group. Brown assembled these researchers for the first time in late March 1959 and periodically into 1960. Besides advising Langley management on the establishment of lunar-related research programs, Brown's group also organized a course in space mechanics for interested employees. For many, this course provided their first real brush with relativity theory. The Brown study group even worked to disseminate information about the moon by holding public seminars led by experts from Langley and from the nearby universities.⁸

Everything about this original lunar study group was done quietly and without much fuss. In those early days of NASA, the management of research was still flexible and did not always require formal research authorizations or approval from NASA headquarters in Washington. When Brown expressed his desire to work more on lunar exploration than on the space station, Draley simply told him, "Fine, go ahead." Henceforth, he and his lunar working group proceeded with their efforts to solve the problems of sending an American to the moon. Brown's group was doing what Langley researchers did best: exploring an interesting new idea and seeing how far they could go with it.

Langley researchers were not the only people in the United States thinking seriously about lunar missions. Officers in the air force, scientists in think tanks, professors at universities, and other engineers and researchers in and around NASA were all contemplating a journey to the moon. In February 1959, a month before the creation of Brown's Lunar Exploration Working Group at Langley, NASA headquarters had created a small "Working Group on Lunar and Planetary Surfaces Exploration" (evolving later into the "Science Committee on Lunar Exploration") chaired by Dr. Robert Jastrow, the head of NASA headquarters' new Theoretical Division. This group included such leaders in planetology and lunar science as Harold C. Urey, professor at large at the University of California at San Diego, several leading scientists from JPL in Pasadena, and a few from Langley. In their meetings Jastrow's group looked into the feasibility of both "rough" (later usually called "hard") and "soft" landings on the moon. In a rough landing, a probe would crash onto the surface and be destroyed, but only after an on-board camera had sent back dozens of valuable pictures to earth. In a soft landing, a spacecraft would actually land intact on the moon. Langley's Bill Michael sat in on one of the first meetings of the Jastrow Committee. In reaction to what he heard, Michael and others at Langley began developing ideas for photographic reconnaissance of the moon's surface from lunar orbit as well as for lunar impact studies.⁹ Houbolt, of Langley's Dynamic Loads Division, also attended some of these meetings to share his budding knowledge of the requirements for spacecraft rendezvous.

Enchanted Rendezvous: The Lunar-Orbit Rendezvous Concept

Committees Reviewing Lunar Landing Modes

Date Formed	Location	Title	Chairman
Feb. 1959	NASA HQ	Working Group on Lunar and Planetary Surfaces Exploration	Jastrow
Mar. 1959	Langley	Lunar Exploration Working Group	Brown
Apr. 1959	NASA HQ	Research Steering Committee on Manned Space Flight	Goett
Summer 1959	Langley	Manned Space Lab Group Subcommittee: Rendezvous	Nichols Houbolt
May 1960	Langley	Intercenter Review of Rendezvous Studies	Maggin
May 1960	Langley	Lunar Mission Steering Group Subcommittee: Trajectories and Guidance Subcommittee: Rendezvous	Becker Brown Houbolt
Oct. 1960	NASA HQ	Manned Lunar Landing Task Group (Low Committee)	Low
May 1961	NASA HQ	Ad Hoc Task Group for a Lunar Landing Study (Fleming Committee)	Fleming
May 1961	NASA HQ	Lundin Committee	Lundin
June 1961	NASA HQ	Ad Hoc Task Group for Study of Manned Lunar Landing by Rendezvous Techniques (Heaton Committee)	Heaton
July 1961	NASA HQ	NASA/DOD Large Launch Vehicle Planning Group (Golovin Committee)	Golovin
Dec. 1961	NASA HQ	Manned Space Flight Management Council	Holmes

Spaceflight Revolution

Two months later, in April 1959, NASA headquarters formed a Research Steering Committee on Manned Space Flight. Chaired by Harry J. Goett of NASA Goddard, this committee was to review man-in-space problems, recommend the missions to follow Project Mercury, and outline the research programs to support those missions.¹⁰

In its final report, which came at the end of 1959, the Goett Committee called for a manned lunar landing as the appropriate *long-term* goal of NASA's space program. Between that goal and the present Project Mercury, however, a major interim program designed to develop advanced orbital capabilities and a manned space station was needed. Before that program, to be named Gemini, took shape, however, basic priorities would change.

Langley's representative on the Goett Committee, Laurence K. Loftin, Jr., the technical assistant to Associate Director Thompson, agreed that the space station should be NASA's immediate goal. But two other members disagreed: the STG's Max Faget and George Low, NASA's director of spacecraft and flight missions in Washington. During meetings from May to December, they voiced what turned out to be the minority opinion that the moon should be NASA's *next* objective. George Low was particularly vocal in making the point. Not only did he want to go to the moon, Low also wanted to land on it, with men, and the sooner the better.¹¹

Michael's Paper on a "Parking Orbit"

At Langley, members of Brown's lunar exploration group were studying ways of accomplishing Low's dream. One of these studies, by Bill Michael, examined the benefits of "parking" the earth-return propulsion portion of a spacecraft in orbit around the moon during a landing mission.

The spark for Michael's interest in what came to be called a "parking orbit," a spacecraft in a waiting orbit around the moon or some other celestial body, was calculations he had made to see whether any advantage could be gained in a lunar mission from additional "staging." First explained by Tsarist Russia's space visionary Tsiolkovskii in the late 1800s, staging was the proven technological concept by which a self-propelled, staged-rocket vehicle (Tsiolkovskii called it a rocket "train") could ascend to greater heights as its stages expended their fuel and separated.

In a lunar landing mission, Michael speculated, flying a big rocket ship directly from the earth to the moon would be impractical. (Jules Verne's popular book and other science-fiction fantasies had pictured this method for a lunar landing.) Too much unnecessary weight would have to be transported to the moon's surface. How much wiser it would be to make "an intermediate step" and place the vehicle in lunar orbit where much of the total weight remained behind including the structure of the interplanetary spacecraft, its heavy fuel load for leaving lunar orbit and returning home, and its massive heat shield necessary for a safe reentry into the earth's

Enchanted Rendezvous: The Lunar-Orbit Rendezvous Concept



L-89-8683

At a colloquium held at Langley on 20 July 1989 to celebrate the 20th anniversary of the first lunar landing, William H. Michael, Jr., (center) reviews the evolution of his parking orbit concept with Clinton E. Brown (right), head of the Lunar Exploration Working Group and Arthur Vogeley (left), mastermind of Langley's rendezvous and docking simulators of the 1960s.

atmosphere. "It's very expensive to accelerate any type of mass to high velocity," Michael thought. "Any time you do *not* have to do that, you save a lot of fuel and thus a lot of weight."¹²

Michael wrote his calculations in 1960 in a never-to-be-published paper, "Weight Advantages of Use of Parking Orbit for Lunar Soft Landing Mission." In the paper, Michael identified the most basic advantage of what came to be known as lunar-orbit rendezvous (LOR). His results implied that LOR could save NASA an impressive 50 percent or more of the total mission weight. Figuring the numbers did not require any difficult or sophisticated calculations.¹³ Nor did it require any knowledge of the writings of Russian rocket theoretician Yuri Kondratyuk and British scientist and Interplanetary Society member H. E. Ross, both of whom had expressed the fundamentals of the LOR concept years earlier (Kondratyuk in 1916, and Ross in 1948).¹⁴ Neither Michael nor anyone else at Langley at this point, so they have always maintained, had any knowledge of those precursors.

They also knew nothing about competition from contemporaries; however, they soon would. The same morning that Michael first showed his

Spaceflight Revolution

rough parking-orbit calculations to Clint Brown, a team led by Thomas E. Dolan from Vought Astronautics, a division of the Chance Vought Corporation in Dallas, gave a briefing at Langley. The briefing concerned Vought's ongoing company-funded, confidential study of problems related to Manned Lunar Landing and Return (MALLAR) and specifically its plans for a manned spaceflight simulator and its possible application for research under contract to NASA.¹⁵

During the briefing, Dolan's staff mentioned an idea for reaching the moon. Although the Vought representatives focused their analysis on the many benefits of what they called a "modular spacecraft"—one in which several parts, including a lunar landing module, were designed for certain tasks—Brown and Michael understood that Vought was advertising the essentials of the LOR concept. "They got up there and they had the whole thing laid out," Brown remembers. "They had scooped us" with their idea of "designing a spacecraft so that you can throw away parts of it as you go along." For the next several days, Michael walked around "with his face hanging down to the floor."¹⁶

Nevertheless, the chagrined Langley engineer decided to write a brief paper because he was confident that he had come up with his idea independently. Furthermore, the word around Langley later came to be that Dolan had developed the idea of using a detachable lunar landing module for the landing operation after an earlier visit to Langley when PARD engineers familiar with Michael's embryonic idea had suggested a parking orbit to him. This explanation may simply be "sour grapes." On the other hand, Dolan had been visiting Langley in late 1959 and early 1960, and Michael does remember having already mentioned his idea to a few people at the center, "so it shouldn't have been any surprise to anybody here at Langley that such a possibility existed."¹⁷ The truth about the origin of Dolan's idea will probably never be known.

Michael's paper, at least in retrospect, had some significant limitations. It was only two pages long and presented little analysis. Its charts were difficult to follow and interpret. He did not mention "earth-escape weights," though an informed reader could infer such numbers. Perhaps most importantly, the paper did not explicitly mention either the need for a separate lunar lander or the additional weight savings derived from using one and discarding it before the return trip home. A reader would already have to be familiar with the subject even to recognize, let alone fully fathom, what was being implied. Michael's paper was hardly a fully developed articulation of a lunar landing mission using LOR. Nonetheless, it made a fundamentally important contribution: it made rendezvous the central theme for Langley researchers contemplating lunar missions. As his paper concluded, the chief problems in a lunar landing mission were the "complications involved in requiring a rendezvous with the components left in the parking orbit."¹⁸

Although disappointed by the news that Vought had scooped them with the idea of LOR, the Langley researchers were hardly demoralized.

Enchanted Rendezvous: The Lunar-Orbit Rendezvous Concept



L-62-8189

Three days before President Kennedy's lunar commitment, John D. Bird, "Jaybird" (left), captured Langley's enthusiasm for a moonshot in his sketch "TO THE MOON WITH C-1's OR BUST" (below). In essence, his plan called for a mission via earth-orbit rendezvous (EOR) requiring the launch of 10 C-1 rockets.

TO THE MOON WITH C-1's OR BUST

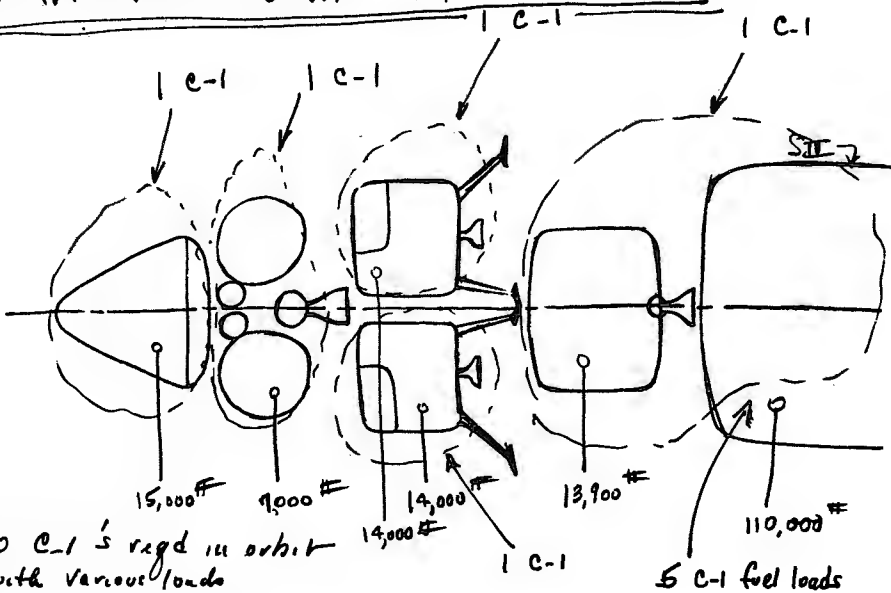

10 C-1's req'd in orbit with various loads

4 Modular connections
5 refueling operations

5/22/61

Spaceflight Revolution

Researchers in and around Brown's division quickly began making lunar and planetary mission feasibility studies of their own. John P. Gapcynski, for example, considered factors involved in the departure of a vehicle from a circular orbit around the earth. Wilbur L. Mayo calculated energy and mass requirements for missions to the moon and even to Mars. Robert H. Tolson studied the effects on lunar trajectories of such geometrical constraints as the eccentricity of the moon's orbit and the oblate shape of the earth, and also looked into the influence of the solar gravitational field. John D. Bird, "Jaybird," who worked across the hall from Michael, began designing "lunar bugs," "lunar schooners," and other types of small excursion modules that could go down to the surface of the moon from a "mother ship." Jaybird became a particularly outspoken advocate of LOR. When a skeptical visitor to Langley offered, with a chuckle, that LOR was "like putting a guy in an airplane without a parachute and having him make a midair transfer," Bird set the visitor straight. "No," he corrected, "it's like having a big ship moored in the harbor while a little rowboat leaves it, goes ashore, and comes back again."¹⁹

The Rendezvous Committees

A feeling was growing within NASA in late 1959 and early 1960 that rendezvous in space was going to be a vital maneuver no matter what NASA chose as the follow-on mission to Project Mercury. If the next step was a space station, a craft must meet and dock with that station and then leave it; if the next step was a lunar mission, that, too, would require some sort of rendezvous either in lunar orbit, as Michael's study suggested, or in earth orbit, where a lunar-bound spacecraft might be assembled or at least fueled. Even if neither of these projects was adopted, communications and military "spy" satellites would require inspection and repair, thus necessitating rendezvous maneuvers. Rendezvous would be a central element of all future flight endeavors—whatever NASA decided.

By late summer 1959, Langley's senior staff was ready to proceed with detailed studies of how best to perform rendezvous maneuvers in space. Two rendezvous study committees eventually were formed, both chaired by Dr. John C. Houbolt, the assistant chief of Langley's Dynamic Loads Division.

Houbolt was an aircraft structures expert who had begun work at Langley in 1942 with a B.S. and M.S. in civil engineering from the University of Illinois. In contrast to most Langley researchers, he had spent a significant amount of time conducting research abroad. He had been an exchange research scientist at the British Royal Aircraft Establishment at Farnborough, England, in 1949, and in 1958, Houbolt had only recently returned from a year at the Swiss Federal Polytechnic Institute in Zurich, where his dissertation on the heat-related aeroelastic problems of aircraft structures in high-speed flight had earned him a Ph.D.²⁰

Enchanted Rendezvous: The Lunar-Orbit Rendezvous Concept

Upon returning from his graduate work in Switzerland, Houbolt had found himself becoming more curious about spaceflight as were other Langley researchers. On his own, largely independent of the conversations taking place within Brown's group, Houbolt learned the fundamentals of space navigation. "I racked down and went through the whole analysis of orbital mechanics so I could understand it." From his own preliminary studies of trajectories, he saw the vital importance of rendezvous and began to recognize and evaluate the basic problems associated with it. During the STG's training of the Mercury astronauts at Langley, Houbolt taught them their course on space navigation.²¹

Houbolt focused on one special problem related to rendezvous—the timing of the launch. NASA could not launch a mission at just any time and be assured of effecting a rendezvous with an orbiting spacecraft. In order to visualize the problem, Houbolt built a gadget with a globe for the earth and a small ball on the end of a short piece of coat hanger for the satellite. He connected it all to a variable-ratio gearbox. The gadget simulated a satellite at different altitudes and in different orbital planes. With this little machine Houbolt could figure the time that satellites would take at varying altitudes to orbit the revolving earth. From his considerations of orbital mechanics, Houbolt found that a change in orbital plane at 25,000 feet per second without the help of aerodynamic lift would require such an enormous amount of energy that it could not be made. With this simple but ingenious model, Houbolt saw how long NASA might have to wait—a period of many days—in order to launch a rendezvous mission from Cape Canaveral. However, he also found a way to circumvent the problem: "if the orbital plane of the satellite could be made just one or two degrees larger than the latitude of the launch site," the launch "window" could be extended to four hours every day. Thus, he began to understand how NASA could avoid the long waiting periods.²²

The word quickly spread through Langley that Houbolt, the aircraft structures specialist, was now "the rendezvous man." He even had a "license to rendezvous" issued to him by the Rand Corporation, a nonprofit think tank (affiliated with Douglas Aircraft) in southern California. The Rand Corporation, which had an interest in space rendezvous and a space rendezvous simulator, presented Houbolt with this "license" in November 1959 after he successfully linked two craft on the Douglas rendezvous simulator.²³ Thus, when NASA Langley created its steering groups to study the problems of orbital space stations and lunar exploration missions, Houbolt naturally was asked to provide the input about rendezvous.

The first of Houbolt's rendezvous committees was linked to Langley's Manned Space Laboratory Group. Headed by the Full-Scale Research Division's Mark R. Nichols, an aerodynamics specialist who was reluctant to accept the assignment, this group was formed late in the summer of 1959. It was similar to Brown's interdivisional Lunar Exploration Working Group, except that it was larger and had committees of its own. One of

Spaceflight Revolution

them, Houbolt's committee, was to look into the matter of rendezvous as it pertained to earth-orbit operations. This it did in a "loosely organized and largely unscheduled" way during the first months of 1960. Serving on the committee were John M. Eggleston, Arthur W. Vogeley, Max C. Kurbjun, and W. Hewitt Phillips of the Aero-Space Mechanics Division; John A. Dodgen and William Mace of IRD; and John Bird and Clint Brown of the Theoretical Mechanics Division.²⁴ The overlapping memberships and responsibilities of the committees and study groups created during this busy and chaotic period have caused much confusion in the historical record about where the concept of LOR first arose at Langley and about who deserves the credit.

At one of the early meetings of the Manned Space Laboratory Group on 18 September 1959, Houbolt made a long statement on the rendezvous problem. In this statement, one of the first made on this subject anywhere inside NASA, Houbolt insisted that his committee be allowed to study rendezvous "in the broadest terms" possible because, as he argued correctly, the technique was certain to play a major role in almost any advanced space mission NASA might initiate.²⁵ Three months later, in December 1959, Houbolt appeared with other leading members of the Manned Space Laboratory Group before a meeting of the Goett Committee held at Langley. He urged the adoption of a rendezvous-satellite experiment—an experiment, in essence, similar to NASA's later Project Gemini—which could "define and solve the problems more clearly." The Goett Committee members, the majority of whom were still narrowly focusing on a space station and a circumlunar mission, showed little interest in Houbolt's experiment idea.²⁶

Representatives from Goddard, Marshall, and JPL met at Langley on 16–17 May 1960 for an intercenter review of NASA's current rendezvous studies. At this meeting, Houbolt gave the principal Langley presentation based on a paper he had just delivered at the National Aeronautical Meeting of the Society of Automotive Engineers in New York City, 5–8 April. All representatives were in "complete agreement" that rendezvous was "an important problem area" that opened "many operational possibilities" and that warranted "significant study." The strength of Houbolt's presentation demonstrated that of all the NASA centers, Langley was "expending the greatest effort on rendezvous." Eleven studies were under way at the center compared with three at Ames and two each at Lewis and the Flight Research Center. Marshall had an active interest in rendezvous but only in connection with advanced Saturn missions. With their "leanings toward orbital operations," von Braun's people had done little work specifically on rendezvous and were not prepared to talk about what little they had done.²⁷

One week after the intercenter review, a second rendezvous committee met for the first time. It was part of a Lunar Mission Steering Group created by Director Floyd Thompson. Chairing this group was hypersonics specialist John V. Becker, chief of the Aero-Physics Division.²⁸ Much larger and more formal than Brown's original little band of lunar enthusiasts, the

Enchanted Rendezvous: The Lunar-Orbit Rendezvous Concept

group chaired by Becker incorporated the Brown group, with the dynamic Brown himself serving as chairman of the new group's subcommittee on trajectories and guidance. Five other subcommittees were quickly organized: Howard B. Edwards of IRD chaired an instrumentation and communications committee; Richard R. Heldenfels of the Structures Research Division headed a committee on structures and materials; Paul R. Hill of the Aero-Space Mechanics Division was in charge of a committee on propulsion, flight testing, and dynamic loads; Eugene S. Love, Becker's assistant chief of the Aero-Physics Division, led a committee on reentry aerodynamics, heating, configuration, and aeromedical issues; and John C. Houbolt headed the rendezvous committee. Serving with Houbolt were Wilford E. Silvertson, Jr., of IRD and John Bird and John Eggleston, who were also members of his other rendezvous committee for the Manned Space Lab Group.

Becker's Lunar Mission Steering Group was to take a "very broad look at all possible ways of accomplishing the lunar mission." At the time NASA envisioned a circumlunar rather than a landing mission. (By late summer 1960, Lowell E. Hasel, secretary of Becker's study group, was referring to it in his minutes as the "LRC Circumlunar Mission Steering Group.") More specifically, the Becker group was to decide whether it approved of the general guidelines for lunar missions as established by the STG in meetings a month earlier, in April 1960.²⁹ In the next six months, Becker's group met six times, sent representatives to NASA headquarters and Marshall Space Flight Center for consultation and presentation of preliminary analyses, and generally educated itself in the relevant technical areas. Its exploratory experimental data eventually appeared in 12 Langley papers presented at the first NASA/Industry Apollo Technical Conference held in Washington from 18-20 July 1961. Long before that time, however, Langley's Lunar Mission Steering Group discontinued its activities. In mid-November 1960, when the STG developed its formal Apollo Technical Liaison Plan, which organized specialists in each problem area from every NASA center, the group was no longer needed and simply stopped meeting.³⁰

Houbolt Launches His First Crusade

In his paper presented before the Society of Automotive Engineers in April 1960, Houbolt had focused on "the problem of rendezvous in space, involving, for example, the ascent of a satellite or space ferry as to make a soft contact with another satellite or space station already in orbit." His analysis of soft rendezvous could have applied to a lunar mission, but Houbolt did not specifically refer to that possibility.³¹

He had been seriously studying it, as revealed in the minutes of a meeting of Langley's Manned Space Laboratory Group held on 5 February 1960. On that occasion Houbolt discussed the general requirements of a "soft landing device" in a lunar mission involving LOR. He did so in spite of the fact that

Houbolt's Early Crusades

Date	Location	Presentation Audience
Sept. 1959	Langley	Manned Space Lab Group
Dec. 1959	Langley	Goett Committee
Feb. 1960	Langley	Manned Space Lab Group
Apr. 1960	New York	Society of Automotive Engineers
Spring 1960	Langley	Robert Piland and STG members (informal)
Spring 1960	Langley	William Mrazek
May 1960	Langley	Intercenter Review
Sept. 1960	Langley	Seamans (informal)
Nov. 1960	Pentagon	Air Force Scientific Advisory Board
Dec. 1960	Langley	STG leaders
Dec. 1960	NASA HQ	Headquarters staff including Glennan, von Braun, Seamans, and Faget

this particular rendezvous committee was supposed to be focusing more narrowly on a rendezvous with an earth-orbiting space station.³²

From this point on, Houbolt began to advertise LOR in meetings and conversations. In the spring of 1960, he talked about LOR with Robert O. Piland and other members of the STG at Langley. During the same period, Houbolt mentioned LOR to William A. Mrazek, director of the Structures and Mechanics Division at Marshall. Houbolt had been helping Mrazek to evaluate the S-IV stage (consisting of four uprated Centaur engines) of the Saturn rocket.³³

In the summer of 1960, while making back-of-the-envelope calculations to confirm the savings in rocket-boosting power gained by the LOR approach, Houbolt experienced a powerful technological epiphany. Three years later, in a 1963 article, he described what happened: "Almost simultaneously, it became clear that lunar-orbit rendezvous offered a chain reaction simplification on all 'back effects': development, testing, manufacturing, erection, count-down, flight operations, etc." In this moment of revelation, Houbolt made an ardent resolve: "I vowed to dedicate myself to the task." From

Enchanted Rendezvous: The Lunar-Orbit Rendezvous Concept

that instant until NASA's selection of the mission mode for Project Apollo in July 1962, he tirelessly crusaded for the LOR concept.³⁴

On 1 September 1960, Dr. Robert C. Seamans, who had a Ph.D. in aeronautical engineering and was a former member of an NACA technical subcommittee, became NASA's new associate director. One of his first official duties was visiting all the agency's field centers for orientations about their programs and introductions to their personnel. During his visit to Langley, one of the many people he encountered was an excited John Houbolt, who seized the moment to say something privately about the advantages of LOR. He told the associate administrator, "We ought to be thinking about using LOR in our way of going to the moon."³⁵

Bob Seamans, in his previous job as chief engineer for RCA's Missile and Electronics Division in Massachusetts, had been involved in an air force study known as Project Saint—an acronym for *satellite interceptor*. This "quiet but far-reaching" classified military project involved the interception of satellites in earth orbit. Project Saint predisposed Seamans to entertain ideas about rendezvous techniques and maneuvers. Houbolt explained to him that LOR would work even if less weight than that of the entire spacecraft was left in a parking orbit. If only the weight of the spacecraft's heat shield was parked, NASA could realize some significant savings. Impressed with the importance of leaving weight in orbit, and equally impressed with Houbolt's zeal, Seamans invited the impassioned Langley researcher to present his ideas formally before his staff in Washington.³⁶

Before that presentation, however, Houbolt gave two other briefings on rendezvous: the first, in November 1960, to the Air Force Scientific Advisory Board at the Pentagon; the second, on 10 December, to leading members of the STG including Paul Purser, Robert Piland, Owen Maynard, Caldwell Johnson, James Chamberlin, and Max Faget. (Gilruth was not present.) In both talks, Houbolt spoke about *all* the possible uses of rendezvous. For LOR, the uses included a manned lunar landing, and for earth-orbit rendezvous (EOR) they included assembly of orbital units, personnel transfer to a space station, proper placement of special purpose satellites, and inspection and interception of satellites. Houbolt stressed that rendezvous would be both inherently useful and technically feasible in many space missions. Historians have missed this key point about Houbolt: he was advocating rendezvous generally, not just LOR.

If humans were going to land on the moon using existing rocket boosters, or even the boosters that were then on the drawing boards, a combination of EOR and LOR would be required. "We would put up a component with a first booster; we would put up another component with another booster; then we would rendezvous the two of them in earth orbit. Then we would go to the moon with this booster system and perform the lunar-orbit rendezvous with the remaining spacecraft. The whole reason for doing it this way would be because the boosters were still too small."

Spaceflight Revolution

Although he presented several rendezvous concepts, Houbolt championed LOR. With charts showing a soft manned lunar landing accomplished both with the Saturn-class rockets then in development and with existing launch vehicles such as Atlas or Langley's Scout, Houbolt concluded his lecture by emphasizing the "great advantage" of LOR. In a lunar landing mission, the earth-boost payload would be reduced two to two-and-a-half times. "I pointed out over and over again" that if these boosters could be made bigger, then NASA "could dispense with the earth-orbit rendezvous portion and do it solely by lunar-orbit rendezvous."³⁷

Houbolt recalls that neither the Scientific Advisory Board nor the STG seemed overly interested; however, they did not seem overly hostile. He was to experience this passive reaction often in the coming months. But not all the reactions were so passive. Some of them, from intelligent and influential people inside the space program, were loud, harshly worded, and negative.

On 14 December 1960, Houbolt traveled to Washington with a group of Langley colleagues to give the staff at NASA headquarters the briefing he had promised Bob Seamans three months earlier. All NASA's important people were in the audience, including Keith Glennan, Seamans, Wernher von Braun, and the leadership of the STG. For 15 minutes, Houbolt moved carefully through his charts and analysis. He concluded, as he had done in the earlier briefings, with an enthusiastic statement about LOR's weight savings—a reduction of earth payload by a "whopping" two to two-and-a-half times.

When he finished, a small man with a receding hairline and a bow tie jumped up from the audience. Houbolt knew all too well who he was: the hot-blooded Max Faget, his longtime Langley associate and present member of the STG. "His figures lie." Faget accused. "He doesn't know what he's talking about." Even in a bull session at Langley, Faget's fiery accusation would have been upsetting. But "in an open meeting, in front of Houbolt's peers and supervisors," it was "a brutal thing for one Langley engineer to say to another."³⁸ Faget had not bothered to voice these doubts four days earlier during the more private STG management briefing at Langley, when Houbolt and the others who were to give talks at headquarters had rehearsed their presentations. Faget continued his vocal objections in the hallway after the headquarters briefing was over. Houbolt tried to stay calm, but clearly he was agitated. He answered the charge simply by telling Faget that he "ought to look at the study before [making] a pronouncement like that."³⁹ It was an "ought to" that Houbolt would be passing on to many LOR skeptics before it was all over.

Curiously, earlier at the same NASA headquarters meeting, Clint Brown had made a presentation based on a study he had done with Ralph W. Stone, Jr., of the Theoretical Mechanics Division. Brown had explained a general operational concept for an LOR plan for a manned lunar mission. Brown's basic idea was to develop an early launch capability by combining several existing rocket boosters, specifically the Atlas, Centaur, and Scout.

Enchanted Rendezvous: The Lunar-Orbit Rendezvous Concept

He also illustrated the advantage of rendezvous for weight reduction over direct ascent. But oddly, Brown's talk—unlike Houbolt's—did not provoke a strong negative reaction.⁴⁰ Perhaps this was because Houbolt gave a more explicit analysis of the advantages of LOR over the direct approach, or perhaps it was because Brown had given his presentation first and Faget needed to build up some steam, or perhaps it was personal, with Faget simply liking Brown better than he liked Houbolt.

The Feelings Against LOR

The basic premise of the LOR concept that NASA would eventually develop into Project Apollo was to fire an assembly of three spacecraft into earth orbit on top of a single powerful (three-stage) rocket, the Saturn V. This 50,000-pound-plus assembly would include a mother ship or command module (CM); a service module (SM) containing the fuel cells, attitude control system, and main propulsion system; and a small lunar lander or excursion module. Once in earth orbit, the last stage of the Saturn rocket would fire and expend itself, thus boosting the Apollo spacecraft with its crew of three astronauts into its trajectory to the moon. Braking into lunar orbit via the small rockets aboard the service module, two members would don space suits and climb into the lunar excursion module (LEM), detach it from the mother ship, and pilot it to the lunar surface. The third crew member would remain in the CM, maintaining a lonely but busy vigil in lunar orbit. If all went well, the top half or ascent stage of the LEM would rocket back up, using the ascent engine provided, and redock with the CM. What remained of the lander would then be discarded to the vast void of space—or crashed on the moon as was done in later Apollo missions for seismic experiments—and the three astronauts in their command ship would head for home.*

Knowing what we know now, that is, that the United States would land Americans on the moon and return them safely before the end of the decade using LOR, the strength of feeling against the concept in the early 1960s is hard to imagine. In retrospect, we know that LOR enjoyed—as Brown, Michael, Dolan, and especially John Houbolt had said—several advantages over its competitors. It required less fuel, only half the payload, and somewhat less new technology; it did not require a monstrous rocket such as the proposed Nova for a direct flight; and it called for only one launch from earth, whereas one of LOR's chief competitors, EOR, required at least two. Only the small lightweight LEM, not the entire spacecraft, would have to land on the moon. This was perhaps LOR's major advantage. Because

* One can summarize the LOR concept with three specifications: (1) *Only* a specially designed LEM would actually descend to the moon's surface; (2) *Only* a portion of that LEM, the ascent stage, would return to dock with the CM in lunar orbit; and (3) *Only* the CM or Apollo capsule itself, with its protective heat shield, would fall back to earth.

Spaceflight Revolution

the lander was to be discarded after use and would not be needed to return to earth, NASA could customize the design of the LEM for maneuvering flight in the lunar environment and for a soft lunar landing. In fact, the beauty of LOR was that NASA could tailor all the modules of the Apollo spacecraft independently—without those tailorings having to compromise each other. One spacecraft unit to do three jobs would have forced some major concessions, but *three* units to do three jobs was another plus for LOR that no one at NASA, finally, could overlook.

In the early 1960s, these advantages were theoretical, but the fear that American astronauts might be left in an orbiting coffin some 240,000 miles from home was quite real. If rendezvous had to be part of the lunar mission, many people felt it should be attempted only in earth orbit. If rendezvous failed there, the threatened astronauts could be brought home simply by allowing the orbit of their spacecraft to deteriorate. If a rendezvous around the moon failed, the astronauts would be too far away to be saved. Nothing could be done. The specter of dead astronauts sailing around the moon haunted those responsible for the Apollo program. This anxiety made objective evaluation of LOR by NASA unusually difficult.

John Houbolt understood NASA's fears, but he recognized that all the alternative schemes had serious pitfalls and dreadful possibilities of their own. He was certain that all the other options would be more perilous and did not really offer rescue possibilities. The LOR concept, in contrast, did offer the chance of a rescue if *two* small landing modules, rather than one, were included. One lander could be held in reserve with the orbiting mother ship to go down to the lunar surface if the number one lander encountered serious trouble. Or, in the case of an accident inside the command-service module, one attached LEM could serve as a type of "lifeboat."* Houbolt just could not accept the charge that LOR was inherently more dangerous, but neither could he easily turn that charge aside.

The intellectual and emotional climate in which NASA would have to make perhaps the most fundamental decision in its history was amazingly tempestuous. The psychological obstacle to LOR's progress made the entire year of 1961 and the first seven months of 1962 the most hectic and challenging period of John Houbolt's life.⁴¹

On 5 January 1961, Houbolt spoke again on rendezvous during the first afternoon session of a historic two-day Space Exploration Program Council (SEPC) in Washington. This council had been created by NASA for "smoothing out technical and managerial problems at the highest level." Chaired by the associate administrator, this council meeting—the first that

* This scenario would indeed happen during the mission of Apollo 13, when outward bound and 200,000 miles from earth, an explosion in one of the oxygen tanks within the service module caused a leak in another oxygen tank and confronted NASA with an urgent life-threatening problem. NASA solved the problem by having the astronauts head home, without landing, and by moving them temporarily into the atmosphere of the LEM.

Enchanted Rendezvous: The Lunar-Orbit Rendezvous Concept

Seamans presided over—including, as always, all program office heads at headquarters, the directors of all NASA field centers, and their invited guests and speakers. The SEPC had been meeting quarterly since early 1960, but this first meeting of 1961 was by far the most historic to date; it was the first meeting inside NASA to feature an agencywide discussion of a manned lunar landing.⁴²

At the end of the first day of this meeting, everyone agreed that the mission mode for a manned lunar landing by NASA could be reduced to three options: direct ascent, which was still the front-runner; EOR, which was gaining ground quickly; and LOR, the dark horse on which only the most capricious gamblers in NASA would have ventured a bet.

One speaker had presented each option. First, Marshall's impressive rocket pioneer from Germany, Wernher von Braun, reviewed NASA's launch vehicle program, with an eye to the advantages of EOR. Von Braun explained how two pieces of hardware could be launched into space independently using advanced Saturn rockets then under development; how the two pieces could rendezvous and dock in earth orbit; how a lunar mission vehicle could be assembled, fueled, and detached from the joined modules; and how that augmented ship could proceed directly to the surface of the moon and after exploring, return to earth. The clearest immediate advantage of EOR, as von Braun pointed out, was that it required a pair of less powerful rockets that were already nearing the end of their development. Two of his early Saturns would do the job. The biggest pitfall of EOR, as with direct ascent, was that no one knew how the spacecraft would actually make its landing. On the details of that essential maneuver, von Braun said nothing other than to admit that more serious study would have to be done very quickly.⁴³

Next, Melvyn Savage of the Office of Launch Vehicle Programs at NASA headquarters explained direct ascent. A massive rocket roughly the size of a battleship would be fired directly to the moon, land, and blast off for home directly from the lunar surface. The trip required one brute of a booster vehicle, the proposed 12-million-pound thrust Nova rocket.

Late in the afternoon, Houbolt came to the podium to discuss rendezvous and highlight the unappreciated strengths of his dark-horse candidate. To him the advantages of LOR and the disadvantages of the other two options were obvious. Any single rocket such as Nova that had to carry and lift all the fuel necessary for leaving the earth's gravity, braking against the moon's gravity as well as leaving it, and braking against the earth's gravity was clearly not the most practical choice—especially if the mission was to be accomplished in the near future. The development of a rocket that mammoth would take too long, and the expense would be enormous. In Houbolt's opinion, EOR was a more reasonable choice than direct ascent but not as sensible as LOR. After the lunar-bound spacecraft left its rendezvous station around the earth, the rest of an EOR mission would be accomplished in exactly the same way as direct ascent. NASA's crew of astronauts would

Spaceflight Revolution

Houbolt's Later Crusades

Date	Location	Presentation Audience
Jan. 1961	NASA HQ	Space Exploration Program Council Meeting
Jan. 1961	Langley	STG members
Jan. 1961	Langley	Pearson (Low Committee)
Jan. 1961	NASA HQ	NASA Headquarters staff
Apr. 1961	Langley	STG
May 1961		Letter to Seamans (NASA HQ)
June 1961	NASA HQ	Lundin Committee
June 1961	France	International Space Flight Symposium
July 1961	Langley	Rehearsal with STG
July 1961	Washington, D.C.	NASA/Industry Apollo Technical Conference
Aug. 1961	NASA HQ	Golovin Committee
Aug. 1961	Langley	STG
Nov. 1961		Letter to Seamans (NASA HQ)
Jan. 1962	Langley	Shea and STG
Jan. 1962	MSC, Houston	Manned Spacecraft Center personnel
Feb. 1962	NASA HQ	Manned Space Flight Management Council
Apr. 1962		Report and papers sent to von Braun (MSFC)

have to land an incredibly heavy and large vehicle on the surface of the moon. The business of backing such a large stack of machinery down onto the moon and "eyeballing" a pinpoint soft landing on what at the time was still a virtually unknown lunar surface would be incredibly tricky and dangerous. Those few NASA researchers who had been thinking about the terrors of landing such a behemoth (and getting the astronauts down from

the top of it using some little inside elevator!) knew that no satisfactory answers to these problems were on the horizon.⁴⁴

Other talks were given that day, including an introduction by George Low, chair of NASA headquarters Manned Lunar Landing Task Group (formed in October 1960), and a technical talk by Houbolt's nemesis Max Faget outlining the hardware and booster requirements for several possible types of lunar missions. Everyone walked away from the meeting understanding that, if the United States was someday to reach the moon, NASA would have to choose a plan soon.⁴⁵ At this point, the odds were excellent that the choice would be direct ascent, which seemed simplest in concept. Coming in second, if a vote had been taken that day, would have been EOR. LOR, to many NASA officials present, was an option almost unworthy of mention.

The Early Skepticism of the STG

In the early months of 1961, the STG was preoccupied with the first manned Mercury flight and the hope—soon to be crushed by *Vostok 1*—that an American astronaut would be the first human in space. When any of its members had a rare moment to consider rendezvous, they were typically thinking about it “as one of several classes of missions around which a Mercury program follow-on might be built.”⁴⁶

At Langley on 10 January 1961, five days after the meeting of the SEPC, Houbolt went with three members of the Theoretical Mechanics Division—the division chief Clint Brown, Ralph Stone, and Manuel J. “Jack” Queijo—to an informal meeting at the center with three members of the STG's Flight Systems Division—H. Kurt Strass, Owen E. Maynard, and Robert L. O'Neal. Langley Associate Director Charles Donlan, Gilruth's former chief assistant, also attended. At this meeting Houbolt, Brown, and the others tried to persuade representatives from the STG that a rendezvous experiment belonged in the Apollo program and that LOR was the way to go if any plans for a manned lunar landing were to be made.⁴⁷

They were not persuaded. Although the STG engineers received the analysis more politely than had cohort Max Faget the month earlier, all four men admitted quite frankly that the claims about the weight savings were “too optimistic.” Owen Maynard remembers that he and his colleagues initially viewed the LOR concept as “the product of pure theorists' deliberations with little practicality.” In essence, they agreed with Faget's charge, though they did not come out and say it, that Houbolt's figures did “lie.” The STG engineers believed that in advertising the earth-weight savings of LOR and the reduction in the size of the booster needed for the lunar mission, Houbolt and the others were failing to factor in, or they were at least greatly underestimating, the significant extra complexity, and thus added weight, of the systems and subsystems that LOR's modular spacecraft would require.⁴⁸

This criticism was central to the early skepticism toward the LOR concept both inside and outside the STG. Even Marshall's Wernher von Braun initially shared the sentiment: "John Houbolt argued that if you could leave part of your ship in orbit and don't soft land all of it on the moon and fly it out of the gravitational field of the moon again, you can save takeoff weight on earth." "That's pretty basic," von Braun recalled later in an oral history. "But if the price you pay for that capability means that you have to have one extra crew compartment, pressurized, and two additional guidance systems, and the electrical supply for all that gear, and you add up all this, will you still be on the plus side of your trade-off?" Until the analysis was done (and some former NASA engineers still argue today that "this trade-off has never been realistically evaluated"), no one could be sure. Many NASA people suspected that LOR would prove far too complicated. "The critics in the early debate murdered Houbolt," von Braun remembered sympathetically.⁴⁹

Houbolt recalls this January 1961 meeting with the men from the STG as a "friendly, scientific discussion." He, Brown, and the others did what they could to counter the argument that the weight of a modular spacecraft would prove excessive. Using an argument taken from automobile marketing, they stated that the lunar spacecraft would not necessarily have to be "plush"; an "economy" or even "budget" model might be able to do the job. Houbolt offered as an example one of John Bird's lunar bugs, "a stripped-down, 2,500-pound version in which an astronaut descended on an open platform,"⁵⁰ but the STG engineers did not take the budget model idea seriously. In answer to the charge that a complicated modular spacecraft would inevitably grow much heavier than the LOR advocates had been estimating, Houbolt retaliated with the argument that the estimated weight of a direct-ascent spacecraft would no doubt increase during development, making it an even less competitive option in comparison with rendezvous.

But in the end, the substantive differences between the two groups of engineers went out the window. All Houbolt could say to the STG representatives was "you don't know what you're talking about," and all they could say to him was the same. "It wasn't a fight in the violent sense," reassures Houbolt. "It was just differences in scientific opinion about it."⁵¹

Whether the skeptical response to that day's arguments in favor of LOR was indicative of general STG sentiment in early 1961 has been a matter of some serious behind-the-scenes debate among the NASA participants. Houbolt has argued that the STG consistently opposed LOR and had to be convinced *from the outside*, by Houbolt himself, after repeated urgings, that it was the best mission mode for a lunar landing. Leading members of the STG, notably Gilruth and Faget, have argued that was not really the case. They say that the STG was too busy preparing for the Mercury flights to think seriously about lunar studies; they began considering such missions only after Kennedy's commitment. Gilruth recalls that when Houbolt first approached him "with some ideas about rendezvousing Mercury capsules in earth orbit" as "an exercise in space technology," he did in fact react

Enchanted Rendezvous: The Lunar-Orbit Rendezvous Concept

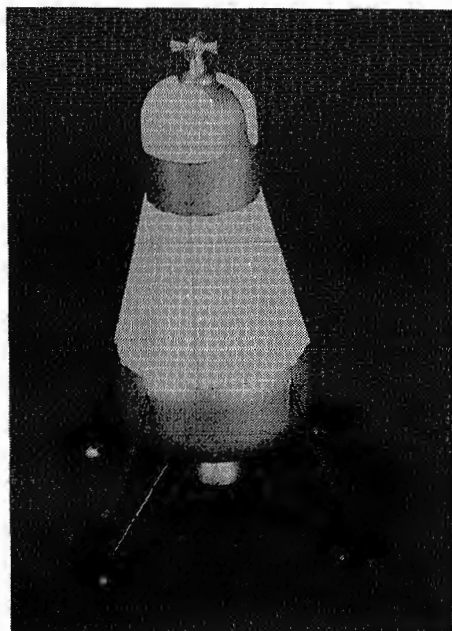

L-61-6790

Looking like a birdie for a badminton game, this early lunar excursion model was proposed by Langley researchers in the spring of 1961 for the suggested Project MALLIR (Manned Lunar Landing Involving Rendezvous).

negatively. It was a “diversion from our specified mission” according to Gilruth and, therefore, not something about which he as the head of Project Mercury then had any time on which to reflect.⁵²

According to Gilruth, he did not know of Houbolt’s interest in LOR until early 1961. By that time, NASA had begun studying the requirements of a manned lunar landing through such committees as the Manned Lunar Landing Task Group chaired by George Low (the Low Committee). The STG, although still overwhelmed with work, did its best to follow suit. When it did begin serious consideration of a lunar program, especially of landing men on the moon, LOR gained “early acceptance . . . notwithstanding the subsequent debates that erupted in numerous headquarters committees.”⁵³

“I was very much in favor of that mode of flight to the moon from the very beginning,” Gilruth has since claimed. “I recall telling our people that LOR seemed the most promising mode to me—far more promising than either the direct ascent or the earth orbital rendezvous modes.” The most important thing in planning for a manned lunar program was to minimize the risk of the landing operation. Thus, LOR was the best of the contending modes because it alone permitted the use of a smaller vehicle specifically designed for the job. In Gilruth’s view, he was always encouraging to Houbolt. In his estimation, he felt all along that “the Space Task Group would be the key in carrying the decision through to the highest echelons of NASA” and that, “of course, this proved to be the case.”⁵⁴

Spaceflight Revolution

Although Houbolt was not the first to foresee the advantages of a moon landing via LOR, his total commitment and crusading zeal won the support of key people in NASA.



L-62-5208

Houbolt accepts very little of these *ex post facto* assertions; indeed, he violently disagrees with them. He points out that on several occasions in late 1960 he had briefed leading members of the STG about LOR and that Gilruth had to know his ideas. According to Houbolt, the STG had ignored and resisted his calculations as too optimistic and continued to ignore and resist them while insisting on the development of the large Nova boosters. As evidence, Houbolt points to many subsequent incidents in which his ideas were summarily discounted by the STG and to various statements of resistance from key STG members. One such statement came from Gilruth in an official letter as late as September 1961. "Rendezvous schemes are and have been of interest to the Space Task Group and are being studied," Gilruth informed NASA headquarters on 12 September. "However, the rendezvous approach itself will, to some extent, degrade mission reliability and flight safety." Rendezvous schemes such as Houbolt's "may be used as a crutch to achieve early planned dates for launch vehicle availability," Gilruth warned. Their advocates propose them "to avoid the difficulty of developing a reliable Nova class launch vehicle."⁵⁵

Houbolt felt strongly that if he could just persuade Gilruth's people to do their homework on rendezvous, "then they too would become convinced of its merits." But for months he could not get them, or anyone else, to do that. LOR met with "virtually universal opposition—no one would accept it—they would not even study it." In Houbolt's words, "my perseverance, and solely mine" caused the STG and various other groups finally to study and

Enchanted Rendezvous: The Lunar-Orbit Rendezvous Concept

realize “the far-sweeping merits of the plan.” “My own in-depth analysis, ... my crusading, ... paved the way to the acceptance of the scheme.”⁵⁶

In early 1961, when the Low Committee announced its plan for a manned lunar landing and its aspiration for that bold mission to be made part of Project Apollo, NASA still appeared to be resisting LOR. In outlining the requirements for a manned lunar flight, the committee’s chief recommendation was to focus on the direct approach to the moon, thus leaving rendezvous out; LOR was not discussed at all. Low remembers that during the time of his committee’s deliberations, he asked one of the committee members, E. O. Pearson, Jr., to visit John Houbolt at Langley and “to advise the Committee whether we should give consideration to the Lunar Orbit Rendezvous Mode.” Pearson, the assistant chief of the Aerodynamics and Flight Mechanics Research Division at NASA headquarters, returned with the answer, “No,” LOR “was not the proper one to consider for a lunar landing.” A rendezvous 240,000 miles from home, when rendezvous had never been demonstrated—Shepard’s suborbital flight had not even been made yet—seemed, literally and figuratively, “like an extremely far-out thing to do.”⁵⁷

Thus the Low Committee in early 1961, recognizing that it would be much too expensive to develop and implement more than one lunar landing mission mode, made its “chief recommendation”: NASA should focus on direct ascent. “This mistaken technical judgment was not Houbolt’s fault,” Low admitted years later, “but rather my fault in trusting a single Committee member instead of having the entire Committee review Houbolt’s studies and recommendations.”⁵⁸

Mounting Frustration

Everything that happened in the first months of early 1961 reinforced John Houbolt’s belief that NASA was dismissing LOR without giving it due consideration. On 20 January, Houbolt gave another long talk at NASA headquarters on rendezvous. In this briefing, he displayed analysis showing a manned lunar landing using Saturn rockets and outlined a simplified rendezvous scheme that had been devised by Art Vogeley and Lindsay J. Lina of the Guidance and Control Branch of Langley’s Aero-Space Mechanics Division. He also mentioned preliminary ideas for the development of fixed-base simulators by which to study the requirements for manned lunar orbit, landing, and rendezvous.⁵⁹ On 27 and 28 February, NASA held an intercenter meeting on rendezvous in Washington, but no LOR presentation was made by Houbolt or anyone else. As if by political consensus, the subject was not even brought up. This prompted one concerned headquarters official, Bernard Maggin from the Office of Aeronautical and Space Research, to write Houbolt a memo commenting on NASA’s, and especially the STG’s, lack of consideration for LOR.⁶⁰

Spaceflight Revolution

Institutional politics was involved in the unfolding lunar landing mission mode debate. The politics centered around the concern over where the work for the manned lunar program was going to be done. The organizations involved in building the big rockets were interested in direct ascent, which required the giant Nova, and in EOR, which required two or more Saturns per mission. Abe Silverstein, the director of the Office of Space Flight Programs at NASA headquarters, was working primarily from his experience as the former head of Lewis Research Center, which was the old NACA propulsion research laboratory now heavily involved in rocket development, so he naturally favored direct ascent. Wernher von Braun had to be thinking about the best interests of his Marshall Space Flight Center, which was primarily responsible at that time for developing the Saturns.⁶¹ For the most part, the management staff of Langley kept out of these debates. No matter which mission mode was implemented, Langley researchers and wind tunnels would have plenty of work to do to support the program.⁶²

In some articles and history books on Project Apollo, LOR has been called a pet concept of Langley, but that was not the case. Even within Langley, LOR was embraced only by a small but vocal minority. Langley management did not get behind LOR until after the STG and the rest of NASA did. The personal opinion of Langley Director Floyd Thompson, as well as that of most of his senior staff, mirrored that of the STG: LOR was too complicated and risky. Direct ascent or EOR was the better choice.⁶³

Although a brilliant engineering analyst and an energetic advocate of the causes he espoused, Houbolt was not an overly shrewd behind-the-scenes player of institutional politics. Faced with the impasse of early 1961, his first instinct was simply to find more informed retorts to the criticisms he had been hearing. So, with the help of Brown, Vogeley, Michael, Bird, Kurbjun, and a few others, he developed elaborate and detailed studies of the lunar landing mission he envisioned along with extensive analyses of weight savings. Somehow, he felt, he must find a way to circumvent the problem and convince the agency that it was making a big mistake by dismissing LOR.

On 19 April 1961, Houbolt was to give another briefing on rendezvous to the STG. In an effort to package his argument more convincingly, he created an “admiral’s page.” This was a short, visually convenient summary for “the admiral” designed to save him wading through a long report. For his STG briefing, Houbolt put 16 pages of charts, data plots, drawings, and outlined analyses—taken from his own analysis as well as material supplied by Langley’s John Bird, Max Kurbjun, and Art Vogeley—onto one 17 × 22-inch foldout sheet. The title of his foldout was “Manned Lunar Landing Via Rendezvous” and on its cover was a telescopic photograph of the moon. Several important people attending the meeting received a copy of the foldout which helped them follow Houbolt’s talk more closely.⁶⁴

As had been the case in Houbolt’s earlier presentations, this one also dealt with both EOR and LOR, but it had a clearly stated preference

Enchanted Rendezvous: The Lunar-Orbit Rendezvous Concept

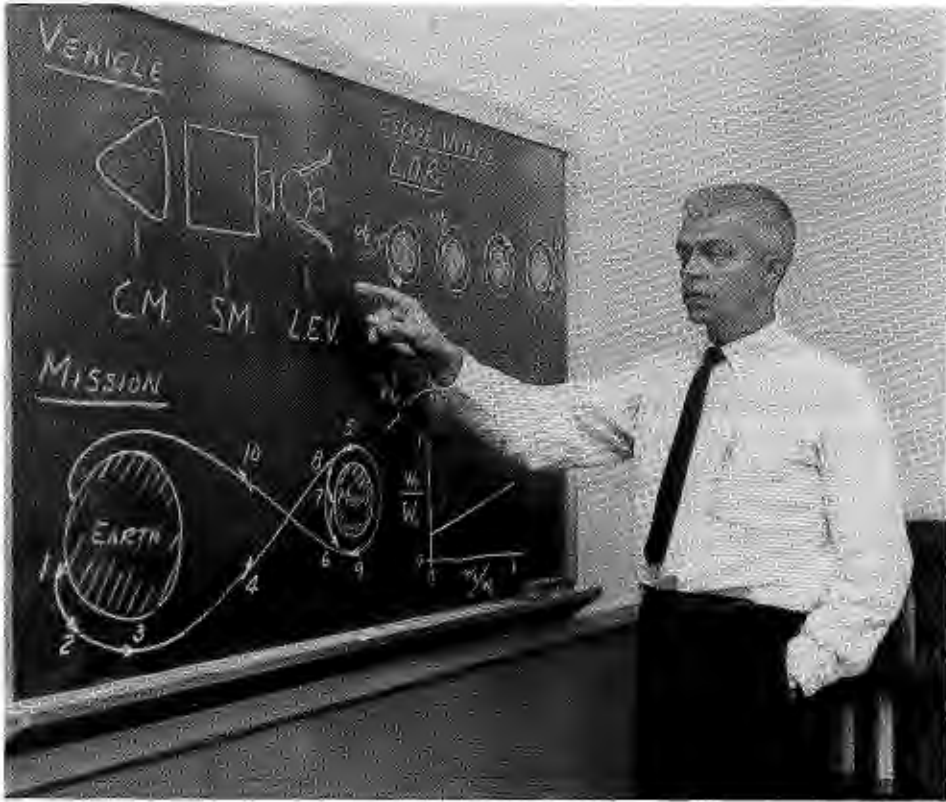

L-62-5849

Houbolt explains the critical weight-saving advantage of the LOR scheme. Because the lunar excursion vehicle ("L.E.V.") in Houbolt's plan weighed only 19,320 pounds, compared to 82,700 pounds for the lander required for direct ascent or EOR, the total weight that must be boosted to earth escape could be reduced by more than half using LOR.

for LOR. In this talk, however, Houbolt advocated for the first time two specific projects for which he supplied project names and acronyms. The first of these ("Project 1") he called "MORAD"—Manned Orbital Rendezvous and Docking. This was his old idea for a modest flight "experiment" follow-on to Mercury that would "establish confidence" in manned rendezvous techniques. An unmanned payload from a Scout rocket would serve as a target vehicle for a maneuvering Mercury capsule in earth orbit. The second of the projects ("Project 2") he called "MALLIR"—Manned Lunar Landing Involving Rendezvous. This contained the essence of the controversial LOR scheme.⁶⁵

Spaceflight Revolution

In the last box of his foldout, Houbolt listed his recommendations for "Immediate Action Required." For MORAD, he wanted NASA to give a quick go-ahead so that Langley could proceed with a work statement preparatory to contracting with industry to do a study. For MALLIR, he wanted NASA "to delegate responsibility to the Space Task Group" so that the STG would have to give "specific and accelerated consideration" to the possibility of including rendezvous as part of Project Apollo. In place of the STG's apparent resistance to his rendezvous ideas and its current discretionary freedom to treat the matter of rendezvous as part of Apollo on a will-also-consider basis, he wanted a NASA directive that made rendezvous integral to an accepted project. Houbolt wanted something that would make the STG, finally, give rendezvous the attention it merited. "I simply wanted people to study the problems and look at [them], and then make a judgment, but they wouldn't even do that," Houbolt remembers with some of his old frustration. "It was that strange a position."⁶⁶

Nothing came immediately from either one of his proposals. Again, the reaction seemed to him to be mostly negative, as if the STG still wanted no part of his ideas. His frustration mounted. "I could never find a real answer to why they wouldn't even consider it," Houbolt laments. Perhaps it was the not-invented-here syndrome, perhaps it was just because he was an "outsider" who was "rocking the boat on their own thinking, and they didn't want anybody to do that,"⁶⁷ or perhaps the STG was just not prepared to think seriously about such an incredibly bold and seemingly treacherous idea when they were still not even sure that they would be able to make their own Mercury program a complete success. Mercury "was proving so troublesome that rendezvous, however simple in theory, seemed very far away."⁶⁸

At this April 1961 briefing, however, a solitary STG engineer did demonstrate a clear and exceptional interest in Houbolt's rendezvous analysis. James Chamberlin approached Houbolt after the meeting and asked him for an extra copy of the foldout sheet and "for anything else he had on rendezvous." Interestingly, both Houbolt and Chamberlin recall Chamberlin telling him that he had known about Langley's rendezvous work but this was the first time he had heard any of the details about the lunar-orbit version.⁶⁹ One might indeed wonder then how widely the information from Houbolt's previous talks had spread within the STG. It seems significant that Chamberlin was not one of Gilruth's old-time associates from the NACA; he was one of the relative newcomers.*

President Kennedy's Commitment

Houbolt's April briefing to the STG came at the end of a humbling week for America. On 12 April the Soviets sent the first human into space,

* The former chief of design for the Avro Arrow aircraft, Chamberlin had been recruited by the STG in late 1959.

Enchanted Rendezvous: The Lunar-Orbit Rendezvous Concept

cosmonaut Yuri Gagarin, beating the United States in the second leg of the space race. Three days later, with President Kennedy's hesitant approval, a confused invasion force prepared by the CIA landed at Cuba's Bay of Pigs only to be driven back quickly by an unexpectedly efficient army of 20,000 led by communist Fidel Castro. Pierre Salinger, Kennedy's articulate press secretary, later called this period "the three grimmest days" of the Kennedy presidency. This national crisis proved in some ways to be more urgent than even the troubled aftermath of Sputnik.⁷⁰

Up to this time, NASA had been preparing for a lunar landing mission as its long-term space goal. Some NASA visionaries, such as George Low, wanted to go to the moon sooner rather than later and were working to convince NASA leadership, now headed by a new administrator, James E. Webb, that such a program should be pushed with the politicians. Not all the politicians needed to be pushed. Most notably, Vice-President Lyndon B. Johnson was pressing NASA for a more ambitious space agenda that included a lunar landing program.⁷¹ President Kennedy, however, needed to be convinced. The one-two punch of the Gagarin flight and Bay of Pigs fiasco followed by the welcome relief and excitement of Alan Shepard's successful Mercury flight on 5 May was enough to persuade the president. *Sputnik 1* and *2* had taken place in the previous Republican administration and had helped the dynamic young senator from Massachusetts nose by Eisenhower's vice-president, Richard M. Nixon, in the 1960 election. Now, in just a month, Kennedy's "New Frontier" had itself been undermined by crisis. Something had to be done to provoke the country into rebounding from its recent second-place finishes and national humiliations.⁷² On 25 May, John Kennedy announced that American astronauts would be first to land on the moon.

Houbolt's First Letter to Seamans

Six days before Kennedy's historic announcement, and unaware that it was coming, John Houbolt shot off "a hurried non-edited and limited note" of three single-spaced pages to Bob Seamans. Confident from past meetings that Associate Administrator Seamans was greatly interested in the subject of rendezvous, Houbolt took the liberty of cutting through several organizational layers to communicate with him directly.

Houbolt's message was straightforward and not overly passionate: the situation with respect to the development of new launch vehicles was "deplorable." The Saturns "should undergo major structural modifications" and "no committed booster plan" beyond Saturn was in place. Furthermore, NASA was still not attending to the use of rendezvous in the planned performance of the Apollo mission. "I do not wish to argue" whether "the direct way" or "the rendezvous way" is best, Houbolt reassured Seamans. But "because of the lag in launch vehicle developments," it appeared to

Spaceflight Revolution

him that “the only way that will be available to us in the next few years is the rendezvous way.” For this reason alone Houbolt believed that it was “mandatory” that “rendezvous be as much in future plans as any item, and that it be attacked vigorously.”⁷³ If NASA researchers continued to dismiss LOR totally as they had been doing, Houbolt knew that someday they would be sorry.

If Houbolt had known that an ad hoc task group at NASA headquarters was at that moment in the midst of concluding that rendezvous had no place in the lunar landing program, his letter to Seamans might have been more urgent. But nothing in his letter suggests that Houbolt knew anything about the meetings of the Fleming Committee. Established by Seamans on 2 May, the job of this committee was to determine, in only four weeks, whether a manned lunar landing was in fact possible and how much it would cost. Chaired by NASA’s assistant administrator for programs, William A. Fleming, who—unlike George Low—was known to be neutral on the ideas of both a moon landing and the method for accomplishing it, this committee eventually recommended a lunar landing program based on a three-stage Nova. In essence, the Fleming Committee “avoided the question of rendezvous versus direct ascent.” Seeing “no reason to base its study on a risky and untried alternative”—and apparently not recognizing that using a huge and unproven launch vehicle was also “risky and untried”—the committee spent all four weeks trying to choose between solid-fuel and liquid-fuel propellants for the Nova stages.⁷⁴

Houbolt and the other LOR advocates at Langley would have been dismayed. To them, development of the rendezvous concept was “the obvious thing” to do before a lunar mission, but to so many others, space rendezvous was still an absurdly complicated and risky proposition. Some, like Bob Seamans, were not sure what to think. On 25 May, after hearing President Kennedy’s speech, the associate administrator called for the appointment of yet another ad hoc committee, this one “to assess a wide variety of possible ways for executing a manned lunar landing.”⁷⁵ Bruce T. Lundin, an associate director of NASA Lewis, would chair this new committee.

Whether Houbolt’s letter, written nearly a week before, directly caused Seamans to create the Lundin Committee is not certain. But the letter surely was a contributing factor as two pieces of circumstantial evidence appear to indicate.* First, in explaining why a new task force was necessary,

* Houbolt believes that Seamans created the Lundin Committee solely in response to his letter. “The story I got [from somebody else at NASA headquarters] was that my letter jolted Seamans, and he got up at five o’clock in the morning, got on the phone, called several people and said, ‘Be at my office at seven o’clock’. . . . And then they formed the Lundin Committee.” No documents exist to back up Houbolt’s version of the story. Based on what Seamans has said about the formation of the Lundin Committee, there is no doubt that Houbolt’s letter did contribute directly to its establishment but perhaps not as exclusively as Houbolt has heard. (Houbolt interview with author, Williamsburg, Va., 24 Aug. 1989, transcript, p. 31, Langley Historical Archives.)

Enchanted Rendezvous: The Lunar-Orbit Rendezvous Concept

Seamans explained to his director of Advanced Research Programs (Ira H. Abbott) and his director of Launch Vehicle Programs (Don R. Ostrander) that the Fleming Committee was finding it necessary “to restrict its considerations to a limited number of techniques by which it is feasible to accomplish the mission in the shortest possible time.” Consequently, “numerous other approaches”—and Seamans specifically mentioned the use of rendezvous—were not currently being assessed. Second, Seamans, a busy man, wrote to Houbolt on 2 June, thanking him for his comments and reassuring the distressed Langley researcher that “the problems that concern you are of great concern to the whole agency.” NASA headquarters had just organized “some intensive study programs,” Seamans informed him, without mentioning the Fleming or Lundin committees by name. These programs “will provide us a base for decisions.”⁷⁶

Some historians have said that Seamans made sure that Houbolt was on the Lundin Committee; this is untrue. Houbolt was not an official member of that committee. Laurence K. Loftin, Jr., was Langley’s representative, although he apparently did not attend all the meetings. Houbolt did meet with and talk to the committee several times, and in his view, was “the real Langley representative” because Loftin did not attend as regularly as he.⁷⁷

The idea behind the Lundin Committee, at least as originally conceived by Seamans, was to take an open-minded look into the alternative “modes” for getting to the moon. Primarily, Seamans wanted the committee to examine those options involving “mission staging by rendezvous” and “alternative Nova vehicles.” In the committee’s initial meeting, however, that original objective seems to have been seriously compromised. Larry Loftin, who attended the opening meeting in early June 1961, remembers that Bob Seamans came in the first day and “sort of gave us our marching orders.” Then Abe Silverstein, director of the Office of Space Flight Programs at NASA headquarters, came in to address the men:

Well, look fellas, I want you to understand something. I’ve been right most of my life about things, and if you guys are going to talk about rendezvous, *any kind of rendezvous*, as a way of going to the moon, forget it. I’ve heard all those schemes and I don’t want to hear any more of them, because we’re not going to the moon using any of those schemes.

With those words of warning, which completely violated the reason for forming the committee in the first place, Silverstein “stomped out of the room.”⁷⁸

To its credit, the Lundin Committee disregarded Silverstein’s admonition and considered a broad range of rendezvous schemes. With a complete analysis of the rendezvous problems by Houbolt and assorted insights from invited analysts both from inside and outside NASA, the group looked into mission profiles involving rendezvous in earth orbit, in transit to the moon, in lunar orbit before landing, in lunar orbit after takeoff from the moon, and in both earth and lunar orbit. The committee even considered the idea of

Spaceflight Revolution

a lunar-surface rendezvous. This involved launching a fuel cache and a few other unmanned components of a return spacecraft to the moon's surface—a payload of some 5000 pounds—and then landing astronauts separately in a second spacecraft whose fuel supply would be exhausted just reaching the moon. The notion, as absurd as it now sounds, was for the landed astronauts to leave their craft and locate the previously deposited hardware (homing beacons previously landed as part of the unmanned Surveyor program were to make pinpoint landings possible) and then to assemble and fuel a new spacecraft for the return trip home. The spacecraft would be checked out by television monitoring equipment before sending men from earth to the landing area via a second spacecraft.

Houbolt thought this was “the most harebrained idea” he had ever heard. In the committee's final “summary rating” of the comparative value of the various rendezvous concepts, however, lunar-surface rendezvous finished only slightly lower than did Houbolt's LOR. One anonymous committee member (most likely the JPL representative) chose lunar-surface rendezvous as his first choice.⁷⁹

As Houbolt remembers bitterly, the Lundin Committee “turned down LOR cold.” In the final rating made by the six voting committee members (Loftin voted, but Houbolt did not), it finished a distant third—receiving no first-place votes and only one second-place vote. Coming in far ahead of LOR were two low-earth-orbit rendezvous schemes, the first one utilizing two to three Saturn C-3 boosters and the other involving a Saturn C-1 plus the Nova. Both were concepts strongly favored by NASA Marshall staff, who by this time had grabbed onto the idea of EOR for its potential technological applications to the development of an orbiting space station.⁸⁰

Houbolt was devastated when he heard the results. To have LOR placed on the same level as the ridiculous lunar-surface rendezvous was especially insulting. He had given the Lundin Committee his full-blown pitch complete with foldout sheet and slides. “They'd say, ‘That sounds pretty good, John,’ but then the next morning the same guys would come up and say, ‘John, that's no good; we don't like it at all.’” For Houbolt, this perverse reaction was hard to understand.⁸¹ Loftin reflects on the general fear and pessimism about LOR that ultimately ruled the committee:

We thought it was too risky. Remember in 1961 we hadn't even orbited Glenn yet. We certainly had done no rendezvous yet. And to put this poor bastard out there, separate him in a module, let him go down to the surface, and then fire him back up and expect him to rendezvous. He didn't get a second chance; it had to be dead right the first time. I mean that just seemed like a bit much.

Loftin and the others believed—incorrectly—that LOR offered no possibility for a rescue mission. In earth orbit, if something went wrong, NASA still might be able to save its astronauts. Loftin felt along with the others that the idea of LOR was just “kind of absurd.”⁸² The Lundin Committee could

Enchanted Rendezvous: The Lunar-Orbit Rendezvous Concept

not bring itself to acknowledge that all the other mission-mode options entailed greater risks.

As discouraged as John Houbolt was after the Lundin Committee's recommendation, the situation would soon become worse. On 20 June, 10 days after the Lundin Committee delivered its blow, Bob Seamans formed yet another task force. This one was chaired by his assistant director of launch vehicle programs, Donald H. Heaton. Following up on the summary ratings and recommendations of the Lundin Committee, Seamans asked Heaton's group to focus on EOR and to establish the program plans and the supporting resources needed to accomplish the manned lunar landing mission using rendezvous techniques.⁸³ Trying to stay within those guidelines, Heaton refused to let Houbolt, an official member of this committee, mention LOR.

Houbolt felt he was caught in a bizarre trap of someone else's making. He was one of the strongest believers in rendezvous in the country, and that meant either kind of rendezvous. Just days before the Heaton Committee was formed, he had returned from France, where he had given a well-received formal presentation on EOR and LOR at an international spaceflight symposium.⁸⁴ He and his Langley associates had done the analysis, and they knew that LOR would work better than EOR for a manned lunar landing. He pleaded with Heaton to study LOR as well as EOR. Heaton simply answered, "We're not going to do that, John. It's not in our charter." "If you feel strongly enough about it," Heaton challenged, "write your own lunar-orbit report."⁸⁵

Houbolt eventually did just that. As for Heaton's own report, which was published in late August, it concluded that rendezvous—EOR, that is—"offers the earliest possibility for a successful manned lunar landing." In postulating the design of the spacecraft that would make that type of lunar mission, however, the Heaton Committee previewed a baseline configuration that Houbolt regarded as a "beast." It involved "some five different pieces of hardware that were going to be assembled in the earth-orbit rendezvous," Houbolt remembers. "It was a great big long cigar." In his opinion, such an unwieldy concept "would hurt the cause of rendezvous." He feared NASA engineers, especially in the STG, would read the Heaton report and say, "Well, we knew it all the time: these rendezvous guys are nuts."⁸⁶

Or they were being driven nuts. For many NASA engineers, the summer of 1961 was the busiest summer of their lives; it certainly was the busiest of John Houbolt's. "I was living half the time in Washington, half the time on the road, dashing back and forth."⁸⁷ In mid-July he was to be in Washington again, to give a talk at the NASA/Industry Apollo Technical Conference. This was an important meeting that was to include about 300 potential Project Apollo contractors. It was so important that Langley management in association with the STG, in the tradition of NACA/NASA annual inspections, was holding a formal rehearsal of all its presentations prior to the conference.

Spaceflight Revolution

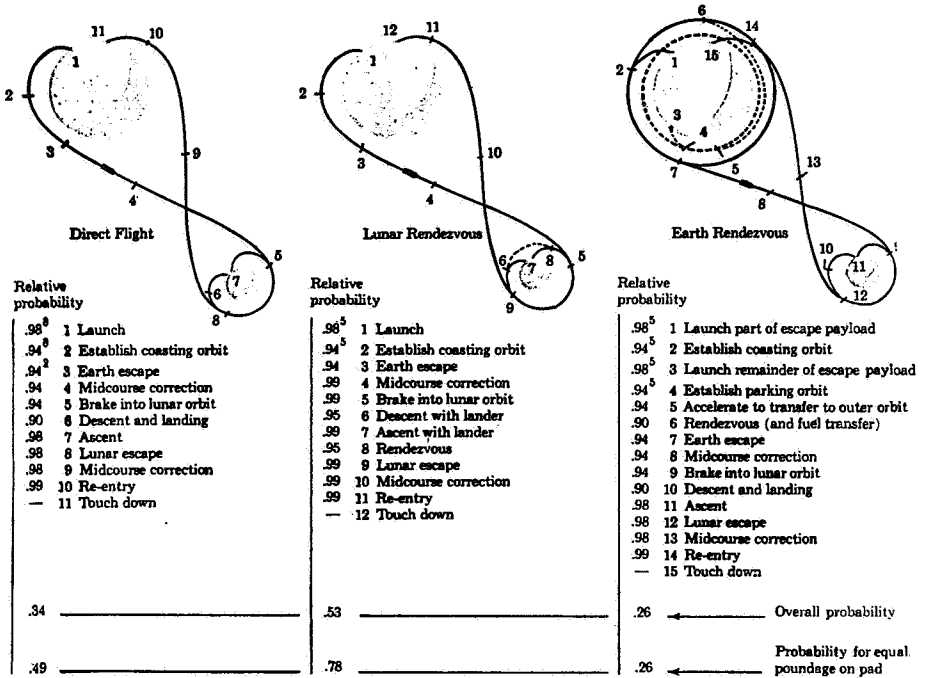

In making his pitch to various NASA committees and study groups in 1961 and 1962, Houbolt used this viewgraph comparing the propulsion steps involved in direct flight, LOR, and EOR, thereby demonstrating the much higher probability of success with LOR.

Houbolt was to give his talk at the end of rehearsals because he had another NASA meeting earlier that day in Washington. "I was to rush out to the airport at Washington National, get on the airplane, they were to pick me up here and then bring me to where they were having the rehearsals." However, when he arrived breathless at the airport, the airplane could not take off. In refueling the aircraft, the ground crew had spilled fuel on one of the tires and the Federal Aviation Administration (FAA) would not let the plane take off until the tire had been changed. That made Houbolt a little late and the STG member waiting for him a little impatient. "They dashed me back to the conference room," and with all of the other rehearsals finished, "everybody was sort of twiddling their thumbs," complaining, "Where the hell is this Houbolt?"⁸⁸

With a brief apology, Houbolt moved right into his talk. Until the end, he purposefully said nothing about LOR; he spoke only about rendezvous in general. Then he showed three or four final slides. "There is a very interesting possibility that rendezvous offers," Houbolt ventured, feeling like a lawyer who was trying to slip in evidence that he knew the judge would

Enchanted Rendezvous: The Lunar-Orbit Rendezvous Concept

not allow, "and that is how to go to the moon in a very simplified way." He then described the whole LOR concept.⁸⁹

People listened politely and thanked him when he had finished. "That's a damn good paper, John," offered Langley Associate Director Charles Donlan. "But throw out all that nonsense on lunar-orbit rendezvous." Houbolt remembers that Max Faget and several other members of the STG piped in with the same advice.⁹⁰

The Lundin Committee had been strike one against Houbolt: LOR had been turned down cold. The Heaton Committee had been strike two: LOR would not even be considered. Houbolt's rehearsal talk was in a sense a third strike. But at least all three had been swinging strikes, so to speak. Houbolt had used each occasion to promote LOR, and he had given his best effort each time. Furthermore, he was allowed a few more times at bat. An inning was over, but the game was not.

Houbolt's next time at bat came quickly, in August 1961, when he met with the Golovin Committee, which was yet another of Bob Seamans' ad hoc task forces. Established on 7 July 1961, this joint Large Launch Vehicle Planning Group was co-chaired by Nicholas E. Golovin, Seamans' special technical assistant, and Lawrence L. Kavanau of the DOD. This committee was to recommend not only a booster rocket for Project Apollo but also other launch vehicle configurations that would meet the anticipated needs of NASA and the DOD.⁹¹

Nothing in the committee's charge, which was to concern itself only with large launch vehicle systems, necessitated an inquiry into the LOR scheme; however, Eldon W. Hall, Harvey Hall, and Milton W. Rosen (all of the Office of Launch Vehicle Programs) and members of the Golovin Committee asked that the LOR concept be presented for their consideration in the form of a mission plan.⁹² This was to be done as part of a systematic comparative evaluation of three types of rendezvous operations (earth-orbit, lunar-orbit, and lunar-surface) and direct ascent for manned lunar landing. The Golovin Committee assigned the study of EOR to Marshall Space Flight Center, lunar-surface rendezvous to JPL, and LOR to Langley. The NASA Office of Launch Vehicle Programs would itself provide the information on direct ascent.⁹³

This commitment to a comparative evaluation of the mission modes, including LOR, constitutes a critical turning point in the torturous intellectual and bureaucratic process by which NASA eventually decided upon a mission mode for Project Apollo. The Golovin Committee would not conclude in favor of LOR. Its final somewhat vacillating recommendation, made in mid-October, was in favor of a hybrid rendezvous scheme that combined aspects of both EOR and LOR. However, the committee's preference was clearly for some form of rendezvous. Lunar-surface rendezvous, JPL's pet project, had been ruled out, and direct ascent was fading from the realm of possibility. The engineering calculations showed clearly that any single rocket that had to carry all the fuel necessary for completing the entire lunar mission

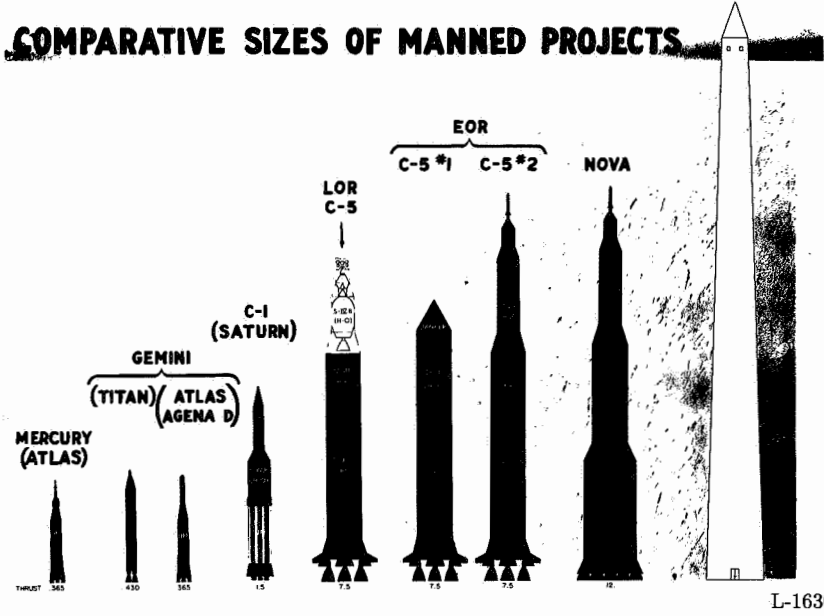

COMPARISON OF LANDER SIZES

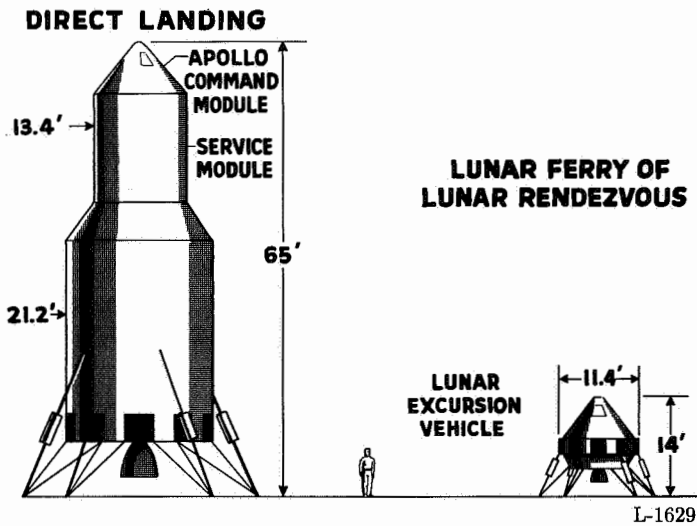

By using drawings that compared the sizes of rockets (top) and lunar landing vehicles (bottom), Houbolt tried to convince the nonbelievers that LOR was the only way to go to the moon.

Enchanted Rendezvous: The Lunar-Orbit Rendezvous Concept

was not a realistic option—especially if the mission was to be accomplished anytime close to President Kennedy’s deadline.

For Houbolt and the other LOR advocates, the work of the Golovin Committee meant the first meaningful opportunity to demonstrate the merits of LOR in a full-blown comparison with the other viable options. This consideration was the opportunity that Houbolt had been asking for in all of his previously unsuccessful briefings. When he appeared before the Golovin Committee in August, “they were damn impressed.” They asked him, to his delight, whether the STG knew all about LOR. Golovin turned to Aleck C. Bond, the STG’s representative on the committee, and asked him to go back to Langley and “check with your fellows on what they’re doing about this.” A few days later, Houbolt was back in front of the STG talking to them about the same thing that they had told him not to talk about just the month before.⁹⁴

The STG, with the Shepard and Grissom flights at least behind them and the Golovin Committee now urging them to study rendezvous, started to reconsider. Thus far, as other historians have noted, the STG had “seen little merit in any form of rendezvous for lunar missions,” but reserved “its greatest disdain for the lunar orbit version.” Now, at least, some STG engineers were showing solid interest. In early September 1961, Jim Chamberlin, who had asked for Houbolt’s material after hearing the proposals for MORAD and MALLIR five months earlier, talked to Gilruth about an LOR plan for a lunar landing program and for a preparatory three-flight rendezvous experiment, both of which sounded similar to the ideas Houbolt had been promoting. Although Gilruth was not convinced of the merits of such a scheme, he was open to their further evaluation.⁹⁵

Chamberlin’s notion derived in part from the STG’s August 1961 proposal for an accelerated circumlunar program; this proposal appeared as an appendix to its “Preliminary Project Development Plan for an Advanced Manned Space Program Utilizing the Mark II Two-Man Spacecraft.” In essence, the larger document called for the start of what became known as Project Gemini, the series of two-man rendezvous and docking missions in earth orbit that NASA successfully carried out between March 1965 and November 1966. But the idea for Project Gemini, as proposed by Chamberlin at least, must also have had some important connection to Houbolt’s April 1961 MORAD proposal.⁹⁶

A Voice in the Wilderness

During the late summer and early fall of 1961, Houbolt was busily preparing the formal report that the Golovin Committee had requested. Except for his “admiral’s page,” much of the analysis in favor of LOR was still in a loose form. With John Bird, Art Vogeley, Max Kurbjun, and the other rendezvous people at Langley, he set out to document their research

Spaceflight Revolution

findings and demonstrate what a complete manned lunar landing mission using LOR would entail. The result was an impressive two-volume report entitled "Manned Lunar-Landing through Use of Lunar-Orbit Rendezvous." Published by NASA Langley on 31 October 1961, this report promoted what its principal author, John Houbolt, called a "particularly appealing scheme" for performing the manned lunar landing mission.⁹⁷

This extremely thorough document might seem sufficient even for a zealous crusader like Houbolt, but it was not. The Heaton Committee had submitted its final report in August 1961—a report with which Houbolt fervently disagreed. Houbolt took committee chair Heaton up on his remark about submitting his own report.

On 15 November 1961, Houbolt "fired off" a nine-page letter to Seamans with two different editions of his LOR admiral's page attached to it without ever thinking that it might cost him his job. He was again bypassing proper channels, a bold move for a government employee, and appealing directly to the associate administrator. "Somewhat as a voice in the wilderness," Houbolt's letter opened, "I would like to pass on a few thoughts that have been of deep concern to me over recent months." Houbolt's main complaint was about the bureaucratic guidelines that had made it impossible for the Heaton Committee to consider the merits of LOR. "*Do we want to go to the moon or not?*, and, if so, why do we have to restrict our thinking to a certain narrow channel?" He asked: "Why is Nova, with its ponderous size simply just accepted, and why is a much less grandiose scheme involving rendezvous ostracized or put on the defensive?"⁹⁸

"I fully realize that contacting you in this manner is somewhat unorthodox," Houbolt admitted, "but the issues at stake are crucial enough to us all that an unusual course is warranted." Houbolt realized that Seamans might feel that he was "dealing with a crank." "Do not be afraid of this," Houbolt pleaded. "The thoughts expressed here may not be stated in as diplomatic a fashion as they might be, or as I would normally try to do, but this is by choice." Most important was that Seamans hear his heartfelt ideas directly and "not after they have filtered through a score or more of other people, with the attendant risk [that] they may not even reach you."⁹⁹

It took two weeks for Seamans to reply to Houbolt's extraordinary letter. When he did, the associate administrator agreed that "it would be extremely harmful to our organization and to the country if our qualified staff were unduly limited by restrictive guidelines." He assured Houbolt that NASA would in the future be paying more attention to LOR.¹⁰⁰

Seamans also informed him that he had passed his long letter with its attachments on to Brainerd Holmes, who had just replaced Abe Silverstein as head of the Office of Manned Space Flight (recently renamed Space Flight Programs). Unlike Seamans, who apparently was not overly bothered by the letter being sent out of formal organizational channels, Holmes "didn't like it at all" and said so when in turn he passed Houbolt's letter on to George Low, his director of spacecraft and flight missions. Low was more forgiving.

Enchanted Rendezvous: The Lunar-Orbit Rendezvous Concept



L-70-1270

Although he too had been slow to accept the LOR scheme, NASA leader George M. Low eventually became a devout believer not only in LOR but also in the essential role played by Houbolt in its adoption.

Although he conceded that Houbolt probably should have followed standard procedures, he found the basic message “relatively sound.” He, too, felt that “the bug approach” might yet prove to be “the best way of getting to the moon” and that NASA needed to give it as much attention as any other alternative. At the end of the memo to Holmes in which he passed on these feelings, Low recommended that Houbolt be invited to Washington to present in detail Langley’s plan for a manned lunar landing via LOR. Low even went so far as to suggest that Houbolt should be made a member of Holmes’s staff.¹⁰¹

That never happened, but another person who joined Holmes’s staff at this time, Dr. Joseph F. Shea, came to play a major role in supporting Houbolt’s ideas and making the eventual decision in favor of LOR. Shea arrived at NASA the first week of January 1962 as Holmes’s deputy director for spaceflight systems. From 1956 to 1959 the energetic engineer from the Bronx had served as the systems engineer at Bell Laboratories for a radio guidance project involving the Titan I rocket. In 1959 he moved to General Motors, where he ran the advanced development operation for its A. C. Sparkplug Division. His major achievement while in this job was to win a contract for the development of an inertial guidance system for the Titan II.¹⁰²

With NASA, Joe Shea found himself thrust into the job of sorting out the best means of accomplishing the lunar landing mission. During his first days

Spaceflight Revolution

in office, Brainerd Holmes came to see him, with his copy of Houbolt's letter in hand. Shea perused the long letter and was taken down to Seamans' office where Seamans asked him if he thought anything of value could be found in Houbolt's message. Having received an unsure response, Seamans then advised the young systems engineer that NASA really did not know how it was going to go to the moon. Shea answered tactfully, "I was beginning to get that same suspicion."¹⁰³

"Shea didn't know much about what was going on," John Houbolt remembers, but quickly he became informed. Within days of his meeting with Seamans and Holmes about the Houbolt letter, Shea was at Langley for a private conversation with Houbolt and for a general briefing attended by Langley management and the leadership of the STG. Going into the meeting, if Shea had a preference for any one lunar mission mode, it was a weak one for EOR, but after reading Houbolt's letter to Seamans and knowing Seamans' sympathetic reaction to it, Shea was not adverse to other options. Shea was an open-minded man who "prided himself on going wherever the data took him."¹⁰⁴

This time the data took him to LOR. When Houbolt finished his much-practiced pitch, the receptive Shea admitted that the analysis looked "pretty good" to him. The new boy on the block of manned spaceflight then turned to Gilruth, Faget, and other members of the STG and asked them politely if they, too, had been thinking along the lines of LOR. Having gotten the word about the general skepticism to Houbolt's ideas, Shea expected a negative reaction. He did not receive one. Instead, the STG leaders responded in a mildly positive way that signified to Shea, as the discussion continued, that "actually, they had been doing some more thinking about lunar-orbit rendezvous and, as a matter of fact, they were beginning to think it was a good idea."¹⁰⁵

Shea returned to Washington convinced that LOR was a viable option for Apollo and that the next step was for NASA to contract for an even more detailed study of its potential. On 1 March 1962, eight days after astronaut John Glenn's historic three-orbit flight in the Mercury spacecraft *Friendship 7*, NASA named Chance Vought Corporation as the contractor to study spacecraft rendezvous. The firm had on staff one of the original proponents of LOR, Tom Dolan. At Langley on 29 March 1962, a group of researchers led by Houbolt briefed a Chance Vought team on the center's LOR research and mission plan. On 2 and 3 April, Shea presented LOR as a possible mission mode for Apollo in a headquarters meeting that was attended by representatives of all the NASA centers.¹⁰⁶ The final decision to select LOR for Apollo was about to be made.

The LOR Decision

In the months following Houbolt's second letter to Seamans, NASA gave LOR the serious consideration that Houbolt had long been crusading for.

Enchanted Rendezvous: The Lunar-Orbit Rendezvous Concept

To the surprise of many, both inside and outside the agency, the dark-horse candidate became the front runner. Several factors worked in LOR's favor. First, many were becoming disenchanted with the idea of direct ascent because of the time and money required to develop the huge Nova rocket. Second, technical apprehension was growing over how the relatively large spacecraft demanded even by EOR would be able to maneuver to a soft and pinpoint landing on the moon. As Langley's expert on the dynamics of rendezvous, Art Vogeley, has explained, "The business of eyeballing that thing down to the moon really didn't have a satisfactory answer. The best thing about LOR was that it allowed us to build a separate vehicle for landing."¹⁰⁷

The first major group to break camp in favor of LOR was Bob Gilruth's STG, which during the critical months of the Apollo mission mode debate was harried not only with the planning for the first Mercury orbital flight but also with packing and leaving for its new home, the Manned Spacecraft Center in Houston. During an interview in the late 1980s, Houston's Max Faget recalled the details of how the STG Manned Spacecraft Center finally became convinced that LOR was the right choice. By early 1962,

we found ourselves settling into a program that was not easy to run, because so many different groups were involved. In particular, we were concerned about the big landing rocket, because landing on the moon would, of course, be the most delicate part of the mission. The landing rocket's engine, which would be controlled by the astronauts, would have to be throttleable, so that the command-and-service module could hover, and move this way and that, to find a proper place to touch down.

Obtaining that capability meant the need for "a really intimate interface, requiring numerous connections, between the two elements," as well as between Houston and NASA Lewis.

Accordingly, we invented a new proposal for our own and von Braun's approach. It involved a simpler descent engine, called the lunar crusher, which Lewis would do. It wouldn't be throttleable, so the interface would be simpler, and it would take the astronauts down to a thousand feet above the lunar surface. There it would be jettisoned, and it would crash onto the moon. Then there would be a smaller, throttleable landing stage for the last thousand feet, which *we* would do, so that we would be in charge of both sides of that particular interface.

At that point, however, Faget and his colleagues in Texas "ran into a real wall."¹⁰⁸

Initially their thinking had been that the landing would be done automatically with radar and instrument control. Then the astronauts, along with a growing number of NASA engineers (primarily at Langley), began to argue that the astronauts were going to need complete control during the last phases of landing and therefore would require a wide range of visibility from the descending spacecraft. How to provide that visibility "with a

Spaceflight Revolution

landing rocket big enough to get the command-and-service module down to the lunar surface and wide enough to keep it upright” was the problem that Houston began tackling in early 1962 and found very quickly they could not solve. “We toyed with various concepts,” Faget remembers, such as putting a front viewing porch on the outside or a glass bubble on top of the CM similar to the cockpit of a helicopter. But all the redesigns had serious flaws. For example, “the porch would have to be jettisoned before lift-off from the moon, because it would unbalance the spacecraft.” “It was a mess,” Faget admitted. “No one had a winning idea. Lunar-orbit rendezvous was the only sensible alternative.”¹⁰⁹

Houbolt’s role in the STG’s eventual “coming-around” to LOR cannot be described without upsetting someone—or at least questioning the accuracy of someone’s memory. Faget, Gilruth, and others associated with the Manned Spacecraft Center believe that Houbolt’s activities were “useful” but hardly as vital as many others, notably Houbolt himself, believe them to be. “John Houbolt just assumed that he had to go to the very top,” Gilruth has explained, “he never talked to me.” Gilruth maintains that “the lunar orbit rendezvous would have been chosen without Houbolt’s somewhat frantic efforts.” The “real work of convincing the officials in Washington and Huntsville,” he says, was done “by the spacecraft group in Houston during the six or eight months following President Kennedy’s decision to fly to the moon.” Gilruth’s group sold the concept, first to Huntsville and then, together with von Braun, to NASA headquarters. Houbolt’s out-of-channels letter to Seamans was, in Gilruth’s opinion, irrelevant.¹¹⁰

Houbolt calls the STG’s version self-serving “baloney.” He talked to Gilruth or his people many times, and not once did they tell him that they were really on his side. If just one time Gilruth or some other influential officer in the manned space program had said to him, “You can stop fighting. We are now on your side; and we’ll take it from here,” then, Houbolt claims, he would have been satisfied. But they never said that to him, and they certainly did not say it “during the six or eight months” after Kennedy’s speech. In fact, their words always suggested just the opposite. Not until early 1962, after prodding from Joe Shea, did the STG give any indication that it, too, was interested in LOR.¹¹¹

Significantly, the outsiders or third parties to the question of Houbolt’s role in influencing the STG’s position on the mission mode for Apollo tend to side with Houbolt. Bob Seamans remembers the STG showing nothing but disdain for LOR during 1961.¹¹² George Low agrees. To the best of his recollection, “it was Houbolt’s letter to Seamans that brought the Lunar Orbit Rendezvous Mode back into the picture.” Only after that did a group within the STG under Owen Maynard begin to study LOR. “Based on Houbolt’s input” and on the results of the systems engineering studies carried out at the behest of Joe Shea’s Office of Manned Space Flight Systems, “the decision was finally made” about the lunar landing mission mode. “Without a doubt,” in Low’s view, the letter Houbolt sent

Enchanted Rendezvous: The Lunar-Orbit Rendezvous Concept

to Seamans in November 1961 and the discussions at headquarters that it provoked “were the start of bringing LOR into Apollo.”¹¹³

One final piece of testimony from an informed third party supports the importance of Houbolt’s role in convincing the STG of the benefits of LOR. Starting in late 1961, NACA veteran Axel Mattson served as NASA Langley’s technical liaison officer at the Manned Spacecraft Center. Mattson, who was responsible for coordinating the other NASA centers for the first NASA inspection, maintained a small office at the Houston facility for the timely moving of technical information between Langley and Gilruth’s recently removed STG. Mattson’s operation was not high profile, nor was it supposed to be. According to the agreement that had been worked out between Gilruth and Langley Director Floyd Thompson, Mattson was to spend most of his time with the engineers who were working on Mercury problems.¹¹⁴

In early 1962, sometime after the Shea briefing, Langley sent Houbolt to Houston. The purpose of his visit was, in Mattson’s words, “to get the STG people really to agree that [LOR] was the best way to go and to support it.” Mattson took him to practically everyone who had some interest in the mission mode issue, and Houbolt told them about LOR and answered all their questions. At the end of the day, Mattson felt that “it was all over.” “We had the support of the Manned Spacecraft Center” for LOR.¹¹⁵

Significantly, on 6 February 1962, Houbolt and former Langley engineer Charles W. Mathews of the Manned Spacecraft Center gave a joint presentation on rendezvous to the Manned Space Flight Management Council. This council was a special body formed by Brainerd Holmes in December 1961 to identify and resolve difficulties in the manned spaceflight program on a month-to-month basis. In their presentation the two engineers compared the merits of LOR and EOR and clearly favored LOR. Gilruth had telephoned Houbolt personally to ask him to give this talk. In Houbolt’s memory, the invitation was “the first concession” that Gilruth had ever made to him regarding LOR.¹¹⁶

With the STG now firmly behind LOR, its adoption became a contest between the Manned Spacecraft Center in Houston and the Marshall Space Flight Center in Huntsville. Marshall was a bastion of EOR supporters. Von Braun’s people recognized two things: EOR would require the development of advanced versions of Marshall’s own Saturn booster, and the selection of EOR for the lunar landing program would require construction of a platform in earth orbit that could have many uses other than for Apollo. For this reason, space station advocates—who existed in droves at the Alabama facility—were enthusiastic about EOR.¹¹⁷ To this day, many of them feel that EOR would have had the best long-term results.

But von Braun, their own director, would disappoint them. During the spring of 1962, the transplanted German rocket designer made the decision to throw his weight behind LOR. He surprised his staff with this shocking

Spaceflight Revolution



L-66-3090

Taking charge of every situation, Wernher von Braun (second from left) entertains his hosts during a visit to Langley in April 1966. To the far right stand Floyd Thompson and Charles Donlan.

announcement at the end of a day-long briefing given to Joe Shea at Marshall on 7 June 1962:

We at the Marshall Space Flight Center readily admit that when first exposed to the proposal of the Lunar Orbit Rendezvous Mode we were a bit skeptical—particularly of the aspect of having the astronauts execute a complicated rendezvous maneuver at a distance of 240,000 miles from the earth where any rescue possibility appeared remote. In the meantime, however, we have spent a great deal of time and effort studying the four modes [EOR, LOR, and two Direct Ascent modes, one involving the Nova and the other a Saturn C-5], and we have come to the conclusion that this particular disadvantage is far outweighed by [its] advantages. . . .

We understand that the Manned Spacecraft Center was also quite skeptical at first when John Houbolt advanced the proposal of the Lunar Orbit Rendezvous Mode, and that it took them quite a while to substantiate the feasibility of the method and finally endorse it.

Against this background it can, therefore, be concluded that the issue of 'invented here' versus 'not invented here' does not apply to either the Manned Spacecraft Center or the Marshall Space Flight Center; that both Centers have actually embraced a scheme suggested by a third source. . . . I consider it fortunate indeed for the Manned Lunar Landing Program that both Centers, after much soul searching, have come to identical conclusions.

Enchanted Rendezvous: The Lunar-Orbit Rendezvous Concept

The persuasive von Braun then elaborated on “why we do not recommend” the direct ascent and EOR modes, and “why we do recommend the Lunar-Orbit Rendezvous Mode.”¹¹⁸

For Marshall employees and many other people inside NASA, von Braun’s announcement seemed to represent a type of closure, that is, the culmination of a sociopolitical process “when a consensus emerges that a problem arising during the development of a technology has been solved.” In this case, it was a very undemocratic form of closure, coming from von Braun himself, with very little support from his own people. But NASA, of course, was not a democratic organization. For closure to occur and LOR to become the mission mode for Apollo, referendum or consensus was not necessary; it only required that a decision be made and supported by a few key people: von Braun, Bob Gilruth, Bob Seamans, Administrator James Webb, and President Kennedy.¹¹⁹

How von Braun was persuaded is a historically significant matter. Although some questions about his motives remain unanswered, one apparent factor in his conversion was that he understood the necessity of moving ahead with the program if NASA was to meet President Kennedy’s deadline. No progress was possible until the decision about the mission mode was made. Both the Manned Spacecraft Center and Langley’s John Houbolt had worked to convince von Braun to come over to their side. In April 1962 Houbolt sent von Braun several papers prepared at Langley on a lunar landing mission using LOR, including the published two-volume report. Von Braun had requested the papers personally after hearing Houbolt’s presentation at NASA headquarters. Von Braun not only passed copies of the Langley papers to Hermann Koelle in Marshall’s Future Projects Office but also, after making his unexpected announcement in favor of LOR to the stunned crowd of Marshall employees in early June, reciprocated by sending Houbolt a copy of the remarks he had made. This was a noteworthy courtesy. The final sentence of the cover letter asked Houbolt to “please treat this confidentially since no final decision on the mode has yet been made.”¹²⁰

The LOR decision was finalized in the following weeks when the two powerful groups of converts at Houston and Huntsville, along with the original little band of true believers at Langley, persuaded key officials at NASA headquarters, notably Administrator James Webb, who had been holding out for direct ascent, that LOR was the only way to land on the moon by 1969. With the key players now supporting the concept, the NASA Manned Space Flight Management Council announced on 22 June 1962 that it favored LOR. On 11 July, the agency announced that it had selected the mode for Apollo. Webb made the announcement even though President Kennedy’s science adviser, Dr. Jerome Wiesner, remained firmly opposed to LOR.¹²¹

On the day that NASA made the public announcement, Houbolt was giving a paper on the dynamic response of airplanes to atmospheric turbulence

Spaceflight Revolution



On 14 March 1969, four months before the first lunar landing, Life magazine featured the LEM on its cover (right). The magazine proposed a cover featuring John Houbolt (below) but did not use it because of NASA's concern for giving too much credit to any one person for the decision to go to the moon via LOR.

L-66-6301



Enchanted Rendezvous: The Lunar-Orbit Rendezvous Concept

at a meeting of NATO's Advisory Group for Aeronautical Research and Development (AGARD) in Paris.¹²² His division chief, Isadore E. ("Ed") Garrick, was also at the meeting. A talented applied mathematician who had been working at Langley since the 1930s, Garrick had witnessed the evolution of his assistant's ideas on space navigation and rendezvous. He had listened sympathetically to all of Houbolt's stories about the terrible things that had been blocking a fair hearing of LOR.

While at the AGARD meeting in Paris, Garrick saw a little blurb in the overseas edition of the *New York Herald Tribune* about NASA's decision to use LOR. Garrick showed the paper to Houbolt, who had not seen it, shook Houbolt's hand, and said, "Congratulations, John. They've adopted your scheme. I can safely say I'm shaking hands with the man who single-handedly saved the government \$20 billion."¹²³

In the ensuing years, whenever the question of Houbolt's importance for the LOR decision came up for discussion, Garrick said that he was "practically certain that without John Houbolt's persistence it would have taken several more years for LOR to have been adopted." Although "the decisions of many other people were essential to the process" and although "there is no controversy that Houbolt had help from others, . . . the essential prime mover, moving 'heaven and earth' to get the concepts across, remains Houbolt himself."¹²⁴

Postscript

Whether NASA's choice of LOR would have been made in the summer of 1962 or at any later time without the research information, the commitment, and the crusading zeal of Houbolt remains a matter for historical conjecture. His basic contribution, however, and that of his Langley associates who in their more quiet ways also developed and advocated LOR, seem now to be beyond debate. They were the first in NASA to recognize the fundamental advantages of the LOR concept, and for a critical period in the early 1960s, they were also the only ones inside the agency to foster and fight for it. The story of the genesis of LOR underscores the vital role occasionally played by the unpopular opinion. It testifies to the essential importance of the single individual contribution even within the context of a large organization based on teamwork. And it demonstrates the importance of passionate persistence in the face of strong opposition and the pressure for conformity.

Thousands of factors contributed to the ultimate success of the Apollo lunar landing missions, but no single factor was more essential than the concept of LOR. Without NASA's adoption of this stubbornly held minority opinion, the United States might not have reached the moon by the end of the decade as President Kennedy had promised. Without LOR, possibly no one even now—near the beginning of the twenty-first century—would have stepped onto the moon.

Spaceflight Revolution

No less an authority than George Low has expressed this same judgment. "It is my opinion to this day," Low wrote in 1982, "that had the Lunar Orbit Rendezvous Mode not been chosen, Apollo would not have succeeded." All of the other modes "would have been so complex technically, that there would have been major setbacks in the program, and it probably would have failed along the way." Low has also gone on record with his belief, that without "John Houbolt's persistence in calling this method to the attention of NASA's decision makers," and "without Houbolt's letter to Seamans (and the work that backed up that letter)," NASA "might not have chosen the Lunar Orbit Rendezvous Mode." Houbolt's commitment was a key factor in the adoption of LOR and was "a major contribution to the success of Apollo and, therefore, to the Nation."¹²⁵

* * *

At 4:17 p.m. (EDT) on 20 July 1969, John Houbolt, now a senior consultant with the innovative Aeronautical Research Associates of Princeton, New Jersey, sat inconspicuously as one of the invited guests and dignitaries in the viewing room of Mission Control at the Manned Spacecraft Center in Houston. Like so many others around the world at that moment, he listened in wonder to the deliberately spoken yet wildly dramatic words of Apollo 11 astronaut Neil Armstrong: "Houston, Tranquility Base here. The Eagle has landed."

Alternate cheering and shushing followed that precious moment, when Americans landed and stepped onto the moon for the first time. Turning from his seat, NASA's master rocketeer, Wernher von Braun, found Houbolt's eye among all the others, gave him the okay sign, and said to him simply, "John, it worked beautifully."¹²⁶

Skipping “The Next Logical Step”

The reason some of us wanted EOR was not just to go to the moon but to have something afterwards: orbital operations, a space station, a springboard. LOR was a one-shot deal, very limited, very inflexible.

—Jesco von Puttkamer
NASA Marshall engineer

By 1969, it was apparent that there was no logical sequel to the lunar landing, and that the agency would have to redeploy its resources in a radically different direction. Had NASA selected earth-orbit rendezvous instead, the lunar landing could still have been achieved and NASA would have had at least a ten-year start on deploying an orbiting space station, rather than waiting until 1982 to let contracts for its design.

—Hans Mark and Arnold Levine
The Management of Research Institutions

No decision in NASA history had a greater impact on the course of the American space program than the selection of LOR as the mission mode for Apollo. The LOR decision led to a total of six successful lunar landing missions by 1972, thus enabling the United States to win the most important leg of the space race. Whether the United States reaped the many anticipated advantages of winning that race, given the critical national and international problems plaguing the country during the Vietnam era, is another matter altogether. The LOR decision, however, had other ramifications for the U.S. space program; it meant that the country would skip the well-laid plans for a manned space station.

Spaceflight Revolution

Excited NASA researchers had been studying space station concepts seriously for at least four years when NASA chose the LOR mode for Apollo; in truth, many researchers had been planning for a space station from the moment of NASA's beginning as an organization. Although the LOR decision did not stop all space station planning, it decisively changed space station studies by de-emphasizing the immediate importance of earth-orbital capabilities. Moreover, the goal of landing humans on the moon by the end of the decade became all-consuming, and researchers who did space station work in the wake of the mission-mode decision had to compete with Apollo for support. After Apollo, the situation did not improve; space station advocates then had to justify a return to the development of something that the country had once decided it did not need. NASA Marshall engineer Jesco von Puttkamer explains this predicament:

After the close down of Apollo, we began to pay the price. We are trying to fill that gap, which we jumped over, and are having a tough time with a convincing justification to do it. Sometimes I wish we had done EOR. Then we would probably have a space station already. Then we wouldn't have to go back and rejustify something that looks to many people like a step backwards. And in a certain sense it is. We've been to the moon already, history knows, and now all of a sudden we're trying to fill this empty space.¹

This was a major psychological and political obstacle for the champions of any space station concept to overcome. It explains why now, on the eve of the twenty-first century, "the next logical step" in space exploration after orbiting a human has not yet been taken.

In the mid-1970s, the United States did launch an orbital space station, Skylab. The technology for this station was a direct outgrowth of the Apollo Extension System, a spin-off of the LOR-determined Apollo program. Skylab, as successful as it proved to be, was not the versatile and long-lasting station that NASA had planned since the late 1950s. Designed to satisfy the institutional need to do something after Apollo and to keep the NASA team together long enough to finish the lunar landing missions, Skylab was makeshift and temporary. NASA's space station engineers, in fact, deliberately built the station without the thrusters necessary to keep it in orbit for any significant amount of time. By limiting Skylab's "lifetime," they hoped to ensure the construction of a more permanent and sophisticated station—one more in keeping with their original plans. When Skylab came down, they would replace it with the station they had always wanted—that was the idea. In 1979, Skylab did fall to earth and made more news as a burning hunk of metal than it ever did as an operating space laboratory. The public feared that falling pieces of the spacecraft might destroy homes or kill children at play in school yards. Most of the orbital workshop landed in Western Australia, and none of it did any serious damage. Although Skylab came down, by the 1990s, NASA still had not

been able to replace it as hoped. Once skipped over, "the next logical step" proved increasingly difficult to justify.²

"As Inevitable as the Rising Sun"

In imagining how humans would voyage to the moon and the planets, all rocket pioneers envisioned the value of a staging base in earth orbit. The Russian theoretician Konstantin Tsiolkovskii recommended such an outpost in 1911 in his pioneering *Investigation of Universal Space by Means of Reactive Devices*, and the German scientist Hermann Oberth suggested likewise in his 1923 book *Die Rakete zu den Planetenraumen*. Austria's Guido von Pirquet envisioned the use of an earth-orbit station in his series of provocative articles on "Interplanetary Travel Routes" appearing in *Die Rakete (The Rocket)*, which was published by the German Society for Space Travel in 1928 and 1929. Despite these early ideas for a station, rocket enthusiasts did not seriously consider building one until several years after the end of World War II and the appearance of the first practical jet and rocket engines.³

One of the first to offer a station design was the master designer of the V-2 rocket, Wernher von Braun. In 1952, having quickly acclimated himself to the American scene and recognizing the need to make spaceflight a respectable topic for public discussion, von Braun wrote an article for a special issue of the popular American magazine *Colliers*. This issue was devoted to the idea of space exploration. Von Braun called his contribution "Crossing the Last Frontier" and made its focus the imaginative design of a manned space station in permanent earth orbit.⁴

In the article von Braun wrote, "Development of the space station is as inevitable as the rising sun." "Man has already poked his nose into space" with sounding rockets, and "he is not likely to pull it back." "Within the next 10 to 15 years," von Braun predicted, "the earth will have a new companion in the skies." An "artificial moon," an earth-orbiting base "from which a trip to the moon itself will be just a step," will be "carried into space, piece by piece, by rocket ships." From there, the human civilization of deep space would begin.⁵

The space station conceived by von Braun was no crude affair; it was an elaborate and beautiful object, a huge 250-foot-wide wheel. The enormous torus rotated slowly as it orbited the earth to provide artificial or "synthetic gravity" for pressurized living spaces situated about the wheel's center. Writer Arthur C. Clarke and moviemaker Stanley Kubrick would borrow the torus design for their exhilarating (and baffling) 1968 movie epic *2001: A Space Odyssey*. In the film, the space wheel turns majestically to the waltz of Johann Strauss's "The Blue Danube," while a space shuttle vehicle with passengers aboard leisurely approaches the station.

Spaceflight Revolution

The hub of von Braun's wheel served as a stationary zero-gravity module for earth and space observations with an assembly of equipment and instruments useful for a host of scientific and applied industrial experiments. On-board apparatuses would include "powerful telescopes attached to large optical screens, radarscopes, and cameras to keep under constant inspection every ocean, continent, country, and city." At short distances from the station, there would be unmanned stationary platforms for remotely controlled telescopic observation of the heavens. While helping to uncover the secrets of the universe, the space station would also work to disclose the evil ambitions of humankind. With its telescopic and camera eyes, von Braun claimed, the station would make it virtually "impossible for any nation to hide warlike preparations for any length of time." Such would be the novel and unprecedented benefits of a permanent manned base in earth orbit. Von Braun predicted that the station would become a reality in a few decades.⁶

At NACA Langley in the 1950s, the prospects of an orbiting space station did not pass unnoticed. Several researchers speculated about the technology that would be needed someday to develop an operational space station such as the one von Braun had described. Suddenly, in 1958, interest in a space station exploded. While the ink was still drying on the Space Act, preliminary working groups concerned with space station concepts and technology came alive both within NASA and around the aerospace industry. NASA's intercenter Goett Committee was one of these early groups.

At the first meeting of the Goett Committee on 25–26 May 1959, each member addressed the group for 10 to 15 minutes to propose ideas for the next manned spaceflight objective after Project Mercury. Of all the speakers at the meeting, no one sounded more enthusiastic about the potential of an orbiting space station than Langley representative Larry Loftin. In his presentation for what he called Project AMIS, or Advanced Man In Space, Loftin recommended that "NASA undertake research directed toward the following type of system: a permanent space station with a 'transport satellite' capable of rendezvous with the space station." According to Loftin, the space station should possess the following general characteristics: It should be "large enough to accommodate two or more persons for an extended period of time"; it should be "stabilized and oriented in some prescribed manner"; it should be "capable of changing its orientation, and perhaps its orbit, under control of the crew"; and it should be able to attach to the transport satellite for supply and change of personnel. In addition, Loftin argued that the satellite transport or "rendezvous machine" should be able to alter, "through appropriate guidance and control systems, its initial orbit so as to rendezvous with the space station." It should possess a navigation system "which will ensure that that pilot can find and intercept the space station." The transport vehicle should be able to dock with the station "in such a way as to permit transfer of payloads between vehicles," and, importantly, it should be able to return from space and land, under control of the pilot, "at a preselected spot on the earth."⁷

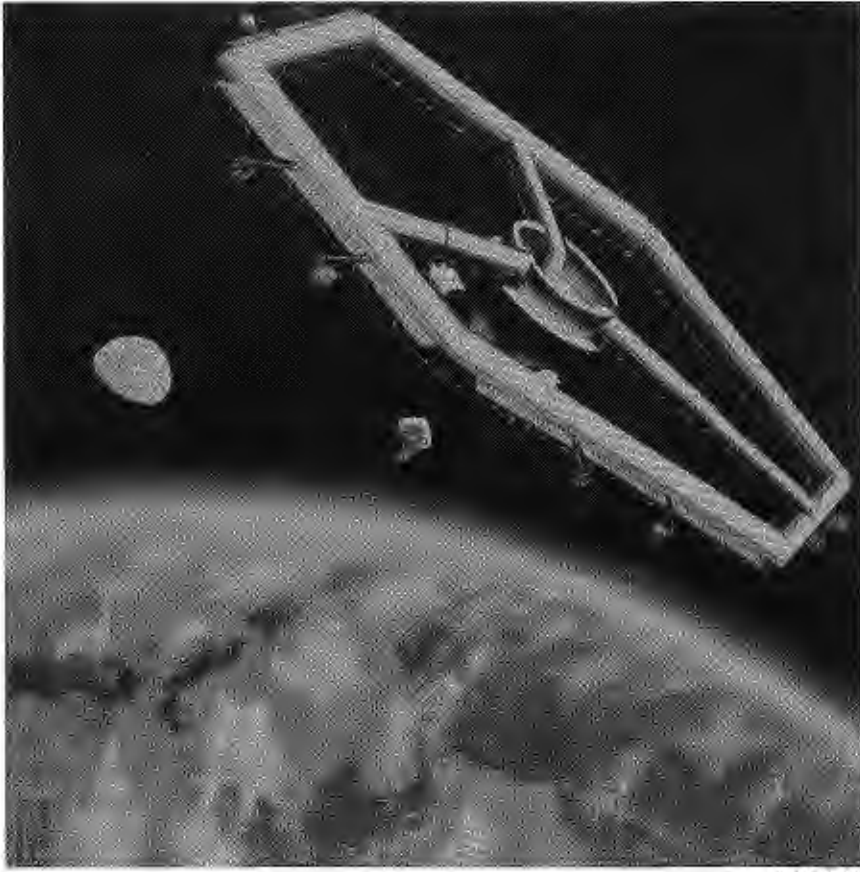

L-62-8400

One of Langley's early concepts for a manned space station: a self-inflating 75-foot-diameter rotating hexagon.

For emergency use, Loftin explained, the station could be outfitted with a "space parachute," some sort of "flexible, kite-like" package that would deploy to make it possible for the station's occupants to survive atmospheric reentry. Otherwise, the space transport would make all trips to and from space. As for what this shuttle-like vehicle might be, Loftin indicated that the air force's X-20 Dyna-Soar manned boost-glider vehicle, "could be modified to perform the desired function." (The X-20 would not be built; Secretary of Defense Robert S. McNamara canceled the multimillion-dollar, six-year-old program in 1963.) As an "initial step" to test the transport concept, Loftin suggested that a "proximity rendezvous of Dyna Soar" with some orbiting satellite might be undertaken.⁸

In his talk Loftin emphasized the many uses of the space station. It could serve as “a medical laboratory for the study of man and his ability to function on long space missions.” In the station, researchers could study “the effects of space environment on materials, equipment, and powerplants.” NASA could use the station to develop new stabilization, orientation, and navigational techniques, as well as to learn how to accomplish rendezvous in space. With telescopes and cameras on board, the station could also serve as an orbiting astronomical observatory and as an “earth survey vehicle” for meteorological, geographical, and military reconnaissance. The minutes of the Goett Committee do not record the immediate reaction to Loftin’s AMIS presentation specifically, but several members of the steering committee did come away from their two-day meeting in Washington with a strong feeling that a manned space station should be the “target project” after Mercury.⁹

At NASA’s First Anniversary Inspection a few months later, Loftin told a large audience at one of the major stops along the tour that NASA’s long-range objectives included “manned exploration of the moon and planets and the provision of manned earth satellites for purposes of terrestrial and astronomical observation,” and perhaps even for military surveillance. But “*the next major step* [author’s emphasis] in the direction of accomplishing these long-range objectives of manned space exploration and use would appear to involve the establishment of a manned orbiting space laboratory capable of supporting two or more men in space for a period of several weeks.” NASA Langley, Loftin told the crowd, was now focusing its research “with a view toward providing the technological background necessary to support the development of a manned orbiting laboratory.”¹⁰

Interestingly, in his original typed comments for the inspection, Loftin had written: “I would like to stress that we at Langley do not intend to develop, build, or contract for the construction of such a vehicle.” The center’s goal, according to Loftin, in keeping with its conservative NACA policy not to design aircraft, was to “seek out and solve the problems which lie in the way of the development of such a vehicle system.” Loftin, however, had crossed through this first line. Perhaps he realized that the times were changing; Langley could “develop, build, or contract” for NASA’s space station.¹¹ This was NASA not the NACA, after all.

The First Space Station Task Force

When Larry Loftin spoke to the Goett Committee, he had already helped Floyd Thompson organize 15 of the center’s brightest researchers into the Manned Space Laboratory Research Group. Thompson had made a surprising choice for the chair of the space station committee in veteran aeronautical engineer Mark R. Nichols, the longtime head of the Full-Scale Research Division. Nichols, a dedicated airplane man, had little interest



L-62-4088



L-62-4065

Two key members of Langley's early space station research were Paul R. Hill (left) and Robert Osborne (right).

in making the transition to space. As mentioned in chapter 4, Thompson made the appointment as an example to the many other airplane buffs at the center. Langley research was still a team effort, and the team was now moving beyond the atmosphere. Aeronautics staff members would be expected to become involved in space projects. No one should expect a deferment—not even the head of a division.¹²

The Manned Space Laboratory Research Group consisted of six subcommittees responsible for the study of various essential aspects of space station design and operations: (1) Design and Uses of the Space Station, led by Paul R. Hill of PARD; (2) Stabilization and Orientation, led by the brilliant and mild-mannered head of the Guidance and Control Branch, W. Hewitt Phillips; (3) Life Support, headed by A. Wythe Sinclair, Jr., of the new Theoretical Mechanics Division; (4) Rendezvous Analysis, led by Houbolt, then the assistant chief of the Dynamic Loads Division; (5) Rendezvous Vehicle, led by Eugene S. Love, who was an extremely talented hypersonics specialist working in the Aero-Physics Division; and (6) Power Plant, led by Nichols himself.* According to handwritten comments by Thompson on the rough organization chart sketched by Loftin, the objective of the space station committee was to “develop technology and make pitch for doing it.” The goal was to demonstrate that “this is possible and this is the way we can do it.” As for how to organize and manage the work of the

* Due to Nichols' ambivalence about the space project, Paul R. Hill actually took over much of the leadership role for the group.

Spaceflight Revolution

committee, Thompson said only to “organize like WS 110,” that is, similar to the support of the development of Weapons System 110, the air force’s experimental B-70 strategic bomber. The organization would be informal so that it could cut across formal divisional lines, but its work would receive the highest priority in the shops.¹³

Thompson made one other revealing note at the bottom of the committee’s organization chart: “Plan whole organization of getting man to moon.” This footnote implies that in Thompson’s mind the clear and accepted objective of NASA’s manned space effort following Project Mercury was to send an astronaut to the moon and back. The way to achieve that objective was, as all the visionaries of space exploration had articulated, by moving out from an orbiting relay station. Langley’s associate director was asking his in-house committee to study the entire enterprise involved not only in building and operating a space station but also in using it as a launchpad for the eventual manned lunar landing mission.¹⁴

Not everyone in NASA thought that the space station should be the target project. Dr. Adolf Busemann, the German pioneer of the swept wing who came to Langley in 1947, argued that the space environment would offer experimenters no vital scientific or technological knowledge that researchers with some ingenuity could not acquire on earth. But with the exception of Busemann and the small group of lunar landing advocates mostly clustered around Clint Brown and the Theoretical Mechanics Division, nearly everyone else at Langley in the summer of 1959, including senior management, threw their weight behind the space station. Members of Nichols’ group immersed themselves in a centerwide effort to define and answer a host of major questions related to placing and operating a manned laboratory in earth orbit. Inquiries and suggestions were pouring into Langley from the aerospace industry, notably from the Goodyear Aircraft Corporation, Chance Vought Astronautics, and the Martin Company, whose representatives had heard what NASA Langley was up to and wanted to participate in the development of the manned station.¹⁵

By the fall of 1959, the work of the Nichols committee had progressed to the point where Loftin could make a simple three-point statement of purpose. Langley would (1) “study the psychological and physiological reactions of man in a space environment over extended periods of time,” thereby determining “the capabilities and limitations of man in performing long space missions”; (2) “provide a means for studying materials, structures, control and orientation systems, auxiliary powerplants, etc., in a true space environment”; and (3) “study means of communication, orbit control, rendezvous,” as well as techniques for earth and astronomical observations.¹⁶ In summary, Loftin told the committee that Langley was primed and ready to take on the role of the lead center in all NASA’s space station work—quite an ambitious undertaking for the former NACA aeronautics laboratory.

From the Inflatable Torus to the Rotating Hexagon

If Langley researchers favored any particular kind of space station as they set out to examine the feasibility of various configurations in 1960, their preference was definitely a self-deploying inflatable. The Langley space station office had eliminated one-by-one the concepts for noninflatable configurations, some of which came from industry. Notions for a simple orbiting "can," or cylinder, and for a cylinder attached to a terminal stage of a booster were rejected as dynamically unstable; they had a tendency to roll at the slightest disturbance. A version of Lockheed's sophisticated elongated modular concept was turned down because it was too futuristic and required the launch of several boosters to place all the components into earth orbit. Proposals for hub-and-spoke designs, big orbiting Ferris wheels in space, were turned down because of the Coriolis effects. Disturbances of the inner ear, such as nausea, vertigo, and dizziness, would debilitate crew members moving radially in any system that was rotating too rapidly.

Langley's space station team had sound technical reasons for doubting the feasibility of these proposals. However, the team possessed a strong institutional bias for an inflatable station. After all, the inflatable was developed at Langley. The concept also made good engineering sense. Hundreds of pounds of propellant were required to put one pound of payload into orbit. Any plan that involved lightening the payload meant simplifying rocket requirements. Because of their experience with the Echo balloon, Langley engineers also knew firsthand that a folded station packed snugly inside a rocket would be protected during the rough ride through the atmosphere.

The first idea for an inflatable station was the Erectable Torus Manned Space Laboratory. A Langley space station team led by Paul Hill and Emanuel "Manny" Schnitzer developed the concept with the help of the Goodyear Aircraft Corporation. Their idea called for a flat inflatable ring or torus 24 feet in diameter, or about one-quarter the size of the *Echo 1* sphere.¹⁷

The inflatable torus had several major selling points. It was "unitized," meaning that all its elements were part of a single structure that could be carried to orbit by the launch of one booster, just as was the case with the Echo balloon. NASA would simply fold the station into a compact payload for an automatic deployment once the payload had reached altitude. The inner volume of the torus could be given a gravity capability of 0 to 1 G. The station could be designed for both natural and artificial stability, for rendezvous-dock-abort capability, and for variable-demand power supply. The torus could also have regenerative life-support systems for a six-person crew. To provide their space station with electric power, Hill and Schnitzer pursued the possibility of using a solar turboelectric system, which used an innovative umbrella-like solar collector then under development by TRW as part of the NASA-supported Sunflower Auxiliary Power Plant Project.



L-63-3879

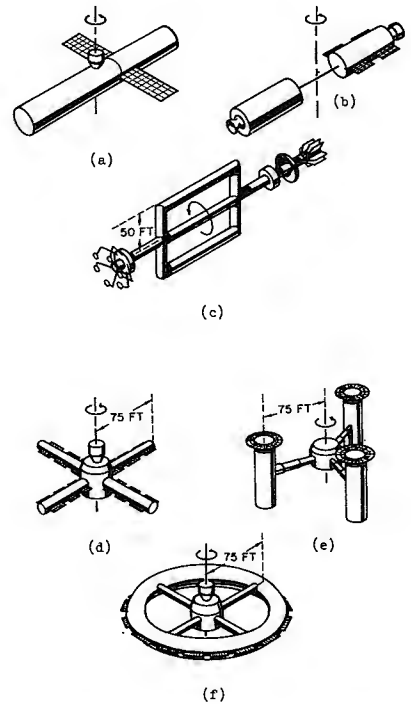

Langley researcher Rene Berglund (left) used this figure (right) in 1962 to illustrate some of the earliest space station configurations investigated at the center: (a) a large cylinder, (b) a smaller cylinder attached to a terminal-stage booster, (c) a boom with multiple docking ports powered by a nuclear power plant at one end, (d) a spoke configuration, (e) a modified spoke configuration with vertical rather than horizontal modules, and (f) a wheel or torus.

By April 1960, Schnitzer was so enthusiastic about the inflatable torus that he made a formal presentation on the design to a national meeting of the American Rocket Society. A revised and updated version of his talk appeared as the feature article in the January 1961 issue of *Astronautics Magazine*. (In late 1962, Schnitzer moved to the Office of Manned Space Flight at NASA headquarters, where he would remain active in space station R&D and promote Langley's work in the field.)¹⁸

In the months following Schnitzer's presentation, Langley built and tested various models of the Erectable Torus Manned Space Laboratory, including a full-scale research model constructed by Goodyear. But researchers began to suspect that the design was lacking in certain key respects. The principal concern was the same one that had plagued the promoters of Echo: the danger of a meteorite puncturing the structure. Goodyear built the research

Skipping “The Next Logical Step”

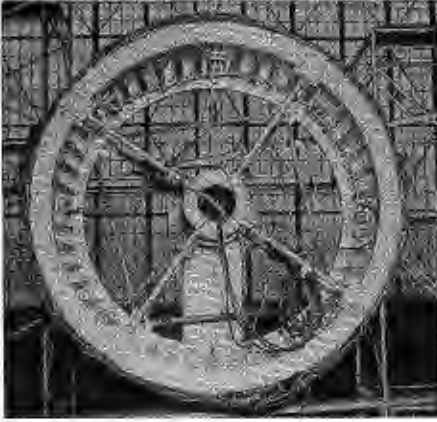

L-61-8027



L-61-8029

Testing indicated that the inflatable torus could be packaged around the hub so that it occupied only 2 percent of its inflated volume.



L-61-8693

Looking like a huge pneumatic tire sitting on a giant car jack, Langley’s full-size test model of its 24-foot toroidal space station receives a visit from NASA Administrator James Webb in December 1961. Escorting Webb are Floyd Thompson (far left) and T. Melvin Butler, Langley’s assistant director for administration.

Spaceflight Revolution



L-62-312

Langley engineers check out the interior of the inflatable 24-foot space station in January 1962.

model out of a lightweight three-ply nylon cord held together firmly by a sticky rubber-like material known as butyl elastomer. Such a large rubberized surface would certainly be vulnerable during a meteoroid shower. This concern proved much harder to dismiss for a manned station than for the unpiloted satellite. In addition, while the condition of being “dead soft” was seen as an advantage for the Echo balloon, it was a disadvantage for a busy manned space station. Some engineers worried that if the flexible material was not strong enough, crew members moving around vigorously in the space station might somehow propel themselves so forcefully from one side of the station to the other that they would break through a wall and go shooting into outer space.

A more serious engineering concern arose that was related to the dynamics of the toroidal structure. When arriving crew members moved equipment from the central hub to a working area at the outside periphery of the ring, or when a ferry vehicle simply impacted with the station’s docking port, Langley researchers believed that the station might become slightly unstable, thus upsetting its precisely established orbit. Less strenuous activities might also disturb the fragile dynamics of the torus. Knowing that the human occupants of the station would have no weight but would still have mass, the Langley space station group conducted analytical studies using

Skipping "The Next Logical Step"

analog computers to calculate the effect of astronauts moving about in the station. The results showed that the mass distribution would be changed when crew members just walked from one part of the vehicle to another. This change produced a slight oscillation, or what the researchers called a "wobble," of the entire station.

To discover whether they could alleviate this wobble, the Langley space station group decided to build a 10-foot-diameter elastically scaled model of the torus. This model did not become operational until the summer of 1961, however, and by that time NASA had realized that it must either develop a more rigid inflatable or abandon the idea of an inflatable altogether.¹⁹

While still in pursuit of the best possible inflatable torus, the NASA Langley space station group did explore other ideas. Most notably, in the summer of 1961 it entered into a six-month contract with North American Aviation for a detailed feasibility study of an advanced space station concept.* Developed by Langley engineer Rene A. Berglund, the design called for a large modular manned space station, which although essentially rigid in structure, could still be automatically erected in space. In essence, Berglund's idea was to put together a series of six rigid modules that were connected by inflatable spokes or passageways to a central nonrotating hub. The 75-foot-diameter structure (initially planners thought it might be as large as 100 feet) would be assembled entirely on the ground, packaged into a small launch configuration, and boosted into space atop a Saturn rocket. One of Berglund's prerequisites for the design was that it provide protection against micrometeorites. To accomplish this, he gave the rigid sections of the rotating hexagon air-lock doors that could be sealed when any threat arose to the integrity of the interconnecting inflatable sections.²⁰

This sophisticated modular assembly was to rotate slowly in space, thus making it possible for its occupants to enjoy the benefits of artificial gravity, which virtually all space station designers at the time believed was absolutely necessary for any long-term stay in space. In fact, the diameter of 75 feet was selected because it provided the minimal rotational radius needed to generate at low rotational velocities the 1 G desired for the station's living areas. Rotation was the only mechanism known at the time for artificially creating gravity conditions. The only part of the structure that would not rotate was the central hub; suspended by bearings, the hub would turn mechanically in the opposite direction of the hexagon at just the right rate to cancel all the effects of the rotation. Located in this nonrotating center of the space station would be a laboratory for various experiments, including comparative studies of the effects of zero and artificial gravity. The nonrotating hub would also contain the dock for the ferry vehicle. Preliminary experience with Langley's earliest rendezvous and docking simulators indicated that a trained pilot could execute a docking

* North American had been studying the logistics of a permanent satellite base and a global surveillance system for the air force, and the physics of meteoroid impact for NASA.

Spaceflight Revolution

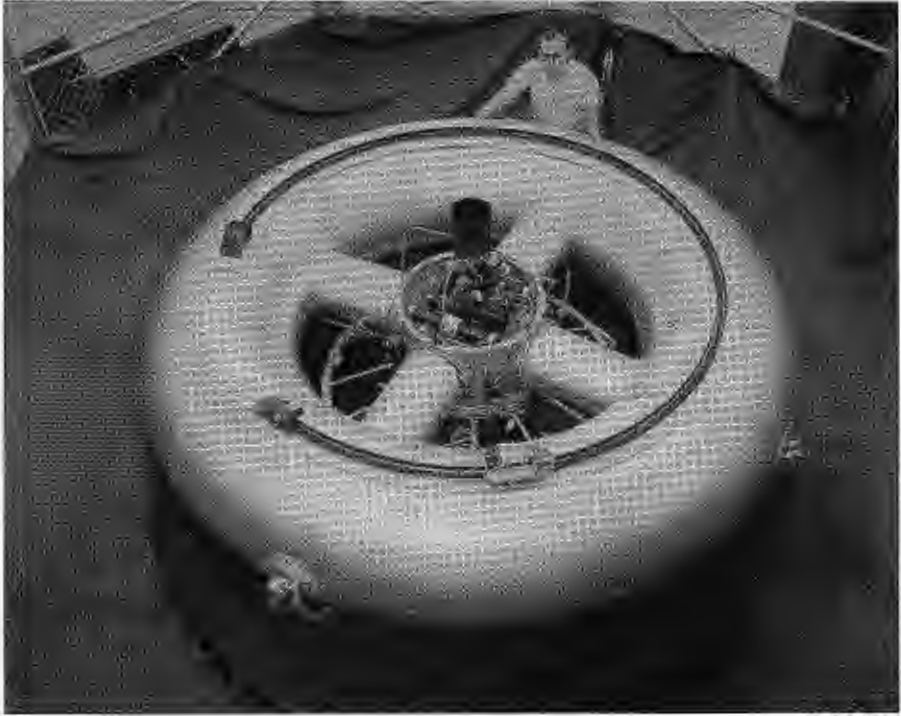

L-62-3819

With a 10-foot-diameter scale model (above), Langley researchers studied the attitude errors, wobbling motions, and other dynamic characteristics of a space station spinning in space. The effects of crew motion and cargo transfer within the station were simulated by an electrically driven mass moving around a track on the torus. To the right, a Langley engineer takes a walk in simulated zero gravity around a mock-up of a full-scale, 24-foot-diameter space station.



L-64-10,099

maneuver with surprising ease as long as the station docking hub was fixed. If the hub rotated along with a rotating station, the maneuvering operations would have to be much more complicated.

As engineers from North American and Langley probed more deeply into the possibilities of a rotating hexagon, they became increasingly confident that they were on the right track. The condition that the station be self-deploying or self-erecting (implying some means of mechanical erection or a combination of mechanical erection with inflation) was not negotiable, given the economic and technological benefits of being able to deliver the space station to its orbit via a single booster. Early on, the space station group talked with their fellow engineers in the Scout Project Office at Langley about using a Scout booster to launch the station, but Scout did not appear to be powerful enough to carry all 171,000 tons of the rotating hexagon to orbit altitude. The group also looked into using a Centaur, a liquid-fuel booster for which NASA had taken over the responsibility from the DOD. The Centaur promised higher thrust and bigger payloads for lunar and planetary missions; however, Langley learned in early 1961 that the Centaur was "out of the question" because "nothing in the [high priority] NASA manned space programs calls for it." Furthermore, the Centaur was not yet "man-rated," that is, approved for flights with astronauts aboard, and a man rating was "neither expected nor anticipated." Centaur would prove to be a troublesome launch vehicle even for its specified unmanned missions, and the rocket never would be authorized to fly humans.²¹

Soon space station advocates turned to von Braun's Saturn. With its 210,000-pound payload capacity, an advanced Saturn could easily lift the 171,000-pound hexagon into orbit. A team of Langley researchers led by Berglund did what they could to mate their space station to the top stage of a Saturn. Working with a dynamic scale model, they refined the system of mechanical hinges that enabled the six interconnected modules of the hexagon to fold into one compact mass. As a bonus, the hinges also eliminated the need for fabric connections between modules, which were more vulnerable to damage. Tests demonstrated that the arrangement could be carried aloft in one piece with the three retractable spokes stowed safely inside the cavity of the assimilated module cluster. Once orbit was achieved, a series of screw-jack actuators located at the joints between the modules would kick in to deploy the folded structure. The Langley researchers also made sure that the nonrotating central hub of their hexagon would have a port that could accommodate ferry vehicles. Such vehicles were then being proposed for the Apollo circumlunar mission and, later, for a lunar landing via EOR.

The estimated cost for the entire space station project, for either the erectable torus or the rotating hexagon, was \$100 million, a tidy sum upon which Langley and NASA headquarters agreed. This figure amounted to the lowest cost proposal for a space station submitted to the air force at its space station conference in early 1961. But, as George Low pointed out

HEXAGONAL CONFIGURATION

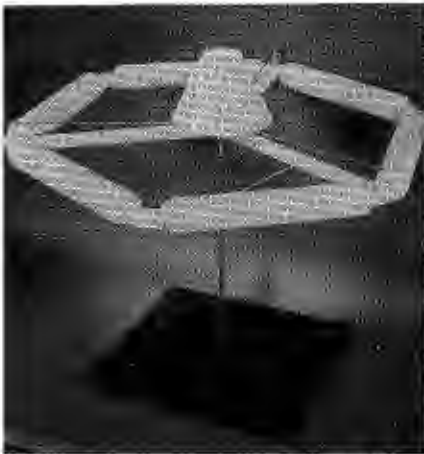
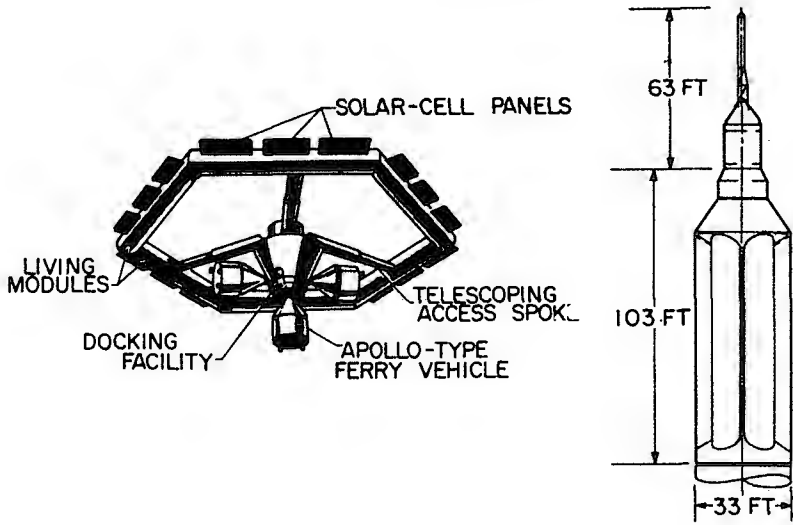

L-62-8730

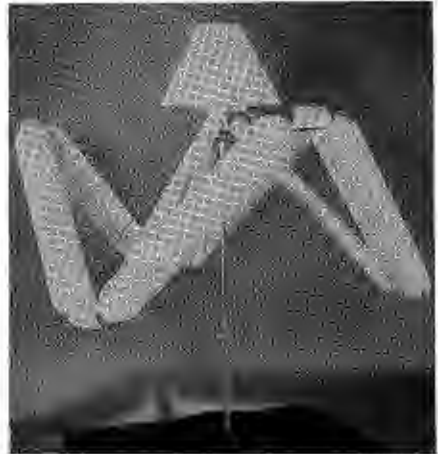

L-62-8732

North American selected this space station design in 1962 for final systems analysis (diagram shown at top, models at bottom, left and right). Incorporating all the advantages of a wheel configuration, it had rigid cylindrical modules arranged in a hexagonal shape with three rigid telescoping spokes. This configuration eliminated the need for exposed flexible fabric.

Skipping "The Next Logical Step"

at a space station meeting held at Langley on 18 April 1961, NASA did not have the money for a space station follow-on to Project Mercury; what funds NASA expected were "only enough to finish Mercury and \$29 million for Apollo."²²

For five more weeks, until President Kennedy's speech on 25 May, Apollo entailed only a circumlunar mission, with the possibility of building a space station as a by-product of the earth-orbital phase; however, as George Low observed, NASA had not guaranteed that such a phase would be part of Apollo. Low warned the assembled space station advocates that the chances were high that Apollo would not require a space station with artificial gravity. If that were the case, NASA would have neither the mandate nor the money to build a space station of any kind for some time to come.

Such uncertainty put Langley in a difficult but not unfamiliar situation. Some sort of space station was possible for the Apollo era, and as long as that possibility existed, the basic technology needed for a station had to be ready, perhaps at short notice. To assure that Langley would be technologically prepared, exploratory research had to be ongoing.

Larry Loftin made this point clear on 19 May 1961, six days before President Kennedy's lunar landing speech, in his testimony to the U.S. House Committee on Science and Astronautics, chaired by Overton Brooks (Democrat from Louisiana). "We have not been developing a manned vehicle," Loftin reassured the congressmen and their staffs. "We have been studying what we would consider to be salient or pertinent problems which would have to be solved" if the country decided that a station was needed. Loftin described in some detail Langley's manned space station work. "In order to try to fix what the problem areas were," he explained, "it was necessary to arrive at some sort of a concept of what the vehicle might look like." He then passed around a series of pictures showing Langley's concepts for both the inflatable torus and the rotating hexagon, expressing no preference for either design.* After reviewing the general characteristics of both designs, Loftin summarized Langley's assessment of the status of the space station:

So far as we know, so far as we have gone at the present time, we don't see that there are required any fundamental scientific breakthroughs . . . in order to design one of these things. However, we have not undertaken at the Langley Research Center a detailed engineering design study. If such a study were undertaken, you might run into some problems that we haven't been smart enough to think about that are fundamental. I don't know if you would, but you could.

Moreover, Loftin concluded his testimony with a caution, "In such a careful engineering design, this is a long-term proposition. We are not really sure

* Two representatives of the Goodyear Aircraft Corporation, the primary contractor involved in Langley's study of the inflatable torus, were testifying the same day before the congressional committee.

Spaceflight Revolution

when you got all done whether you would have something you really want or not.”²³

Whether the politicians understood Loftin’s essential point is uncertain, for they had a difficult time even fathoming what a manned space station was all about and how someday it might be used. Chairman Overton Brooks, for example, asked, “You are just going to allow that [thing] to float around in space?” When asked by Minnesota congressman Joseph E. Karth what the “primary function of this so-called space station” would be, Loftin answered, “It could have many functions. We are not really proposing a space station. What we are doing here is saying if you want one, we would like to look into the problems of how you might make it.” Encouraged to say what those functions were, Loftin explained how the experience of having humans in an orbiting space station would be helpful and perhaps even necessary in preparing for long-distance space flights, perhaps even for the two-week trip from the earth to the moon and back that the United States was now planning. Certainly, if the United States was to attempt any flights to places more distant than the moon, Loftin explained, “it would be desirable to have a space station in orbit where we could put men, materials, different kinds of mechanisms. We could put them up there for weeks at a time and see if there are any undesirable effects that we have not foreseen. If these effects crop up, then you bring the man back.” An astronaut already on course to a distant planet was not so easily retrieved.²⁴

Betwixt and Between

Six days after Loftin’s appearance before the congressional committee, President Kennedy stunned NASA with his lunar landing speech. Apollo was no longer a manned circumlunar mission; it was now the project for landing a man on the moon by 1969. In one extraordinary political moment, step three of the space program had become step one. For 14 months following Kennedy’s speech, NASA debated the advantages and disadvantages of various mission modes. For at least the first half of this period, many in NASA were quite sure that the country would be going to the moon via EOR. In this mode, the lunar spacecraft would actually be assembled from components put into orbit by two or more Saturn launch vehicles. This EOR plan would therefore involve the development of certain orbital capabilities and hardware that might easily translate into the country’s first space station.

With this possibility in mind, Langley’s space station team worked through the remainder of 1961 and into 1962 to identify and explore the essential problems facing the design and operation of a space station. The thrust of the center’s research during this period of political and institutional limbo for the space station was divided among three major areas: (1) dynamics and control, or how to control a rotating structure in

orbit; (2) on-board power, or how to provide electrical power as well as store and use energy in the space station; and (3) life support, or how to ensure that the occupants of the station could best remain healthy and vigorous during (and after) long sojourns in space.

From the start, almost all space station designers presumed the need for artificial gravity. From this presumption came the notion of a rotating structure, be it a rotating cylinder, torus, or hexagon, or of a centrifuge mechanism within a nonrotating structure that could provide a force that substituted for the lack of gravity. Whether it was absolutely necessary to substitute centrifugal force for the effects of gravity, no one really knew. Perhaps a human in space would need 1 G; perhaps as little as 0.25 G would do. One thing the space station researchers did know with some certainty was that they needed to be careful about this matter of gravitational effects. If the rotational radius was too small, or the structure rotated at too high an rpm, the astronauts inside would suddenly become ill.

The rotation had to be controlled precisely, whatever the station's configuration. Thus, one set of problems that Langley researchers attempted to solve concerned a spinning space station's inherent vulnerability to disturbances in dynamic stability; this included compensating for the wobble motions that might occur when crew members moved about inside the station or when ferry vehicles pushed up against the outside structure during docking.

The Langley space station group found a solution for attitude control using a system of four pulse jets.* These small pulse jets could be mounted at 90-degree intervals around the outside rim of the station to reorient the station when necessary. Then, to dampen the wobbles caused by crew movements and other disturbances in mass distribution, Langley found that a spinning flywheel could be rotated to produce the necessary countervailing torques; the same flywheel could produce the torque required to keep the station rotating around its predetermined axis. If the flywheel failed to steady the wobbles, the pulse jets could be fired as a backup. In late 1961 and early 1962, Langley researchers subjected full-scale models of both the rotating hexagon and the inflatable torus (the torus was then still being considered) to systematic tests involving these experimental control mechanisms.²⁵

Langley researchers found little reason to disagree about what was needed for the dynamic control of the space station; however, bitter arguments arose over the power source for the station. Two main energy sources were considered: solar and nuclear. (A third possibility, involving the use of chemical energy from a regenerative fuel cell, was considered briefly but was summarily dismissed as "futuristic" and "unfeasible.") To many at Langley,

* A pulse jet is a simple jet engine, which does not involve a compressor, in which combustion takes place intermittently and produces thrust. In this case, 10 pounds of thrust per pulse jet is produced by a series of explosions.

Spaceflight Revolution

the obvious choice was solar. The sun's energy was abundant and available. If solar power was used, the space station would not have to carry the weight of its own fuel into orbit; photovoltaic or solar cells (which existed in 1960 but not in a very advanced form) would simply convert the sunlight into the electrical energy needed to run the space station.

Outspoken critics, however, argued that the technology did not yet exist for a solar-powered system that could sustain a spacecraft over long missions. With the rotation necessary for artificial gravity, situating and realigning the solar panels so that they would always be facing the sun became problematic. Depending on the station's configuration, some solar panels would be shaded from the sun most of the time. Solar panels, especially large ones, would also have an undesirable orbital drag effect.

Some argued that the better choice was nuclear power. The problems of shielding living areas from the reactor's radiation and radioactive waste would have to be solved, of course, because humans would be on board, but once these problems were resolved, a small nuclear reactor could safely supply enough power (10 to 50 kilowatts) to sustain the operation of a station for a year or more. Yet engineers were not able to overcome the major logistical and safety problems of the proposed reactor systems. Particularly bothersome was the problem of replacing an operational reactor should it fail. Even the shielding problem proved more difficult to handle than imagined. In later space station designs, engineers tried to bypass the shielding problem by employing a large shadow shield and a long boom to separate the reactor from the habitation areas, but the boom required such a major reconfiguration of the proposed space station structure that the idea had to be abandoned.

Some researchers rejected both solar and conventional nuclear systems and advocated a radioisotope system. In this arrangement a radioactive element such as uranium 238 or polonium 210 would emit energy over a long period and at a specific and known rate. This power system was based on the so-called Brayton cycle (also called the "Joule cycle"), which was a well-known thermodynamic cycle named after American engineer and inventor George B. Brayton (b. 1873). The Brayton cycle consisted of an isentropic compression of a working substance, in this case a radioactive isotope, the addition of heat at a constant pressure, an isentropic expansion to an ambient pressure, and, finally, the production of an exhaust. Such a system required minimum shielding and did not require booms or large panels. The availability of high-quality waste heat could also be used in thermal control and in the life-support system, thereby reducing the overall power system requirements. On the other hand, the isotope Brayton cycle power system did require internal rotating machinery that still needed considerable development. It would also require an increased radiator area as well as doors on the skirt of the radiator that could open to allow the isotope to radiate directly into space when the power system was not functioning. Even

Skipping "The Next Logical Step"

nuclear enthusiasts had to admit that this machinery and auxiliary hardware would probably not be available for at least 10 years.²⁶

In trying to choose between the various options for the on-board power supply, the "power plant" subcommittee of Langley's Manned Space Laboratory Research Group reviewed several pertinent R&D programs involving solar and nuclear power plants then under development by NASA, the air force, and the Atomic Energy Commission; however, after this review, the subcommittee was still undecided about the best power source. In a feasibility study of the rotating hexagon conducted by North American Aviation, solar power was the favored source. According to the company's proposed design, a group of solar cells and associated electrical batteries could be mounted successfully on the six main modules as well as on the hub of the space station. When Langley's power plant subcommittee evaluated the solar modular system, they judged it to be the most feasible in the near term because the system did not require the development of much technology but was still adequate to meet the projected station's electric power needs.²⁷

This evaluation only temporarily resolved the controversy about which type of power plant to incorporate in the study configurations. Several Langley researchers who favored a small on-board nuclear reactor (and who were to be closely associated with subsequent space station planning at the center) were never convinced by the arguments in favor of solar power. This small group, whenever the opportunity arose, would argue that energy from a naturally decaying radioactive isotope ultimately offered the best means of powering a space station. However, this group never could overcome the fear that many researchers had about a nuclear accident, no matter how remote that possibility might be. If the small canister carrying the radioactive isotope ever happened to crash into the earth, because of a launch failure, for instance, the results of the contamination could be catastrophic.²⁸

The issue of the power supply was critical to the design of the space station because of the "human factor." As everyone involved with space station research understood, the greatest single draw on the power supply would be the systems necessary to keep the crew inside the space station alive and in good physical and emotional condition. In fact, the human factor was central to *all* the elements of space station design: the gravity and energy requirements, the sources of wobble, the number and sizes of modules and ferry vehicles, the number and length of missions, and the types of internal furnishings and accommodations. Human occupancy established the central parameters for the entire research and design process. The job of the Langley space station group was not to build the actual hardware that would sustain human life in space; rather, it was to "evaluate and originate basic concepts of life support systems." This evaluation was to include exploration of a range of prototypes to generate the technological knowledge that could form the basis for an "optimum-system concept."²⁹

The essential requirements for a human life-support system aboard a long-duration spacecraft in earth orbit were not hard to determine. The

Spaceflight Revolution

system had to be lightweight and very dependable, and it had to consume as little energy as possible. It would have to provide oxygen for breathing; food for eating; accommodations for sleeping, exercising, washing, and taking care of other bodily functions; and it would have to somehow eliminate or recycle human and other waste products.

Either through in-house research or by contracting out to industry, all of these basic matters of life support and many others were thoroughly studied by the Langley space station group in 1961 and 1962. Several contractors became specialists in the development of experimental mechanisms for collecting, treating, reclaiming, and disposing of solid and liquid wastes. For its rotating hexagon, North American invented a method for carbon dioxide removal involving a regenerative molecular sieve. Small silica gel beds removed water vapor from the air and passed it into the molecular sieve, which then either vented the absorbed water and exhaled carbon dioxide to the outside or shunted it to an oxygen regeneration system.³⁰

None of the solutions proposed during this period, however, were completely satisfactory. What Langley researchers wanted for their optimum space station was a totally closed water-oxygen system—one that did not have to be resupplied from the ground. In the early years, many problems associated with such a closed life-support system appeared relatively easy to solve, but they proved troublesome. This was especially true for the water recovery and recycling system in which the astronauts' urine was to be converted into drinking water. In the early years, researchers tried such things as simply blowing air over the liquid waste, controlling the odor by using a bactericide, and evaporating the water on a cold plate. Unfortunately, a huge amount of power was needed to do that, and it was more power than any space station could afford. The astronauts' natural aversion to drinking water made in this manner also posed a problem. Psychological studies, however, showed that thirst would quickly overcome disgust. Today, after more than 30 years of space station research, effective technology for such a closed water recycling system still does not exist.³¹

Langley researchers went to great lengths to discover the unknowns of life in a spinning spacecraft. One fun-loving group made a trip to the amusement park at Buckroe Beach near the mouth of the Chesapeake Bay to ride the carousel. They took a bunch of tennis balls with them to throw back and forth while sitting atop their colorfully painted wooden ponies. The man attending the carousel soon threw the researchers off the ride because they were making children sick. But even this information was instructive about Coriolis effects on astronaut equilibrium and hand-eye coordination.³²

Of course, the Langley researchers also carried out many less frivolous and more systematic simulations of human performance in space. To investigate how the effects of rotation might conceivably hamper astronaut performance, the space station group put several volunteers, including a few Langley test pilots, into simulators that mimicked the rotations of a space station. Some of these volunteers managed to stay in the simulator for several hours before

asking (or in some cases, demanding) to be let out. Data from other man-in-space simulations, some of them done to garner real-time data about how crews would do during 7-day and 14-day missions to the moon, also shed light on what to expect inside a space station.³³

Overall, the early findings about the ability of humans to adapt to life in space were quite reassuring. Simple adjustments in sleep and work schedules alleviated astronaut fatigue and boredom. An on-board exercise program would forestall marked deterioration in muscle tone and other physiological functions at zero gravity. Most importantly, a weeklong confinement of a three-person crew within the close quarters of a module had no detrimental effect on performance, nor did it trigger psychological stress. In short, the Langley simulations of 1961 and 1962 reinforced a growing body of evidence that humans could indeed live successfully in space, and could remain physically and mentally healthy and able to carry out complex tasks for extended periods.

Other critical matters, however, still demanded study. To see if a comfortable "shirt-sleeve" working environment could be provided for astronauts inside the space station, Langley researchers worked with a thermal vacuum chamber in which they put small, scale models of their inflatable torus and rotating hexagon designs. Built for Langley by Grumman, this chamber employed an arc that served as the "sun" and smaller electric heaters that served as analogues for heat-producing humans. After several weeks of tests with this thermal chamber, researchers found that the North American hexagon design, because of its insulated, protective walls, was superior to the torus.³⁴

Protecting the occupants of the space station from the heat of the sun was one thing; protecting them from meteorite showers was still another. Into the early 1960s, according to a Langley study, NASA still faced "severe uncertainties regarding the basic structure of manned space stations." How should the walls of such a structure be built, and out of what materials? They had to be light because of launch-weight considerations and built of a material that would help in the control of internal temperatures. The walls also had to provide dependable and long-term protection from major meteoroid penetrations; some small chinks and dents in the sides of a space station might cause no trouble, but big hits, especially in the case of an inflatable torus, could prove disastrous. Thus, structures experts at both Langley and Ames looked for the type of wall structure that offered the greatest protection for the least weight. They turned to a sandwiched structure with an inner and an outer wall. Developed by North American for the rotating hexagon, the outer wall was a "meteoroid bumper" made of aluminum, backed by a polyurethane plastic filler that overlay a bonded aluminum honeycomb sandwich. Such a wall seemed to meet the design criteria, but no one could be sure because the actual velocities of meteoroid impacts were impossible to simulate in any ground facility. The only thing to do was to make further studies. For the inner wall, Langley's space

Spaceflight Revolution

station office looked into the efficacy of nylon-neoprene, dacron-silicone, saran, Mylar (E. I. du Pont de Nemours & Co., Inc.), polypropylene, Teflon (E. I. du Pont de Nemours & Co., Inc.), and other flexible and heat-absorbing materials. These materials could not be toxic or leak gases (especially oxygen), and they had to be able to withstand a hard vacuum, electromagnetic and particle radiation, and temperatures ranging from -50° to 150°F.³⁵

At a symposium held at Langley in late July 1962, the Langley staff assembled in the large auditorium in the center's main activities building to present summary progress reports on their exploratory space station research. By the time of this symposium, Langley's space station researchers had arrived at four key conclusions:

(1) The rotating hexagon was superior to the inflatable torus; a 15-foot scale model of the North American design had been undergoing tests at Langley for several months, whereas studies of the torus had virtually ceased.³⁶

(2) Although the hexagon was preferable to the torus, the Langley researchers knew that they had not yet discovered the optimum design and were committed to carrying out "the conceptual design of several space stations in order to uncover the problem areas in such vehicles."³⁷

(3) A flight program, something akin to a Project Shotput, was needed to extend space station research. The space environment was difficult to impossible to simulate in a ground facility, thus making tests of station materials impossible as well. As early as May 1961, members of the Langley space station office had proposed using a Scout rocket to test the deployment of a 10-foot version of the inflatable torus at an orbit of 220 miles; however, the idea for the test had gone nowhere.³⁸

(4) Whatever R&D was to be done on space stations in the future, the researchers wanted their work to be guided by the broad objectives of learning how to live in space, of making the station a place for scientific research, and of finding ways to make the station "a suitable facility for learning some of the fundamental operations necessary for launching space missions from orbit." Moreover, they wanted their space station efforts to be better integrated with the overall NASA effort.³⁹

Langley researchers regarded a manned space station as more than a jumping-off point for Apollo or for some other specific mission. They thought of it as a versatile laboratory in space, a Langley research operation that happened to be located hundreds of miles above the earth rather than in Tidewater Virginia. Just as Langley had always explored the basic problems of flight with a view to their practical solution, the ultimate use of a space station was "for continuing to advance the technology of space flight."⁴⁰ The objective was long-term, not just immediate.

How the space station would fare without any direct application to the Apollo lunar landing program was a question that loomed over the researchers at the symposium. With an expensive Apollo program in

progress and LOR the chosen strategy, Washington's support for an earth-orbiting space station might quickly plummet, no matter what Langley scientists and engineers had to say about the potential benefits of space station operations. If the space station was to be built in the near future, Langley would have to quickly reconcile the objectives of the station with those of the Apollo mission.

Manned Orbital Research Laboratory

In the months following the in-house symposium, Langley management initiated a revised program of space station studies that would better dovetail with the Apollo lunar landing program. In late 1962, this determination brought forth a more focused space station effort—one that proved to be qualitatively quite different from the broader conceptual studies that had given birth to the inflatable torus and the rotating hexagon. As a result of this concentrated effort, Langley researchers in early 1963 conceived a smaller and more economical space station that would complement and make maximum use of the technological systems being developed for Apollo. They called it the Manned Orbiting Research Laboratory, or MORL, for short.

The original MORL concept evolved within Langley's space station group. The idea was for a "minimum size laboratory to conduct a national experimental program of biomedical, scientific, and engineering experiments," with the laboratory to be specifically designed for launch in one piece atop a Saturn I or IB. The goal of the MORL program was to have one crew member stay in space for one year, with three other crew members on board for shorter periods on a rotating schedule. Langley wanted to achieve this goal in 1965 or 1966, a few years before the anticipated first manned Apollo flight, and accomplish it in unison with Project Gemini, the NASA program that bridged Mercury and Apollo, whose basic purpose was to resolve the problems of rendezvous and docking and of long-duration manned spaceflights necessary for a successful lunar landing via LOR. The MORL would be launched unmanned by a Saturn booster into a circular orbit from Cape Canaveral, and after a short checkout period, two crew members in a Titan-mounted Gemini spacecraft (then under development) would "ascend to the laboratory's orbit and complete a rendezvous and docking maneuver." A few weeks later, two more crew members would join the laboratory by the same method, completing the four-person crew. One new astronaut would enter the laboratory at each crew change, thus providing a check on the cumulative effects of weightlessness on the total capability of the crew. Three of the astronauts would occupy the space station for only parts of a year; only one crew member would try to complete a full year's mission. Every 90 days or less, an unmanned resupply spacecraft launched by an Atlas-Agena combination would be orbited and brought by radio control to a rendezvous with one of the laboratory's multiple docking ports. These ports would not only provide the means for the crew rotations and any

Spaceflight Revolution

emergency evacuations but also would serve as attachment sites for cargo and experiment modules.⁴¹

By the spring of 1963, Langley management judged the MORL design ready for industry evaluation. A contractor was to look for ways of improving and refining the concept into what engineers called a “baseline system,” that is, a detailed plan for an optimum MORL configuration. In late April, Langley asked the aerospace industry to submit brief proposals by 14 May for a contract study of “Manned Orbital Research Laboratory Systems” capable of sustaining such a rotating four-person crew in space for one year. The Request for Proposals outlined an industry competition in two phases: Phase I was to be an open competition for “comparative study of several alternative ways to obtain the orbital laboratory which is envisioned”; Phase II was to be a closed contest between the two winners of the first competition, for “preliminary design studies.” If all progressed well and NASA approved continued work on MORL, Langley might propose a follow-on to the second phase (Phase II-A) in which “a single contractor would be requested to synthesize into a mature concept” the design study that had been judged by NASA as the most feasible and to furnish a baseline configuration for a complete orbital laboratory system. Yet another phase (Phase II-B) might involve a final design stage, including test mock-ups of the laboratory and resupply spacecraft.⁴²

Phase I, the open competition, lasted only until mid-June 1963, when Langley Director Floyd Thompson announced that from the 11 proposals received, he had selected those from Boeing and Douglas as the winners. An 11-member in-house MORL Technology Steering Committee, chaired by Paul R. Hill of the Applied Materials and Physics Division space station office, had helped Thompson with the selection. At the same time that Thompson established this ad hoc steering committee, on 6 June, he also created a small MORL Studies Office, which comprised originally only six members and was to report directly to the director’s office. Thompson chose someone new to space station research to head the new office. William N. Gardner, formerly head of the Flight Physics Branch of the Applied Materials and Physics Division, and his six-person staff were to implement the management of the study contracts soon to be awarded to Boeing and Douglas. Thompson also formalized the many R&D efforts relating to a space station that had popped up inside the Applied Materials and Physics Division. He did this on 10 June by establishing a new 19-member Space Station Research Group, with Robert S. Osborne, a veteran of the center’s previous space station office, in charge.⁴³

Langley’s revised space station effort had not progressed without a hitch. Earlier in 1963, still in the immediate wake of the LOR decision, NASA headquarters had threatened the cancellation of all the MORL research at the research center. To have it reinstated even on a provisional basis, Langley Associate Director Charles J. Donlan, who from the start had lent strong support to space station research at Langley, traveled to Washington

with some of the most articulate members of the center's space station group for several meetings with old friends and other NASA officials. Donlan had always been a strong supporter of Langley's space station research, and together with associates he argued that a manned space station was still "the next logical step," after Apollo, and was thus likely to be a central part of the agency's post-Apollo planetary exploration. Donlan pointed out that a manned orbital laboratory offered perhaps the only way of making many necessary studies such as the effects of weightlessness.

Eventually, the lobbying paid off. In the spring of 1963, Bob Seamans issued MORL a reprieve, thus arranging for the authorization Langley needed to proceed with the first phase of the industry competition. At the start, that was the only permission Langley had. When Phase I started, NASA headquarters had not yet approved Phase II and had certainly not given the go-ahead for any follow-on phases.⁴⁴

Some of the ground rules for Phase I of the MORL competition conformed closely to the general specifications of the rotating hexagon, but others reflected some significant changes in the way Langley was now thinking about space stations. The major shift in thinking was the realization, gained by American and Soviet experiences with manned spaceflight, that humans could in fact function quite well in zero gravity, at least for several orbits, without serious ill effects. If a few days of weightlessness did not debilitate an astronaut, the same would most likely hold true for a couple of weeks. Further experimentation certainly had to be done to determine exactly how long humans could perform in zero gravity, but as reflected in MORL ground rules, researchers were growing confident that a person might be able to perform well in space for as long as a year. When Langley asked industry in April 1963 to design MORL with zero gravity as the primary operating mode, it was abandoning once and for all the long-held notion that a space station must continually rotate to provide artificial gravity.⁴⁵

Douglas and Boeing took Phase II of the competition seriously, each assembling its MORL personnel into a team situated at a single plant (Santa Monica for Douglas and Seattle for Boeing). Douglas had shown interest in a space station for some time; in 1958, the company had won a \$10,000 first prize in a contest for a design of "A Home in Space," which had been sponsored by the London *Daily Mail*.⁴⁶ Douglas had also been a serious bidder for the NASA contract for a six-month study of Berglund's rotating hexagon concept, which NASA had awarded to North American in the summer of 1961.⁴⁷ Boeing, on the other hand, was something of a newcomer to the field of space exploration. However, as the reader shall learn in more detail in the next chapter, the well-known airplane manufacturer was at this time completing a solid performance in the Bomarc missile program and was keen to be involved with the civilian space program. Not only did Boeing want the space station study contract, it also wanted to become the prime contractor for the ambitious Lunar Orbiter project, the unmanned

Spaceflight Revolution

Douglas engineers incorporated the idea of a two-person centrifuge into their winning MORL baseline configuration proposal in 1963 (right). The centrifuge (bottom, second cut-away from left) was to serve as a possible remedial or therapeutic device for enhancing the astronauts' tolerance to weightless conditions and for preconditioning crew members for the stresses of reentry.



L-63-1132

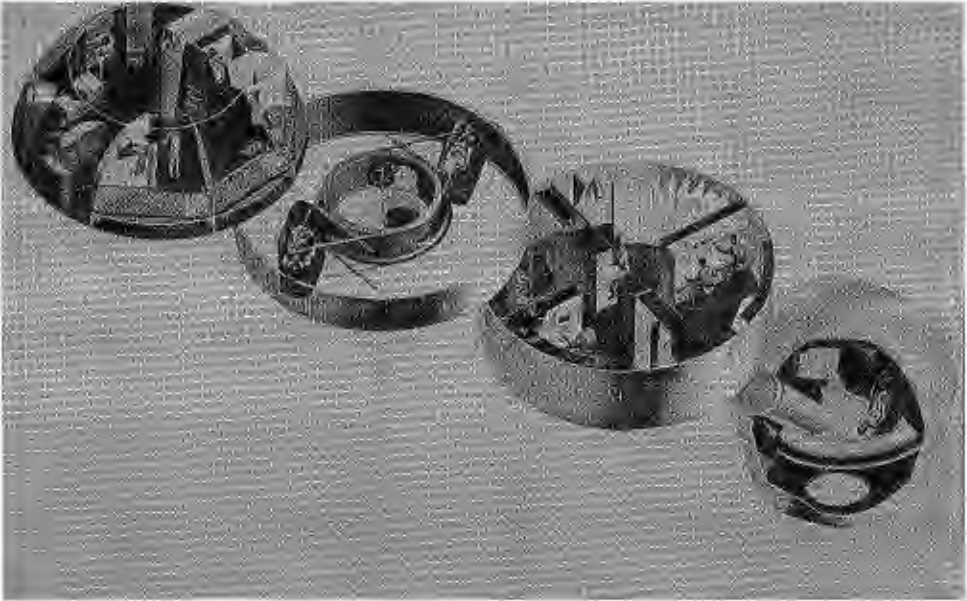

photographic mission to the moon which NASA was planning in order to select the best landing sites for Apollo.

A NASA "technical assessment team" consisting of 43 engineers (36 of them from Langley) and organized into four review panels ("Major Systems Configuration and Integration," "Subsystems Configuration and Integration," "Operations," and "Management and Planning") looked very carefully and fairly at both MORL studies in late September 1963 before recommending the Douglas study to the Langley director.⁴⁸ Perhaps NASA was reluctant to give a company inexperienced in space exploration the responsibility for doing two big new jobs at one time. (Boeing had just been awarded the contract for Lunar Orbiter.) More likely, however, the Douglas proposal was simply superior. Members of the MORL Studies Office at Langley had spent many hours at the plants of the contractors assessing their space station work, and they knew firsthand the capabilities of their assembled teams.

For the next two months, NASA Langley negotiated with Douglas (and with NASA headquarters, where the approval for Phase II-A was still uncertain) over the details of what would come next: a six-to-nine-month study at the end of which Douglas would furnish a baseline system that would be so detailed and fully documented that a final design could be prepared from it, if NASA so chose. By mid-December all the parties involved reached an agreement, and on 20 December, as a nice little Christmas present, NASA awarded Douglas a Phase II-A nine-month study contract worth just over \$1.4 million to refine its winning MORL concept.⁴⁹

The baseline configuration fleshed out by the Douglas engineers between December 1963 and August 1964 proved, not surprisingly, to be a mixture of old and new ideas. As had been the case with Langley's former pet concept, the Berglund/North American rotating hexagon, Douglas's baseline facility would be carried into orbit as a unit aboard a Saturn launch vehicle. As had been proposed for the hexagon, the first generation MORL would be powered by solar cells, but with either a nuclear reactor or isotope Brayton cycle system phased in at an early date. The same life-support systems for meeting the physical needs of a small crew in a shirt-sleeve working environment would also be part of MORL. As before, many of MORL's design features, such as separate zero-gravity and artificial-gravity operational modes, would in effect serve as experiments that would yield data applicable to other manned space programs.

Because Langley's thinking changed about what was best for a space station in the age of Apollo, Douglas's baseline system for MORL involved key differences from all the previous space station concepts. Unlike the earlier configurations, which had unitized structures, MORL would consist of a series of discrete modules. The modular approach would promote greater flexibility of function: MORL could grow with evolving space technology and over time serve multiple purposes for a varied constituency, including perhaps the DOD. The DOD had been carrying out its own manned space

Spaceflight Revolution

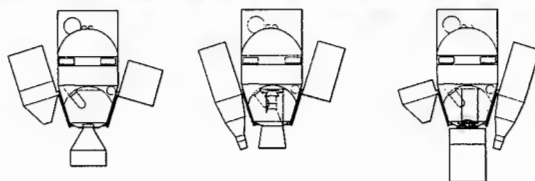
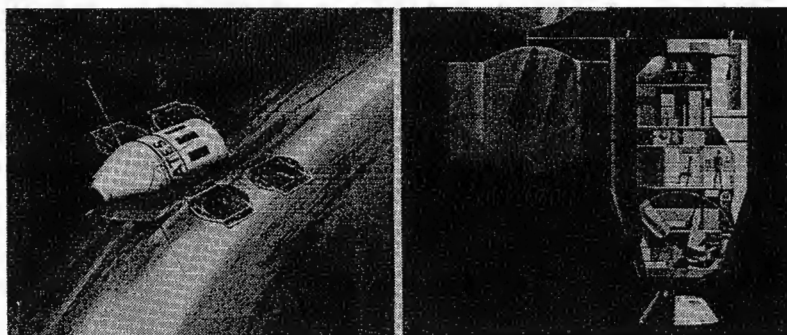
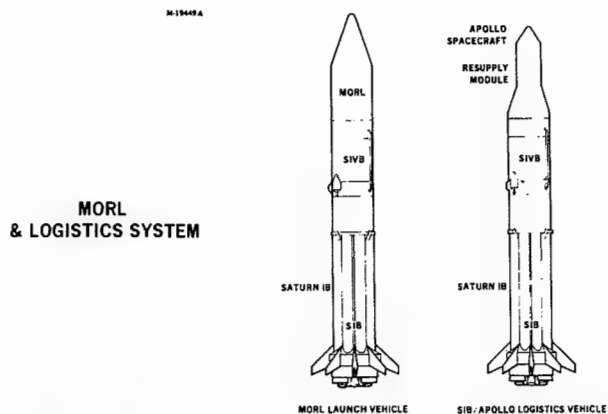

According to the briefing manual submitted by Douglas to NASA Langley in August 1964, MORL “provides a flexible, expandable facility developed in a manner similar to current submarine concepts that permit redundancy of life-support equipment and evacuation from one compartment to another.” As shown in this illustration from the manual, MORL was to be launched by an Apollo Saturn SIB.

station R&D since the Military Test Space Station (MTSS) project of the late 1950s and was currently involved in a study of what it called the National Orbiting Space Station (NOSS).⁵⁰

Besides benefitting the military, the MORL could serve the progress of science, in general. This was a mission capability that had not been

Skipping "The Next Logical Step"



L-64-841

Two Langley engineers test an experimental air lock between an arriving spacecraft and a space station portal in January 1964.

especially emphasized in the earlier space station studies. When considering the inflatable torus and rotating hexagon, Langley researchers and their contractors had envisioned only a limited role for general scientific experimentation aboard the station, but the Douglas engineers were beginning to see the MORL as a facility for research covering the spectrum of scientific disciplines. In addition to carrying one or more astronomical telescopes (a capability that proponents of a space station had in fact been pushing from the start), the MORL could be designed to have a self-contained module for biological studies involving animals, plants, and bacteria. Such research had potential applications not only in basic life sciences research but also in medicine and pharmaceuticals. For geologists, oceanographers, and meteorologists, Douglas provided a specialized nine-lens camera system for multiband spectral reconnaissance of earth features and weather systems. A special radar system could be placed on board to garner the data necessary for large-scale topographical mapping.

This was not all that the MORL could provide. The orbital station would also be the ideal place to study subsystems for interplanetary vehicles and their propulsion systems, technologies that could not be tested adequately on the ground. Douglas's integrated plan even included using the MORL in lunar orbit to provide surface observation and mapping, landing site selection, and LEM support. With such capabilities, NASA might not need

Spaceflight Revolution



L-64-4636

William N. Gardner, head of the MORL Studies Office, explains the interior design of the space station at the 1964 NASA inspection.

the unmanned Lunar Orbiter program. If equipped with a state-of-the-art landing stage, the MORL could land on the moon and become a long-term base for exploration. MORL could serve as the jumping off point for a manned mission to Mars and as a module of a planetary-mission vehicle in which a crew would investigate the physical environment and assess the habitability of a selected planet.⁵¹

In fact, as Douglas touted it, there was little that the MORL system could not do, if NASA wanted it done. Thus, while trying to stay within the political and economic framework of Apollo, the proponents of the MORL were actually demonstrating how a versatile space station could greatly expand U.S. capabilities in space and make new exploration possible. The MORL would have spin-off studies in areas such as biology, medicine, and possibly industrial manufacturing, which would ultimately benefit all sectors of society. The lunar landing program, by itself, would make few of those things possible. But in 1964 that was a point that neither the Langley space station advocates nor their counterparts in industry dared to make, given the national commitment to Apollo.

Keeping the "R" Alive

All in all, Langley was happy with the baseline system that Douglas submitted to NASA in August 1964 and was interested in moving to Phase II-B in which full-scale mock-ups of the laboratory would be tested in preparation for a final MORL design. By 1964, however, MORL was facing stiff competition from other space station concepts, not to mention space projects proposed by other NASA centers.

As Phase II-A of the MORL began in early 1964, the Office of Manned Space Flight at NASA headquarters was considering what to do next with several other space station designs. Most of these ideas came from either Houston or Huntsville. The most ambitious of these schemes called for a Large Orbiting Research Laboratory (LORL), a huge structure to be launched unmanned by a Saturn V, with a volume more than seven times that of MORL (67,300 cubic feet compared with MORL's 9000) and a weight more than 10 times greater (74,600 pounds versus 6800). According to the plan, LORL would be capable of holding a 24-person crew for five years; as such, it was the "Cadillac" of NASA's space station concepts at the time. At the other end of the design spectrum was a "Volkswagon" version known as "Apollo X." This space station (only 600 cubic feet in volume) was based entirely on Apollo technology; a modified Apollo command module would be used as a small orbital workshop. Manned from time of launch, Apollo X would thus be a small "limited-life" laboratory serving a crew of two for 30 to 120 days. Between these two extremes were various designs for some type of Apollo Orbital Research Laboratory (AORL), a medium-size station (5600 cubic feet in volume) that would have an extended life of two years, with a crew of three to six.⁵²

Besides the NASA concepts, military space station ideas also had to be considered. Interagency agreements had been made related to the Gemini program requiring that all planning for manned earth-orbital missions and supporting technology be coordinated between NASA and the DOD. As mentioned earlier, the DOD, particularly the air force, was busy conducting its own space station studies. By late 1963, experts in the DOD were keenly interested in the potential military applications of MORL or of a revised MORL design for an air force Gemini-based Manned Orbiting Laboratory (MOL) in which NASA's research component was left out. Even before the Phase II contract was awarded to Douglas, managers in the OART at NASA headquarters had been referring not to MORL studies, but simply to MOL, which Secretary of Defense McNamara and NASA Administrator Webb were coming to see as a way of combining DOD and NASA first-generation space station objectives.⁵³

Surprisingly, Langley researchers seem to have accepted the shift from MORL to MOL without complaint. In the minutes of the 28 October 1963 meeting of the Langley MORL Technology Steering Committee, secretary

Spaceflight Revolution



L-65-7433

The MORL-Saturn IB launch combination undergoes aerodynamic testing in the 8-Foot Transonic Tunnel in October 1965.

John R. Dawson noted with emphasis that MORL was being “redesignated MOL” and that “MOL Phase IIA was now planned so as to fit with DOD coordination requirements.” In all the committee minutes following that meeting, Dawson always referred to “MOL Phase II” rather than to MORL Phase II.⁵⁴ So, too, would the Langley press release of 2 December 1963 refer to MOL Phase II. (In this release, NASA announced that Douglas had won the second round of competition over Boeing for a “follow-on study contract for refinement and evaluation of a NASA Manned Orbital Laboratory concept.”) Somehow the “R” in the space station plan was being erased as Langley tried to justify a space station as part of the Apollo-driven national space program.

At Langley, researchers did what they could to keep the spirit of MORL alive. Looking beyond the industry study contracts, Langley engineers and managers invested thousands of hours in MORL/MOL research. In 1963 and 1964, basic studies continued on a broad front.

In the area of life-support systems, Langley researchers tried to stay particularly active. As outlined earlier in this chapter, Langley early on had taken the lead among the NASA centers in this vital field. In 1963, Langley researchers wanted to extend their efforts with a fully operational prototype of a space station life-support system. In such a prototype, they could



L-66-7850

Langley's Otto Trout suggested as early as 1963 that zero-gravity activities could be simulated by immersing astronauts in a large tank of water. Years later, Marshall Space Flight Center turned Trout's abortive idea into a major component of NASA's astronaut training program.

test all the integrated mechanisms for water management and sanitation, oxygen regeneration, ridding the system of waste heat and gases, and all other required functions. They wanted a ground test facility—a wind tunnel of sorts but one equipped for the physiology of humans rather than for the physics of air molecules.

Langley explored several options before it found the right facility to meet these research needs. Engineers working with the MORL Studies Office built a small life-support test tank but found that the device could not be used in manned tests because of safety concerns. As William Gardner, head of the MORL Studies Office remembers, “Essentially, the medical profession killed it. The medical experts who came in as consultants would not endorse anything we were doing. We couldn't get the medical people to say it would be safe to do the tests.”⁵⁵ Another bold idea came from Otto Trout, an ingenious engineer working in the Space Systems Division. Trout suggested that the space station group simulate zero gravity by immersing test subjects in a tank of water for long periods. Robert Osborne curtly dismissed Trout's novel idea, a hasty decision that Osborne came to regret when engineers at Marshall Space Flight Center took up the idea and turned it into a major component of NASA's astronaut training program.⁵⁶

Osborne and others did not want Gardner's little tank or Trout's big tank of water but sought an enclosed, self-sustaining life-support system in which four human subjects could live for as long as six months. A rivalry existed

Spaceflight Revolution

The \$2.3 million ILSS arrives at Langley by barge (right) from its manufacturer, the Convair Division of General Dynamics, in August 1965. Below is the home of the huge 30-ton life-support tank in Building 1250. Test subjects occupied this facility for as long as 28 days at a time.



L-65-6054

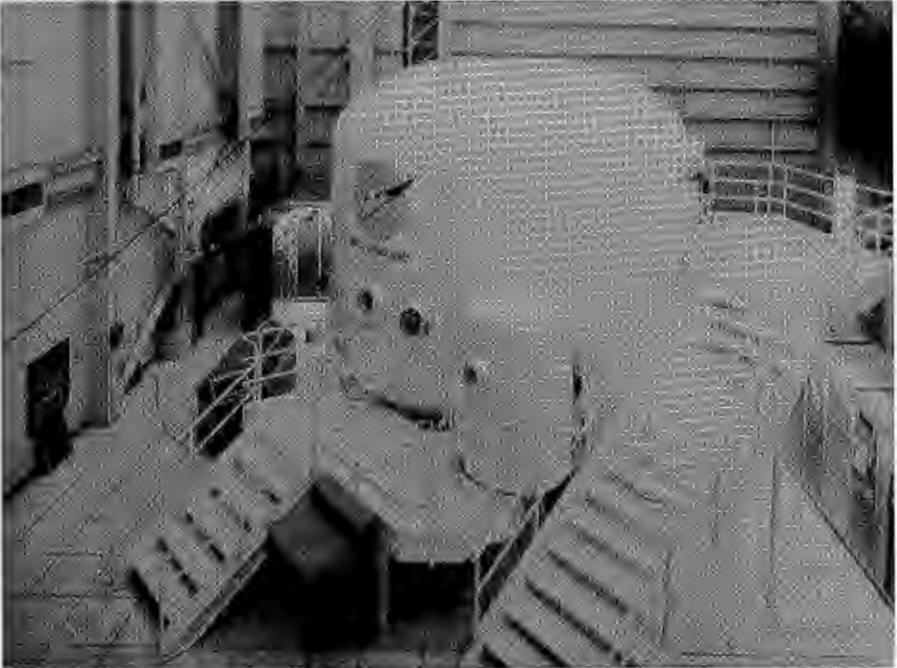

L-70-566

Skipping "The Next Logical Step"

between Gardner's MORL group and Osborne's life-support studies group. In this case the Osborne group won. In late June 1963, he and his colleagues got their wish when NASA awarded a contract to the Astronautics Division of the General Dynamics Corporation for the design and construction of an Integrative Life Support System (ILSS). Funded by the OART's director of Biotechnology and Human Research, this facility was to be built by General Dynamics at its plant in San Diego and shipped to Langley at a total cost of \$2.3 million.⁵⁷

Two years passed before General Dynamics finished the ILSS unit. The unique structure stood 18 feet tall, weighed 30 tons, and was housed in a cylindrical tank 18 feet in diameter. When the big chamber arrived by barge at the dock of Langley AFB in August 1965, a more curious structure had not been delivered since the 85-ton pressure shell for the laboratory's historic Variable-Density Tunnel had arrived atop a railcar from the Newport News Shipyard and Dry Dock Co. in February 1922.

The ILSS did not prove to be the landmark facility that the Variable-Density Tunnel became, but it did contribute significant data. In the years following its long-anticipated arrival, manned and unmanned tests in the big test chamber provided a wealth of new information about how various life-support systems would work individually and together. The longest human occupancy experiment lasted 28 days. The ILSS test program even included microbiological experiments on possible toxic contaminants in space. Langley management heartily supported the ILSS program, thus allowing it to encompass the efforts of dozens of Langley staff members in the Space Systems and Instrument Research divisions. Associate Director Charles Donlan even worked personally on some aspects of the project.⁵⁸

By the time ILSS came on-line at Langley in August 1965, however, NASA knew that its space station research must, out of political and economic necessity, become more sharply defined. With costs for Gemini and Apollo rapidly outstripping early estimates and the nation in an increasingly expensive war in Vietnam, the space agency realized that if any manned orbiting facility was to obtain funding and become a reality, it would have to be a part of Apollo.

Understanding Why and Why Not

The economical Apollo Extension System became NASA's surrogate choice for its first orbiting space station. This crushed Langley researchers' dreams for MORL. Instead of a versatile laboratory with an extended life of five years in which all sorts of experiments could be done, NASA would settle, at least for the time being, for a small space station with a limited life. This station would be launched as soon as possible after Apollo astronauts set foot on the moon. For the Apollo Extension System, NASA headquarters asked Langley researchers to devise potential mission

Spaceflight Revolution

experiments, tempting them with the responsibility of acting as principal investigators. Osborne's panel on space station experiments responded by collecting experiments in 11 categories ranging from regenerative life-support systems to extravehicular activities, horizon sensing, and radiation effects.⁵⁹

Two years would pass before a new president, Richard Nixon, and the Congress extinguished what remained of Langley's hopes for a multifaceted U.S. space program. In 1967 the Apollo Extension System became the Apollo Applications Program. NASA headquarters called upon Langley, Houston, and Marshall to carry out independent studies to "identify the most desirable Agency program for the Saturn workshop," noting "the constraints of projected funding limitation." The outcome at Langley was one of the research center's last major contributions to space station development: an "Intermediate Orbital Workshop System Study" issued by the MORL Studies Office on 28 June 1968.⁶⁰

The concluding remarks of this 1968 in-house report encapsulate the years of hard work and intellectual energy Langley designers and researchers had devoted to the idea of a U.S. civilian space station. The report described a versatile facility that "should be and can be inherently capable of growth into the ultimate space station which will provide broad capability manned systems." True to the original Langley vision, it called for a two-phase program that would begin with a manned orbiting workshop, followed by a space station similar to MORL. The report emphasized that "definition of a *real* manned experiment program and supporting requirements is mandatory to the true understanding of spacecraft system needs and total flight system scope."⁶¹

Not even the economical first phase came to pass as conceived. In late 1968, a spending-weary Congress slashed the budget of the Apollo Applications Program to one-third of the NASA request. A down-scaled concept, the Skylab orbital workshop, would be launched in May 1973, carrying with it an experiment package developed by Langley researchers. By that time, however, with personnel reductions and program shifts resulting from severe budget cuts within NASA, Langley was largely out of the space station business. When so-called Phase B Definition Studies for NASA's space station program began in 1969, they were managed by the Marshall and Johnson centers.⁶²

Bigger ideas were stealing the thunder from the Langley concept. At Houston in 1968, engineers were working on plans for a huge "Space Base" weighing a million pounds, with room for thousands of pounds of experiments, and a crew of 75 to 100 people. According to the plan, the Space Base would provide 1 G by spinning at 3.5 rpm at the 240-foot radius of the living module and would operate "on a permanent basis to take advantage of the economics of size, centralization, and permanency." The base would be constructed in an orbital buildup of hardware delivered by no less than three Saturn launches.⁶³

Skipping "The Next Logical Step"

Although everyone recognized that this large space station would have to come after the Apollo Applications workshop, Houston's grandiose idea nonetheless had "a significant effect on agency planning"—and one that in the end did not help the ultimate cause of the space station program.⁶⁴ When Phase B Definition began in late 1969, with major contracts awarded to McDonnell Douglas and North American Rockwell, the notion of a large station held sway. The contractors were asked to explore the feasibility of a smaller but still rather large station, 33 feet in diameter, to be launched by a Saturn V and manned initially by a crew of 12. The NASA/industry space station teams were to do this "in concert with studies of future large space bases," involving crews of 100 people or more, as well as with manned missions to Mars. Crews for some of these space base concepts exceeded 100 and included plans for an advanced logistics system, which was soon to be named the "Space Shuttle."⁶⁵

In 1971, when the decision was made to go forward with the development of the manned Space Shuttle, NASA redirected its space station contractors to consider a modular design, with the modules to be placed in orbit, not by Saturns, but by a totally reusable shuttle. The purpose of Phase B from that point on, into 1972, was to define the modular concepts. A large space station with the Space Shuttle to assemble and service it was now "the next logical step" in NASA's manned space program following the Apollo Applications Program and Skylab.

Politics and budget pressures, however, once again meant a missed step. The nation had neither the will nor the money for NASA's entire mission package. As Howard McCurdy points out in his 1990 analysis *The Space Station Decision: Incremental Politics and Technological Choice*, NASA officials, having failed to win the support of the Nixon administration for their internal long-range plan, decided to shift their strategy. "Rather than seek a comprehensive, Apollo-style commitment, they decided to pursue the steps in their plan one by one."⁶⁶ NASA would ask first for an economical Space Transportation System, the Shuttle, then they would ask for the space station. The result, after Nixon accepted NASA's compromise, meant that "the next logical step" would be skipped once again.

Lost in Space?

The majority of Langley researchers involved in the pioneering space station studies of the early 1960s believe that the decision not to develop and deploy the MORL was a major national mistake. As many of them have asserted in retrospect, the Soviet's tremendously successful MIR space station of the 1980s (the spacious follow-on to the more primitive Salyuts first launched in 1971) "would prove to be almost exactly like what MORL would have been."⁶⁷ W. Ray Hook, a member of Langley's MORL Studies Office, expresses the general sentiment of Langley researchers:

Spaceflight Revolution

Skipping over a space station for a second time left William N. Gardner, head of Langley's MORL office, with a bitter taste for his pioneering work of the 1960s and a judgment that NASA, unlike NACA, was too much the creature of presidential projects—or the lack of them.

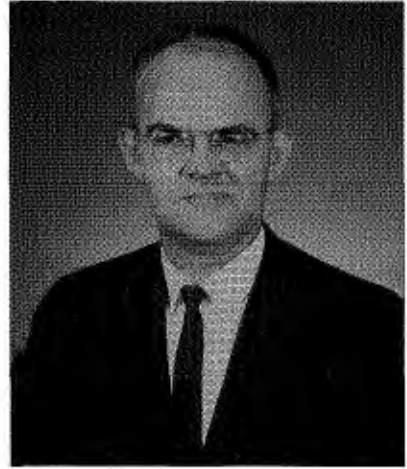

L-66-7229

Our goal was to get one man in space for one year. That was the simple objective. Of course, it has since gotten a lot more complicated. I have often thought that if we'd stuck with that simple-minded objective, we would have, thirty years later, one man in space for one year, which we don't.⁶⁸

If the modular MORL had been ready for deployment on the heels of Skylab, as MIR was ready to go after the Salyuts, the United States like the Soviets would have amassed countless man-hours in space and conducted numerous useful experiments. If the country had supported MORL, it might have been easier to design and justify Space Station *Freedom*, and instead of being in the present position of considering the purchase of a MIR from the former Soviet Union and proceeding toward an international space station, *Alpha*, the United States might today be operating its own station.

The most bitter among Langley space station enthusiasts feel that the decisions regarding the station were not only mistakes but also symptoms of a basic flaw in NASA's organizational character. "It finally dawned on me," explains William Gardner, the head of the MORL Studies Office, "that NASA wasn't intended to be a real federal agency." NASA did not enjoy a long-term goal like the former NACA—an agency designed "to supervise and direct the scientific study of the problems of flight with a view to their practical solution," or even like the FAA, whose job was to make air travel effective and safe. "NASA was just a project of the presidential administration," and under Presidents Kennedy, Johnson, and Nixon, the project was "just to put a man on the moon." "We do spectacular things when the Administration wants spectacular things done," Gardner challenges, and when it does not, "we don't really have a mandate."⁶⁹

Skipping “The Next Logical Step”

But Langley researchers, out of technological conviction or political naiveté, or both, kept working on the space station as if they had such a mandate. The effort was not in vain. In persisting with their design and redesign of space stations and seeking to understand how humans could live and work in space, they contributed to the successes of Apollo, Skylab, and the Space Shuttle, and they laid a solid foundation upon which to build when NASA in the early 1980s created a new Space Station Task Force and once again began examining the program options for “the next logical step”—a step that may in its own time be skipped over for something else. In the wake of the spaceflight revolution, it would take all the running space station researchers could do, just to keep in the same place.

To Behold the Moon: The Lunar Orbiter Project

But, Cliff, you said we weren't going to improvise like this ...

But, listen to what I say now! We've worked out the numbers. It's worth the risk.

—Conversation between Boeing engineer project manager Robert J. Helberg and Clifford H. Nelson, head of Langley's Lunar Orbiter Project Office, concerning a change in the mission plan for *Lunar Orbiter I*.

The bold plan for an Apollo mission based on LOR held the promise of landing on the moon by 1969, but it presented many daunting technical difficulties. Before NASA could dare attempt any type of lunar landing, it had to learn a great deal more about the destination. Although no one believed that the moon was made of green cheese, some lunar theories of the early 1960s seemed equally fantastic. One theory suggested that the moon was covered by a layer of dust perhaps 50 feet thick. If this were true, no spacecraft would be able to safely land on or take off from the lunar surface. Another theory claimed that the moon's dust was not nearly so thick but that it possessed an electrostatic charge that would cause it to stick to the windows of the lunar landing vehicle, thus making it impossible for the astronauts to see out as they landed. Cornell University astronomer Thomas Gold warned that the moon might even be composed of a spongy material that would crumble upon impact.¹

At Langley, Dr. Leonard Roberts, a British mathematician in Clint Brown's Theoretical Mechanics Division, pondered the riddle of the lunar

Spaceflight Revolution

surface and drew an equally pessimistic conclusion. Roberts speculated that because the moon was millions of years old and had been constantly bombarded without the protection of an atmosphere, its surface was most likely so soft that any vehicle attempting to land on it would sink and be buried as if it had landed in quicksand. After the president's commitment to a manned lunar landing in 1961, Roberts began an extensive three-year research program to show just what would happen if an exhaust rocket blasted into a surface of very thick powdered sand. His analysis indicated that an incoming rocket would throw up a mountain of sand, thus creating a big rim all the way around the outside of the landed spacecraft. Once the spacecraft settled, this huge bordering volume of sand would collapse, completely engulf the spacecraft, and kill its occupants.²

Telescopes revealed little about the nature of the lunar surface. Not even the latest, most powerful optical instruments could see through the earth's atmosphere well enough to resolve the moon's detailed surface features. Even an object the size of a football stadium would not show up on a telescopic photograph, and enlarging the photograph would only increase the blur. To separate fact from fiction and obtain the necessary information about the craters, crevices, and jagged rocks on the lunar surface, NASA would have to send out automated probes to take a closer look.

The first of these probes took off for the moon in January 1962 as part of a NASA project known as Ranger. A small 800-pound spacecraft was to make a "hard landing," crashing to its destruction on the moon. Before Ranger crashed, however, its on-board multiple television camera payload was to send back close views of the surface—views far more detailed than any captured by a telescope. Sadly, the first six Ranger probes were not successful. Malfunctions of the booster or failures of the launch-vehicle guidance system plagued the first three attempts; malfunctions of the spacecraft itself hampered the fourth and fifth probes; and the primary experiment could not take place during the sixth Ranger attempt because the television equipment would not transmit. Although these incomplete missions did provide some extremely valuable high-resolution photographs, as well as some significant data on the performance of Ranger's systems, in total the highly publicized record of failures embarrassed NASA and demoralized the Ranger project managers at JPL. Fortunately, the last three Ranger flights in 1964 and 1965 were successful. These flights showed that a lunar landing was possible, but the site would have to be carefully chosen to avoid craters and big boulders.³

JPL managed a follow-on project to Ranger known as Surveyor. Despite failures and serious schedule delays, between May 1966 and January 1968, six Surveyor spacecraft made successful soft landings at predetermined points on the lunar surface. From the touchdown dynamics, surface-bearing strength measurements, and eye-level television scanning of the local surface conditions, NASA learned that the moon could easily support the impact and the weight of a small lander. Originally, NASA also

To Behold the Moon: The Lunar Orbiter Project

planned for (and Congress had authorized) a second type of Surveyor spacecraft, which instead of making a soft landing on the moon, was to be equipped for high-resolution stereoscopic film photography of the moon's surface from lunar orbit and for instrumented measurements of the lunar environment. However, this second Surveyor or "Surveyor Orbiter" did not materialize. The staff and facilities of JPL were already overburdened with the responsibilities for Ranger and "Surveyor Lander"; they simply could not take on another major spaceflight project.⁴

In 1963, NASA scrapped its plans for a Surveyor Orbiter and turned its attention to a lunar orbiter project that would not use the Surveyor spacecraft system or the Surveyor launch vehicle, Centaur. Lunar Orbiter would have a new spacecraft and use the Atlas-Agena D to launch it into space. Unlike the preceding unmanned lunar probes, which were originally designed for general scientific study, Lunar Orbiter was conceived after a manned lunar landing became a national commitment. The project goal from the start was to support the Apollo mission. Specifically, Lunar Orbiter was designed to provide information on the lunar surface conditions most relevant to a spacecraft landing. This meant, among other things, that its camera had to be sensitive enough to capture subtle slopes and minor protuberances and depressions over a broad area of the moon's front side. As an early working group on the requirements of the lunar photographic mission had determined, Lunar Orbiter had to allow the identification of 45-meter objects over the entire facing surface of the moon, 4.5-meter objects in the "Apollo zone of interest," and 1.2-meter objects in all the proposed landing areas.⁵

Five Lunar Orbiter missions took place. The first launch occurred in August 1966 within two months of the initial target date. The next four Lunar Orbiters were launched on schedule; the final mission was completed in August 1967, barely a year after the first launch. NASA had planned five flights because mission reliability studies had indicated that five might be necessary to achieve even one success. However, all five Lunar Orbiters were successful, and the prime objective of the project, which was to photograph in detail all the proposed landing sites, was met in three missions. This meant that the last two flights could be devoted to photographic exploration of the rest of the lunar surface for more general scientific purposes. The final cost of the program was not slight: it totaled \$163 million, which was more than twice the original estimate of \$77 million. That increase, however, compares favorably with the escalation in the price of similar projects, such as Surveyor, which had an estimated cost of \$125 million and a final cost of \$469 million.

In retrospect, Lunar Orbiter must be, and rightfully has been, regarded as an unqualified success. For the people and institutions responsible, the project proved to be an overwhelmingly positive learning experience on which greater capabilities and ambitions were built. For both the prime contractor, the Boeing Company, a world leader in the building of

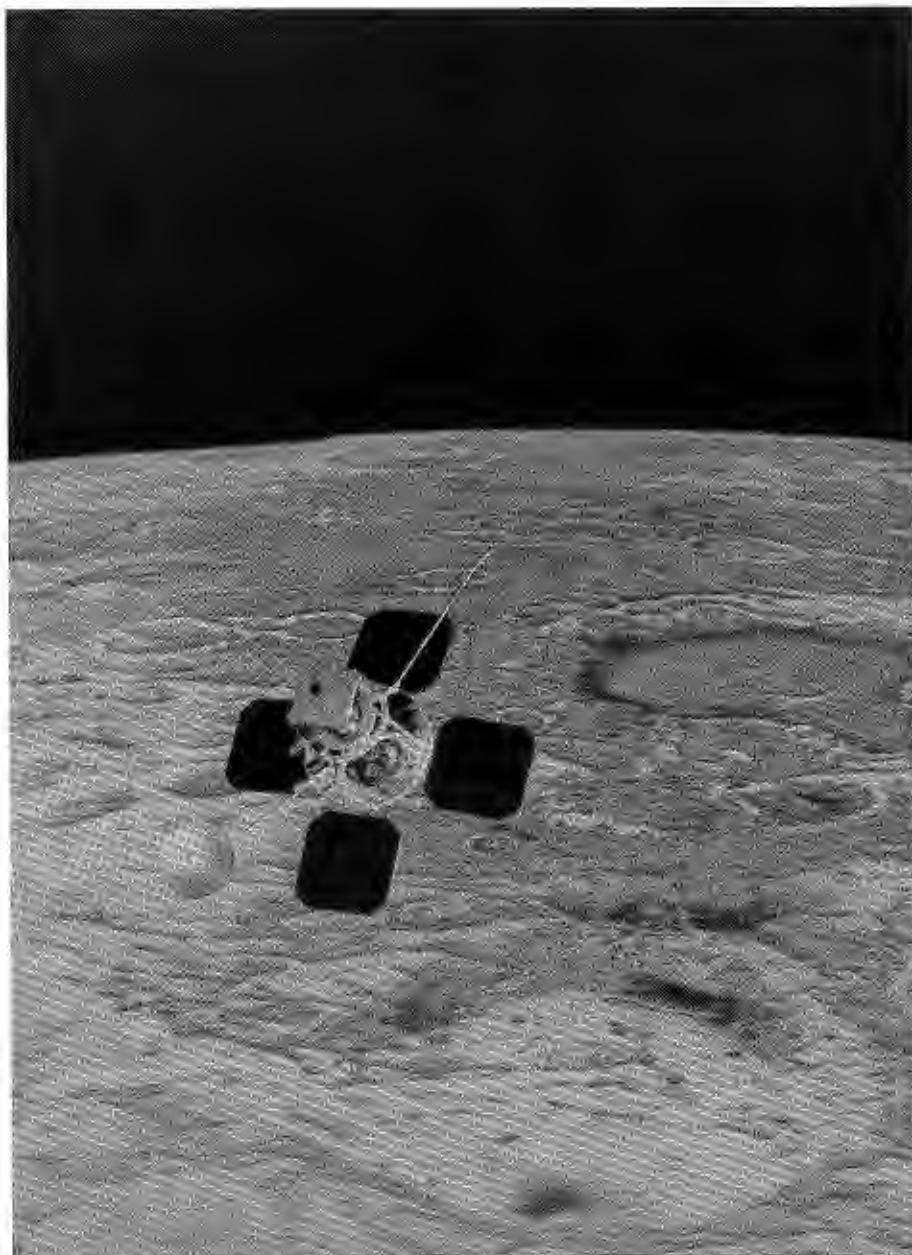

L-66-1571

The most successful of the pre-Apollo probes, Lunar Orbiter mapped the equatorial regions of the moon and gave NASA the data it needed to pinpoint ideal landing spots.

To Behold the Moon: The Lunar Orbiter Project

airplanes, and the project manager, Langley Research Center, a premier aeronautics laboratory, involvement in Lunar Orbiter was a turning point. The successful execution of a risky enterprise became proof positive that they were more than capable of moving into the new world of deep space. For many observers as well as for the people who worked on the project, Lunar Orbiter quickly became a model of how to handle a program of space exploration. Its successful progress demonstrated how a clear and discrete objective, strong leadership, and positive person-to-person communication skills can keep a project on track from start to finish.⁶

Many people inside the American space science community believed that neither Boeing nor Langley was capable of managing a project like Lunar Orbiter or of supporting the integration of first-rate scientific experiments and space missions. After NASA headquarters announced in the summer of 1963 that Langley would manage Lunar Orbiter, more than one space scientist was upset. Dr. Harold C. Urey, a prominent scientist from the University of California at San Diego, wrote a letter to Administrator James Webb asking him, "How in the world could the Langley Research Center, which is nothing more than a bunch of plumbers, manage this scientific program to the moon?"⁷

Urey's questioning of Langley's competency was part of an unfolding debate over the proper place of general scientific objectives within NASA's spaceflight programs. The U.S. astrophysics community and Dr. Homer E. Newell's Office of Space Sciences at NASA headquarters wanted "quality science" experiments incorporated into every space mission, but this caused problems. Once the commitment had been made to a lunar landing mission, NASA had to decide which was more important: gathering broad scientific information or obtaining data required for accomplishing the lunar landing mission. Ideally, both goals could be incorporated in a project without one compromising the other, but when that seemed impossible, one of the two had to be given priority. The requirements of the manned mission usually won out. For Ranger and Surveyor, projects involving dozens of outside scientists and the large and sophisticated Space Science Division at JPL, that meant that some of the experiments would turn out to be less extensive than the space scientists wanted.⁸ For Lunar Orbiter, a project involving only a few astrogeologists at the U.S. Geological Survey and a very few space scientists at Langley, it meant, ironically, that the primary goal of serving Apollo would be achieved so quickly that general scientific objectives could be included in its last two missions.

The "Moonball" Experiment

Langley management had entered the fray between science and project engineering during the planning for Project Ranger. At the first Senior Council meeting of the Office of Space Sciences (soon to be renamed

Spaceflight Revolution

the Office of Space Sciences and Applications [OSSA]) held at NASA headquarters on 7 June 1962, Langley Associate Director Charles Donlan had questioned the priority of a scientific agenda for the agency's proposed unmanned lunar probes because a national commitment had since been made to a manned lunar landing. The initial requirements for the probes had been set long before Kennedy's announcement, and therefore, Donlan felt NASA needed to rethink them. Based on his experience at Langley and with Gilruth's STG, Donlan knew that the space science people could be "rather unbending" about adjusting experiments to obtain "scientific data which would assist the manned program." What needed to be done now, he felt, was to turn the attention of the scientists to exploration that would have more direct applications to the Apollo lunar landing program.⁹

Donlan was distressed specifically by the Office of Space Sciences' recent rejection of a lunar surface experiment proposed by a penetrometer feasibility study group at Langley. This small group, consisting of half a dozen people from the Dynamic Loads and Instrument Research divisions, had devised a spherical projectile, dubbed "Moonball," that was equipped with accelerometers capable of transmitting acceleration versus time signatures during impact with the lunar surface. With these data, researchers could determine the hardness, texture, and load-bearing strength of possible lunar landing sites. The group recommended that Moonball be flown as part of the follow-on to Ranger.¹⁰

A successful landing of an intact payload required that the landing loads not exceed the structural capabilities of the vehicle and that the vehicle make its landing in some tenable position so it could take off again. Both of these requirements demanded a knowledge of basic physical properties of the surface material, particularly data demonstrating its hardness or resistance to penetration. In the early 1960s, these properties were still unknown, and the Langley penetrometer feasibility study group wanted to identify them. Without the information, any design of Apollo's lunar lander would have to be based on assumed surface characteristics.¹¹

In the opinion of the Langley penetrometer group, its lunar surface hardness experiment would be of "general scientific interest," but it would, more importantly, provide "timely engineering information important to the design of the Apollo manned lunar landing vehicle."¹² Experts at JPL, however, questioned whether surface hardness was an important criterion for any experiment and argued that "the determination of the terrain was more important, particularly for a horizontal landing."¹³ In the end, the Office of Space Sciences rejected the Langley idea in favor of making further seismometer experiments, which might tell scientists something basic about the origins of the moon and its astrogeological history.*

* Later in Apollo planning, engineers at the Manned Spacecraft Center in Houston thought that deployment of a penetrometer from the LEM during its final approach to landing would prove useful. The penetrometer would "sound" the anticipated target and thereby determine whether surface conditions

To Behold the Moon: The Lunar Orbiter Project



L-67-8553

Associate Director Charles J. Donlan understood that the requirements of the manned lunar landing took priority over pure science experiments.

For engineer Donlan, representing a research organization like Langley dominated by engineers and by their quest for practical solutions to applied problems, this rejection seemed a mistake. The issue came down to what NASA needed to know now. That might have been science before Kennedy's commitment, but it definitely was not science after it. In Donlan's view, Langley's rejected approach to lunar impact studies had been the correct one. The consensus at the first Senior Council meeting, however, was that "pure science experiments will be able to provide the engineering answers for Project Apollo."¹⁴

Over the next few years, the engineering requirements for Apollo would win out almost totally. As historian R. Cargill Hall explains in his story of Project Ranger, a "melding" of interests occurred between the Office

were conducive to landing. Should surface conditions prove unsatisfactory, the LEM could be flown to another spot or the landing could be aborted. In the end, NASA deemed the experiment unnecessary. What the Surveyor missions found out about the nature of the lunar soil (that it resembled basalt and had the consistency of damp sand) made NASA so confident about the hardness of the surface that it decided this penetrometer experiment could be deleted. For more information, see Ivan D. Ertel and Roland W. Newkirk, *The Apollo Spacecraft: A Chronology*, vol. 4, NASA SP-4009 (Washington, 1978), p. 24.

Spaceflight Revolution



L-63-1777



L-67-4028

Langley gathered information specifically for the accomplishment of Apollo. Top, a Langley engineer monitors the structural dynamics of a simulated lunar landing in early 1963. Bottom, Lunar Orbiter III maps a potential Apollo landing site. The large crater is Kepler, which is 30 miles across.

To Behold the Moon: The Lunar Orbiter Project

of Space Sciences and the Office of Manned Space Flight followed by a virtually complete subordination of the scientific priorities originally built into the unmanned projects. Those priorities, as important as they were, “quite simply did not rate” with Apollo in importance.¹⁵

Initiating Lunar Orbiter

The sensitive camera eyes of the Lunar Orbiter spacecraft carried out a vital reconnaissance mission in support of the Apollo program. Although NASA designed the project to provide scientists with quantitative information about the moon’s gravitational field and the dangers of micrometeorites and solar radiation in the vicinity of the lunar environment, the primary objective of Lunar Orbiter was to fly over and photograph the best landing sites for the Apollo spacecraft. NASA suspected that it might have enough information about the lunar terrain to land astronauts safely without the detailed photographic mosaics of the lunar surface compiled from the orbiter flights, but certainly landing sites could be pinpointed more accurately with the help of high-resolution photographic maps. Lunar Orbiter would even help to train the astronauts for visual recognition of the lunar topography and for last-second maneuvering above it before touchdown.

Langley had never managed a deep-space flight project before, and Director Floyd Thompson was not sure that he wanted to take on the burden of responsibility when Oran Nicks, the young director of lunar and planetary programs in Homer Newell’s Office of Space Sciences, came to him with the idea early in 1963. Along with Newell’s deputy, Edgar M. Cortright, Nicks was the driving force behind the orbiter mission at NASA headquarters. Cortright, however, first favored giving the project to JPL and using Surveyor Orbiter and the Hughes Aircraft Company, which was the prime contractor for Surveyor Lander. Nicks disagreed with this plan and worked to persuade Cortright and others that he was right. In Nicks’ judgment, JPL had more than it could handle with Ranger and Surveyor Lander and should not have anything else “put on its plate,” certainly not anything as large as the Lunar Orbiter project. NASA Langley, on the other hand, besides having a reputation for being able to handle a variety of aerospace tasks, had just lost the STG to Houston and so, Nicks thought, would be eager to take on the new challenge of a lunar orbiter project. Nicks worked to persuade Cortright that distributing responsibilities and operational programs among the NASA field centers would be “a prudent management decision.” NASA needed balance among its research centers. To ensure NASA’s future in space, headquarters must assign to all its centers challenging endeavors that would stimulate the development of “new and varied capabilities.”¹⁶

Spaceflight Revolution

Cortright was persuaded and gave Nicks permission to approach Floyd Thompson.* This Nicks did on 2 January 1963, during a Senior Council meeting of the Office of Space Sciences at Cape Canaveral. Nicks asked Thompson whether Langley “would be willing to study the feasibility of undertaking a lunar photography experiment,” and Thompson answered cautiously that he would ask his staff to consider the idea.¹⁷

The historical record does not tell us much about Thompson’s personal thoughts regarding taking on Lunar Orbiter. But one can infer from the evidence that Thompson had mixed feelings, not unlike those he experienced about supporting the STG. The Langley director would not only give Nicks a less than straightforward answer to his question but also would think about the offer long and hard before committing the center. Thompson invited several trusted staff members to share their feelings about assuming responsibility for the project. For instance, he went to Clint Brown, by then one of his three assistant directors for research, and asked him what he thought Langley should do. Brown told him emphatically that he did not think Langley should take on Lunar Orbiter. An automated deep-space project would be difficult to manage successfully. The Lunar Orbiter would be completely different from the Ranger and Surveyor spacecraft and being a new design, would no doubt encounter many unforeseen problems. Even if it were done to everyone’s satisfaction—and the proposed schedule for the first launches sounded extremely tight—Langley would probably handicap its functional research divisions to give the project all the support that it would need. Projects devoured resources. Langley staff had learned this firsthand from its experience with the STG. Most of the work for Lunar Orbiter would rest in the management of contracts at industrial plants and in the direction of launch and mission control operations at Cape Canaveral and Pasadena. Brown, for one, did not want to be involved.¹⁸

But Thompson decided, in what Brown now calls his director’s “greater wisdom,” that the center should accept the job of managing the project. Some researchers in Brown’s own division had been proposing a Langley-directed photographic mission to the moon for some time, and Thompson, too, was excited by the prospect.¹⁹ Furthermore, the revamped Lunar Orbiter was not going to be a space mission seeking general scientific knowledge about the moon. It was going to be a mission directly in support of Apollo, and this meant that engineering requirements would be primary. Langley staff preferred that practical orientation; their past work often resembled projects on a smaller scale. Whether the “greater wisdom” stemmed from Thompson’s own powers of judgment is still not certain. Some informed Langley veterans, notably Brown, feel that Thompson must

* Edgar Cortright and Oran Nicks would come to have more than a passing familiarity with the capabilities of Langley Research Center. In 1968, NASA would name Cortright to succeed Thompson as the center’s director. Shortly thereafter, Cortright named Nicks as his deputy director. Both men then stayed at the center into the mid-1970s.

To Behold the Moon: The Lunar Orbiter Project

have also received some strongly stated directive from NASA headquarters that said Langley had no choice but to take on the project.

Whatever was the case in the beginning, Langley management soon welcomed Lunar Orbiter. It was a chance to prove that they could manage a major undertaking. Floyd Thompson personally oversaw many aspects of the project and for more than four years did whatever he could to make sure that Langley's functional divisions supported it fully. Through most of this period, he would meet every Wednesday morning with the top people in the project office to hear about the progress of their work and offer his own ideas. As one staff member recalls, "I enjoyed these meetings thoroughly. [Thompson was] the most outstanding guy I've ever met, a tremendously smart man who knew what to do and when to do it."²⁰

Throughout the early months of 1963, Langley worked with its counterparts at NASA headquarters to establish a solid and cooperative working relationship for Lunar Orbiter. The center began to draw up preliminary specifications for a lightweight orbiter spacecraft and for the vehicle that would launch it (already thought to be the Atlas-Agena D). While Langley personnel were busy with that, TRW's Space Technologies Laboratories (STL) of Redondo Beach, California, was conducting a parallel study of a lunar orbiter photographic spacecraft under contract to NASA headquarters. Representatives from STL reported on this work at meetings at Langley on 25 February and 5 March 1963. Langley researchers reviewed the contractor's assessment and found that STL's estimates of the chances for mission success closely matched their own. If five missions were attempted, the probability of achieving one success was 93 percent. The probability of achieving two was 81 percent. Both studies confirmed that a lunar orbiter system using existing hardware would be able to photograph a landed Surveyor and would thus be able to verify the conditions of that possible Apollo landing site. The independent findings concluded that the Lunar Orbiter project could be done successfully and should be done quickly because its contribution to the Apollo program would be great.²¹

Project Management

With the exception of its involvement in the X-series research airplane programs at Muroc, Langley had not managed a major project during the period of the NACA. As a NASA center, Langley would have to learn to manage projects that involved contractors, subcontractors, other NASA facilities, and headquarters—a tall order for an organization used to doing all its work in-house with little outside interference. Only three major projects were assigned to Langley in the early 1960s: Scout, in 1960; Fire, in 1961; and Lunar Orbiter, in 1963. Project Mercury and Little Joe, although heavily supported by Langley, had been managed by the independent STG, and Project Echo, although managed by Langley for a while, eventually was given to Goddard to oversee.

Spaceflight Revolution

To prepare for Lunar Orbiter in early 1963, Langley management reviewed what the center had done to initiate the already operating Scout and Fire projects. It also tried to learn from JPL about inaugurating paperwork for, and subsequent management of, Projects Ranger and Surveyor. After these reviews, Langley felt ready to prepare the formal documents required by NASA for the start-up of the project.²²

As Langley prepared for Lunar Orbiter, NASA's policies and procedures for project management were changing. In October 1962, spurred on by its new top man, James Webb, the agency had begun to implement a series of structural changes in its overall organization. These were designed to improve relations between headquarters and the field centers, an area of fundamental concern. Instead of managing the field centers through the Office of Programs, as had been the case, NASA was moving them under the command of the headquarters program directors. For Langley, this meant direct lines of communication with the OART and the OSSA. By the end of 1963, a new organizational framework was in place that allowed for more effective management of NASA projects.

In early March 1963, as part of Webb's reform, NASA headquarters issued an updated version of General Management Instruction 4-1-1. This revised document established formal guidelines for the planning and management of a project. Every project was supposed to pass through four preliminary stages: (1) Project Initiation, (2) Project Approval, (3) Project Implementation, and (4) Organization for Project Management.²³ Each step required the submission of a formal document for headquarters' approval.

From the beginning, everyone involved with Lunar Orbiter realized that it had to be a fast-track project. In order to help Apollo, everything about it had to be initiated quickly and without too much concern about the letter of the law in the written procedures. Consequently, although no step was to be taken without first securing approval for the preceding step, Langley initiated the paperwork for all four project stages at the same time. This same no-time-to-lose attitude ruled the schedule for project development. All aspects had to be developed concurrently. Launch facilities had to be planned at the same time that the design of the spacecraft started. The photographic, micrometeoroid, and selenodetic experiments had to be prepared even before the mission operations plan was complete. Everything proceeded in parallel: the development of the spacecraft, the mission design, the operational plan and preparation of ground equipment, the creation of computer programs, as well as a testing plan. About this parallel development, Donald H. Ward, a key member of Langley's Lunar Orbiter project team, remarked, "Sometimes this causes undoing some mistakes, but it gets to the end product a lot faster than a serial operation where you design the spacecraft and then the facilities to support it."²⁴ Using the all-at-once approach, Langley put Lunar Orbiter in orbit around the moon only 27 months after signing with the contractor.

To Behold the Moon: The Lunar Orbiter Project



Israel Taback (left) and Clifford H. Nelson (right), head of LOPO, ponder the intricacies of the spacecraft design.

L-64-7909

On 11 September 1963, Director Floyd Thompson formally established the Lunar Orbiter Project Office (LOPO) at Langley, a lean organization of just a few people who had been at work on Lunar Orbiter since May. Thompson named Clifford H. Nelson as the project manager. An NACA veteran and head of the Measurements Research Branch of IRD, Nelson was an extremely bright engineer. He had served as project engineer on several flight research programs, and Thompson believed that he showed great promise as a technical manager. He worked well with others, and Thompson knew that skill in interpersonal relations would be essential in managing Lunar Orbiter because so much of the work would entail interacting with contractors.

To help Nelson, Thompson originally reassigned eight people to LOPO: engineers Israel Taback, Robert Girouard, William I. Watson, Gerald Brewer, John B. Graham, Edmund A. Brummer, financial accountant Robert Fairburn, and secretary Anna Plott. This group was far smaller than the staff of 100 originally estimated for this office. The most important technical minds brought in to participate came from either IRD or from the Applied Materials and Physics Division, which was the old PARD. Taback was the experienced and sage head of the Navigation and Guidance Branch of IRD; Brummer, an expert in telemetry, also came from IRD; and two

Spaceflight Revolution

new Langley men, Graham and Watson, were brought in to look over the integration of mission operations and spacecraft assembly for the project. A little later IRD's talented Bill Boyer also joined the group as flight operations manager, as did the outstanding mission analyst Norman L. Crabill, who had just finished working on Project Echo. All four of the NACA veterans were serving as branch heads at the time of their assignment to LOPO. This is significant given that individuals at that level of authority and experience are often too entrenched and concerned about further career development to take a temporary assignment on a high-risk project. The LOPO staff set up an office in a room in the large 16-Foot Transonic Tunnel building in the Langley West Area.

When writing the Request for Proposals, Nelson, Taback, and the others involved could only afford the time necessary to prepare a brief document, merely a few pages long, that sketched out some of the detailed requirements. As Israel Taback remembers, even before the project office was established, he and a few fellow members of what would become LOPO had already talked extensively with the potential contractors. Taback explains, "Our idea was that they would be coming back to us [with details]. So it wasn't like we were going out cold, with a brand new program."²⁵

Langley did need to provide one critical detail in the request: the means for stabilizing the spacecraft in lunar orbit. Taback recalls that an "enormous difference" arose between Langley and NASA headquarters over this issue. The argument was about whether the Request for Proposals should require that the contractors produce a rotating satellite known as a "spinner." The staff of the OSSA preferred a spinner based on STL's previous study of Lunar Orbiter requirements. However, Langley's Lunar Orbiter staff doubted the wisdom of specifying the means of stabilization in the Request for Proposals. They wished to keep the door open to other, perhaps better, ways of stabilizing the vehicle for photography.

The goal of the project, after all, was to take the best possible high-resolution pictures of the moon's surface. To do that, NASA needed to create the best possible orbital platform for the spacecraft's sophisticated camera equipment, whatever that turned out to be. From their preliminary analysis and conversations about mission requirements, Taback, Nelson, and others in LOPO felt that taking these pictures from a three-axis (yaw, pitch, and roll), attitude-stabilized device would be easier than taking them from a spinner. A spinner would cause distortions of the image because of the rotation of the vehicle. Langley's John F. Newcomb of the Aero-Space Mechanics Division (and eventual member of LOPO) had calculated that this distortion would destroy the resolution and thus seriously compromise the overall quality of the pictures. This was a compromise that the people at Langley quickly decided they could not live with. Thus, for sound technical reasons, Langley insisted that the design of the orbiter be kept an open matter and not be specified in the Request for Proposals. Even if Langley's engineers were wrong and a properly designed spinner would

To Behold the Moon: The Lunar Orbiter Project

be most effective, the sensible approach was to entertain all the ideas the aerospace industry could come up with before choosing a design.²⁶

For several weeks in the summer of 1963, headquarters tried to resist the Langley position. Preliminary studies by both STL for the OSSA and by Bell Communications (BellComm) for the Office of Manned Space Flight indicated that a rotating spacecraft using a spin-scan film camera similar to the one developed by the Rand Corporation in 1958 for an air force satellite reconnaissance system ("spy in the sky") would work well for Lunar Orbiter. Such a spinner would be less complicated and less costly than the three-axis-stabilized spacecraft preferred by Langley.²⁷

But Langley staff would not cave in on an issue so fundamental to the project's success. Eventually Newell, Cortright, Nicks, and Scherer in the OSSA offered a compromise that Langley could accept: the Request for Proposals could state that "if bidders could offer approaches which differed from the established specifications but which would result in substantial gains in the probability of mission success, reliability, schedule, and economy," then NASA most certainly invited them to submit those alternatives. The request would also emphasize that NASA wanted a lunar orbiter that was built from as much off-the-shelf hardware as possible. The development of many new technological systems would require time that Langley did not have.²⁸

Langley and headquarters had other differences of opinion about the request. For example, a serious problem arose over the nature of the contract. Langley's chief procurement officer, Sherwood Butler, took the conservative position that a traditional cost-plus-a-fixed-fee contract would be best in a project in which several unknown development problems were bound to arise. With this kind of contract, NASA would pay the contractor for all actual costs plus a sum of money fixed by the contract negotiations as a reasonable profit.

NASA headquarters, on the other hand, felt that some attractive financial incentives should be built into the contract. Although unusual up to this point in NASA history, headquarters believed that an incentives contract would be best for Lunar Orbiter. Such a contract would assure that the contractor would do everything possible to solve all the problems encountered and make sure that the project worked. The incentives could be written up in such a way that if, for instance, the contractor lost money on any one Lunar Orbiter mission, the loss could be recouped with a handsome profit on the other missions. The efficacy of a cost-plus-incentives contract rested in the solid premise that nothing motivated a contractor more than making money. NASA headquarters apparently understood this better than Langley's procurement officer who wanted to keep tight fiscal control over the project and did not want to do the hairsplitting that often came with evaluating whether the incentive clauses had been met.²⁹

On the matter of incentives, Langley's LOPO engineers sided against their own man and with NASA headquarters. They, too, thought that

Spaceflight Revolution

incentives were the best way to do business with a contractor—as well as the best way to illustrate the urgency that NASA attached to Lunar Orbiter.³⁰ The only thing that bothered them was the vagueness of the incentives being discussed. When Director Floyd Thompson understood that his engineers really wanted to take the side of headquarters on this issue, he quickly concurred. He insisted only on three things: the incentives had to be based on clear stipulations tied to cost, delivery, and performance, with penalties for deadline overruns; the contract had to be fully negotiated and signed before Langley started working with any contractor (in other words, work could not start under a letter of intent); and all bidding had to be competitive. Thompson worried that the OSSA might be biased in favor of STL as the prime contractor because of STL's prior study of the requirements of lunar orbiter systems.³¹

In mid-August 1963, with these problems worked out with headquarters, Langley finalized the Request for Proposals and associated Statement of Work, which outlined specifications, and delivered both to Captain Lee R. Scherer, Lunar Orbiter's program manager at NASA headquarters, for presentation to Ed Cortright and his deputy Oran Nicks. The documents stated explicitly that the main mission of Lunar Orbiter was "the acquisition of photographic data of high and medium resolution for selection of suitable Apollo and Surveyor landing sites." The request set out detailed criteria for such things as identifying "cones" (planar features at right angles to a flat surface), "slopes" (circular areas inclined with respect to the plane perpendicular to local gravity), and other subtle aspects of the lunar surface. Obtaining information about the size and shape of the moon and about the lunar gravitational field was deemed less important. By omitting a detailed description of the secondary objectives in the request, Langley made clear that "under no circumstances" could anything "be allowed to dilute the major photo-reconnaissance mission."³² The urgency of the national commitment to a manned lunar landing mission was the force driving Lunar Orbiter. Langley wanted no confusion on that point.

The Source Evaluation Board

Cliff Nelson and LOPO moved quickly in September 1963 to create a Source Evaluation Board that would possess the technical expertise and good judgment to help NASA choose wisely from among the industrial firms bidding for Lunar Orbiter. A large board of reviewers (comprising more than 80 evaluators and consultants from NASA centers and other aerospace organizations) was divided into groups to evaluate the technical feasibility, cost, contract management concepts, business operations, and other critical aspects of the proposals. One group, the so-called Scientists' Panel, judged the suitability of the proposed spacecraft for providing valuable information to the scientific community after the photographic

To Behold the Moon: The Lunar Orbiter Project

mission had been completed. Langley's two representatives on the Scientists' Panel were Clint Brown and Dr. Samuel Katzoff, an extremely insightful engineering analyst, 27-year Langley veteran, and assistant chief of the Applied Materials and Physics Division.

Although the opinions of all the knowledgeable outsiders were taken seriously, Langley intended to make the decision.³³ Chairing the Source Evaluation Board was Eugene Draley, one of Floyd Thompson's assistant directors. When the board finished interviewing all the bidders, hearing their oral presentations, and tallying the results of its scoring of the proposals (a possible 70 points for technical merit and 30 points for business management), it was to present a formal recommendation to Thompson. He in turn would pass on the findings with comments to Homer Newell's office in Washington.

Five major aerospace firms submitted proposals for the Lunar Orbiter contract. Three were California firms: STL in Redondo Beach, Lockheed Missiles and Space Company of Sunnyvale, and Hughes Aircraft Company of Los Angeles. The Martin Company of Baltimore and the Boeing Company of Seattle were the other two bidders.³⁴

Three of the five proposals were excellent. Hughes had been developing an ingenious spin-stabilization system for geosynchronous communication satellites, which helped the company to submit an impressive proposal for a rotating vehicle. With Hughes's record in spacecraft design and fabrication, the Source Evaluation Board gave Hughes serious consideration. STL also submitted a fine proposal for a spin-stabilized rotator. This came as no surprise, of course, given STL's prior work for Surveyor as well as its prior contractor studies on lunar orbiter systems for NASA headquarters.

The third outstanding proposal—entitled "ACLOPS" (Agena-Class Lunar Orbiter Project)—was Boeing's. The well-known airplane manufacturer had not been among the companies originally invited to bid on Lunar Orbiter and was not recognized as the most logical of contenders. However, Boeing recently had successfully completed the Bomarc missile program and was anxious to become involved with the civilian space program, especially now that the DOD was canceling Dyna-Soar, an air force project for the development of an experimental X-20 aerospace plane. This cancellation released several highly qualified U.S. Air Force personnel, who were still working at Boeing, to support a new Boeing undertaking in space. Company representatives had visited Langley to discuss Lunar Orbiter, and Langley engineers had been so excited by what they had heard that they had pestered Thompson to persuade Seamans to extend an invitation to Boeing to join the bidding. The proposals from Martin, a newcomer in the business of automated space probes, and Lockheed, a company with years of experience handling the Agena space vehicle for the air force, were also quite satisfactory. In the opinion of the Source Evaluation Board, however, the proposals from Martin and Lockheed were not as strong as those from Boeing and Hughes.

Spaceflight Revolution

The LOPO staff and the Langley representatives decided early in the evaluation that they wanted Boeing to be selected as the contractor; on behalf of the technical review team, Israel Taback had made this preference known both in private conversations with, and formal presentations to, the Source Evaluation Board. Boeing was Langley's choice because it proposed a three-axis-stabilized spacecraft rather than a spinner. For attitude reference in orbit, the spacecraft would use an optical sensor similar to the one that was being planned for use on the Mariner C spacecraft, which fixed on the star Canopus.

An attitude-stabilized orbiter eliminated the need for a focal-length spin camera. This type of photographic system, first conceived by Merton E. Davies of the Rand Corporation in 1958, could compensate for the distortions caused by a rotating spacecraft but would require extensive development. In the Boeing proposal, Lunar Orbiter would carry a photo subsystem designed by Eastman Kodak and used on DOD spy satellites.³⁵ This subsystem worked automatically and with the precision of a Swiss watch. It employed two lenses that took pictures simultaneously on a roll of 70-millimeter aerial film. If one lens failed, the other still worked. One lens had a focal length of 610 millimeters (24 inches) and could take pictures from an altitude of 46 kilometers (28.5 miles) with a high resolution for limited-area coverage of approximately 1 meter. The other, which had a focal length of about 80 millimeters (3 inches), could take pictures with a medium resolution of approximately 8 meters for wide coverage of the lunar surface. The film would be developed on board the spacecraft using the proven Eastman Kodak "Bimat" method. The film would be in contact with a web containing a single-solution dry processing chemical, which eliminated the need to use wet chemicals. Developed automatically and wound onto a storage spool, the processed film could then be "read out" and transmitted by the spacecraft's communications subsystem to receiving stations of JPL's worldwide Deep Space Network, which was developed for communication with spacefaring vehicles destined for the moon and beyond.³⁶

How Boeing had the good sense to propose an attitude-stabilized platform based on the Eastman Kodak camera, rather than to propose a rotator with a yet-to-be developed camera is not totally clear. Langley engineers had conversed with representatives of all the interested bidders, so Boeing's people might possibly have picked up on Langley's concerns about the quality of photographs from spinners. The other bidders, especially STL and Hughes, with their expertise in spin-stabilized spacecraft, might also have picked up on those concerns but were too confident in the type of rotationally stabilized system they had been working on to change course in midstream.

Furthermore, Boeing had been working closely with RCA, which for a time was also thinking about submitting a proposal for Lunar Orbiter. RCA's idea was a lightweight (200-kilogram), three-axis, attitude-stabilized, and camera-bearing payload that could be injected into lunar orbit as part of a Ranger-type probe. A lunar orbiter study group, chaired by Lee Scherer

To Behold the Moon: The Lunar Orbiter Project

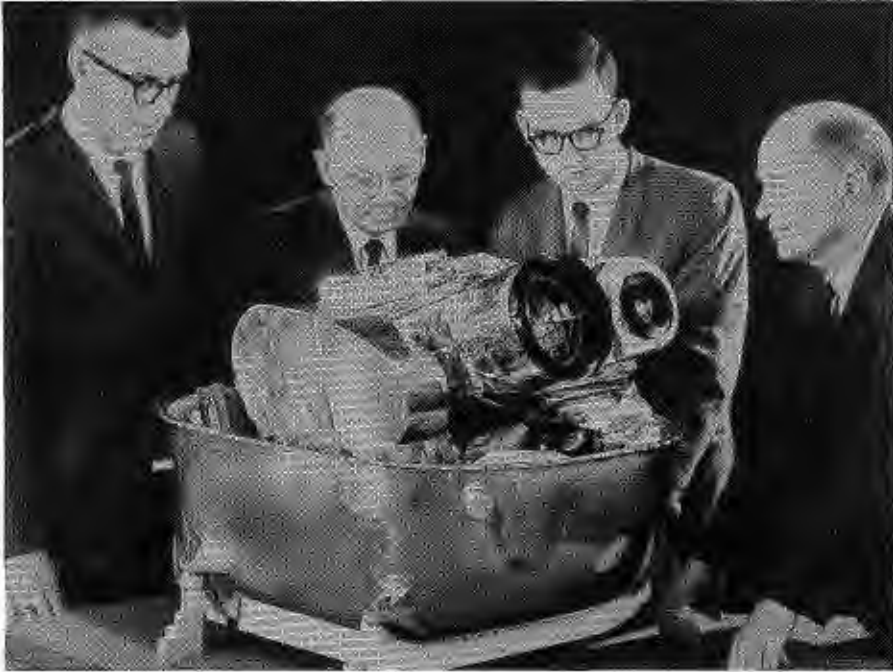

L-67-5655

Lunar Orbiter was essentially a flying camera. The payload structure was built around a pressurized shell holding Eastman Kodak's dual-imaging photographic system, which used a camera with wide-angle and telephoto lenses that could simultaneously take two kinds of pictures on the same film.

at NASA headquarters, had evaluated RCA's approach in October 1962, however, and found it lacking. It was too expensive (\$20.4 million for flying only three spacecraft), and its proposed vidicon television unit could not cover the lunar surface either in the detail or the wide panoramas NASA wanted.³⁷

Boeing knew all about this rejected RCA approach. After talking to Langley's engineers, the company shrewdly decided to stay with an attitude-stabilized orbiter but to dump the use of the inadequate vidicon television. Boeing replaced the television system with an instrument with a proven track record in planetary reconnaissance photography: the Eastman Kodak spy camera.³⁸

On 20 December 1963, two weeks after the Source Evaluation Board made its formal recommendation to Administrator James Webb in Washington, NASA announced that it would be negotiating with Boeing as prime contractor for the Lunar Orbiter project. Along with the excellence of its proposed spacecraft design and Kodak camera, NASA singled out the strength of Boeing's commitment to the project and its corporate capabilities to

Spaceflight Revolution

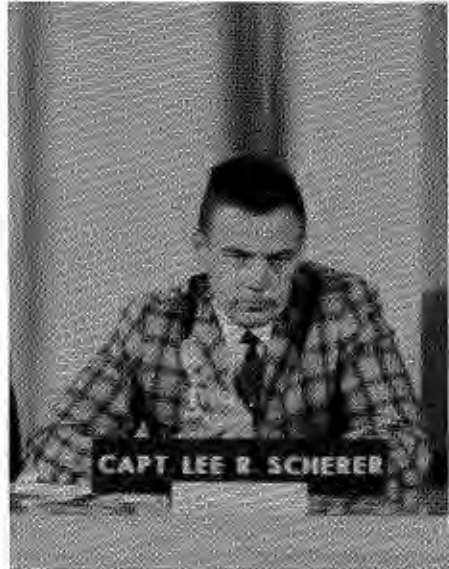

Capt. Lee R. Scherer served as Lunar Orbiter's program manager at NASA headquarters.

L-66-6301

complete it on schedule without relying on many subcontractors. Still, the choice was a bit ironic. Only 14 months earlier, the Scherer study group had rejected RCA's approach in favor of a study of a spin-stabilized spacecraft proposed by STL. Now Boeing had outmaneuvered its competition by proposing a spacecraft that incorporated essential features of the rejected RCA concept and almost none from the STL's previously accepted one.

Boeing won the contract even though it asked for considerably more money than any of the other bidders. The lowest bid, from Hughes, was \$41,495,339, less than half of Boeing's \$83,562,199, a figure that would quickly rise when the work started. Not surprisingly, NASA faced some congressional criticism and had to defend its choice. The agency justified its selection by referring confidently to what Boeing alone proposed to do to ensure protection of Lunar Orbiter's photographic film from the hazards of solar radiation.³⁹

This was a technical detail that deeply concerned LOPO. Experiments conducted by Boeing and by Dr. Trutz Foelsche, a Langley scientist in the Space Mechanics (formerly Theoretical Mechanics) Division who specialized in the study of space radiation effects, suggested that even small doses of radiation from solar flares could fog ordinary high-speed photographic film. This would be true especially in the case of an instrumented probe like Lunar Orbiter, which had thin exterior vehicular shielding. Even if the thickness of the shielding around the film was increased tenfold (from 1 g/cm² to 10 g/cm²), Foelsche judged that high-speed film would not make it through a significant solar-particle event without serious damage.⁴⁰ Thus,

To Behold the Moon: The Lunar Orbiter Project



L-64-4141

Representatives of NASA Langley and Boeing signed the Lunar Orbiter contract on 16 April 1964 and sent it to NASA headquarters for final review. Three weeks later, on 7 May, Administrator James E. Webb approved the \$80-million incentives contract to build five Lunar Orbiter spacecraft.

something extraordinary had to be done to protect the high-speed film. A better solution was not to use high-speed film at all.

As NASA explained successfully to its critics, the other bidders for the Lunar Orbiter contract relied on high-speed film and faster shutter speeds for their on-board photographic subsystems. Only Boeing did not. When delegates from STL, Hughes, Martin, and Lockheed were asked at a bidders' briefing in November 1963 about what would happen to their film if a solar event occurred during an orbiter mission, they all had to admit that the film would be damaged seriously. Only Boeing could claim otherwise. Even with minimal shielding, the more insensitive, low-speed film used by the Kodak camera would not be fogged by high-energy radiation, not even if the spacecraft moved through the Van Allen radiation belts.⁴¹ This, indeed, proved to be the case. During the third mission of Lunar Orbiter in February 1967, a solar flare with a high amount of optical activity did occur, but the film passed through it unspoiled.⁴²

Negotiations with Boeing did not take long. Formal negotiations began on 17 March 1964, and ended just four days later. On 7 May Administrator Webb signed the document that made Lunar Orbiter an official NASA

Spaceflight Revolution

commitment. Hopes were high. But in the cynical months of 1964, with Ranger's setbacks still making headlines and critics still faulting NASA for failing to match Soviet achievements in space, everyone doubted whether Lunar Orbiter would be ready for its first scheduled flight to the moon in just two years.

Nelson's Team

Large projects are run by only a handful of people. Four or five key individuals delegate jobs and responsibilities to others. This was certainly true for Lunar Orbiter. From start to finish, Langley's LOPO remained a small organization; its original nucleus of 9 staff members never grew any larger than 50 professionals. Langley management knew that keeping LOPO's staff small meant fewer people in need of positions when the project ended. If all the positions were built into a large project office, many careers would be out on a limb; a much safer organizational method was for a small project office to draw people from other research and technical divisions to assist the project as needed.⁴³

In the case of Lunar Orbiter, four men ran the project: Cliff Nelson, the project manager; Israel Taback, who was in charge of all activities leading to the production and testing of the spacecraft; Bill Boyer, who was responsible for planning and integrating launch and flight operations; and James V. Martin, the assistant project manager. Nelson had accepted the assignment with Thompson's assurance that he would be given wide latitude in choosing the men and women he wanted to work with him in the project office. As a result, virtually all of his top people were handpicked.

The one significant exception was his chief assistant, Jim Martin. In September 1964, the Langley assistant director responsible for the project office, Gene Draley, brought in Martin to help Nelson cope with some of the stickier details of Lunar Orbiter's management. A senior manager in charge of Republic Aviation's space systems requirements, Martin had a tremendous ability for anticipating business management problems and plenty of experience taking care of them. Furthermore, he was a well-organized and skillful executive who could make schedules, set due dates, and closely track the progress of the contractors and subcontractors. This "paper" management of a major project was troublesome for Cliff Nelson, a quiet people-oriented person. Draley knew about taskmaster Martin from Republic's involvement in Project Fire and was hopeful that Martin's acerbity and business-mindedness would complement Nelson's good-heartedness and greater technical depth, especially in dealings with contractors.

Because Cliff Nelson and Jim Martin were so entirely opposite in personality, they did occasionally clash, which caused a few internal problems in LOPO. On the whole, however, the alliance worked quite well, although it was forced by Langley management. Nelson generally oversaw the whole endeavor and made sure that everybody worked together as a team. For

To Behold the Moon: The Lunar Orbiter Project



L-66-6301

In contrast to the quiet, people-oriented LOPO director Cliff Nelson (left), James “Big Jim” Martin (right) breathed fire when it came to getting consistent top-grade performance from the NASA contractors.

the monitoring of the day-to-day progress of the project’s many operations, Nelson relied on the dynamic Martin. For example, when problems arose with the motion-compensation apparatus for the Kodak camera, Martin went to the contractor’s plant to assess the situation and decided that its management was not placing enough emphasis on following a schedule. Martin acted tough, pounded on the table, and made the contractor put workable schedules together quickly. When gentler persuasion was called for or subtler interpersonal relationships were involved, Nelson was the person for the job. Martin, who was technically competent but not as technically talented as Nelson, also deferred to the project manager when a decision required particularly complex engineering analysis. Thus, the two men worked together for the overall betterment of Lunar Orbiter.⁴⁴

Placing an excellent person with just the right specialization in just the right job was one of the most important elements behind the success of Lunar Orbiter, and for this eminently sensible approach to project management, Cliff Nelson and Floyd Thompson deserve the lion’s share of credit. Both men cultivated a management style that emphasized direct dealings with people and often ignored formal organizational channels. Both stressed the importance of teamwork and would not tolerate any individual, however talented, willfully undermining the esprit de corps. Before filling any position in the project office, Nelson gave the selection much thought. He questioned whether the people under consideration were compatible with others already in his project organization. He wanted to know whether candidates were goal-oriented—willing to do whatever was

Spaceflight Revolution

necessary (working overtime or traveling) to complete the project.⁴⁵ Because Langley possessed so many employees who had been working at the center for many years, the track record of most people was either well known or easy to ascertain. Given the outstanding performance of Lunar Orbiter and the testimonies about an exceptionally healthy work environment in the project office, Nelson did an excellent job predicting who would make a productive member of the project team.⁴⁶

Considering Langley's historic emphasis on fundamental applied aeronautical research, it might seem surprising that Langley scientists and engineers did not try to hide inside the dark return passage of a wind tunnel rather than be diverted into a spaceflight project like Lunar Orbiter. As has been discussed, some researchers at Langley (and agencywide) objected to and resisted involvement with project work. The Surveyor project at JPL had suffered from staff members' reluctance to leave their own specialties to work on a space project. However, by the early 1960s the enthusiasm for spaceflight ran so rampant that it was not hard to staff a space project office. All the individuals who joined LOPO at Langley came enthusiastically; otherwise Cliff Nelson would not have had them. Israel Taback, who had been running the Communications and Control Branch of IRD, remembers having become distressed with the thickening of what he calls "the paper forest": the preparation of five-year plans, ten-year plans, and other lengthy documents needed to justify NASA's budget requests. The work he had been doing with airplanes and aerospace vehicles was interesting (he had just finished providing much of the flight instrumentation for the X-15 program), but not so interesting that he wanted to turn down Cliff Nelson's offer to join Lunar Orbiter. "The project was brand new and sounded much more exciting than what I had been doing," Taback remembers. It appealed to him also because of its high visibility both inside and outside the center. Everyone had to recognize the importance of a project directly related to the national goal of landing a man on the moon.⁴⁷

Norman L. Crabill, the head of LOPO's mission design team, also decided to join the project. On a Friday afternoon, he had received the word that one person from his branch of the Applied Materials and Physics Division would have to be named by the following Monday as a transfer to LOPO; as branch head, Crabill himself would have to make the choice. That weekend he asked himself, "What's your own future, Crabill? This is space. If you don't step up to this, what's your next chance. You've already decided not to go with the guys to Houston." He immediately knew who to transfer, "It was me." That was how he "got into the space business." And in his opinion, it was "the best thing" that he ever did.⁴⁸

The Boeing Team

Cliff Nelson's office had the good sense to realize that monitoring the prime contractor did not entail doing Boeing's work for Boeing. Nelson

To Behold the Moon: The Lunar Orbiter Project

approached the management of Lunar Orbiter more practically: the contractor was “to perform the work at hand while the field center retained responsibility for overseeing his progress and assuring that the job was done according to the terms of the contract.” For Lunar Orbiter, this philosophy meant specifically that the project office would have to keep “a continuing watch on the progress of the various components, subsystems, and the whole spacecraft system during the different phases of designing, fabricating and testing them.”⁴⁹ Frequent meetings would take place between Nelson and his staff and their counterparts at Boeing to discuss all critical matters, but Langley would not assign all the jobs, solve all the problems, or micromanage every detail of the contractor’s work.

This philosophy sat well with Robert J. Helberg, head of Boeing’s Lunar Orbiter team. Helberg had recently finished directing the company’s work on the Bomarc missile, making him a natural choice for manager of Boeing’s next space venture. The Swedish-born Helberg was absolutely straightforward, and all his people respected him immensely—as would everyone in LOPO. He and fellow Swede Cliff Nelson got along famously. Their relaxed relationship set the tone for interaction between Langley and Boeing. Ideas and concerns passed freely back and forth between the project offices. Nelson and his people “never had to fear the contractor was just telling [them] a lie to make money,” and Helberg and his tightly knit, 220-member Lunar Orbiter team never had to complain about uncaring, paper-shuffling bureaucrats who were mainly interested in dotting all the i’s and crossing all the t’s and making sure that nothing illegal was done that could bother government auditors and put their necks in a wringer.⁵⁰

The Langley/NASA headquarters relationship was also harmonious and effective. This was in sharp contrast to the relationship between JPL and headquarters during the Surveyor project. Initially, JPL had tried to monitor the Surveyor contractor, Hughes, with only a small staff that provided little on-site technical direction; however, because of unclear objectives, the open-ended nature of the project (such basic things as which experiment packages would be included on the Surveyor spacecraft were uncertain), and a too highly diffused project organization within Hughes, JPL’s “laissez-faire” approach to project management did not work. As the problems snowballed, Cortright found it necessary to intervene and compelled JPL to assign a regiment of on-site supervisors to watch over every detail of the work being done by Hughes. Thus, as one analyst of Surveyor’s management has observed, “the responsibility for overall spacecraft development was gradually retrieved from Hughes by JPL, thereby altering significantly the respective roles of the field center and the spacecraft systems contractors.”⁵¹

Nothing so unfortunate happened during Lunar Orbiter, partly because NASA had learned from the false steps and outright mistakes made in the management of Surveyor. For example, NASA now knew that before implementing a project, everyone involved must take part in extensive

Spaceflight Revolution

preliminary discussions. These conversations ensured that the project's goals were certain and each party's responsibilities clear. Each office should expect maximum cooperation and minimal unnecessary interference from the others. Before Lunar Orbiter was under way, this excellent groundwork had been laid.

As has been suggested by a 1972 study done by the National Academy of Public Administration, the Lunar Orbiter project can serve as a model of the ideal relationship between a prime contractor, a project office, a field center, a program office, and headquarters. From start to finish nearly everything important about the interrelationship worked out superbly in Lunar Orbiter. According to LOPO's Israel Taback, "Everyone worked together harmoniously as a team whether they were government, from headquarters or from Langley, or from Boeing." No one tried to take advantage of rank or to exert any undue authority because of an official title or organizational affiliation.⁵² That is not to say that problems never occurred in the management of Lunar Orbiter. In any large and complex technological project involving several parties, some conflicts are bound to arise. The key to project success lies in how differences are resolved.

The "Concentrated" versus the "Distributed" Mission

The most fundamental issue in the premission planning for Lunar Orbiter was how the moon was to be photographed. Would the photography be "concentrated" on a predetermined single target, or would it be "distributed" over several selected targets across the moon's surface? On the answer to this basic question depended the successful integration of the entire mission plan for Lunar Orbiter.

For Lunar Orbiter, as with any other spaceflight program, mission planning involved the establishment of a complicated sequence of events: When should the spacecraft be launched? When does the launch window open and close? On what trajectory should the spacecraft arrive in lunar orbit? How long will it take the spacecraft to get to the moon? How and when should orbital "injection" take place? How and when should the spacecraft get to its target(s), and at what altitude above the lunar surface should it take the pictures? Where does the spacecraft need to be relative to the sun for taking optimal pictures of the lunar surface? Answering these questions also meant that NASA's mission planners had to define the lunar orbits, determine how accurately those orbits could be navigated, and know the fuel requirements. The complete mission profile had to be ready months before launch. And before the critical details of the profile could be made ready, NASA had to select the targeted areas on the lunar surface and decide how many of them were to be photographed during the flight of a single orbiter.⁵³

Originally NASA's plan was to conduct a concentrated mission. The Lunar Orbiter would go up and target a single site of limited dimensions.

To Behold the Moon: The Lunar Orbiter Project



Top NASA officials listen to a LOPO briefing at Langley in December 1966. Sitting to the far right with his hand on his chin is Floyd Thompson. To the left sits Dr. George Mueller, NASA associate administrator for Manned Space Flight. On the wall is a diagram of the sites selected for the "concentrated mission." The chart below illustrates the primary area of photographic interest.

L-66-10290

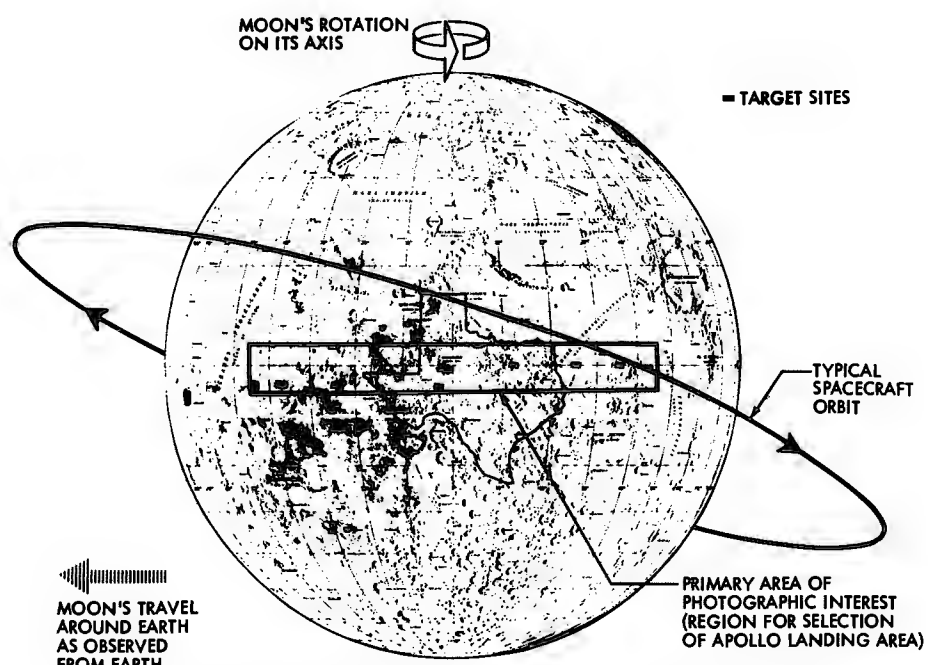

LUNAR SURFACE PHOTOGRAPHIC COVERAGE

Spaceflight Revolution

The country's leading astrogeologists would help in the site selection by identifying the smoothest, most attractive possibilities for a manned lunar landing. The U.S. Geological Survey had drawn huge, detailed maps of the lunar surface from the best available telescopic observations. With these maps, NASA would select one site as the prime target for each of the five Lunar Orbiter missions. During a mission, the spacecraft would travel into orbit and move over the target at the "perilune," or lowest point in the orbit (approximately 50 kilometers [31.1 miles] above the surface); then it would start taking pictures. Successive orbits would be close together longitudinally, and the Lunar Orbiter's camera would resume photographing the surface each time it passed over the site. The high-resolution lens would take a 1-meter-resolution picture of a small area (4×16 kilometers) while at exactly the same time, the medium-resolution lens would take an 8-meter-resolution picture of a wider area (32×37 kilometers). The high-resolution lens would photograph at such a rapid interval that the pictures would just barely overlap. The wide-angle pictures, taken by the medium-resolution lens, would have a conveniently wide overlap. All the camera exposures would take place in 24 hours, thus minimizing the threat to the film from a solar flare. The camera's capacity of roughly 200 photographic frames would be devoted to one location. The result would be one area shot in adjacent, overlapping strips. By putting the strips together, NASA had a picture of a central 1-meter-resolution area that was surrounded by a broader 8-meter-resolution area—in other words, it would be one large, rich stereoscopic picture of a choice lunar landing site. NASA would learn much about that one ideal place, and the Apollo program would be well served.⁵⁴

The plan sounded fine to everyone—at least in the beginning. Langley's Request for Proposals had specified the concentrated mission, and Boeing had submitted the winning proposal based on that mission plan. Moreover, intensive, short-term photography like that called for in a concentrated mission was exactly what Eastman Kodak's high-resolution camera system had been designed for. The camera was a derivative of a spy satellite photo system created specifically for earth reconnaissance missions specified by the DOD.*

* In the top-secret DOD system, the camera with the film inside apparently would reenter the atmosphere inside a heat-shielded package that parachuted down, was hooked, and was physically retrieved in midair (if all went as planned) by a specially equipped U.S. Air Force C-119 cargo airplane. It was obviously a very unsatisfactory system, but in the days before advanced electronic systems, it was the best high-resolution satellite reconnaissance system that modern technology could provide. Few NASA people were ever privy to many of the details of how the "black box" actually worked, because they did not have "the need to know." However, they figured that it had been designed, as one LOPO engineer has described in much oversimplified layman's terms, "so when a commander said, 'we've got the target,' bop, take your snapshots, zap, zap, zap, get it down from orbit, retrieve it and bring it home, rush it off to Kodak, and get your pictures." (Norman Crabill interview with author, Hampton, Va., 28 August 1991.)

To Behold the Moon: The Lunar Orbiter Project

As LOPO's mission planners gave the plan more thought, however, they realized that the concentrated mission approach was flawed. Norman Crabill, Langley's head of mission integration for Lunar Orbiter, remembers the question he began to ask himself, "What happens if only one of these missions is going to work? This was in the era of Ranger failures and Surveyor slippage. When you shoot something, you had only a twenty percent probability that it was going to work. It was that bad." On that premise, NASA planned to fly five Lunar Orbiters, hoping that one would operate as it should. "Suppose we go up there and shoot all we [have] on one site, and it turns out to be no good?" fretted Crabill, and others began to worry as well. What if that site was not as smooth as it appeared on the U.S. Geological Survey maps, or a gravitational anomaly or orbital perturbation was present, making that particular area of the moon unsafe for a lunar landing? And what if that Lunar Orbiter turned out to be the only one to work? What then?⁵⁵

In late 1964, over the course of several weeks, LOPO became more convinced that it should not be putting all its eggs in one basket. "We developed the philosophy that we really didn't want to do the concentrated mission; what we really wanted to do was what we called the 'distributed mission,'" recalls Crabill. The advantage of the distributed mission was that it would enable NASA to inspect several choice targets in the Apollo landing zone with only one spacecraft.⁵⁶

In early 1965, Norm Crabill and Tom Young of the LOPO mission integration team traveled to the office of the U.S. Geological Survey in Flagstaff, Arizona. There, the Langley engineers consulted with U.S. government astrogeologists John F. McCauley, Lawrence Rowan, and Harold Masursky. Jack McCauley was Flagstaff's top man at the time, but he assigned Larry Rowan, "a young and upcoming guy, very reasonable and very knowledgeable," the job of heading the Flagstaff review of the Lunar Orbiter site selection problem. "We sat down with Rowan at a table with these big lunar charts," and Rowan politely reminded the Langley duo that "the dark areas on the moon were the smoothest." Rowan then pointed to the darkest places across the entire face of the moon.⁵⁷

Rowan identified 10 good targets. When Crabill and Young made orbital calculations, they became excited. In a few moments, they had realized that they wanted to do the distributed mission. Rowan and his colleagues in Flagstaff also became excited about the prospects. This was undoubtedly the way to catch as many landing sites as possible. The entire Apollo zone of interest was $\pm 45^\circ$ longitude and $\pm 5^\circ$ latitude, along the equatorial region of the facing, or near side of the moon. Within that zone, the area that could be photographed via a concentrated mission was small. A single Lunar Orbiter that could photograph 10 sites of that size all within that region would be much more effective. If the data showed that a site chosen by the astrogeologists was not suitable, NASA would have excellent photographic coverage of nine other prime sites. In summary, the distributed mode would

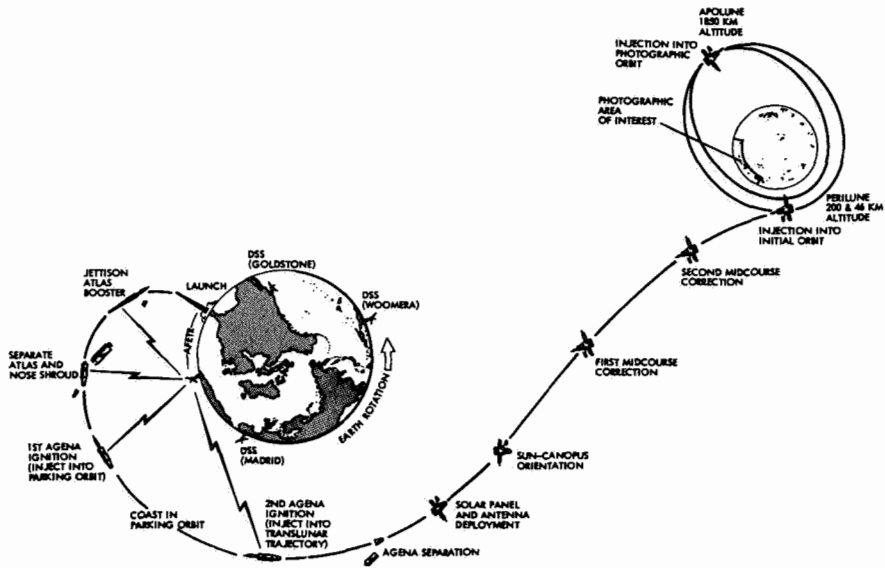

TYPICAL FLIGHT SEQUENCE OF EVENTS

L-66-5819

Lunar Orbiter's "Typical Flight Sequence of Events" turned out to be quite typical indeed, as all five spacecraft performed exactly as planned.

give NASA the flexibility to ensure that Lunar Orbiter would provide the landing site information needed by Apollo even if only one Lunar Orbiter mission proved successful.

But there was one big hitch: Eastman Kodak's photo system was not designed for the distributed mission. It was designed for the concentrated mission in which all the photography would involve just one site and be loaded, shot, and developed in 24 hours. If Lunar Orbiter must photograph 10 sites, a mission would last at least two weeks. The film system was designed to sustain operations for only a day or two; if the mission lasted longer than that, the Bimat film would stick together, the exposed parts of it would dry out, the film would get stuck in the loops, and the photographic mission would be completely ruined.

When Boeing first heard that NASA had changed its mind and now wanted to do the distributed mission, Helberg and his men balked. According to LOPO's Norman Crabill, Boeing's representatives said, "Look, we understand you want to do this. But, wait. The system was designed, tested, used, and proven in the concentrated mission mode. You can't change it

To Behold the Moon: The Lunar Orbiter Project

now because it wasn't designed to have the Bimat film in contact for long periods of time. In two weeks' time, some of the Bimat is just going to go, pfft! It's just going to fail!" Boeing understood the good sense of the distributed mission, but as the prime contractor, the company faced a classic technological dilemma. The customer, NASA, wanted to use the system to do something it was not designed to do. This could possibly cause a disastrous failure. Boeing had no recourse but to advise the customer that what it wanted to do could endanger the entire mission.⁵⁸

The Langley engineers wanted to know whether Boeing could solve the film problem. "We don't know for sure," the Boeing staff replied, "and we don't have the time to find out." NASA suggested that Boeing conduct tests to obtain quantitative data that would define the limits of the film system. Boeing's response was "That's not in the contract."⁵⁹ The legal documents specified that the Lunar Orbiter should have the capacity to conduct the concentrated mission. If NASA now wanted to change the requirements for developing the Orbiter, then a new contract would have to be negotiated. A stalemate resulted on this issue and lasted until early 1965. The first launch was only a year away.

If LOPO hoped to persuade Boeing to accept the idea of changing a basic mission requirement, it had to know the difference in reliability between the distributed and concentrated missions. If analysis showed that the distributed mission would be far less reliable, then even LOPO might want to reconsider and proceed with the concentrated mission. Crabill gave the job of obtaining this information to Tom Young, a young researcher from the Applied Materials and Physics Division. Crabill had specifically requested that Young be reassigned to LOPO mission integration because, in his opinion, Young was "the brightest guy [he] knew." On the day Young had reported to work with LOPO, Crabill had given him "a big pile of stuff to read," thinking he would be busy and, as Crabill puts it, "out of my hair for quite a while." But two days later, Young returned, having already made his way through all the material. When given the job of the comparative mission reliability analysis, Young went to Boeing in Seattle. In less than two weeks, he found what he needed to know and figured out the percentages: the reliability for the concentrated mission was an unspectacular 60 percent, but for the distributed mission it was only slightly worse, 58 percent. "It was an insignificant difference," Crabill thought when he heard Young's numbers, especially because nobody then really knew how to do that type of analysis. "We didn't gag on the fact that it was pretty low anyway, but we really wanted to do this distributed mission." The Langley researchers decided that the distributed mission was a sensible choice, if the Kodak system could be made to last for the extra time and if Boeing could be persuaded to go along with the mission change.⁶⁰

LOPO hoped that Young's analysis would prove to Boeing that no essential difference in reliability existed between the two types of missions, but Boeing continued to insist that the concentrated mission was the legal

Spaceflight Revolution

requirement, not the distributed mission. The dispute was a classic case of implementing a project before even the customer was completely sure of what that project should accomplish. In such a situation, the only sensible thing to do was to be flexible.

The problem for Boeing, of course, was that such flexibility might cost the company its financial incentives. If a Lunar Orbiter mission failed, the company worried that it would not be paid the bonus money promised in the contract. Helberg and Nelson discussed this issue in private conversations. Floyd Thompson participated in many of these talks and even visited Seattle to try to facilitate an agreement. In the end, Langley convinced Helberg that the change from a concentrated to a distributed mission would not impact Boeing's incentives. If a mission failed because of the change, LOPO promised that it would assume the responsibility. Boeing would have done its best according to the government request and instructions—and for that they would not be penalized.⁶¹

The missions, however, would not fail. NASA and Boeing would handle the technical problems involving the camera by testing the system to ascertain the definite limits of its reliable operation. From Kodak, the government and the prime contractor obtained hard data regarding the length of time the film could remain set in one place before the curls or bends in the film around the loops became permanent and the torque required to advance the film exceeded the capability of the motor. From these tests, Boeing and LOPO established a set of mission “rules” that had to be followed precisely. For example, to keep the system working, Lunar Orbiter mission controllers at JPL had to advance the film one frame every eight hours. The rules even required that film sometimes be advanced without opening the door of the camera lens. Mission controllers called these nonexposure shots their “film-set frames” and the schedule of photographs their “film budget.”⁶²

As a result of the film rules, the distributed mission turned out to be a much busier operation than a concentrated mission would have been. Each time a photograph was taken, including film-set frames, the spacecraft had to be maneuvered. Each maneuver required a command from mission control. LOPO staff worried about the ability of the spacecraft to execute so many maneuvers over such a prolonged period. They feared something would go wrong during a maneuver that would cause them to lose control of the spacecraft. *Lunar Orbiter I*, however, flawlessly executed an astounding number of commands, and LOPO staff were able to control spacecraft attitude during all 374 maneuvers.⁶³

Ultimately, the trust between Langley and Boeing allowed each to take the risk of changing to a distributed mission. Boeing trusted Langley to assume responsibility if the mission failed, and Langley trusted Boeing to put its best effort into making the revised plan a success. Had either not fulfilled its promise to the other, Lunar Orbiter would not have achieved its outstanding record.

To Behold the Moon: The Lunar Orbiter Project

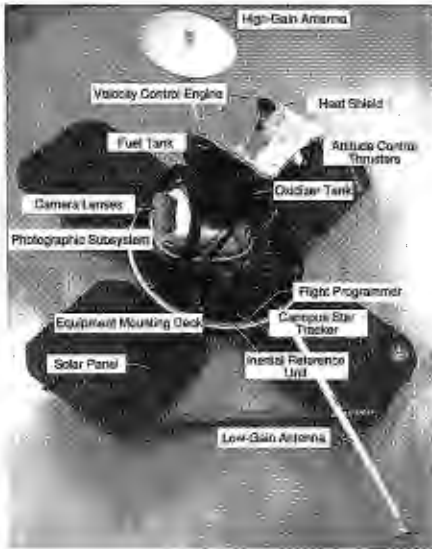

Simple as this diagram of Lunar Orbiter (left) may look, no spacecraft in NASA history operated more successfully than Lunar Orbiter. Below, Lunar Orbiter I goes through a final inspection in the NASA Hanger S clean room at Kennedy Space Center prior to launch on 10 August 1966. The spacecraft was mounted on a three-axis test stand with its solar panels deployed and high-gain dish antenna extended from the side.

P36982



L-66-6387

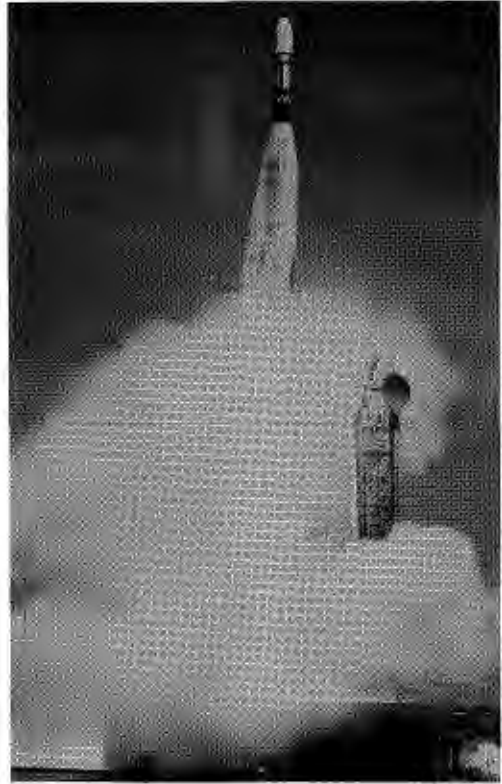

L-66-6381

Lunar Orbiter I lifts off from Cape Kennedy on 10 August 1966. With a payload weighing only 860 pounds, the spacecraft was light enough to fly on an Atlas-Agena instead of the more expensive Atlas-Centaur.

“The Picture of the Century”

The switch to the distributed mission was not the only instance during the Lunar Orbiter mission when contract specifications were jettisoned to pursue a promising idea. Boeing engineers realized that the Lunar Orbiter project presented a unique opportunity for photographing the earth. When the LOPO staff heard this idea, they were all for it, but Helberg and Boeing management rejected the plan. Turning the spacecraft around so that its camera could catch a quick view of the earth tangential to the moon’s surface entailed technical difficulties, including the danger that, once the spacecraft’s orientation was changed, mission controllers could lose command of the spacecraft. Despite the risk, NASA urged Boeing to incorporate the maneuver in the mission plan for *Lunar Orbiter I*. Helberg refused.⁶⁴

In some projects, that might have been the end of the matter. People would have been forced to forget the idea and to live within the circumscribed world of what had been legally agreed upon. Langley, however, was not about to give up on this exciting opportunity. Cliff Nelson,

To Behold the Moon: The Lunar Orbiter Project



L-66-7999

With “the picture of the century” proudly displayed before them, key members of the LOPO team report the success of Lunar Orbiter I at a press conference in August 1966. Left to right are Oran W. Nicks, director of Lunar and Planetary Programs at NASA headquarters; Floyd Thompson; Cliff Nelson; and Isadore G. Recant, the Langley scientist in charge of data handling for the spacecraft. At the podium is the U.S. Geological Survey’s Dr. Larry Rowan, the young geologist who helped LOPO identify the most promising landing sites.

Floyd Thompson, and Lee Scherer went to mission control at JPL to talk to Helberg and at last convinced him that he was being too cautious—that “the picture was worth the risk.” If any mishap occurred with the spacecraft during the maneuver, NASA again promised that Boeing would still receive compensation and part of its incentive for taking the risk. The enthusiasm of his own staff for the undertaking also influenced Helberg in his final decision to take the picture.⁶⁵

On 23 August 1966 just as *Lunar Orbiter I* was about to pass behind the moon, mission controllers executed the necessary maneuvers to point the camera away from the lunar surface and toward the earth. The result was the world’s first view of the earth from space. It was called “the picture of the century” and “the greatest shot taken since the invention of photography.”*

* The unprecedented photo also provided the first oblique perspectives of the lunar surface. All other photographs taken during the first mission were shot from a position perpendicular to the surface and thus, did not depict the moon in three dimensions. In subsequent missions, NASA made sure to include this sort of oblique photography. Following the first mission, Boeing prepared a booklet entitled *Lunar Orbiter I—Photography* (NASA Langley, 1968), which gave a detailed technical description of the earth-moon photographs; see especially pp. 64–71.

Spaceflight Revolution

Not even the color photos of the earth taken during the Apollo missions superseded the impact of this first image of our planet as a little island of life floating in the black and infinite sea of space.⁶⁶

Mission More Than Accomplished

Lunar Orbiter defied all the probability studies. All five missions worked extraordinarily well, and with the minor exception of a short delay in the launch of *Lunar Orbiter I*—the Eastman Kodak camera was not ready—all the missions were on schedule. The launches were three months apart with the first taking place in August 1966 and the last in August 1967. This virtually perfect flight record was a remarkable achievement, especially considering that Langley had never before managed any sort of flight program into deep space.

Lunar Orbiter accomplished what it was designed to do, and more. Its camera took 1654 photographs. More than half of these (840) were of the proposed Apollo landing sites. *Lunar Orbiters I, II, and III* took these site pictures from low-flight altitudes, thereby providing detailed coverage of 22 select areas along the equatorial region of the near side of the moon. One of the eight sites scrutinized by *Lunar Orbiters II and III* was a very smooth area in the Sea of Tranquility. A few years later, in July 1969, Apollo 11 commander Neil Armstrong would navigate the lunar module *Eagle* to a landing on this site.⁶⁷

By the end of the third Lunar Orbiter mission, all the photographs needed to cover the Apollo landing sites had been taken. NASA was then free to redesign the last two missions, move away from the pressing engineering objective imposed by Apollo, and go on to explore other regions of the moon for the benefit of science. Eight hundred and eight of the remaining 814 pictures returned by *Lunar Orbiters IV and V* focused on the rest of the near side, the polar regions, and the mysterious far side of the moon. These were not the first photographs of the “dark side”; a Soviet space probe, *Zond III*, had taken pictures of it during a fly-by into a solar orbit a year earlier, in July 1965. But the Lunar Orbiter photos were higher quality than the Russian pictures and illuminated some lunar landscapes that had never before been seen by the human eye. The six remaining photos were of the spectacular look back at the distant earth. By the time all the photos were taken, about 99 percent of the moon’s surface had been covered.

When each Lunar Orbiter completed its photographic mission, the spacecraft continued its flight to gather clues to the nature of the lunar gravitational environment. NASA found these clues valuable in the planning of the Apollo flights. Telemetry data clearly indicated that the moon’s gravitational pull was not uniform. The slight dips in the path of the Lunar Orbiters as they passed over certain areas of the moon’s surface were caused by gravitational perturbations, which in turn were caused by the mascons.

To Behold the Moon: The Lunar Orbiter Project

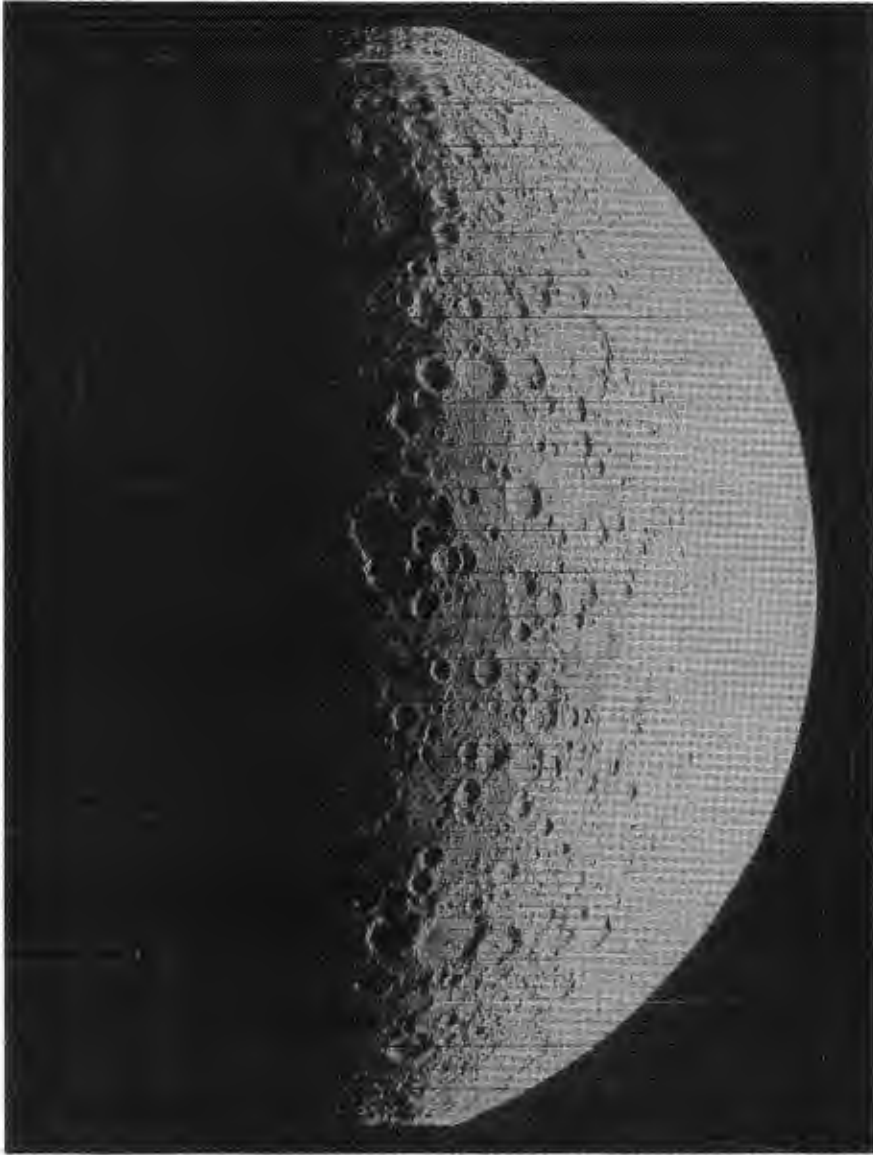

L-67-6702

Lunar Orbiter V provided the first wide-angle view of the moon's mysterious "dark side."

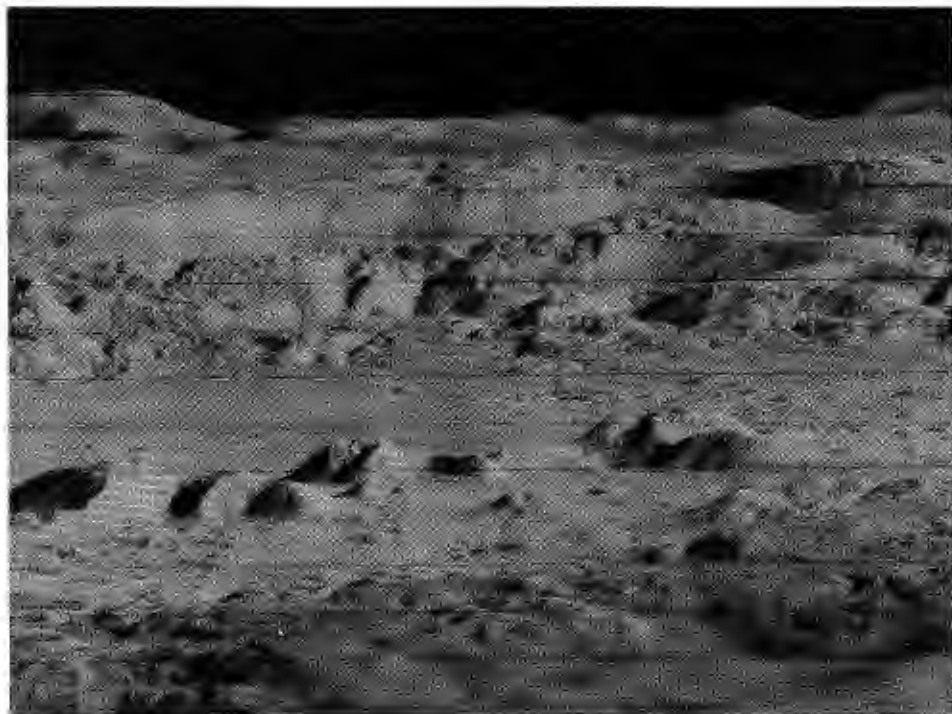

L-66-9788

One of the most spectacular mosaics produced by Lunar Orbiter II was this close-up of the enormous crater Copernicus with its 300-meter-high (984.3 feet) mountains rising from the crater floor. On the horizon are the Carpathian mountains with the 920-meter-high (3018.4 feet) Guy-Lussac Promontory.

The extended missions of the Lunar Orbiters also helped to confirm that radiation levels near the moon were quite low and posed no danger to astronauts unless a major solar flare occurred while they were exposed on the lunar surface. A few months after each Lunar Orbiter mission, NASA deliberately crashed the spacecraft into the lunar surface to study lunar impacts and their seismic consequences. Destroying the spacecraft before it deteriorated and mission controllers had lost command of it ensured that it would not wander into the path of some future mission.⁶⁸

Whether the Apollo landings could have been made successfully without the photographs from Lunar Orbiter is a difficult question to answer. Without the photos, the manned landings could certainly still have been attempted. In addition to the photographic maps drawn from telescopic observation, engineers could use some good pictures taken from Ranger and Surveyor to guide them. However, the detailed photographic coverage of 22 possible landing sites definitely made NASA's final selection of ideal sites much easier and the pinpointing of landing spots possible.

To Behold the Moon: The Lunar Orbiter Project

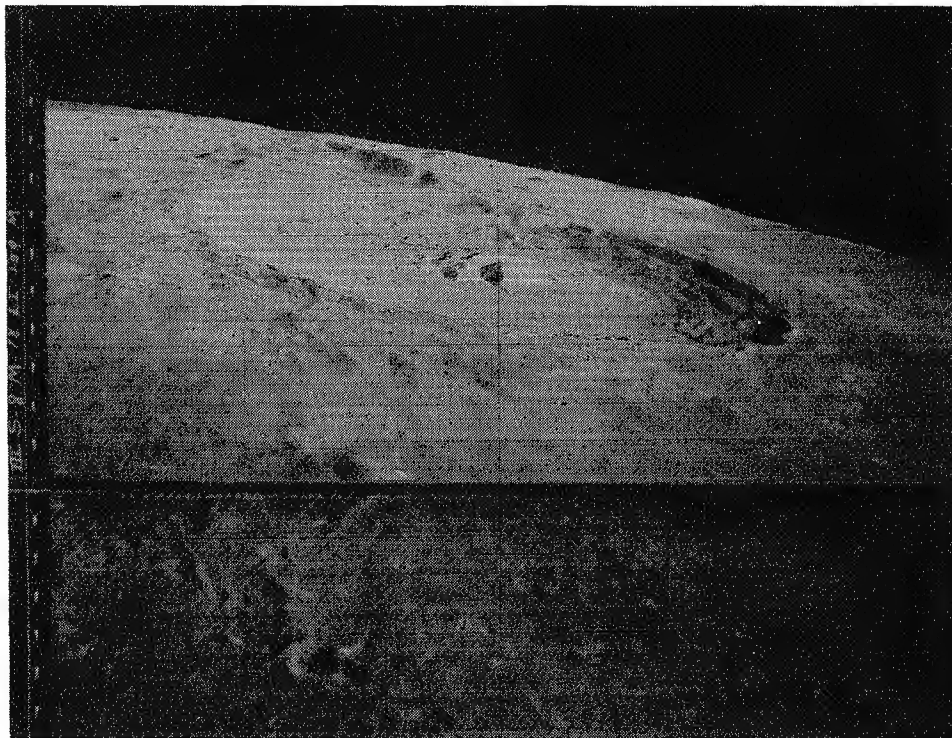

L-67-4023

In August 1967, Lunar Orbiter V photographed the 90-kilometer-wide (55.9 miles) Tycho crater, one of the brightest craters seen from earth. A young impact crater, Tycho reveals its central peak, rough floor, and precipitous walls.

Furthermore, Lunar Orbiter also contributed important photometric information that proved vital to the Apollo program. Photometry involves the science of measuring the intensity of light. Lunar Orbiter planners had to decide where to position the camera to have the best light for taking the high-resolution photographs. When we take pictures on earth, we normally want to have the sun behind us so it is shining directly on the target. But a photo taken of the lunar surface in these same circumstances produces a peculiar photometric function: the moon looks flat. Even minor topographical features are indistinguishable because of the intensity of the reflecting sunlight from the micrometeorite-filled lunar surface. The engineers in LOPO had to determine the best position for photographing the moon. After studying the problem (Taback, Crabill, and Young led the attack on this problem), LOPO's answer was that the sun should indeed be behind the spacecraft, but photographs should be taken when the sun was only 15 degrees above the horizon.⁶⁹

Long before it was time for the first Apollo launch, LOPO's handling of the lunar photometric function was common knowledge throughout NASA

and the aerospace industry. The BellComm scientists and engineers who reviewed Apollo planning quickly realized that astronauts approaching the moon to make a landing needed, like Lunar Orbiter, to be in the best position for viewing the moon's topography. Although a computer program would pinpoint the Apollo landing site, the computer's choice might not be suitable. If that was the case, astronauts would have to rely on their own eyes to choose a spot. If the sun was in the wrong position, they would not make out craters and boulders, the surface would appear deceptively flat, and the choice might be disastrous. Apollo 11 commander Neil Armstrong did not like the spot picked by the computer for the *Eagle* landing. Because NASA had planned for him to be in the best viewing position relative to the sun, Armstrong could see that the place was "littered with boulders the size of Volkswagens." So he flew on. He had to go another 1500 meters before he saw a spot where he could set the lunar module down safely.⁷⁰

NASA might have considered the special photometric functions involved in viewing the moon during Apollo missions without Lunar Orbiter, but the experience of the Lunar Orbiter missions took the guesswork out of the calculations. NASA knew that its astronauts would be able to see what they needed to see to avoid surface hazards. This is a little-known but important contribution from Lunar Orbiter.

Secrets of Success

In the early 1970s Erasmus H. Kloman, a senior research associate with the National Academy of Public Administration, completed an extensive comparative investigation of NASA's handling of its Surveyor and Lunar Orbiter projects. After a lengthy review, NASA published a shortened and distilled version of Kloman's larger study as *Unmanned Space Project Management: Surveyor and Lunar Orbiter*. The result—even in the expurgated version, with all names of responsible individuals left out—was a penetrating study in "sharp contrasts" that should be required reading for every project manager in business, industry, or government.

Based on his analysis of Surveyor and Lunar Orbiter, Kloman concluded that project management has no secrets of success. The key elements are enthusiasm for the project, a clear understanding of the project's objective, and supportive and flexible interpersonal and interoffice relationships. The history of Surveyor and Lunar Orbiter, Kloman wrote, "serves primarily as a confirmation of old truths about the so-called basic principles of management rather than a revelation of new ones." Kloman writes that Langley achieved Lunar Orbiter's objectives by "playing it by the book." By this, Kloman meant that Langley applied those simple precepts of good management; he did not mean that success was achieved through a thoughtless and strict formula for success. Kloman understood that Langley's project engineers broke many rules and often improvised as they went along. Enthusiasm, understanding, support, and flexibility

To Behold the Moon: The Lunar Orbiter Project

allowed project staff to adapt the mission to new information, ideas, or circumstances. "Whereas the Surveyor lessons include many illustrations of how 'not to' set out on a project or how to correct for early misdirections," Kloman argued, "Lunar Orbiter shows how good sound precepts and directions from the beginning can keep a project on track."⁷¹

Lunar Orbiter, however, owes much of its success to Surveyor. LOPO staff were able to learn from the mistakes made in the Surveyor project. NASA headquarters was responsible for some of these mistakes. The complexity of Surveyor was underestimated, unrealistic manpower and financial ceilings were imposed, an "unreasonably open-ended combination of scientific experiments for the payload" was insisted upon for too long, too many changes in the scope and objectives of the project were made, and the project was tied to the unreliable Centaur launch vehicle.⁷² NASA headquarters corrected these mistakes. In addition, Langley representatives learned from JPL's mistakes and problems. They talked at great length to JPL staff in Pasadena about Surveyor both before and after accepting the responsibility for Lunar Orbiter. From these conversations, Langley acquired a great deal of knowledge about the design and management of an unmanned space mission. JPL scientists and engineers even conducted an informal "space school" that helped to educate several members of LOPO and Boeing's team about key details of space mission design and operations.

The interpersonal skills of the individuals responsible for Lunar Orbiter, however, appear to have been the essential key to success. These skills centered more on the ability to work with other people than they did on what one might presume to be the more critical and esoteric managerial, conceptual, and technical abilities. In Kloman's words, "individual personal qualities and management capabilities can at times be a determining influence in overall project performance."⁷³ Compatibility among individual managers, Nelson and Helberg, and the ability of those managers to stimulate good working relationships between people proved a winning combination for Lunar Orbiter.

Norman Crabill made these comments about Lunar Orbiter's management: "We had some people who weren't afraid to use their own judgment instead of relying on rules. These people could think and find the essence of a problem, either by discovering the solution themselves or energizing the troops to come up with an alternative which would work. They were absolute naturals at that job."⁷⁴

Lunar Orbiter was a pathfinder for Apollo, and it was an outstanding contribution by Langley Research Center to the early space program. The old NACA aeronautics laboratory proved not only that it could handle a major deep space mission, but also that it could achieve an extraordinary record of success that matched or surpassed anything yet tried by NASA. When the project ended and LOPO members went back into functional research divisions, Langley possessed a pool of experienced individuals who were ready, if the time came, to plan and manage yet another major

Spaceflight Revolution

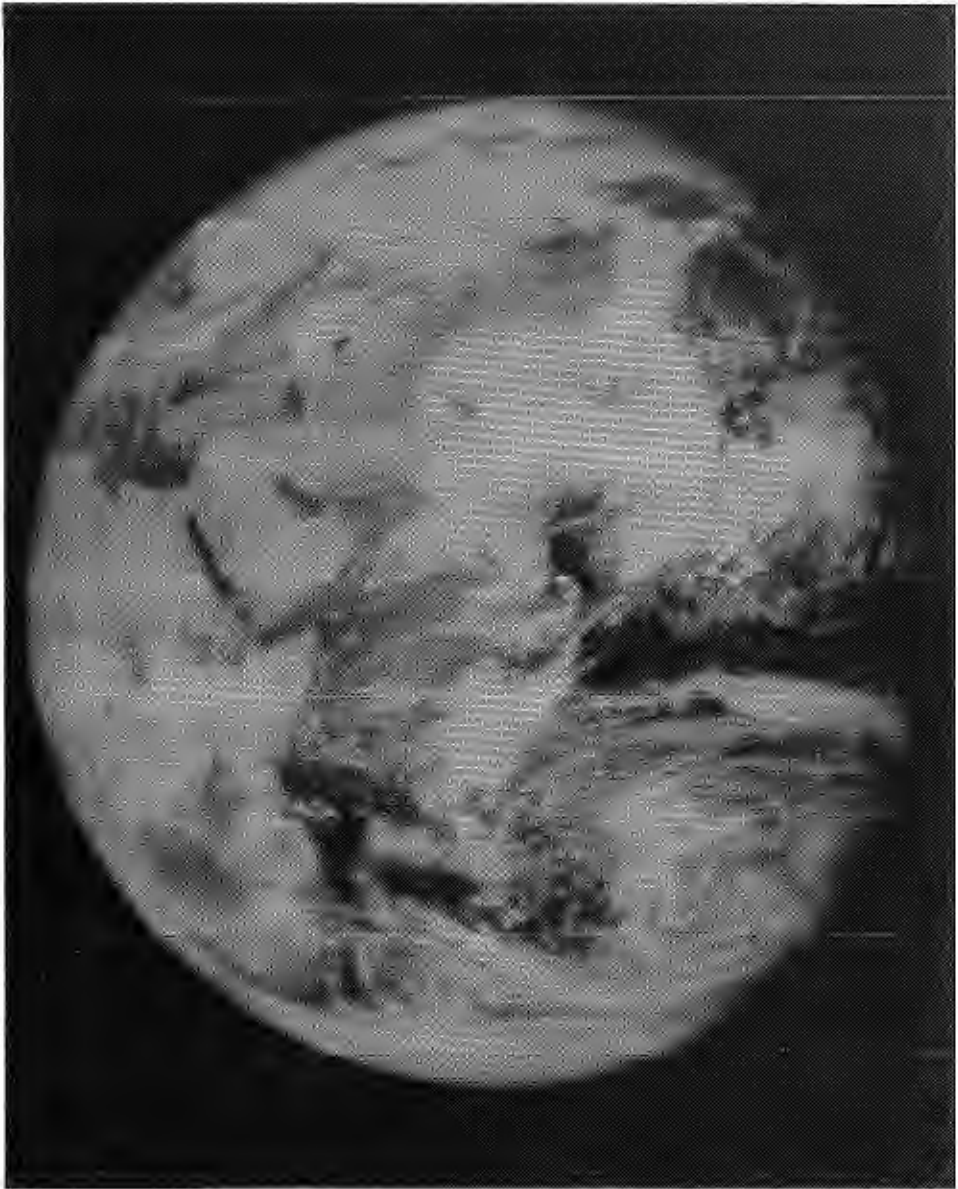

L-67-6777

Although most people have come to associate the first picture of the "Whole Earth" with the Apollo program, Lunar Orbiter V actually captured this awesome view of the home planet. When this picture was taken on 8 August 1967, the spacecraft was about 5860 kilometers (3641.2 miles) above the moon in near polar orbit, so that the lunar surface is not seen. Clearly visible on the left side of the globe is the eastern half of Africa and the entire Arabian peninsula.

To Behold the Moon: The Lunar Orbiter Project

project. That opportunity came quickly in the late 1960s with the inception of Viking, a much more complicated and challenging project designed to send unmanned reconnaissance orbiters and landing probes to Mars. When Viking was approved, NASA headquarters assigned the project to “those plumbers” at Langley. The old LOPO team formed the nucleus of Langley’s much larger Viking Project Office. With this team, Langley would once again manage a project that would be virtually an unqualified success.

In the Service of Apollo

We were working beyond the state of the art. Nobody had done things like this before.

—E. Barton Geer, associate chief of Langley's Flight Vehicle and Systems Division during the Apollo era and member of the Apollo 204 Review Board

And just as we got to the transonic field, then all of a sudden we opened up with the supersonic field and find out we're flying—militarily anyway—we're flying at speeds of [Mach] 2 and 3. And you just get that pretty well understood and, Holy Smoke, here we are going to the Moon and things like that.

—Floyd L. Thompson, Langley director and chairman of the Apollo 204 Review Board

The crowning moment, as well as the denouement, of the spaceflight revolution came at 4:18 p.m. on Sunday, 20 July 1969, when American astronauts Neil A. Armstrong and Edwin E. "Buzz" Aldrin, Jr., made the first manned lunar landing. The realization of this spectacular moment required the most sudden burst of technological creativity and the largest commitment of resources ever made by any nation in peacetime: an estimated \$24 billion. At its peak the Apollo program employed approximately 400,000 Americans and enlisted the support of over 20,000 industrial firms and universities. As President Kennedy had said in his May 1961 speech, "It will not be one man going to the moon—it will be an entire nation. For all of us must work to put him there."¹

Spaceflight Revolution

“All of us” also meant all the NASA facilities, including the research centers. To be sure, Langley did not serve as the heart of the Apollo program, as it temporarily had for the man-in-space effort before the STG left for Texas. Apollo would not be managed by any of the field centers but by a well-staffed central program office within the Office of Manned Space Flight at NASA headquarters. Of course, the spaceflight centers (the Manned Spacecraft Center in Houston and the Marshall Space Flight Center in Huntsville) were deeply involved. A large, well-funded Apollo program office at Houston was responsible for the budget, schedule, technical design, and production of the three-module Apollo spacecraft; moreover, Houston was the home of Mission Control, the nerve center of NASA’s manned flight operations and the place where all the news reporters went after the launch at Cape Kennedy. At Marshall the von Braun team handled the awesome task of developing the giant Saturn rocket.² These were the two NASA centers where the staff “lived and breathed” Apollo. But neither Langley nor any of the other NASA facilities were left out. Nor could they be. There was too much work to do, too much to learn, and too little time. All NASA centers eventually became heavily involved in the program, and with the exception of Houston and Huntsville, none was more involved than Langley.

Yet, when it came to the Apollo flights themselves and their worldwide publicity, Langley and the other centers were not part of the big show. By the time the Apollo spacecraft sat atop the huge Saturn V at Launch Complex 39A at Kennedy Space Center in July 1969, Langley’s contributions to the Apollo program had already been made and mostly forgotten. That, after all, was the purpose and the predicament of a research center: to lay the groundwork for the technological achievements that others would pursue and for which others would receive the credit. Of course, John Houbolt’s concept of LOR would not be forgotten in the dramatic days of Apollo 11, nor would the flights of the Lunar Orbiter spacecraft. But many other elemental tasks that Langley had done in the service of Apollo would not be remembered: the basic rendezvous and docking studies, the wind-tunnel investigations of the aerodynamic integrity of the Saturn-Apollo launch combination, the work on reentry heating and its potentially fatal effects on the returning Apollo spacecraft, and the simulation training that helped prepare the astronauts not only for the rendezvous and docking in space but also for the actual landing of a manned spacecraft and for astronaut locomotion activities on the moon. From launch to splashdown, there was no aspect of the Apollo mission that scientists, engineers, and technicians at Langley had not helped to develop in one way or another. All this work, however, had been done long before the two Apollo astronauts skillfully maneuvered their lunar module *Eagle* down to the Sea of Tranquility on that historic day in July 1969. All that Langley employees could do on that hot Sunday afternoon in July was sit in front of televisions in their own living rooms, sip cool glasses of lemonade, and applaud with the rest of the country what everyone together had accomplished.

Langley's "Undercover Operation" in Houston

Langley was in a novel situation during the heyday of Apollo. It was the original (and for over 20 years only) NACA center, not to mention the "mother" of many of the other centers (including the Manned Spacecraft Center in Houston), but during the Apollo period, it was relegated to the periphery of NASA's most urgent task. Langley management was not accustomed to being in a marginal position and did not especially like being there.

Members of the local Hampton elite did not like it either. For them and other groups of Langley supporters, the unfortunate situation was the work of conniving politicians who had stolen their precious STG for Texas. The bitterness over this did not fade quickly. On occasion, concern for Langley's displacement led those who knew better to make imprudent remarks. For example, in December 1961 during James Webb's first visit to Langley after becoming NASA administrator, Floyd Thompson, as savvy a person as ever sat in the Langley director's chair, mentioned to Webb that the area's city fathers were wondering exactly what they might expect in terms of new jobs and government contracts as a result of the lunar landing program. Webb responded sharply with a statement that echoed the already famous line from President Kennedy's inaugural address: "The city fathers should be asking not what Apollo can do for them, but what they can do for Apollo."³ Thompson never forgot the sting of this retort and resolved never to give Webb or anyone else reason to question the effort that his own research center was putting into the nation's lunar landing program.

At a meeting of NASA center directors and program office directors held in the so-called control room on the top floor of the NASA headquarters building in early 1962, the question of Langley's contribution to Apollo did come up. For Jim Webb, Apollo was everything, and he wanted assurances from the center directors that they were doing all they could to support the program. Characteristically, Thompson bided his time, waiting while his counterparts at the other NASA centers answered. Then in his deliberate and rather high-pitched midwestern voice, he reported with confidence, "Well, we have a senior man in Houston who keeps track of all that we're doing for it, and is on the spot ready to contact us whenever anyone down there wants us to do anything more."⁴ Such a remark was typical "Tommy" Thompson, and Webb let it pass. He had no idea that such a thing was going on down in Houston or that the Houston organization would even allow it, but he took Thompson at his word.

The Langley center director did have a "senior man" on duty in Houston and only in part so that he could give such smart answers to "Big Jim" Webb. In April 1962, which was a few months before the STG had completed its move to the Southwest, Thompson had dispatched Langley veteran Axel T. Mattson to Houston to serve as research assistant for Manned Spacecraft Projects. The experienced assistant chief of the Full-Scale Research Division,

Spaceflight Revolution

Under the wily direction of Floyd Thompson (left), Langley did everything it could to support Project Apollo and satisfy Administrator Jim Webb (right).



L-61-8539

Mattson was to report his findings to Langley Associate Director Charles Donlan, Thompson's right-hand man.⁵

This was an interesting and unusual development; no other NASA center had such an arrangement, and certainly no other center but Langley could have gotten away with it. Langley had an official explanation of the purpose of this liaison: "to create a mechanism for the timely exchange of information on manned space programs and projects of mutual interest to the Langley Center and the Manned Spacecraft Center and to provide a means for quickly initiating action at Langley as may be required in support of manned spacecraft projects."⁶ In truth, Mattson was acting as a sort of spy—a Langley agent.

"I was running an undercover operation, really, in the technical sense," Mattson remembers, his eyes glimmering. "Here we were a research outfit trying to get involved more directly not only with the Apollo work but with the big Apollo money. It had to do with the way the funding was set up; this was the big controlling factor. For everything Langley was doing in support of the Office of Manned Space Flight and Apollo, it was my assignment to try to get a transfer of funds from Houston, which was getting a lot of money, to Langley, which wasn't." The scheme seems a bit dishonest, but Mattson liked even that aspect of his work. "I was bootlegging material.

I was transferring certain material [from Houston to Langley] without any official authorization." At Langley, Donlan made it clear to Mattson that he should not initiate any work on Apollo for which Langley would have to go running to NASA headquarters for approval and funding. Donlan had told him, "Get it from Houston." That was the real reason Langley had quietly sent Axel Mattson to Houston in April 1962.⁷

At the same time that Americans were becoming enamored with the much exaggerated romance of spies through the first James Bond movies, the free-spirited Mattson fell in love with the intrigues of his espionage work. What made it "so beautiful" for him was the freewheeling nature of the assignment—the freedom to innovate and take some chances. "I didn't fool with protocol or with the big shots. I dealt almost exclusively with the troops in the field who would be honest and open with me." During the working day, he walked from office to office, starting conversations, finding out what was going on, what the problems were, and what Langley might be able to do about them. In the evening, he socialized at the many Houston area cocktail and dinner parties, where he made the important personal contacts that led to office meetings the next day. Besides enjoying convivial relations with his Houston buddies, many of whom he had known at Langley, Mattson also developed close professional and social relationships with many of the NASA contractor representatives. These relationships allowed him to tap a gushing pipeline of Apollo-related technical data.⁸

Through this technological espionage, Mattson was able to obtain valuable information for Langley. Whenever an important new technical matter was being discussed by Houston engineers and industry representatives, Mattson would say, "Gee, I'm awfully interested in that," and those involved would give him all the information they had. "You wouldn't believe it. I went over to their offices the next day and they just gave it to me," all the data, all the technical reports. Conversely, "when they wanted some information, they called me and I'd get it. It would come in my suitcase [from Langley] and I'd go peddle it out." Much of it was raw data, "no formality, nothing to it," a transfer of basic and sometimes even unprocessed information that went unrecorded and was never revealed in any formal documentation. Mattson tried to feel out "when a guy was just having troubles even with calculations. He would be grunting them out and not too sure of the inputs, and I'd bring them back to Langley and have the guys look at it and say, 'How about critiquing it and see if you can change numbers by using the latest test information' and things like that." It was basically "a back-scratching operation." Mattson sometimes went even farther. He admits now that he occasionally would "take a man's calculations right off his desk, make a carbon copy," without the man's knowledge, and put it in his suitcase or in the mail for Langley.⁹

"Let me tell you, my suitcase was full whenever I came back to Langley," not only with papers but also with the slides and films that were being produced at Houston by the carton. Such goodies made Mattson something

Spaceflight Revolution

of a star attraction at Langley department meetings and senior staff get-togethers where he provided some special entertainment. At some point in such proceedings, Mattson remembers, Floyd Thompson would typically pause and joke, “‘Well, I guess we might just as well see if Mattson’s got another film to show us.’ And sure enough, I had another film to show them, or slides, or something.”¹⁰ This was the way Langley kept up with what was going on in Houston and minimized the loss of its STG to Texas.

The other NASA centers, with no direct ties to the STG, could not have placed a man inside the Manned Spacecraft Center; Bob Gilruth and his men would not have tolerated such interlopers. Other centers were left out in the cold. Sometimes those who knew about Langley’s operation tried to tap Mattson for information. “Once in a while,” Mattson remembers, “I would get a call from a guy at Lewis or Ames about something he wanted that was available down in Houston.” For such casual requests, especially if he knew the guy, Mattson usually did his best, but he always kept Langley’s interests foremost in his mind.¹¹

It is rather amazing that the fledgling Houston organization put up with Mattson for as long as it did, which was to the time of the first Apollo flights in 1968. Certainly this would not have been possible without the good graces of Gilruth, who was Floyd Thompson’s good friend. Not everyone at the Manned Spacecraft Center wanted Mattson nosing around. In one meeting not long after the opening of the Houston center, Gilruth was surprised to encounter Mattson and wanted to know what Mattson was doing there. Max Faget answered, “He’s doing nothing as far as I know.” In Mattson’s opinion, Faget did not know. Mattson had stayed as far away from Faget as possible, knowing that the former member of PARD and the STG did not like him or the idea of his walking the halls of the new Houston space center. To the extent that he reported to anyone at Houston, Mattson dealt exclusively with Paul Purser, Gilruth’s deputy director, a longtime friend and Langley veteran. Purser knew what Mattson was up to, generally speaking, but for a short period of time at the beginning had failed to tell his boss anything about it.¹²

Immediately after that first encounter with Mattson, Gilruth called both Purser and Mattson “on the carpet” and demanded the details of the latter’s assignment. Mattson explained his operation and what Thompson and Donlan wanted out of it, and Gilruth grudgingly gave his okay. Whether Gilruth ever brought up the matter of Mattson’s presence in Houston with his former Langley compatriots, Thompson and Donlan, is unknown, but he probably did. Whatever the details of that conversation were, the outcome was that Mattson stayed at Houston off and on for the next several years—despite Max Faget’s objections. In key respects, the assignment was a thankless job, not only professionally but also personally; by Mattson’s own admission, it forced him to neglect his family in Virginia.¹³ But such sacrifices were consistent with the demands of the spaceflight revolution,



L-67-1562

Axel Mattson (far left) flashes the winning smile that made it possible for him, an outsider, to walk the halls of the Manned Spacecraft Center in Houston for months at a time. Robert R. Gilruth (center), the Houston center director grudgingly indulged Mattson's presence. (This photo was actually taken at Langley in 1967 at the foot of the Lunar Landing Research Facility.) To the right of Gilruth is Charles Donlan, Langley's deputy director; to his right is Donald Hewes, the Langley engineer in charge of the Lunar Landing Research Facility. The identity of the man in the NASA overalls is unknown.

and he could always take comfort in the romantic notion that he was an agent in Langley's secret service for Apollo.

The Dynamics of Having an Impact

Only in one or two isolated instances did Mattson's presence in Houston contribute in any dramatic way to Apollo's ultimate success. As discussed in chapter eight, in early 1962, not long after starting his assignment in Houston, Mattson helped win support for John Houbolt's LOR concept in the face of some stubborn opposition at the Texas center. Mattson took Houbolt to every person Mattson thought might be willing to listen, and at the end of the day, at least in Mattson's opinion, the majority of the

Spaceflight Revolution

Houston center engineers supported the LOR concept as the best mission mode for Apollo. A few months later, thanks to some rather keen technical insight regarding the kind of test data NASA might need to assure the design integrity of the returning Apollo command module, Mattson made a less significant but still notable contribution—one that does not appear in the formal NASA record.

The story of that contribution begins three months after Mattson's arrival in Houston—that was when Mattson first got wind of an important full-scale test being planned to measure the impact dynamics of the Apollo command module. The North American Aviation Corporation, which in November 1961 had won the contract to design and build the command and service modules of the Apollo spacecraft, had built a swimming-pool-like facility with a big gantry next to it at the site of its Space Information Systems Division in Downey, California; the purpose of this facility was to acquire data on the pressure and acceleration loads placed on the command module upon impact with the ocean. In late 1962 and early 1963, North American and NASA engineers had already put the command module through preliminary impact tests at the facility and were planning for a final verification test involving the highest and most severe impact drop angle and an Apollo capsule configuration systematically equipped with pressure transducers to measure the impact loads. Inside the capsule the engineers were even installing instrumented mannequins, as in automobile crash tests, to see how astronauts would come through the jolting splash into the water.¹⁴

Mattson became interested in the details of this important test. He made contacts with some of the informed NASA researchers and contractor representatives and started reading up on it. From his knowledge of similar capsule-drop tests carried out in the Back River at Langley on the Mercury capsule, he understood that such a test would prove troublesome. First, a flexible bottom surface on a space capsule, such as the heat-shield system designed for the underneath side of the Apollo command module, would cave in or “oilcan” upon any hard impact. Second, when transducers were put on a boilerplate capsule for the purpose of measuring the loads of the impact pressure, the Langley engineers had found that the pressure would just “wash out” or dissipate, thus making it impossible for them to obtain the needed data. “There would be so much resonance and what-not in the structure,” Mattson explains, “that the damn pressure transducers wouldn't give you that instantaneous spike [i.e., the unusually high and sharply defined maximum or pointed element in the graph]. And that was what busted things up [when one dropped a space capsule from a great height into the water]. It wasn't all that other trash. It was that instant spike.” In the Mercury program the only way that the Langley engineers could get that spike in the recorded data was to work not with boilerplates but with solid models. This solution had worked perfectly.¹⁵

Immediately upon hearing about the proposed Apollo tests, Mattson called Sandy M. Stubbs, a bright young engineer in the Impacting Structures Section of Langley's Structures Research Division. Stubbs was then conducting a test program on the water landing characteristics of various spacecraft models. Mattson asked Stubbs if he was getting any data on a solid model that duplicated the Apollo command module. Stubbs answered that he had no such data; he was not using the Apollo configuration because North American's capsule design was already fixed and was not going to be changed. That was not the answer Mattson wanted to hear, so he tried coaxing Stubbs into adding an Apollo model to his test. Stubbs replied that he was "running a little short" on funds and was in charge of a "low-key kind of operation." He would like to do it, of course, as he was trying to do a systematic study and was planning to write a formal technical report. If Mattson could obtain the funding, Stubbs told Langley's agent in Houston, then he would be glad to go ahead with the test.¹⁶

Mattson made an appointment with the Manned Spacecraft Center's Joseph N. Kotanchik, NASA's main technical monitor for spacecraft structures work on the North American contract. Kotanchik, like many of the other Houston officials, was a Langley old-timer; he had been a key member of the design team that had built Langley's Structures Research Laboratory in 1939–1940. Unfortunately, he and Mattson did not get along well. Perhaps it was because Kotanchik was quite formal, a northerner, and an MIT graduate, whereas Mattson was usually informal, a loquacious southerner by disposition if not by birth (he was born in New Jersey), who was educated at North Carolina State University in Raleigh. Perhaps the friction also stemmed from the professional difficulties Kotanchik had experienced while at Langley. If Mattson had not had previous dealings with Kotanchik, he would not have even bothered to make an appointment. Mattson usually just walked into someone's office, gave a warm greeting, sat down, and started talking. No one just walked in on Kotanchik except his bosses.

Kotanchik did not want to be bothered with Mattson and told him to be quick. Mattson promptly asked for a transfer of \$40,000 to cover the costs of Sandy Stubbs's impact loads test on a solid model of the Apollo command module at Langley. Kotanchik flatly refused, and essentially told Mattson to get out of his office. According to Mattson, Kotanchik said, "Don't you know that we're going to have a full-scale test that we've spent a million dollars on? Don't you know that it will get us all the information we need?" Mattson tried to explain about Langley's experience with the problem of flexible bottom structures oilcanning and the resonance of impacting boilerplate capsules, about the character of the data spike, and about the need for solid-model testing, but Kotanchik would not listen. "Well, I got kind of hot about that," Mattson remembers. "But the business I was in, you couldn't stay hot too long. You just momentarily got shook up, but then forgot about it real quick. But I put it on the back burner and I made my contacts with North American." In addition, he told Charles Donlan

Spaceflight Revolution



L-65-3649

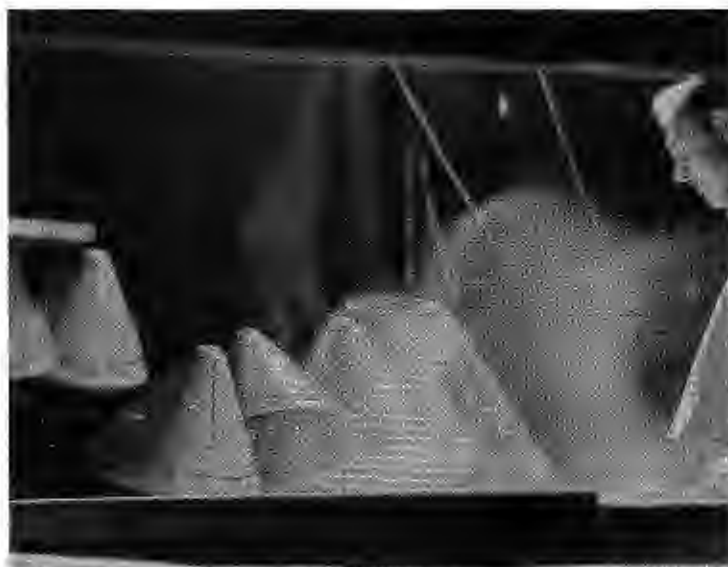

L-61-8040

One of Langley's notable behind-the-scenes contributions to the success of Project Apollo was its testing to assure the landing integrity of the returning command module whether the capsule splashed down into water (top) or maneuvered to a soft landing on earth (below).

about Kotanchik's refusal. Donlan, understanding the good sense of what Mattson was trying to do, told him to tell Sandy Stubbs to go ahead and include a solid model of the Apollo command module in his tests, because Stubbs wanted to do the systematic testing anyway. Langley management would just have to find another way to pay for it.¹⁷

By the day of the big drop test in California in late September 1964, Mattson had developed such good rapport with one of the North American representatives that Mattson's office had been hooked up by telephone to the North American office in Houston, which was linked to the test site in California, so he could hear a blow-by-blow, "real-time" narration of the entire command module drop test. The test did not go well. As Mattson remembers, the gist of the telephone narration originating in Downey was as follows: "All right, the capsule drops. It lands in the water. My God, it's sinking. It has gone in and split wide open. All the mannequins are drowning. The whole spacecraft is in ruins." At that moment, it was clear to everyone that a minor catastrophe was at hand; at that moment, also, Mattson's telephone hookup was cut off.¹⁸

Mattson knew he had "a hot one." Raw technical data existed at Langley, or soon would, that might be the key to solving the problem; but what exactly was he to do with this knowledge, and when? He decided it was best to bide his time and see what developed, because before long something would surely "hit the fan." In a few days, NASA and North American put together an Impact Test Program Review to look into the splashdown of the wrecked command module. "You wouldn't believe the collection of structural experts and spacecraft experts that all convened at Houston." Into these meetings sneaked Axel Mattson. He sat in the back trying to be inconspicuous but listening carefully to all that was said. By the third day of these meetings, chaired by Kotanchik, the engineers involved had come up with a plan of attack for solving the Apollo spacecraft's splashdown structures problem; the plan was basically to retest after strengthening the overall structure of the command module with special attention to increasing the thickness and stiffness of the heat-shield structure. The only way to strengthen the structure was to add material and move toward a solid-model capsule test program similar to the one that had been conducted at Langley for Mercury. At this point, very late in the course of the meetings, Mattson began to "lick his chops," because the questions then became: "Who has got the impact loads? Who knows what they are?" These data were apparently not available, but Mattson—and Mattson alone—knew how to get them.¹⁹

Joe Kotanchik knew Mattson knew. From his seat in the front of the auditorium, the chairman of the meeting nervously looked around the room until he spotted the one man in the back with a wry smile on his face; then, Kotanchik called for a coffee break. He immediately got up and pointed his finger at Mattson and motioned the Langley interloper to follow him into his office. Inside he asked Mattson if he had heard what it was that was needed to move on with the spacecraft verification program. Mattson, with

Spaceflight Revolution

more than a little personal satisfaction, answered that he had indeed heard and that it was “exactly what I was talking about in here when I came in two months ago, Joe. I was trying to get that damn spike. They don’t know what that spike is. They don’t know the magnitude of the impact loads that busts things up.” Kotanchik, however, close to panic, was in no mood for such a speech and told Mattson to shut up. Mattson did, his victory sweet enough without rubbing it in. He told Kotanchik that he would have Sandy Stubbs on an airplane and in Houston by tomorrow morning—which he did. “And that’s how NASA got the information it needed.” Stubbs did a terrific job presenting his research findings to Kotanchik’s assembled experts: he discussed the pertinent parameters of his 1/4-scale model of the Apollo command module, presented the acceleration and pressure data for the capsule’s landings on water, and explained a slide with a cross section of the solid model showing its construction details. In the ensuing years, Stubbs went on to make a major contribution to understanding the impact dynamics that would affect the Apollo command module upon splashdown.²⁰

Mattson never wrote a report on the affair, but he, too, had made a contribution. It was the sort of undercover technical work that did not make its way into the history books, but nothing in his service for Apollo, or for Langley, ever gave Mattson greater pride or satisfaction.

Inside the Numbers

Mattson did write other reports. At least once a year, he put together a detailed inventory, “Langley Research Center Tests of Interest to Project Apollo,” for Bob Gilruth at the Manned Spacecraft Center and Floyd Thompson at Langley. The document described briefly the tests being done by Langley researchers in support of Apollo, identified the research divisions and facilities in which the work was being done and the project engineers conducting it, gave the scheduled test dates, and offered some associated remarks. The purpose of the report was dual: to demonstrate how much Langley was doing to support the lunar landing program and to show the Manned Spacecraft Center the wide range of Langley research that could perhaps be useful to Apollo. Mattson distributed copies of this unpublished typescript to four or five of the most important Apollo program managers in Houston, including the manager of the Apollo Spacecraft Program Office (in 1963, Joseph F. Shea).²¹

Although it was self-serving, Mattson’s regular inventory nevertheless provided a rather accurate survey of everything being done at Langley that was in any way related to Apollo. Every item listed was legitimate. Nothing was invented, although the breadth or depth of certain studies was sometimes stretched a bit to make them seem more applicable to Apollo than they really were. Still, these informal reports provide an unusually complete record of how much Langley did in the service of Apollo, at least as reported by Mattson between December 1962 and February 1968.



L-62-9222

Project Fire explored the effects of reentry heating on Apollo spacecraft materials. Although the ultimate tests involved Atlas rockets carrying recoverable reentry packages, the flight tests from Cape Canaveral were preceded by a series of important wind-tunnel tests at Langley, as shown in this photo from 1962.

Langley's work on Apollo grew steadily from 1962 to 1968, with an apparent peak in the period covered by Mattson's March 1966 report. Of the three major research groups in Langley's organization after the laboratory's formal reorganization in late 1964, Group 1, under the direction of Francis B. Smith, did the most work for Apollo—133 projects (85 of them discrete) compared with 92 (46 discrete) for Group 2, headed by John E. Duberg, and 98 (51 discrete) for Group 3, headed by Laurence K. Loftin, Jr.

Besides the three research directorates, two other major organizations at the center contributed to Apollo. One of them, the Office for Flight Projects, led by Eugene C. Draley, actively supported Apollo; within the office, the Applied Materials and Physics Division reported 43 Apollo-related projects. This organization, formerly PARD, was particularly busy with work for Project Fire, an important NASA effort to study the effects of reentry heating on a spacecraft returning to earth at a high speed. Fire, for which Langley created a special program office in May 1961 (under the direction of Herbert A. "Hack" Wilson), not only consisted of flight tests from Cape Canaveral involving Atlas rockets carrying recoverable reentry packages but also involved a considerable amount of Langley wind-tunnel testing. Two Fire missions eventually took place. The first, launched on 14 April 1964 from Wallops Island, fired a payload into the atmosphere

Spaceflight Revolution

Number of Langley Research Projects
Directly Related to Apollo Program, 1962-1968

Directorate	Dec. 1962	Dec. 1963	Nov. 1964	Nov. 1965	Mar. 1966	Feb. 1968
Group 1						
ACD	0	0	0	1	1	0
FID	x	x	x	x	x	8
IRD	1	6	4	9	9	1
SMD	4	9	19	19	19	23
Total	5	15	23	29	29	32
Group 2						
DLD	7	7	9	12	13	8
SRD	2	5	9	7	8	5
Total	9	12	18	19	21	13
Group 3						
APD	6	5	9	5	5	4
FMTD	10	5	2	2	3	1
FSRD	9	10	6	6	6	4
Total	25	20	17	13	14	9
Flight Projects						
LOPO	x	0	0	1	1	4
MORL	x	0	0	2	2	0
AMPD	0	2	5	10	11	15
Total	0	2	5	13	14	19
Engineering and Technical Services						
FVSD	x	x	x	x	x	1
ESD	0	0	0	0	0	0
MSD	0	0	0	0	0	0
PMD	0	0	0	0	0	0
RMFD	0	0	0	0	0	0
Total	0	0	0	0	0	1

x division did not exist

ACD Analysis and Computation Div.

FID Flight Instrumentation Div.

IRD Instrument Research Div.

SMD Space Mechanics Div.

DLD Dynamic Loads Div.

SRD Structures Research Div.

APD Aero-Physics Div.

FMTD Flight Mechanics and Technology Div.

FSRD Full-Scale Research Div.

LOPO Lunar Orbiter Project Office

MORL Manned Orbiting Research Laboratory

AMPD Applied Materials and Physics Div.

FVSD Flight Vehicles and Systems Div.

ESD Electrical Systems Div.

MSD Mechanical Services Div.

PMD Plant Maintenance Div.

RMFD Research Models and Facilities Div.

at a speed in excess of 40,000 kilometers an hour, the velocity that the Apollo spacecraft returning from the moon was expected to reach. The second, on 22 May 1965, basically confirmed the findings of the first mission, which indicated that “the radiation and the temperatures that would be experienced by an Apollo spacecraft reentry were less severe than expected.”²² Spacecraft engineers at Houston and North American made use of this important data from Project Fire in designing and qualifying Apollo’s heat shield.

Even Langley’s Office of Engineering and Technical Services, Langley’s fifth directorate, which normally was not involved in much research, took on a special Apollo project by conducting a study of an electrolytic chlorinator for water sterilization.

The Simulators

The most active of all Langley divisions in Apollo work was the Space Mechanics Division (SMD) of Group 1. This division conducted more studies related to the lunar landing mission than did any other division at Langley, perhaps because it was in this division, previously known as the Theoretical Mechanics Division, that LOR had germinated.

The essence of SMD’s contributions to Apollo rested in its simulation research. This was a field of work that dated, at the center, to the early 1940s when manned simulation for aeronautical R&D began because of the need for World War II pilot trainers. In the following 15 years, with significant advances in servomechanism and control theory and, more importantly, in analog and digital computers, simulation technology made a quantum leap forward. A new generation of intricate and capable machines was developed just when such simulators were needed for spaceflight. As Langley’s foremost simulation expert, Arthur W. Vogeley, head of SMD’s Guidance and Control Branch, said in a speech to the American Society of Mechanical Engineers in 1966, “Simulation is now big business. In total investment of professional manpower and facilities it is larger now than the whole aviation industry was not many years ago. Simulation is growing rapidly—exponentially, it seems. Where it will go in the next 15 years is anybody’s guess.”²³

The Sputnik crisis had made simulation research and astronaut training absolutely vital—in large part because human ambitions began to outstrip human understanding; simulators were needed to fill in the gaps in the basic knowledge about spaceflight. Building simulators to investigate the interface between the airplane and the pilot had been a difficult challenge for aeronautical researchers prior to the spaceflight revolution; building machines that simulated the interface between astronaut and spacecraft in the weightless environment of outer space was an even tougher job—but one that had to be done. In Projects Gemini and Apollo, astronauts and spacecraft were to be committed to major, complex, and untried maneuvers

Spaceflight Revolution

which, of necessity, had to be carried through to a successful completion, and usually on the first attempt. Simulation was vital to success.

Very little simulation was necessary for Project Mercury, but Project Gemini entailed orbital rendezvous and docking, which was a more dangerous and complex maneuver than sending a capsule into orbit. Learning how to link two spacecraft or spacecraft modules in orbit—an operation required by Apollo's LOR mode—ultimately became the primary purpose of Project Gemini, NASA's second man-in-space program. Many people fail to appreciate the basic purpose of Project Gemini, which was to serve as a bridge between Mercury and Apollo and to develop the techniques of rendezvous and docking, spacewalking, and long-duration flights required by the Apollo lunar landing mission.²⁴

Docking itself was a straightforward operation, very much like the mid-air refueling of a jet airplane, which was a maneuver that experienced pilots routinely managed just by flying "all eyeballs" and by the seat-of-the-pants. Rendezvous, however, seemed to be an altogether different matter. Michael Collins had more than his share of experience with the "dark mysteries" of rendezvous during his Gemini X and Apollo 11 flights: "Sir Isaac Newton, when formulating the laws of gravity and motion, had no idea how difficult he was making it for those of us who would fly his circles and ellipses. It was simple enough to explain, with a chalkboard or, better yet, a powerful digital computer, but in flight one had to be extraordinarily careful not to make a false move, not to trust the eyes alone, not to fire the engines unless each maneuver had been checked and double-checked." Collins, one of the most thoughtful astronauts (and best writers) to comment on his experiences in space, captures what it was like for a Gemini pilot to try to catch and rendezvous with his Agena target/docking vehicle some 2 miles ahead of him:

The pilot sees the Agena's twinkling light out the window, points the nose of the Gemini at it, and fires a thruster to move toward the Agena. For a short time all seems well, and the Agena grows in size. Then a strange thing happens: the Agena begins to sink and disappears under the Gemini's nose. Then minutes later it reappears from below, but now it is going faster than the Gemini and vanishes out front somewhere. What has happened? When the Gemini fired its thruster it increased its velocity but also its centrifugal force, causing its orbit to become larger. As it climbed toward its new apogee, it slowed down, so that it began to lose ground compared to the Agena. The Gemini pilot should have fired a thruster to move *away* from the Agena, causing him to drop down below it into a faster orbit, and begin to overtake it. Then, when the Agena reached a precisely calculated angle above him, he could thrust toward it and his resulting orbit would intercept that of the Agena. Sir Isaac demands that you play his game his way.

Rendezvous in space could turn sour with paralyzing swiftness. An on-board computer might fail, a gyroscope might tilt the wrong way, or some other glitch might occur to complicate the performance of a necessary maneuver.

Pilots of both the LEM and the CM had to be ready to make crucial decisions instantaneously. They could not simply say to one another "Meet Me Over St. Louis" and expect their two spacecraft to rendezvous successfully in space. The usual way of piloting in atmospheric flight just would not work. Because of these stark new realities about flight in space, Collins notes, "a great amount of care and pre-planning had to go into the planning of, and hardware for, the rendezvous missions."²⁵

Engineers in Langley's Theoretical Mechanics Division (which was actually renamed the Aero-Space Mechanics Division before becoming SMD) had become heavily involved in certain aspects of spaceflight simulation even before Sputnik. Their work for the X-15 program (when they were still NACA employees) had led them to construct and "fly" an X-15 attitude and control simulator. But Sputnik set them loose; over the course of the next 10 years they conceived, built, and operated nine new simulators. These included a Rendezvous and Docking Simulator, a Rotating Vehicle Simulator to study the effects on astronauts of long stays in a rotating space station, and a Reduced Gravity Walking Simulator that was used to evaluate the effects of lunar gravity on man's walking and running capabilities (with and without pressure suits). A Lunar Orbit and Let-down Approach Simulator (LOLA), a \$1.9-million facility, was designed so that pilots could experience the same sort of visual cues that they would encounter while navigating and controlling a spacecraft in the vicinity of the moon. The Lunar Landing Research Facility, a mammoth \$3.5-million facility, simulated manned lunar landings, and a Projection Planetarium was built that could either project stars on a plastic dome while test pilots sat on a rotating gun turret "spacecraft" to get the feel of heavenly movement or generate a horizon-to-horizon view of Florida as seen from about 100,000 feet for "out-the-window" studies of Apollo launch-abort problems. The Virtual Image Rendezvous Simulator used a closed-circuit television system and analog computers to represent a moving target vehicle for rendezvous and docking studies; a Water Immersion Simulator used a water tank for investigating problems associated with manned extra- and intra-vehicular activities in reduced-G environments; and a One-Man Propulsion Research Apparatus suspended a person equipped with vertical thrusters and translation and attitude controllers from a lightweight gimbal unit for maneuverability studies in reduced-gravity fields.²⁶ Two of the spaceflight simulators in particular—the Rendezvous and Docking Simulator and the Lunar Landing Research Facility—made significant contributions to the successes of projects Gemini and Apollo.

In the months following NASA's adoption of the LOR concept, a team of Langley engineers led by Arthur W. Vogeley and Max C. Kurbjun of the Space Mechanics Division, and including Roy R. Brissendon, Alfred J. Meintel, Jr., Jack E. Pennington, and Marvin C. Waller, designed an unusual research facility explicitly for the purpose of studying the special problems of rendezvous and docking. In its essentials, the design belonged

Spaceflight Revolution

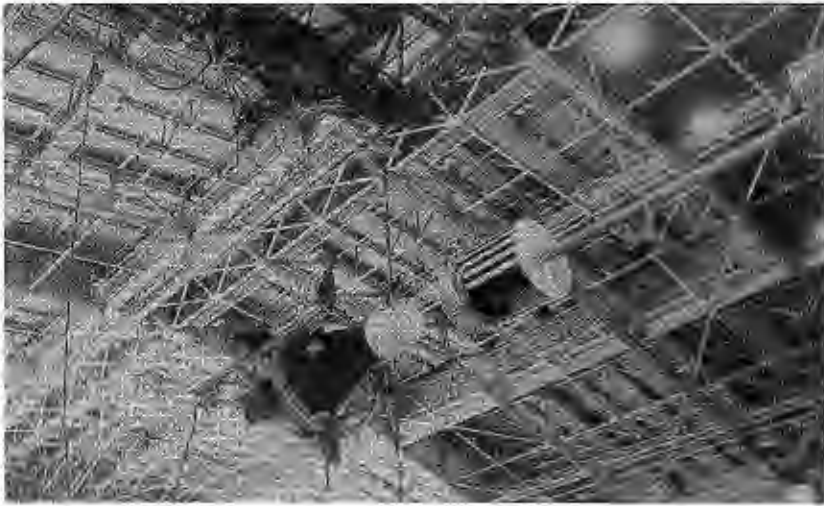

L-63-5016

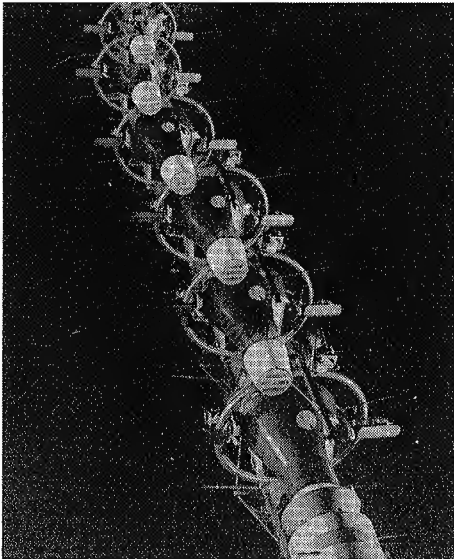

L-64-1610



L-62-9652

The Langley Rendezvous and Docking Simulator suspended from the roof of the West Area airplane hangar (top). Bottom left, a time-lapse look at a successful docking. Bottom right, an unidentified pilot “eyeballs” his way to a docking by peering through the portal in his capsule.

to Vogeley, the head of SMD's Guidance and Control Branch, and entailed full-scale mock-ups of the Gemini and Apollo cockpits that could be hung from an overhead carriage and cable-suspended gimbal system. This entire assembly could then be attached to an overhead moving crane that moved along a 210-foot track running along the rafters of Langley's cavernous West Area hangar. Pilot astronauts could then "fly" the cockpits both in night-time and daylight conditions to rehearse and perfect rendezvous and docking skills.

Upon its completion in early 1963, SMD began using this ingenious simulator to study the finer points of various rendezvous missions. (The simulator included a general-purpose analog computer, which made it possible for the pilot inside the gimbal to experience all six degrees of motion freedom.) Experience with the facility confirmed something that Vogeley and other experienced guidance and control experts at Langley had believed for some time: rendezvous, if practiced, was not as mysterious or as difficult as many people imagined. In fact, it could be accomplished quite easily.²⁷

Nonetheless, without their experience in the Rendezvous and Docking Simulator, the Gemini and Apollo astronauts would not have been as well prepared for handling the pressures of rendezvous. "We trained an awful lot of astronauts," Vogeley remembers with pride, "who all appreciated the realism of the simulator's visual scene. It gave us a lot of satisfaction just to show that NASA could do that sort of thing in a unique piece of ground equipment that only cost about \$300,000. I think we got our money's worth."²⁸ In his branch office Vogeley kept a picture of the simulator that was signed by all the pilots who ever used the facility—with one exception. Apollo astronaut Ed White, who visited Langley twice to fly on the simulator, died in the tragic launchpad fire at Cape Kennedy on 27 January 1967 before he could add his autograph to the list.

The other simulator to contribute in a significant way to the success of Apollo was the Lunar Landing Research Facility, an imposing 250-foot-high, 400-foot-long gantry structure that became operational in 1965 at a cost of nearly \$4 million. Conceived in 1962 by engineer Donald Hewes and built under the careful direction of his quiet but ingenious division chief, W. Hewitt Phillips, this gigantic facility was designed to develop techniques for landing the rocket-powered LEM on the moon's surface. Because the moon had no atmosphere and its gravitational pull was only one-sixth that of the earth's, piloting the LEM would be completely unlike atmospheric flying. The thrust of the LEM's rockets in a vacuum would produce unusual and abrupt up-and-down, side-to-side, or rolling motions. In addition, the lack of an atmosphere would create a harsh light. As the astronauts landed, they would face this bright glare, as well as deep, dark shadows, which would skew depth perception. Some unique problems had to be overcome to make a pinpoint lunar landing. Some means of simulation seemed called for; the question was how to do it.

Spaceflight Revolution



L-69-7140



L-63-3268

The two men responsible for the design and early operation of the Lunar Landing Research Facility were Donald Hewes (left) and his division chief, William Hewitt Phillips (right).

Hewitt Phillips, a soft-spoken, MIT-educated engineer born in Port Sunlight, England, remembers how the idea for the Lunar Landing Research Facility originated between 1962 and 1963: “Since we knew that the moon’s gravity is one-sixth that of the Earth’s, we needed to support five-sixths of the vehicle’s weight to simulate the actual conditions on the moon.”²⁹ Perhaps, some practical method could be devised to lower the apparent weight of a mock-up LEM to its lunar equivalent by a method of suspension using vertical cables attached to a traveling bridge crane.

From this basic notion, the design evolved. A huge gantry structure was built that would dominate Langley’s landscape for years to come. Phillips and Hewes wanted the supporting gantry to be even taller, but because of the heavy military air traffic from adjacent Langley AFB, the structure was limited to 200 feet. The completed facility, however, stood 240 feet 6 inches, excluding the top warning lights and antennae. Two long cables provided the desired vertical lifting force equal to five-sixths of the vehicle’s weight, thereby opposing the pull of the earth’s gravity and simulating the low gravitational force of the moon’s surface. The cables were attached to a servocontrolled hoist system in a dolly unit mounted under a traveling bridge; the hoist system was controlled automatically by load cells in each support strut. As the test vehicle moved up and down and back and forth in response to the controlling pilot, the bridge and dolly responded to signals from the vehicle and from cable angle sensors at the top of the cables to

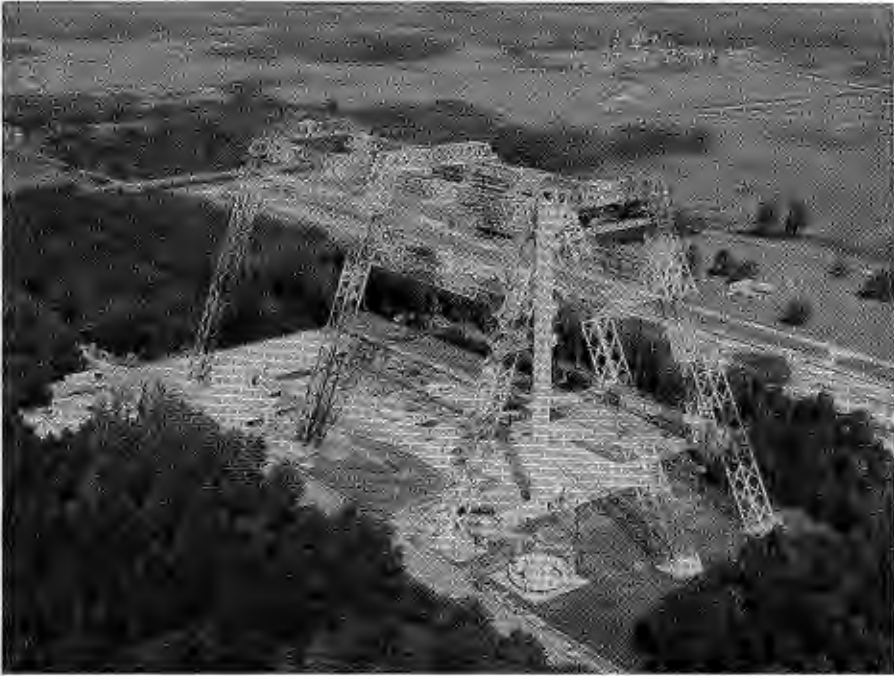

L-69-6324

Langley's Lunar Landing Research Facility, completed in 1965, helped to prepare the Apollo astronauts for the final 150 feet of their lunar landing mission by simulating both the lunar gravity environment and the full-scale LEM vehicle dynamics.

stay directly over the vehicle at all times and to keep the cables vertical. Because the bridge and dolly system were driven hydraulically, they provided a responsive servocontrol system. Moreover, safety features were built into the system to prevent the lunar landing vehicle from crashing or the bridge and the dolly from overrunning their tracks in the event of an equipment malfunction or the pilot exceeding the safety limits of the system.

The lunar landing test vehicle itself could be flown up to about 17 miles per hour within the confines of the overhead structure, which provided a travel range 400 feet long, 50 feet wide, and 180 feet high. The vehicle could also be hoisted to the overhead platform, where two cables connected to the trolley units on the lower horizontal truss structure could catapult the vehicle downward at 35 miles per hour. To make the simulated landings more authentic, Hewes and his men filled the base of the huge eight-legged, red-and-white structure with dirt and modeled it to resemble the moon's surface. They erected floodlights at the proper angles to simulate lunar light and installed a black screen at the far end of the gantry to mimic the airless lunar "sky." Hewes personally climbed into the fake craters with cans of everyday black enamel to spray them so that the astronauts could experience the shadows that they would see during the actual moon landing.

Spaceflight Revolution



L-68-547



L-67-9108

Langley engineers designed the control cab of the Lunar Landing Research Facility's original landing module (top left) from the cockpit of a Bell helicopter. To make it similar to the actual LEM, they eventually redesigned it with a stand-up cab (top right and bottom).



L-69-4361



L-67-3857

With floodlights shining down to simulate lunar light and the base modeled to resemble the lunar surface, 24 astronauts practiced landings at the Lunar Landing Research Facility between 1965 and 1969.

As a final touch to the facility, Hewes attached to an overhead, lightweight trolley track a simple contrivance, which came to be known as the Reduced Gravity Walking Simulator. Made of canvas slings, steel cables, a small trolley, and a wooden walking surface, this rig tilted a walker some 80 degrees from vertical by holding him up with two cables. Astronauts, thus suspended, could practice moonwalking down the plywood surface. They made 12-foot jumps with ease, rapidly climbed a “vertical” pole with one hand, and generally got a feel for what it would be like to traverse the lunar surface.³⁰ The Reduced Gravity Walking Simulator became quite a hit with all press members who visited Langley during the Apollo era. In 1968, for example, CBS anchorman Walter Cronkite suited up in an orange astronaut outfit for what turned out to be a rather comical televised walk on the moon.

Of course, the landing facility was a complicated system and had kinks that had to be ironed out. The electrohydraulic system that kept the crane platform directly over the flight vehicle and the cables vertical was extremely involved. The facility had a wonderful assortment of structural, cable-stretch, and pendulous frequencies that were unpredictable and required innovative compensation systems. The LEM model was attached to the cables through gimbal rings allowing pitch, roll, and yaw motions produced by a hydrogen peroxide rocket attitude control system. The one-sixth weight not lifted by the cable system had to be lifted by throttleable hydrogen

Spaceflight Revolution



L-68-8308

The spaceflight revolution captivated many in the news media, including then-CBS news anchorman Walter Cronkite. During a 1968 visit to Langley, the adventurous Cronkite tried out the Reduced Gravity Walking Simulator—a series of cable-supported slings hanging down from the Lunar Landing Research Facility designed to approximate lunar locomotion.

peroxide thrusters fixed to the vehicle structure. With such marvelous complexities, it is no wonder that it took some time for the Langley engineers to perfect their gargantuan but sensitive and responsive mechanism.

As Neil Armstrong testified, once the kinks were ironed out, the Lunar Landing Research Facility was “an engineer’s delight.” The flying volume was “limiting, but adequate to give pilots a substantive introduction to Lunar flight characteristics.” Moreover, thanks to the built-in safety features, whereby the cable system could be locked if the vehicle was out of control, the astronauts were able to “investigate unorthodox attitude, trajectory and control combinations which would be impractical in a free-flying simulator.”³¹

Armstrong knew the limitations of other simulators from personal experience. On 6 May 1968, during a test flight of a free-flying Lunar Landing Training Vehicle at NASA’s Flight Research Center at Edwards AFB in California, he was almost killed. Historian Richard Hallion, author of the

definitive book on the history of NASA's Flight Research Center, relates the accident:

While hovering 10 meters above the ground, the vehicle suffered a loss of helium pressure in its propellant tanks, causing shutdown of its attitude control rockets. It started nosing up and rolling over, and Armstrong immediately ejected. His zero-zero seat kicked him away from the stricken craft, which tumbled into the ground and exploded as the astronaut safely descended by parachute.

"It was a sad fate for a pioneering flight craft," writes Hallion, a great lover of flying machines. Indeed, but it almost sealed a far worse fate for America's first man on the moon.³² From that day on, Neil Armstrong made no flights in the Lunar Landing Training Vehicle or any other free-flying test vehicle simulating lunar landings. He did, however, continue to use Langley's facility to practice landings.

Ironically, in the early days of the facility's development, many people associated with the Apollo program did not see the need for such a facility and questioned whether it would ever work. How could a vehicle hanging from cables, like a child's top jumping at the end of a string, adequately simulate moon landings? Axel Mattson recalls that Gilruth's engineers in Houston never expressed much enthusiasm for the device. They felt that the best simulations would be provided by helicopters approximating final descent trajectories (all Apollo crew members did in fact become qualified helicopter pilots) by a test program involving a modified Bell X-14A VTOL aircraft, or by the special free-flight lunar landing research vehicles being developed by NASA for the test flights at Edwards. All these research vehicles made significant contributions to developing techniques for the lunar landing. But Langley's controversial Lunar Landing Facility provided astronauts with a unique experience. So realistic was its imitation moonscape, for example, that Neil Armstrong remarked that when he saw his shadow fall upon the lunar dust, it was exactly as he had seen it at the landing facility at Langley.³³

Some of Langley's other simulators did not make significant contributions to Apollo—or to any other program. The clearest case in point was the intricate LOLA, which started operating in 1965 at an imposing cost of nearly \$2 million. This simulator was designed to provide a pilot with a detailed visual encounter with the lunar surface; the machine consisted primarily of a cockpit, a closed-circuit TV system, and four large murals or scale models representing portions of the lunar surface as seen from various altitudes. The pilot in the cockpit moved along a track past these murals, which would accustom him to the visual cues for controlling a spacecraft in the vicinity of the moon. Unfortunately, such a simulation—although great fun and quite aesthetic—was not helpful because flight in lunar orbit posed no special problems other than the rendezvous with the LEM, which the device did not simulate. Not long after the end of Apollo, the expensive machine was dismantled.³⁴

Spaceflight Revolution

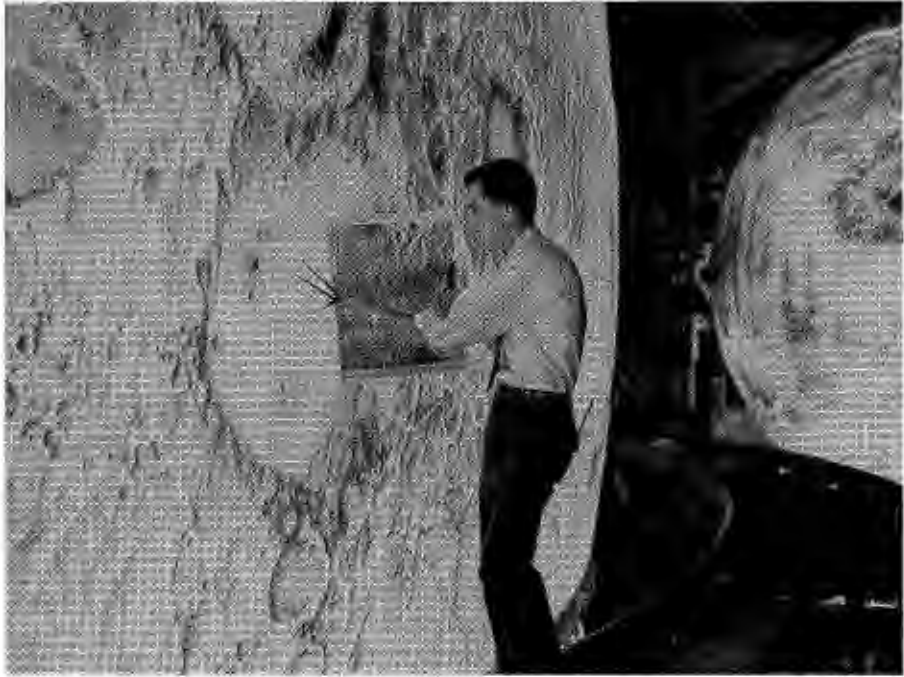

Although as much fun as riding through the fun house at the county fair, the \$2 million LOLA proved unnecessary. In this photo from 1965, a Langley technician takes great care to make sure that the surface features of the moon are being represented exactly.

Rogallo's Flexible Wing

More than any other division at Langley, the Full-Scale Research Division acted as a “service effort” for Apollo. Testing in the high-speed wind tunnels of this division provided essential data in the transonic regime for the moon shot. Not all Apollo work carried out in the Full-Scale Research Division, however, involved high-speed aerodynamics. Perhaps the most interesting and potentially significant technologies developed in this division involved low-speed aerodynamics—specifically, a proposed Apollo capsule recovery system that used a controllable paraglider. This concept, which was eventually turned down both for Gemini and Apollo, was the brainchild of Francis M. Rogallo, an ingenious thinker and kite-flying enthusiast who worked in the 7 × 10-Foot Tunnel Branch.

Although Bob Gilruth and many other engineers responsible for Project Mercury considered the ballistic capsule approach “an elegant solution” to the problem of quickly putting a person in orbit, no aeronautical engineer was especially happy with the plan.³⁵ Their dream was for the spacecraft

to return to earth using “wings and wheels”—that is, to really fly down through the atmosphere to a landing on a conventional runway.

NASA placed its hopes for such an airplane-like landing on an unusual inflated-fabric flexible wing, or parawing. Such a wing was being developed at Langley in the early 1960s under the intellectual direction of Francis M. Rogallo. Rogallo’s idea for Gemini, as well as for Apollo, was to pack away a carefully designed parawing like a parachute until the spacecraft fell to about 60,000 feet, at which time an elaborate unstowing and unfurling process began. By 20,000 feet, if all went well, the descending spacecraft would turn into the world’s heaviest hang glider, suspended under a dart-shaped parawing. The astronauts themselves would then bring the soaring craft down to a landing either on water or on soil.³⁶

Rogallo had started at NACA Langley in 1936 after graduation from Stanford University, and since 1945 the flexible wing had been a pet project. A survey of the history of the parawing provides not only an understanding of the genesis of one of Langley’s most intriguing—if never used—developments for Apollo but also insight into the sudden and dramatic impact of Sputnik and the spaceflight revolution on the course of independent research at Langley.

Rogallo and his wife, Gertrude, spent their spare time flying home-built kites at their beach house at Nags Head, North Carolina, which is near Kitty Hawk. By the end of World War II, this hobby had begun to give the couple ideas for unconventional vehicles, such as hydrofoil boats, ground-effect machines, V/STOL aircraft, and flexible wings. Because they could not find any organization, including their own NACA, to support R&D for their ideas, they “decided to do what we could privately as time permitted.” Initially their efforts focused on configurations resembling boat sails; later, their designs were similar to parachutes. Finally, they concentrated on shapes somewhere between boat sails and parachutes—flexible wings. By the end of 1948, the couple had developed a flexible kite, which the Rogallos called “Flexi-Kite,” and a type of gliding parachute, which they later named a “paraglider.”³⁷

In 1948, Rogallo and his wife filed a patent for a V-shaped flexible wing, which was awarded (U.S. Patent No. 2,546,078) in March 1951. From the outset, the inventors had thought of their parawing as a wing not only for sport gliders but also for military and civil powered aircraft. No one, however, took their proposals seriously. As Rogallo remembers, when meeting friends and acquaintances, they were generally greeted with, “How’s the kite business?” The Rogallos had resorted to selling their Flexi-Kite as a toy in order to illustrate the parawing principle and help finance their work. Francis Rogallo would often say in later years that toys should copy the real thing and not the other way around.³⁸

For the first seven years of its development, the motivation behind the flexible wing had been “purely aeronautical,” but that changed in 1952 when the Rogallos saw the *Colliers* magazine that ran the exciting series

Spaceflight Revolution

Francis and Gertrude Rogallo (right), inventors of the V-shaped flexible "parawing." In December 1961, Langley flight-tested a 50-foot parawing's ability to bring down safely a model of a manned space capsule from a few thousand feet above Plum Tree Island (below), an old army bombing range near Langley Field.



L-63-5441



L-61-8041

of stories about spaceflight. Francis Rogallo was struck by the issue's beautiful illustrations of rigid-winged gliders mounted on top of huge rockets. As he recalled later in a 1963 speech to the American Astronautical Society, "I thought that the rigid-winged gliders might better be replaced by vehicles with flexible wings that could be folded into small packages during the launching." In August 1952 he met Dr. Willy Ley, one of *Colliers* consultants, and told Ley his thoughts about flexible wings for astronautics. In the conversation Rogallo mentioned that the technology of flexible wings might someday prove very useful when spacecraft commute regularly between planets: a rocket ship returning from Mars could pop out flexible wings as it entered the earth's atmosphere and glide the last 100 or 200 miles home, saving "the stockholders" that much fuel. "But the time was not yet ripe."³⁹ (Note that Rogallo imagined, perhaps in jest, that private corporations would be sponsoring the interplanetary travel, not governments.)

In April 1954, hoping to gain acceptance of his concept for aerospace applications, Rogallo gave a presentation, complete with glider model demonstrations, to the local Tidewater reserve unit of the Air Force Research and Development Command. Two months later, he submitted a proposal to include parawing research in the NACA budget, but the proposal was rejected. Indefatigable, he submitted a proposal to discuss his flexible wing concepts at the annual meeting of the Institute of Aeronautical Sciences (IAS). This was "the first [proposal] that actually reached the program committee after several tries," but it too was turned down. The IAS rejection letter read: "Although the paper is out of the ordinary and looks like it might be fine to hear, it just does not fit into our program."⁴⁰

As it did for so many research projects, the launch of Russia's *Sputnik 1* in October 1957 changed the course of history for the parawing. Even before the formation of NASA in 1958, Rogallo had received NACA approval to make a few crude wind-tunnel and model flight investigations of parawings in the 7 × 10-Foot Tunnel Branch. In December 1958, he made a presentation to the Langley Committee on Aerodynamics, and as he remembers, "gradually people in other divisions became interested and volunteered to investigate parawings in their facilities." During 1959 cloth parawings were tested in the 4-Foot Supersonic Pressure Tunnel at Mach 2, and still other parawing models were deployed at high altitudes (150,000 to 200,000 feet) at nearly Mach 3 from rocket launchings at Wallops Island. In August 1959, von Braun invited Rogallo to Huntsville for a presentation, so "business was picking up."⁴¹

For the next year and a half, into early 1961, Rogallo gave talk after talk on his parawing concept to various technical groups. He spoke at the national aeronautics meeting of the Society of Automotive Engineers (April 1960); at Ryan Aeronautical Company and North American Aviation (May 1960); at the annual IAS meeting in New York City (Jan. 1961); and at local IAS chapter meetings in Lancaster, California, and San Diego

Spaceflight Revolution

(March 1961). By the end of 1960, the Ryan company, the same company that built Charles Lindbergh's *Spirit of St. Louis*, began building a powered man-carrying "Ryan Flex-Wing" at its own expense; Rogallo was on hand in San Diego to witness its first flight. Also, in early 1961, NASA Marshall gave Ryan and North American contracts to study the feasibility of recovering Saturn boosters by means of parawings. NASA in-house studies of the technological capabilities of the wing were made at Marshall and Langley and demonstrated that recovery of the (later canceled) C-2 rocket stage was feasible. By the end of 1961, the DOD let its first parawing contract, to Ryan, for flight tests of the Flex-Wing. The aircraft was later sent to NASA Langley for investigation in the Full-Scale Tunnel. Thereafter, the number of projects and contracts related to parawings increased too rapidly to mention in this brief history.⁴²

"It looked like parawings were here to stay," Rogallo rejoiced at the time, and Sputnik was the reason.⁴³ By the summer of 1963, it appeared that the concept had achieved worldwide acceptance and that the time had come for his parawing study group to give the U.S. government royalty-free license to use its patents, which it did in a ceremony in Washington on 18 July 1963. In a short speech, Rogallo expressed his hopes for the invention: "We feel confident that the civil and military agencies of the government will carry on this work, and we hope private industry will promote use of the concept for business and pleasure as effectively as they have for astronautics and military aeronautics." In a separate ceremony a day earlier, Dr. Hugh Dryden, deputy administrator of NASA, presented Francis Rogallo and his wife with a check for \$35,000 for their development of the flexible-wing concept; at that time, it was the largest cash award ever made by the space agency to an inventor.⁴⁴

Unfortunately, the spaceflight revolution, which had so quickly turned circumstances in the wing's favor, just as quickly turned circumstances against it. That is often the nature of revolutions—to take things full circle. From the beginning, NASA's interest in Rogallo's paraglider grew primarily from the possibility of using it as a controllable space capsule recovery system. When that interest waned, so too did NASA's support for the innovative flight technology.

Given NASA's formal go-ahead for research, Rogallo and his colleagues in the Full-Scale Research Division invested much time, energy, and emotion in the paraglider concept. Several Langley employees shared Rogallo's enthusiasm for the innovative flight technology and even conducted manned flexible-wing flight research during weekends on the Outer Banks with privately owned equipment. Although qualitative in nature, these investigations proved "valuable in providing quick answers and indicating promising directions for the much more costly and time-consuming instrumented but unmanned NASA flight research."⁴⁵ In wind-tunnel studies at Langley, this research covered a broad spectrum of parawing design parameters—everything from the original concept of a flexible lifting surface (indicated

in the engineering data as a “limp paraglider”) to rigid frame gliders with conical and cylindrical canopies.

As this research on the basic technology of the parawing gained momentum at Langley, NASA’s STG, still at Langley at this time, grew interested in the possible application of the foldable, deployable, inflatable-frame paraglider to its Gemini EOR program. Specifically, the STG believed it might be used as part of *Mercury Mark II*, the follow-on to Project Mercury, which ultimately (in January 1962) became Project Gemini. The STG felt that such a wing could be deployed either before or after reentry to provide controlled glide and horizontal landing. Even on a lifting reentry body—NASA was giving “lifting body” technology considerable attention in relation to space station studies during this period (see the epilogue)—tests at Langley and other NASA facilities were showing that a parawing could improve the postentry flight or landing characteristics.⁴⁶

In early July 1961, a few weeks before the second manned Mercury flight by Gus Grissom, Gilruth’s organization initiated three well-funded design study contracts on the paraglider concept with Ryan, North American, and Goodyear. Of these three companies, North American would eventually produce the most acceptable plan—a study to explore the parawing as an earth-landing system for Project Apollo.⁴⁷ A few weeks later, the STG began requesting that studies of the Rogallo-type paraglider be conducted at NASA centers. At Langley this led, on 31 August, to a research authorization for “Free-Flight and Wind-Tunnel Tests of Guided Parachutes as Recovery Devices for the Apollo Type Reentry Vehicle.” By late fall, all of this work came together as a formalized NASA paraglider development program, with Langley and Ames responsible for the wind-tunnel tests and the Flight Research Center for scheduling manned flight tests. Starting in mid-1963, 12 manned flight tests were actually made at Edwards with a so-called Parasev.⁴⁸

If the United States had not been in a hurry to go to the moon, the Rogallo paraglider might have been used as the capsule recovery system for Gemini and Apollo; of course, if the country had not been in such a hurry, it would not have gone to the moon at all in the 1960s—and perhaps would not have gone there ever. As it turned out, the paraglider became “hopelessly snarled in a financial, technical, and managerial morass.”⁴⁹ Richard Hallion recalls the specific problems encountered during the flight tests at Edwards:

Paraglider development involved solving major design difficulties in deploying the wing, ensuring that crew would have adequate control over the parawing-equipped craft, and providing stability, control, and handling qualities. The Flight Research Center’s technical staff was never convinced that the scheme was workable. Eventually, because of poor test results and rising costs and time delays, the idea was dropped from Gemini in mid-1964. FRC engineers and pilots had believed that any vehicle so equipped might present a pilot with a greater flying challenge than contemporary advanced airplanes.



L-62-631

An early version of the single-seat Paraglider Research Vehicle (“Parasev”) is test “flown” in Langley’s Full-Scale Tunnel in January 1962.

These conclusions were based on experience. Flights with the small, single-seat experimental Parasev had proved extremely tricky even in the hands of experienced test pilots. The first machine, *Parasev I*, flew as if “controlled by a wet noodle.” As Hallion records, during one ground tow, a veteran NASA test pilot “got out of phase with the lagging control system and developed a rocking motion that got worse and worse; just as the tow truck started to slow, the Parasev did a wing-over into the lakebed, virtually demolishing the Parasev and injuring [the pilot], though not seriously.” This was not the only time that a paraglider test vehicle would slam into the ground.⁵⁰

The Parasev, built and rebuilt several times, eventually made over 100 flights at Edwards and showed enough progress that it might have proved feasible for capsule reentry if further developed. However, NASA could not wait for its maturation. Besides, the paraglider was “not absolutely necessary, being more technological frosting than cake.”⁵¹ NASA did not need an elegant reentry plan, just a workable one. By early 1964, NASA was committed to a water landing for Apollo. In mid-1964, Gemini’s program

manager, Charles W. Mathews, a former Langley STG engineer, canceled the paraglider. Rogallo's idea would not fly anyone or anything back from space.

Rogallo never gave up on his pet concept and continued to develop it even after he retired and moved with Gertrude to Nags Head. There they spent all their time working on their paragliders for sport aviation and other applications. Before leaving NASA Langley, Rogallo and his colleagues in the Low-Speed Vehicle Branch had continued to explore a very broad spectrum of wing shapes and structures for his flexible wings. Never again, however, would his concept receive the same high level of NASA support and funding that it had received when linked to the manned space programs of the early 1960s. Nevertheless, a Parawing Project Office (under engineer Dewey L. Clemmons, Jr.) continued at Langley until 1967 and kept the research alive.

The Apollo Fire Investigation Board

Langley played one other significant, if very sad, role in the Apollo program. The program seemed to be moving along extremely well, so well in fact that by New Year's Day 1967 many observers believed that President Kennedy's "by the end of the decade" deadline for landing a man on the moon might be achieved a couple of years ahead of schedule. Then tragedy struck—making it abundantly clear to NASA and the nation just how high a price would have to be paid to pursue such bold ventures into the unknown. Early in the evening of 27 January 1967, a fire broke out inside the Block I Command Module sitting on top of the uprated Saturn I 204 rocket on the launchpad of Complex 34 at Cape Kennedy. The fire killed three Apollo astronauts—Gus Grissom, Edward H. White, and Roger B. Chaffee—who were in the capsule for a prelaunch test.⁵²

The next day, Deputy Administrator Robert C. Seamans, Jr., speaking for Administrator Webb, named Floyd L. Thompson chairman of the Apollo 204 Review Board.⁵³ Serving with Thompson were five other NASA officials, one air force official, and one official from the U.S. Bureau of Mines. No one institution was better represented on the board than Langley. Besides Thompson (and probably because of him), the board also included E. Barton Geer, associate chief of Langley's Flight Vehicles and Systems Division, and George Malley, Langley's chief counsel. Furthermore, Max Faget, then of the Manned Spacecraft Center, but formerly a Langley engineer, also served on the board.*

* The other members of the Apollo 204 Review Board were Col. Charles F. Strang, chief of the Missiles and Space Safety Division, air force inspector general, Norton AFB, Calif.; Lt. Col. Frank Borman, astronaut, Manned Spacecraft Center; George C. White, Jr., director of reliability and quality, Apollo Program Office, NASA headquarters; Dr. Robert W. Van Dolah, research director, Explosive Research Center, Bureau of Mines, U.S. Department of Interior, Pittsburgh, Pa.; and John J. Williams, director of Spacecraft Operations, NASA Kennedy Space Center.

Spaceflight Revolution



L-68-9680

Floyd Thompson (left), chairman of the Apollo Fire investigation board, talks with Thomas O. Paine (right), who took over from James Webb as NASA administrator in September 1968.

NASA was handing a terribly difficult job to Langley's 69-year-old director, who was only a year and some months away from retirement. Ironically, someone like Floyd Thompson, with no national public reputation and a surface personality that even some close friends described as a bit "hayseed," would have been out of the question for the investigation committee that was appointed after the *Challenger* accident—even as a commission member let alone as its chairman.⁵⁴ But, as the results of the Apollo fire investigation and the subsequently successful Apollo program demonstrated, Thompson would be the perfect man for the Apollo job. As Robert Seamans once said about Thompson, "I think he acted to fool people a little bit so he could get their measure—and then watch out, you know. Very adaptable. At Langley, through all this chaotic period, he kept it out front doing the right kind of things. And then of course the real crunch came when we had the Apollo fire. The question was, 'Who do we have who

has the ability and the credibility to be responsible for that review?' That's when we put Tommy into that very, very difficult job."⁵⁵ Interestingly, after the mishap of Apollo 13, when exploding oxygen tanks in the service module forced the highly dramatic return of the three astronauts even before they had reached the moon, NASA appointed another Langley center director, Edgar M. Cortright, Thompson's successor, to chair the accident review board. Perhaps this was in part a testimony to how well Floyd Thompson had conducted the Apollo fire investigation.

Within 24 hours of the command module inferno, Thompson and the rest of his committee were on hand at Pad 34, beginning the long and arduous process of finding out why the tragedy had happened. Under Thompson's disciplined direction, the investigation marched along quickly and quietly. This low-profile progress was possible because the inquiry was an internal NASA investigation without the national media exposure that those on the *Challenger* investigation committee would face. By 5 April, after spending about 10 weeks on the job, most of it on site at the Kennedy Space Center, the Apollo 204 Review Board was ready to submit its formal report, which was several thousand pages long including appendixes. According to its terse prose, arcs from faulty electrical wiring in an equipment bay inside the command module had started the fire. In the 100-percent oxygen atmosphere, the crew had died of asphyxia caused by inhalation of toxic gases. The board report concluded with a list of 11 major recommendations for hardware and operational changes.⁵⁶

NASA would need two more years to fix all the problems with Apollo. A special Apollo Configuration Control Board, chaired by George Low, eventually oversaw the completion of over 1300 design changes for the spacecraft. The mending process had really begun, however, with the Apollo 204 Review Board's fast action to a first draft of an investigation report. As chairman and as a person well aware of the inherent dangers of flight research, Floyd Thompson wanted everyone to know that his board's written description of "the defects in the Apollo Program that led to the condition existing at the time of the Apollo 204 accident" should not be interpreted as "an indictment of the entire manned space flight program" or as a "castigation of the many people associated with that program." "Nothing is further from the Board's intent," Thompson emphatically declared. The function of his board had been "to search for error in the largest and most complex research and development program ever undertaken," and that was why the report on the fire commented only on the deficiencies uncovered and did not present a total picture of the Apollo program, including the good points with the bad, or look for scapegoats. However, the report tried to make clear to the nation that such tragedies

Spaceflight Revolution

All three astronauts who died in the Apollo fire had spent a considerable amount of time in simulators at Langley. Gus Grissom (right) at the controls of the Rendezvous and Docking Simulator in 1963; below, Roger Chaffee strapped into the Lunar Landing Research Facility's Reduced Gravity Walking Simulator in 1965. Unfortunately, a picture of Edward White while in training at Langley was not found.



L-63-1515



L-65-8545

would occasionally occur if the bold venture into space was to continue and progress.*⁵⁷

It is unfortunate that tragic accidents such as the Apollo fire and the *Challenger* explosion have to happen for errors to be discovered and corrected. Both events made NASA and its contractors more cautious, and in the case of the Apollo fire, they actually slowed the pace of work so that tasks could be performed more carefully. "It gave everyone not working on fire-related matters a breather, a period to catch up on their work." "In the race for the moon," as Apollo astronaut/historian Michael Collins has written, "no one wanted his piece of the machine to be the laggard, *the one* to hold up the whole procession. Consequently, no one wanted to admit being 'the long pole in the tent' as it was called, and managers were apt to fudge their schedules a bit, hoping someone else would admit to being even farther behind. Many long poles got whittled down to manageable size during the time North American was struggling to get the Command Module back on track."⁵⁸

This scenario really did not apply to NASA Langley; its work to achieve the lunar landing objective was for the most part over by the time the Apollo command module was fixed and ready for its first manned flight (Apollo 7, 11–22 Oct. 1968). Langley's contributions to Apollo had little to do with final preparations but rather rested largely in the groundwork for such an ambitious program. By the time of Apollo 11's historic first lunar landing on 20 July 1969, Langley's multifarious R&D efforts for Apollo had been largely forgotten; except for the Hampton area press, the media gave the center little attention. But without Langley, an American lunar landing that summer day may not have been possible.

"We had a target and a goal," says John Houbolt, one of the few from Langley privileged with an invitation to watch the historic lunar landing event from the viewing room at Mission Control in Houston. "Congress

* By the authority granted to the center in a letter from Deputy Administrator Robert Seamans on 27 February 1967, NASA Langley became "the custodian of all pertinent physical evidence, reports, files, and working materials dealing with the investigations and review of the Apollo 204 accident." (Copy in Apollo 204 Review Board files, Langley Central Files.) In 1978, Langley shipped all the documentary records of the review board to the National Archives; however, it kept all the related hardware, including the Apollo capsule itself. In 1990 preparations were made to send the "Apollo storage container," which included the capsule, to the Kennedy Space Center for an appropriate burial with remnants of the Space Shuttle *Challenger*. However, those preparations halted after a controversy ensued over the historical significance of the Apollo capsule and its possible use in a museum exhibition. Thus, in the summer of 1990, NASA made the decision to keep the Apollo hardware right where it was, in a warehouse at Langley. (The press was allowed to view the remains briefly, in part to confirm that Langley still possessed them.) On 7 November 1990, Langley Director Richard H. Petersen ordered his director of operations "to seal the entrance to the Apollo 204 storage container" and not to break it "without my written approval." For the relevant documentation, see the Apollo 204 Review Board files, Langley Central Files.

Spaceflight Revolution

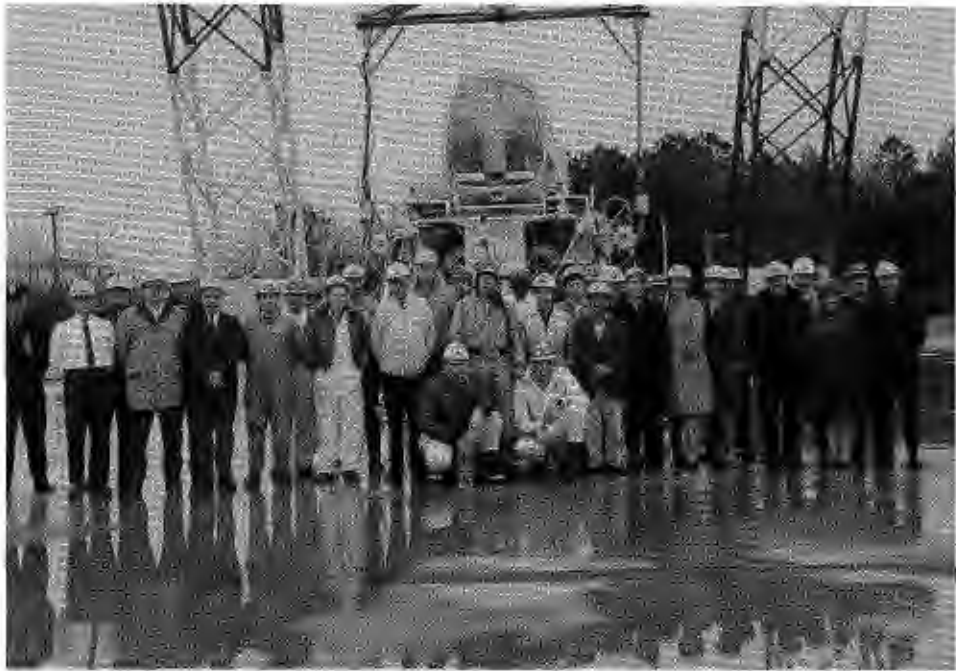

L-67-1697

The Lunar Landing Research Facility staff crowds around Apollo astronaut Neil Armstrong (center) in March 1967, 28 months before he was to become the first human to set foot on the moon.

was behind it. Funding was available. The entire nation mobilized for a common goal." In his opinion, to this day, "the landing on the Moon was undoubtedly mankind's greatest technological achievement and engineering accomplishment. We started essentially from scratch in 1962 and seven years later we were on the Moon. It was a remarkable achievement and remains unsurpassed."⁵⁹

Indeed, Apollo was the crowning achievement of the spaceflight revolution, but it had also served as NASA's only guiding star through nearly all of the 1960s. Apollo shone so spectacularly, few aboard NASA suspected that it would ever dim. Unfortunately, near the end of the program, interest in spaceflight waned, and Apollo's brightness proved to be that of a supernova—dazzling yet brief. Once Apollo had faded, NASA found itself traveling without direction.

The Cortright Synthesis

A new era had already started. All I did was accelerate it. Thompson was wedded to the Langley way of doing things and under Tommy everything would be done well, but done their way and in their good time. All I did was speed it up, I think, what was bound to happen eventually.

—Edgar M. Cortright, Langley director

Cortright came down here with the idea that he knew everything and that he was going to control everything. And this made it very difficult for some of us. Some of us could adjust to it, some of us didn't. I'm one of those who didn't.

—Laurence K. Loftin, Jr., former
Langley director of aeronautics

Every revolution needs its culminating figure, its rationalizer, its Napoleon, who synthesizes chosen elements of the old regime and the revolution to create a new order. Under the firm and confident direction of this dynamic leader, a revolutionary episode calms down, grows structured, becomes what is expected, and establishes norms. The revolution eventually becomes the social and intellectual world in which the new generation lives, awaiting the next major upheaval.

For NASA Ames Research Center in Sunnyvale, California, this culminating—and dominating—figure was Dr. Hans Mark, who succeeded NACA Langley veteran H. Julian “Harvey” Allen as center director in February 1969.¹ For Langley, it was Edgar M. Cortright, who would serve as Langley center director from May 1968 to August 1975. In the first 36 months of his tenure, Cortright put Langley through the most sweeping

Spaceflight Revolution

reorganization in the center's history, be it NACA or NASA. At the end of it, Langley was not the same place it had been. Many of Langley's most vital links to the old culture of NACA research were eliminated or retired. In their place would be established a still very reputable and effective organization but one completely adapted to—even tamed by—the criteria and standards set by the spaceflight revolution.

Putting a comprehensive treatment of the Cortright reorganization and its aftermath at the end of this long study of the spaceflight revolution at Langley, however, would be like piggybacking a complete study of the Napoleonic period on top of a history of the French Revolution from the fall of the Bastille to the coup d'état of 18 Brumaire. The two subjects, although intricately related, need to be treated separately because they are both so vast. In this conclusion, the reader will find discussed only a few of Cortright's changes and their ramifications. I include them to illustrate the dialectical process by which Cortright institutionalized the spaceflight revolution at Langley.

The Stranger

Up to the time of Cortright, whenever a Langley center director left his job, he had been replaced by someone already working at the laboratory. In 1925 upon the resignation of Leigh M. Griffith, young Henry Reid, an electrical engineer who had been working in Langley's instrument research laboratory since 1921, became the engineer in charge. In 1960 upon Reid's long-awaited retirement, Floyd Thompson succeeded him; Thompson had been working at Langley since 1927, and for the past several years he had been Reid's associate director. In office, Thompson immediately faced the problem of naming his own second-in-command. Prior to the spaceflight revolution, the director had always given this position to a close and trusted associate, someone who had been working at Langley for some time. But in the new political and bureaucratic environment of NASA, Thompson hesitated. For over a year, he acted as his own associate director, naming no one to replace him in his old position until he could thoroughly think through the appointment. Cagey Thompson was considering an unprecedented move: the appointment of a non-Langley person, Dr. Ernst Stuhlinger of NASA Marshall Space Flight Center. By naming Stuhlinger, one of von Braun's rocketeers, Thompson would prove to NASA headquarters that he was not so parochial as to only consider Langley researchers for the job. Approached confidentially so that no one at Langley would hear about the offer until it was finalized, Stuhlinger eventually turned down the job. Thus, almost no one heard about—or even now know of—the offer to Stuhlinger. Only after Stuhlinger's refusal did Thompson turn to his talented young friend at Langley, Charles Donlan. By selecting Donlan as

the associate director, according to Langley tradition, Donlan was anointed as Thompson's heir apparent.

Donlan, however, was never given the directorship because the spaceflight revolution would interfere with the tradition of succession at Langley. In March 1968, NASA named not Donlan but Edgar M. Cortright, a virtual stranger to Langley, as the center's new director. Donlan found himself out in the cold; he soon left Langley to serve as deputy associate administrator for manned spaceflight at NASA headquarters. Donlan did this even before Cortright named another outsider, Oran W. Nicks, his former assistant in the office of unmanned spaceflight in Washington, as his associate director. Floyd Thompson made a fuss over none of this; after all, eight years earlier, he had himself tried to bring in Stuhlinger as his number two man. Moreover, Thompson had not retired voluntarily as Langley's director. Instead, NASA headquarters announced unilaterally that "Dr. Floyd L. Thompson, Director of Langley Research Center, will retire when he reaches the age of 70 on November 25, 1968, and that Edgar M. Cortright, Deputy Associate Administrator for Manned Space Flight at NASA Headquarters, will replace him as Director of Langley Center on May 1, 1968." This would enable Thompson, NASA headquarters said, to "utilize a large part of his time on agency-wide planning and evaluation activities." His first extra-Langley task was to be as special consultant to the NASA administrator, Dr. Thomas O. Paine, who in March had succeeded James Webb.²

In certain respects the coming of Cortright was in keeping with the Langley tradition. Like Thompson and Henry Reid, he was an engineer whose first professional employment had been with the NACA. After graduating with a bachelor's degree in aeronautical engineering from Rensselaer Polytechnic Institute in 1947, Cortright had gone to work at the NACA's Lewis laboratory, where he had specialized in the propulsion aerodynamics of supersonic aircraft and guided missiles. While in Cleveland, he had become protégé to Abe Silverstein, Lewis's dynamic associate director. Because Silverstein had worked at Langley from 1929 to 1943, Cortright became familiar with many of the traditions of the NACA's first laboratory.³

In keeping with the spaceflight revolution, however, the coming of Cortright also meant dramatic change. Unlike his two predecessors as director, he had never worked at Langley. Instead of making his way to a high position through leadership in the laboratory's general research program, Cortright had earned the directorship through his project management work at NASA headquarters. When Abe Silverstein came to Washington in the summer of 1958 to prepare for the transition to NASA, he had brought young Cortright with him. For most of his years in Washington, Cortright was associated with the unmanned space program—including the Mariner, Ranger, and Surveyor projects. In that program, his boss was Homer E. Newell, the former chief scientist at NRL. (The core staff of Goddard Space Flight Center had come from NRL, an organization, as we have seen, that would often be at odds with Langley.) In 1963, Cortright became NASA's deputy

Langley Researcher

VOLUME 7, NUMBER 5

LANGLEY RESEARCH CENTER

MARCH 22, 1968

DR. THOMPSON, MR. DONLAN IN TOP NASA POSTS; EDGAR M. CORTRIGHT NAMED NEW LANGLEY DIRECTOR



Edgar M. Cortright



Charles J. Donlan



Dr. Floyd L. Thompson

The National Aeronautics and Space Administration announced this week that Dr. Floyd L. Thompson, Director of its Langley Research Center, will retire when he reaches the age of 70 on November 25, 1968, and that Edgar M. Cortright, Deputy Associate Administrator for Manned Space Flight at NASA Headquarters, will replace him as Director of the Langley Center on May 1, 1968, enabling Dr. Thompson to utilize a large part of his time on agency-wide planning and evaluation activities.

Dr. Thompson will continue to serve as Special Assistant to the Administrator until his retirement and will serve as Consultant to the Administrator on a part-time basis after retirement. On May 1, Charles J. Donlan, Deputy Director of the Langley Research Center, will transfer from the Langley Center to NASA Headquarters to serve as Deputy Associate Administrator for Manned Space Flight (Technical).

Replacing Cortright May 1 as Deputy Associate Administrator for Manned Space Flight will be Charles Mathews, Director, Apollo Applications Program, and formerly Program Manager for Gemini.

The successor to Mathews will be Harold Luskin, former Chief of Advanced Design Engineering of Lockheed-California Company and the former President of the American Institute of Aeronautics and Astronautics. Until May 1, Luskin will serve as Deputy Associate Administrator for Manned Space Flight (Technical).

As Program Manager for Apollo Applications, Luskin will have responsibility for planning and carrying out the utilization of the large Saturn boosters and the Apollo spacecraft systems in the period following the demonstration of the capability of this equipment to land men on the moon and return them safely to earth.

In October 1967, Cortright joined the Office of Manned Space Flight in NASA Headquarters as Deputy Associate Administrator. In this position, he serves as general manager of NASA's program for manned space flight.

Cortright joined the former National Advisory Committee for Aeronautics (predecessor to NASA) as an aeronautical research scientist at the Lewis Flight Propulsion Laboratory (now Lewis Research Center), Cleveland, Ohio, in 1948. From 1949 to 1954, he was head of the Small Supersonic Tunnels Section; from 1954 to 1958, he was Chief of the 8- by 6-foot Supersonic Wind Tunnel Branch. In January 1958, he was appointed Chief of the Plasma Physics Branch.

Upon NASA's creation on October 1, 1958, Cortright became Chief of the Advanced Technology Programs and directed initial formulation of NASA's Meteorological Satellite Program, including Tiros and Nimbus. In February 1960, he became Assistant Director for lunar and planetary programs in the former Office of Space Flight Programs. In this capacity, he directed the plan-

(Continued on page 3)

Langley trumpets a changing of the guard, 22 March 1968.

associate administrator for space sciences and applications. Just before coming to Langley, he became deputy associate director of the Office of Manned Space Flight under George E. Mueller.

Throughout his stay at NASA headquarters, which essentially spanned the era of the spaceflight revolution, Cortright had been involved with the management of an unmanned space program that, with the exception of the Lunar Orbiter project, did not involve Langley. To make matters worse, as far as Langley veterans were concerned, by the mid-1960s, Webb's organization in Washington had strong feelings that Langley had gone its own way too often under Thompson's paternalistic and rather closed NACA style of management. This group within headquarters, which included young Cortright, felt that Langley needed to be brought under tighter central control. When Webb picked Cortright to replace Thompson, he was essentially sending him to the center to ensure such waywardness did not continue—to bring Langley into the fold.

Webb did not draft Cortright for the job; Cortright eagerly applied for it. His last assignment at NASA headquarters, as George Mueller's deputy in the Office of Manned Space Flight, involved "troubleshooting" for the Apollo program; this basically amounted to staying in Washington to stroke the troops during day-to-day meetings at headquarters while the real excitement took place elsewhere. This did not satisfy the ambitious Cortright. "It was awfully hard to come in that late in Apollo and make much of an impact," he remembers. So Cortright went directly to Webb and asked him for the Langley job.* "I wanted my own ship. I always felt that the Center director was absolutely the best job in NASA, and it is." To him, filling Thompson's post would be "a career dream achieved."⁴

Webb gave the forty-five-year-old Cortright the job, apparently with little hesitation. In Cortright's view, Webb had a "gut feeling" that "Langley needed a shot in the arm" and that it had gotten "a little bit sleepy, a little bit complacent. . . . It needed to be brought up to speed." That was his broad charge to him. Webb gave him no specifics about what directorate or division needed attention; he only conveyed the message that Cortright, as a younger person and an outsider, might succeed in "putting more life" into the historic "Mother Langley."⁵

Langley employees were surprised but not shocked upon hearing the news of Cortright's appointment. "My reception was very cordial, very courteous. Well, I say very cordial. It was certainly friendly but maybe a little standoffish because they didn't know me. I didn't know them and I was an unknown factor in the equation to some extent."⁶ The only ones upset by Cortright's arrival were Charles Donlan's many close friends and associates, who believed the job should have been his, but not even they openly showed

* This is Cortright's version. People at Langley heard at the time that Webb, when he was about to leave NASA, asked Cortright what he could do for him. Cortright answered he wanted Langley. There are no authoritative sources to contradict Cortright's version, only hearsay.

Spaceflight Revolution



L-68-2747

The old guard welcomed Cortright to Langley politely but without real enthusiasm. From left to right: Laurence K. Loftin, Jr., Cortright, Charles Donlan, T. Melvin Butler, Clifford Nelson, Eugene Draley, and John Duberg.

their disappointment. Most people gave Cortright the benefit of the doubt. What little they knew about him and his reputation at NASA headquarters gave them reason to believe he was a dynamic leader and high achiever who might be successful in getting Langley more resources and more of NASA's project work. But as we shall see, the latter was not something that the research-minded at Langley wanted to see happen.

When Cortright arrived, he had no detailed master plan for restructuring Langley; thus, the reorganization that followed did not happen overnight. Cortright started his job as Langley center director on 1 May 1968, but he did not have all the major organizational changes formulated and ready to be announced publicly until September 1970. That is not to say that he did not hit the ground running. A dynamic man with tremendous self-confidence, Cortright believed that his project management experience at NASA headquarters had prepared him to take over Langley's direction. On his first day at the center, he met with the senior staff and the mid-level supervisors in the Langley Morale Activities building to discuss his plans for becoming more acquainted with the many aspects of his new position. In his speech to them, he praised the center for its reputation as a "well

The Cortright Synthesis



L-70-6003

On his first day as director (Wednesday, 1 May 1968), Edgar M. Cortright (left) met with the senior staff in the Morale Activities building (below). Many members of the senior staff believed that Cortright had arrived at Langley with preconceived ideas and plans for the center.



Spaceflight Revolution

managed and smoothly operating organization” and expressed “pleasure at the opportunity to work with the Langley staff in moving forward as a team to continue to contribute to the advancement of flight.”⁷ Because he was an outsider and largely unknown to most of the Langley staff, Cortright did what he could to reassure people that he had not come to Langley to make wholesale changes, but suspicions remained. Several members of the senior staff, in particular, worried that Cortright had been sent to Langley for the express purpose of bringing Langley into line under headquarters—a sentiment not far from the truth.

For at least the first year, however, no one at Langley could be sure what Cortright intended. During his first six months, Cortright spent two or three days a week in meetings in which every branch of the center reported on the status of all its facilities and activities. “I had every group at the center come in and brief me in depth on what they were doing so I wouldn’t go off half-cocked. I think I got grudging respect out of that, for taking the time to learn that much about what was going on.” From this thorough review, Cortright formed a better picture of Langley’s strengths and weaknesses. “What I found was a high degree of technical competence. There was hardly anything in aeronautics that Langley was not expert in and didn’t have at least a small pool of experts.” In aeronautics Langley “didn’t have to take second place to anyone in the country in almost any area one could think of.” In space, however, Langley “didn’t have quite that much capability.” The staff had good project management capability from Lunar Orbiter and from Scout, but there were “quite a few areas of space technology that they had very little capability in,” such as electronics (Langley did have electronics under IRD), which Cortright knew was not Langley’s fault because NASA had not given the research center much opportunity to develop these areas.⁸

Overall, Cortright felt that the organization “could stand improvement in terms of the way the authorities were parceled out” inside the center and in the way Langley interacted with NASA headquarters. On both counts, he was a critic of the old NACA way of doing things. The NACA, in his view, was “a very loosely structured research organization where the power resided in the centers, with the center directors and the key researchers.” NACA headquarters was “primarily a bookkeeping type of organization. . . . They were super people at NACA headquarters, starting with Hugh Dryden, but mostly they went in and fought for authorizations and appropriations.” They did not control the centers much, which meant that the centers usually got what the centers wanted. “What the centers wanted to work on, they worked on.”⁹ In other words, the engineers not the managers were in charge.

Under the demands of the spaceflight revolution, NASA had worked to invent a new system. “We did not delegate total management authority to the centers. We kept a rather strong management team in NASA headquarters.” Every project had “program managers” in headquarters, along with a designated project manager at the centers. “When it worked right, those two guys worked hand in glove. When it didn’t work right, frequently the

center directors got in the middle and resisted direct independent interaction between the program office and the project office.” Floyd Thompson had done this more than occasionally, which was one of the main reasons that Cortright was given Thompson’s job. And he was just the man to correct the situation. While working under Homer Newell, he had written the book on the relationship between the program manager and the project manager. Cortright now had the responsibility of leading Langley into a new age in which it would live by the book much more closely than it ever had under Thompson, who in Cortright’s view was “not overly responsive” to following set procedures.¹⁰

Cortright also wanted to keep closer tabs on how research was being managed at Langley. In the old days of the NACA, research was allowed to take its time and run its course, which meant that many efforts were allowed to go on indefinitely awaiting clear results. But times had changed, and the uncertainty of such tortoise-paced fundamental explorations could not be tolerated as in the past. About a year after coming to the center, one meeting in particular cemented Cortright’s opinion of what needed to be done to invigorate the center. For this meeting, he asked the directors of all the divisions to put on the briefing and explain what their programs involved and where the most progress could be made.

That meeting, Cortright remembers, was a “disaster.” First, he discovered to his dismay that some of Langley’s research divisions were working on technology that was “95 percent soft,” meaning that the researchers involved were “squeezing the last ounce out of it at a fair expenditure of time and money.” More disturbing was that “it was very hard to get anyone to tell you what his program was under him. It was just a collection of miscellaneous things which he, the individual, may have known how to justify informally on a one-to-one basis, but was not very articulate at explaining.” This poor performance fixed Cortright’s feeling that Langley was indeed a sleepy place in need of new lifeblood. “I was very disappointed because the directors hadn’t done their homework and gave some very bad presentations. And that set my mind at work that there should be some changes.”¹¹

The Reorganization

One of the goals of the major reorganization of the center that ensued was to make responsibilities and lines of communication clearer within Langley. According to the NACA way, such things were kept informal and rather obscure. Dr. George Lewis, the NACA’s longtime director of research (1919–1947), disliked formal organization charts, once saying to a young Langley industrial engineer interested in developing them that the only thing that boxes were good for was burying people. Henry Reid and Floyd Thompson agreed wholeheartedly with Lewis. The best way to set up an organization was to make things very fluid so that “shadow organizations”

Spaceflight Revolution

could cut horizontally through the formal boundaries. Such an organization also made it hard for outsiders to know exactly what was going on inside the laboratory, thereby making it harder for them to exploit or manipulate its resources. Such thinking resulted in Floyd Thompson's creation of the Groups 1, 2, and 3 organization, which made it impossible to tell the players inside them without a scorecard.

Ed Cortright wanted none of this. In his own words, he was always "180 degrees opposite" from Thompson's shell game. Instead, he thought that a center director should "show everything and everyone, right up to the administrator, exactly how you were organized and everything you were doing." In other words, "total display" was his policy. Organization charts should be simple and obviously understandable, with "a good person in every box." Reporting procedures should be equally clear so that no surprises lurked in the wings. "If we were screwing up someplace, we'd learn it as we were going along—not at the end of the project when something bad has happened and a [government auditor] comes back and says that we've misperformed." At NASA headquarters earlier in the 1960s, Cortright had set up a reporting system for budgets and projects that guaranteed such total display. With the same bureaucratic purposes in mind, Cortright now set out to reorganize Langley and its reporting procedures. "We spent a lot of time putting together our presentations every year, of every project, every program area, with pictures and charts to show exactly where the money was going, how it was being spent."¹² Not everyone at Langley liked such visibility, and some may not have abided by it faithfully, but by the early 1970s, it had become standard at the center. Those people who did not like it "lumped it."

By the end of 1969, Cortright had bided his time long enough; he was ready to carry out the reorganization that had been germinating in his mind since he arrived. In typical Cortright fashion, he brought those who would be most affected by the changes into the process of making them so that they would feel that they had at least a part in determining the course of their own future. "I gave the problem to my directors," whether they liked it or not. He said to them, "Look, this is roughly what I want, and I'm not going to tell you how to do it." The only thing that he specified was that he did want basic changes, because "you get comfortable with your mistakes," and he wanted opportunities made "for creative young people to get a chance to lead."¹³

In the director's main conference room—the "Brown Room" in the Administration building, which was next to Cortright's own office—a small task force made up of the directors and a few handpicked staff assistants, themselves mostly young, orchestrated the reorganization that the spaceflight revolution had made inevitable. On a large mahogany conference table, this task force laid out big sheets of paper and went to work reorganizing the center and everything and everyone who belonged to it. As the directors brought in their ideas and plans, the task force coordinated and massaged

them, keeping Cortright's agenda foremost in mind. When it was all done, in the summer of 1970, between 80 and 90 percent of all the supervisory positions at Langley had new faces in them. A few of the old supervisors left NASA through early retirements; some did not retire but became consultants on salary out of the line of command; most were shuffled into new positions and into new organizations. Only the people who really did not like where this rearranging landed them left.

On 24 September 1970, after months of planning, Cortright's office distributed a large 79-page report to all center employees. It was entitled "Reorganization of Langley Research Center." The report detailed all the organizational changes and provided charts outlining the new overall structure of the center. On its green-colored cover, Cortright explained the report's purpose and immediate history: "Several weeks ago I submitted proposals for the reorganization of Langley Research Center to the Administrator [Dr. Thomas O. Paine] and the Office of Advanced Research and Technology for review and consideration. These proposals have now been approved by Headquarters, and the organizational and personnel changes will be made *effective October 4, 1970.*"¹⁴ Whether Cortright was aware of it or not—and no evidence exists to indicate that he was—4 October was the 13th anniversary of Sputnik. To Cortright, the day was just the start of a new fiscal year. (Coincidentally, or perhaps as part of some underlying pattern in the unfolding of revolutions, the birth of the Napoleonic Code in 1802 dates from almost exactly 13 years after the outbreak of the French Revolution.)

In his letter to Administrator Paine, the contents of which he reviewed in the "Green Paper" report, Cortright stated that "the proposed reorganization would accomplish a number of important steps toward effective prosecution of the projected research program of this Center during the coming decade." He then outlined the six principal advantages of the realignment: first, each of the major areas of research responsibility at the center would have a clearer "organizational focus"; second, all emerging R&D responsibilities would be recognized organizationally; third, new supervisory assignments would be tailored to the future opportunities for the center; fourth, personnel and facilities working on closely related problems would be more efficiently integrated; fifth, the center would strengthen its effort on institutional problems and work more effectively with NASA headquarters; and sixth, technical and administrative support of the research effort would be improved. More specifically, the reorganization would result in better integration of programs; greater stimulation of new program efforts as well as the enhanced development of supervisory personnel; more efficient use of manpower, equipment, and materials; and better interface between the center and other organizations.¹⁵

The new organization consisted of four major research directorates: Electronics, Structures, Aeronautics, and Space, thus eliminating Thompson's mysterious Groups 1, 2, and 3. Supporting these four were two other

Spaceflight Revolution

directorates: Systems Engineering and Operations, and Administration. In addition, one other directorate was formed for center development. This final directorate, first headed by Gene Draley and later by Langley veteran T. Melvin Butler,* was to report directly to the center director on matters that encompassed the interest of all or most of the other directorates, such as safety, reliability, and quality assurance.

Without a doubt, the overall layout was much cleaner and clearer than any during Floyd Thompson's term as director. Every aspect of the center that could be rationalized was rationalized. The reorganization drew a clear line between aeronautics and space. Aeronautics was split into three basic research divisions: one for low-speed aircraft, one for high-speed aircraft, and one for hypersonic vehicles, with two additional divisions focusing on advanced technology transports (most notably the SST, which was not canceled until the following year) and on the operation of flight research vehicles. The Structures Directorate also divided neatly into three divisions: loads, structures, and materials. Even after the reorganization, directors and division heads still exercised some crossover responsibilities but not nearly as many as before.

In addition, at Cortright's specific request, the new organization made room for and focused some of the center's newest R&D interests. Electronics, as Cortright had noted in his earliest staff briefings, needed beefing up, so it became its own directorate, with four divisions. Inside the Space Directorate, a new division devoted to the study of environmental and space sciences was formed. This represented a new focus of interest at Langley, one stimulated in large part by the growing international interest in the problems of environmental pollution and energy consumption. Under the direction of Cortright, who considered himself a pragmatic environmentalist, the atmospheric sciences ultimately proved to be one of the center's most productive and worthwhile areas of research.¹⁶

Another noteworthy item on the organization chart was the Viking Project Office. The goal of Project Viking was to land scientific payloads on Mars; this mission would be achieved in 1976. In December 1968, just a few months after Cortright took office, NASA gave Langley the overall responsibility for managing the project. The assignment made sense given Langley's management of the tremendously successful Lunar Orbiter project and Cortright's own experience in project management and in the OSSA, where he had been the first to propose a *manned* Mars mission. In a sense, Viking came to Langley with Cortright, and it went where he did even after it came to Langley. As can be seen in the 4 October 1970 organization chart, the Viking Project Office reported directly to Cortright. No one else, no other box on the chart, intervened. Before the reorganization, the Viking office was in the Office for Flight Projects, which meant an assistant

* Butler, 30 years previously, had been the young industrial engineer whom NACA Director of Research George Lewis had scolded for wanting to formalize Langley's organization charts.

NASA LANGLEY RESEARCH CENTER

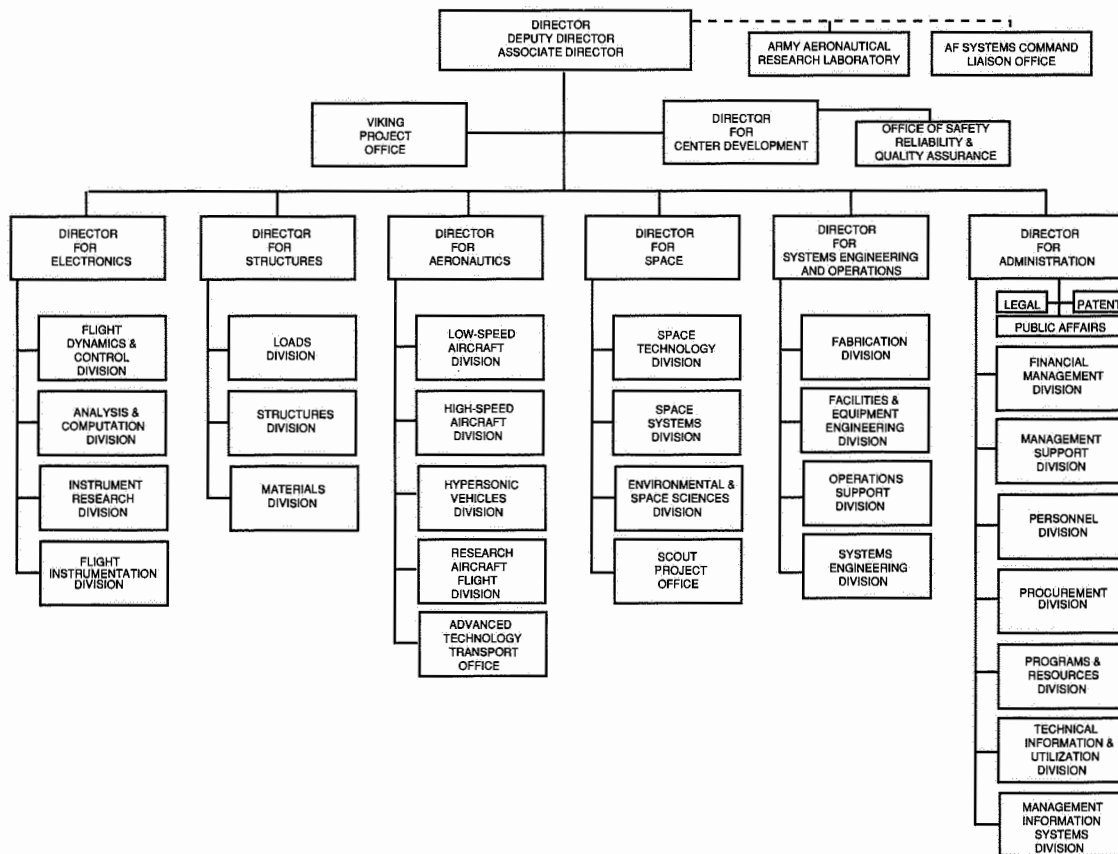

Organization chart of NASA Langley Research Center, effective 4 October 1970.

Spaceflight Revolution



L-70-7351

Reaching Mars with just an unmanned spacecraft meant overcoming engineering challenges greater in some respects than those posed by Apollo. Above, a scale model of the Viking Lander is tested in a Langley wind tunnel in 1970.

director intervened between Viking managers and Cortright. But Viking was Cortright's baby, and with the reorganization he made sure it was pampered. As the Green Paper makes clear, "The Viking Project Office reports to the Center Director and thus occupies a unique position at the Center. This change recognizes the fact that Viking has the highest priority of any single undertaking at the Center and that authority has been delegated to the Viking Project Manager [James Martin] to exercise necessary direction and control over Center personnel who have been committed to the support of Viking within the research and engineering divisions." Such was not the case for the only other major project office at Langley in 1970—Scout—which was still within a larger directorate.¹⁷

This clear preference for Project Viking disturbed several Langley researchers who feared that the big and virtually independent project office would dominate the general research programs. They worried that Viking would influence the center to a greater extent than Project Apollo had in the 1960s. Some feared a "Viking raid," and justifiably so.

Cortright was enthusiastically committed to Viking; by his own admission, it "probably took half my time as director." With his help, the project office built up a full-time staff of more than 250. Supporting them were an equal number of employees in systems engineering, the shops, and in administration. This did cause real problems at Langley. "The researchers felt I gave too much of my time to Viking and that it got too many resources. Some even felt that it split the center. But my philosophy was simple. We

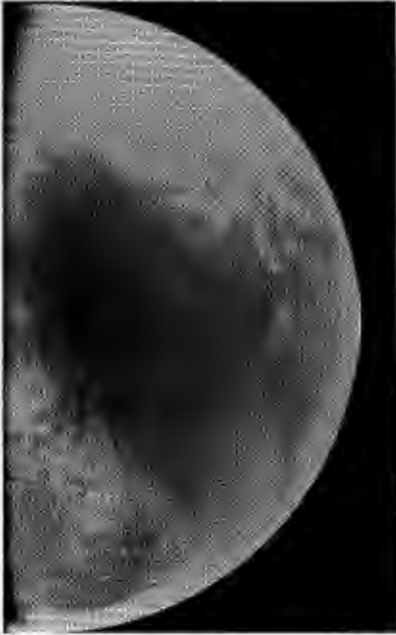

Left, a Viking Orbiter 1 photo of the mysterious "Red Planet" taken in June 1976. In September 1976, the camera aboard Viking Lander 2 (below) shows a boulder-strewn field reaching to the Martian horizon approximately 2 miles away.



Spaceflight Revolution

had Viking. We had to make it succeed, period. There was no choice but to do it properly. And it did succeed, magnificently. It was the highlight of the whole space program, as far as I am concerned. Two orbiters around Mars; two landers on Mars. They all operated the way they were supposed to do. I never would have expected, in my fondest dreams, that they would have been that successful. . . . If anyone ever thought [Langley] was a sleepy center, they sure didn't while Viking was going on or when it succeeded."¹⁸

Viking concerned researchers, but nothing upset them as much as the personal trauma of leaving old and comfortable jobs, moving into new and unknown ones, and perhaps even facing retirement. In concluding his executive summary of the contents of the reorganization report, Cortright stated: "It is realized that the changes outlined herein affect a large number of employees, many of whom will be relocated and working under new supervision. During the initial transition stages, some inconveniences will be experienced. This is to be expected and is a normal outgrowth of reorganization. However, I believe that the immediate and long-range future of Langley Research Center is of prime concern to all of us, and I feel confident that all supervisors and employees will make every effort to facilitate the transition."¹⁹

Any executive officer wants to put together his own team of subordinates, and Cortright was certainly no exception. Long before the reorganization, he had made it clear that he would clean house. For example, when Donlan left Langley for Washington in early 1968 after being bypassed, Floyd Thompson had chosen 51-year-old Dr. John E. Duberg, a structures expert and Langley veteran since 1943, as the acting associate director. Thompson believed that Duberg should stay on as Cortright's associate director because he was just the person who could help a stranger learn everything he needed to know about Langley. Unfortunately for Duberg, Cortright came to realize that Duberg "liked the center the way it was," which marked him in Cortright's mind as "inflexible."²⁰ Cortright eventually took him out of the post and made him chief scientist, a position in which Duberg performed well.*

In truth, Duberg just was not the kind of number two man Cortright wanted. He was looking for "a hard-nose driver who will implement and follow through." In Cortright's view, his own strongest suit had always been "understanding what needs to be done, being able to put teams together to do it, and providing the leadership, with the correct policies and decisions." He was not terribly good, however, at stepping on toes or being ruthless about getting things done; he was "too soft for that." For the "tough follow-through," he needed someone else—a "hard-nose" deputy.²¹

As part of the September 1970 reorganization, Cortright found his man, Oran W. Nicks, the acting associate administrator of the OART at NASA

* Before becoming chief scientist, Duberg served a short time as acting director for center development, succeeding Eugene Draley, who wanted no part of his new job under the Cortright reorganization but stayed on until he died of cancer.



L-70-176

John E. Duberg (left) became Langley's chief scientist after serving briefly as the associate director for Edgar M. Cortright (right). The man in the middle is George M. Low, former head of the Office of Manned Spaceflight at NASA headquarters. Low, at the time of this photo, was serving as acting NASA administrator following Thomas O. Paine's resignation in September 1970.

headquarters. His choice was not a popular one at Langley, to put it mildly, in large part because Langley employees were just not used to having such a gunslinging honcho around. Thompson had been a tough number two for Henry Reid, and Donlan had been tough enough for Thompson, but no one ever cut quite as sharply into the flesh of employees as Nicks. This was especially hard to take from someone who did not know Langley. Like Cortright, Nicks had spent all his time up to then at NASA headquarters and mostly in the management of the space sciences arena, and unlike Cortright, he did not have the time to acquaint himself with the center, or vice-versa, before launching into action. Even Cortright admits in retrospect that "people either loved him or hated him, and there wasn't too much in between. He did step on toes. He was impatient with inaction, and research centers don't normally leap into action every time you suggest something."²²

The person who felt the bite of the reorganization and Cortright's hard-nose deputy the most was Laurence K. Loftin, Jr., the sage head of Group 3 and John Stack's successor as head of aeronautical research at the center. Loftin survived the reorganization and was made director of the Office of

Langley Researcher

VOLUME 9, NUMBER 20

LANGLEY RESEARCH CENTER

OCTOBER 2, 1970



O. W. Nicks

L. K. Loftin

C. H. Nelson

G. B. Graves

G. W. Brooks



P. J. Crain

T. M. Butler

E. C. Draley

AWARDS CEREMONY OCT. 14



AWARDS CEREMONY SPEAKER: Neil Armstrong, Commander of the Apollo 11 moon mission, will be guest speaker at the Center's Annual Awards Ceremony which will be held October 14 at 1:30 p.m. in the NASA Hangar, Building 1244. Each year the Center sets aside a special day in Oct. for purposes of presenting length of service awards to employees and of recognizing individuals and groups at Langley for outstanding achievements which they have made toward realizing the mission of the Center and of NASA.

MAJOR ORGANIZATIONAL CHANGES ANNOUNCED; EFFECTIVE OCTOBER 4

Major changes in the Langley Research Center's organization, which will become effective October 4, have been announced by Director Edgar M. Cortright.

"This reorganization, which is keyed to the future," Cortright said, "is designed with several important objectives in mind. We are consolidating our research talents and focusing them on NASA's roles and missions for the 1970's. We are giving increased attention to the future growth of the Langley Research Center and to its relationships with other organizations. And we are moving some of our most promising young men into positions of management responsibility where they can exercise research leadership."

Four major research directorates are being established in Aeronautics, Space, Electronics, and Structures. They will be headed by Laurence K. Loftin, Jr., Director for Aeronautics; Clifford H. Nelson, Director for Space; George B. Graves, Jr., Director for Electronics; and Dr. George W. Brooks, Director for Structures.

The four research directorates will be supported by three Center-wide directorates in the areas of Systems Engineering and Operation, Administration, and Center Development. Percy J. Crain will be Director for Systems Engineering; T. Melvin Butler, Director for Administration; and Eugene C. Draley, Director for Center Development.

Oran W. Nicks, Associate Administrator for Advanced Research and Technology (Acting), NASA Headquarters, will join the Center as Deputy Director in early November.

In a meeting with Langley senior staff officials, Cortright outlined some of the future NASA goals with which the Center is closely identified.

These include an expanded aeronautics program with increased emphasis on civil aircraft; a new era of manned

(Continued on page 5)

Cortright unveils his sweeping reorganization.

Aeronautics, but he did not last long. Loftin and Cortright represented different philosophies about research and how it could best be accomplished. Loftin had gone along grudgingly with the spaceflight revolution and had played a prominent role in both the early planning for Apollo and the space station. In this regard, he was typical of many of the former NACA researchers, but his heart had always remained true to airplanes and the golden years of NACA aerodynamic research. In the twilight of his career, he was not inclined to bow to Cortright's plans for Langley—and he was even less inclined to tolerate Oran Nicks, whose technical abilities he did not respect.

In June 1971, Cortright replaced Loftin, who moved to a special assignment in the Office of the Assistant Secretary for the U.S. Air Force.²³ Although the outward appearance of Loftin's job change may have looked normal, Loftin in fact felt he had been fired. Cortright exacerbated the problem at the center when he gave Loftin's old job temporarily to Nicks. This lasted for only three months, until September, when Robert Bower, director of advanced development for Grumman Aerospace Corporation in Bethpage, New York (and Cortright's college fraternity brother), replaced him.²⁴ Unfortunately, Bower proved no more popular at Langley than Nicks.

Part of what inspired the reorganization was Cortright's desire for a youth movement. "I wanted more youth," Cortright remembers. "I wanted people who had been in the same job for twenty years to move and do something a little different. . . . That's what I felt my charter was and I felt after that first year of studying the center and its people that it was justified." During Cortright's apprenticeship at NASA in the early 1960s, Abe Silverstein had told him, "You've got to keep the new blood coming in at the bottom all the time. If not, you have big gaps in your management later on." Cortright launched an aggressive recruitment campaign at the same time he was encouraging some of the older employees to retire early. He did this in the face of rather significant manpower reductions NASA-wide. Even the heads of the directorates had to go out and give talks at some of the major colleges and universities to recruit talented graduates. Cortright himself went to Rensselaer, his alma mater, and to the California Institute of Technology (Caltech), which he knew well from his days at NASA headquarters when he monitored studies being done at JPL.²⁵

Cortright changed Langley's recruitment policy. He found by asking the center's personnel department that Langley had been recruiting in the 1960s almost exclusively from a handful of schools, notably Virginia Polytechnic Institute and State University, North Carolina State University, and Georgia Institute of Technology. When he asked why that was the case, personnel officer E. Townsend Johnson, Jr., replied, "Well, Mr. Cortright, we're sort of partial to southern boys." That displeased Cortright, and rightfully so, given the extent to which NACA Langley in the early years had built its talented staff on young people from northeastern and midwestern schools.

Spaceflight Revolution

Cortright insisted on a nationwide search from then until the time he left in 1975.²⁶

Cortright's youth movement was not designed just to fill slots at the bottom of the organization; he also wanted to give younger people the chance to take on additional responsibility and assume leadership positions. To make room for the new people, however, Langley needed to get rid of some of the old. As suggested earlier, Cortright asked for early retirements. A number of senior people felt that if anyone had to go because of the manpower reductions, it ought to be them because they already had enjoyed good careers and should give younger people a chance. These younger people moving up, of course, were happy with the reorganization and provided Cortright with a solid base of support lasting throughout his stay at Langley. Other senior employees, however, became dissatisfied because of Cortright's downscaling of many of the highest civil service salaries at the center. Instead of trying to get as much as he could for his employees, as Thompson had always done, Cortright felt that researchers, no matter how many years of service, should not make more money than the boss.

One group that strongly supported Cortright was the staff toiling in the shops. For them, Cortright rehabilitated facilities to provide better working conditions and, most importantly, air conditioning for the hot and humid Tidewater summers. In large buildings like the huge West Area airplane hangar where air conditioning was impractical, he found enough money to install large fans that hung down from the ceiling and blew cool air on the mechanics and other workers. "Boy, these shop people were my friends from then on," Cortright is proud to say. "And when I retired, they wrote in their shop news that they thought it was unfortunate that the best director they'd ever had had seen fit to retire. . . . I loved those folks. They're the salt of the earth. And I wasn't going to have them working in sweat-shop conditions while all the engineers sat in air conditioning."²⁷

Cortright did other things to build support for his programs. He initiated the practice of giving an annual "state of the center" address, an affair that had no precedent at Langley. "I was a big one for getting people on my side and pumped up," he states. "Langley did so many great things before I got there under Reid and Thompson, that I just wanted to get more of the same. I didn't particularly want to do any better than they did, just to make sure that I did that well, at least." Besides giving this formal overview of the center's current programs and future directions to the Langley employees, Cortright also presented a simplified version of his state of the center address to the employees' spouses. "I gave them about an hour and a half lecture on what the center was doing, why their husbands were coming home late, and what they were accomplishing. That 'coffee and briefing program' worked out real well. It was just part of my style."²⁸

Cortright also moved to stimulate NASA's popular appeal in the community at large by creating an official NASA Visitors' Center, which opened on site at the center in 1971. Such an attraction contrasted sharply with

the old NACA days prior to the spaceflight revolution when the low-key Langley installation was largely invisible to the American public. The leaders of the NACA wanted to keep it that way, but Cortright, following his philosophy of total display, wanted the center opened to visitors—as many of them as would come. “I built the Visitors’ Center. I initiated a major program to communicate the good works of the lab. I got headquarters’ approval for it and we designed it internally, put up all the displays, and opened it up in less than two years’ time. It became the place for having outside groups and hosting receptions.” (Axel Mattson, Langley’s former secret agent in Houston, actually put the visitors’ center together, along with many of its exhibits.) In fact, until its official closing in 1992 and its move to the multimillion-dollar Virginia Air and Space Center on the riverfront in downtown Hampton, this small visitors’ center on site at Langley Research Center attracted (at least according to NASA statistics) more tourists than any other single attraction on the Peninsula, which includes the many historic and entertaining sites in the Jamestown-Williamsburg-Yorktown triangle.²⁹

In a similar vein, Cortright brought Langley and its surrounding community together by joining with the city of Hampton in the building of a unique steam-generating trash burner. “We saw where we could burn trash and get all of Langley Field’s steam requirement and help solve the landfill problem.” Put into operation in 1978, this unique facility worked well except for the release of some nitrogen oxides into the air, a problem that the plant engineers eventually solved. The incinerator, which remains in operation to this day, is a testimony to the kind of community program that Cortright sponsored.³⁰

New Directions

Ed Cortright was not an unpopular center director. Nor was he unaccomplished. During his seven years at the center, Langley again built a solid record of R&D achievements.* Topping the list, of course, were the successful landings of the Viking spacecraft, Cortright’s pride and joy, on Mars in 1976. Nothing in the history of space exploration, except perhaps the manned lunar landing, was a more amazing feat or more difficult to carry out. Under Langley’s expert project management and Cortright’s general oversight, Viking accomplished its mission almost flawlessly.³¹

One of the technological developments that had made the spaceflight revolution possible was the arrival of powerful new computers with new integrated circuitry. Langley had made good use of this new technology

* After Langley, Cortright moved to executive jobs in industry, first with a \$4-billion glass, plastics, and paperboard packaging company in Owen, Illinois, and then as president of Lockheed’s California company.

Spaceflight Revolution

through Paul Fuhrmeister's ACD, but little had been done programmatically during Floyd Thompson's term as director to formalize and consolidate the opportunities made possible by the development of new electronic capabilities. During Cortright's directorship, Langley's computational skills grew much more sophisticated and organized. Early in his term as director, he sponsored the development of the Institute for Computer Applications in Science and Engineering (ICASE) at the center, which enabled leading professors from around the world to use Langley's Star computer to explore ways of applying their mathematical abilities to the development of new aerospace-related technologies. At about the same time, Langley's computational specialists refined a system called "NASTRAN," which stood for NASA Structural Analysis. This innovative computer system, first conceived at NASA Goddard in the mid-1960s, expedited analysis of many types of structures, including large launch vehicles, aircraft, bridges, and even automobiles. As part of the Cortright reorganization, a NASTRAN Systems Management Office evolved inside the Structures Division of the Structures Directorate. The office continued until 1978.³²

Cortright sponsored the development of a computer program that was not as successful—IPAD, or the Integrated Program for Aerospace-Vehicle Design. IPAD engineers were to help optimize aircraft design by creating interactive computer programs relating aerodynamics, propulsion, and structures. The computer program was to be set up with subroutines that would interact through a master central computer. At the master computer, in Cortright's words, "a group of whizzes can design airplanes in a quarter of the time" that it normally took. Ultimately, IPAD would give Langley researchers important insights into such questions as how a change in wing shape would affect the weight of an aircraft or how changing engine placement would influence the craft's aerodynamics.³³

Unfortunately, the optimizing of an aircraft through computers was not an easy matter. Moreover, veteran Langley researchers were not accustomed to being put into the role of actual aircraft designers. By formal NACA policy, researchers were to provide the fundamental information that aircraft designers in industry would need to do their jobs; they were not to design particular airplanes. At senior staff meetings in the early 1970s, Cortright had it "thrown" at him that "we were not a design center" but a place where researchers worked on the problems that those who were designing would encounter. Old-timers like Larry Loftin and NACA veteran and assistant director of the Structures Directorate Richard Heldenfels warned Cortright about IPAD: "That's too elaborate. The companies design; we do basic research." To which Cortright replied, "Well, how do you know you're doing the right basic research if you don't know anything about design? And who is going to do this type of advanced thinking of getting computers to play with each other?" After all, at that time computers were just becoming important in the nation's research centers.³⁴

In spite of the resistance from his senior aerodynamicists (who argued that they indeed *did* know a lot about design *because* they conducted fundamental research), Cortright went ahead with IPAD and eventually contracted Boeing for the system for just under \$40 million. IPAD never achieved everything it set out to do, partly because its original goals were so elaborate, and NASA eventually canceled it when further developments in computer technology, including the development of personal computers (PCs) and individual work stations, made IPAD obsolete. Still, IPAD did have some positive results: it taught engineers in the aircraft industry and NASA how to begin conceptualizing an integrated aircraft design.

A more noteworthy Cortright program that was to incorporate new computational capabilities was the Terminal Configured Vehicle and Avionics (TCVA) program, which NASA co-sponsored with the FAA.* In 1973, NASA bought Boeing's 737-100 prototype, a twin-jet standard-body airliner, at a cost of only \$2.2 million (the market value of a used 737 in 1972 was about \$3.5 million) and outfitted the plane for research. The goal of the TCVA program was "to provide improvements in the airborne systems (avionics and air vehicle) and operational flight procedures for reducing approach and landing accidents, reducing weather minima, increasing air traffic controller productivity and airport and airway capacity, saving fuel by more efficient terminal area operations, and reducing noise by operational procedures." More specifically, the program was to investigate the best approaches of airliners for noise abatement and improved airport acceptance rates, cockpit displays of traffic information, and computer-aided navigation for improved fuel efficiency and closer spacing of aircraft landings. Other experiments eventually carried out as part of the program explored such things as high-speed runway turnoffs and use of the new microwave landing system that the FAA was developing.³⁵

In summary, the task of the TCVA program was to improve air operations in crowded airport areas, which was a goal in some ways as formidable (and certainly as worthwhile) as landing humans on the moon. As this program evolved, TCVA became concerned with the quest for "the cockpit of the future." This cockpit would incorporate the most advanced digital avionics, a subfield that proved to be among the most ambitious aeronautical applications of computer power. The program also was one way for the center to stay involved with technologies relevant to the operation of the supersonic transport, even after Congress's cancellation of the SST in 1971. In particular, TCVA funding allowed NASA researchers to continue investigating the advanced digital electronic displays and automatic guidance and control systems that Boeing, the former SST prime contractor, had been considering for its supersonic airliner.

* The word "Avionics" was later dropped, leaving the acronym TCV. In 1982 the entire name was changed to the Advanced Transport Operating System, or ATOPS program.

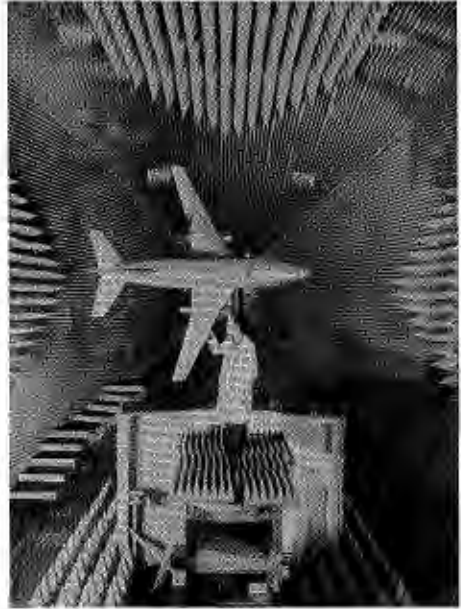

A 1/11-scale model of the 737 airplane is prepared for testing in Langley's Anechoic Antenna Test Facility as part of an effort to develop a collision avoidance system for commercial airliners.

"I got the center into avionics," Cortright claims with pride, "which was totally new." Langley insiders, however, argue that veteran NACA/NASA test pilot John P. "Jack" Reeder and other researchers actually deserve the credit. Whoever was most responsible, the results were impressive, not just for Langley, which became perhaps NASA's foremost research center specializing in the application of microelectronics to aviation, but also for the FAA and the world of civil aviation. For Boeing specifically, TCVA led to sophisticated avionics systems incorporated into the company's new 757 and 767 jet airliners.³⁶

Cortright also believes that he kept Langley active in supersonic and hypersonic aerodynamics, which were two fields of high-speed performance that had lost national support by the early 1970s. "There was a huge effort to cancel hypersonics," he recalls, "but I fought for it all the eight years I was here, and kept it pretty much alive." The same was true for supersonics, which became something of a dirty word around the country following the controversies over sonic booms, noise, and environmental pollution, which prompted Congress to kill the national SST program in 1971. "We pushed supersonics even when we were told to drop all of it." In both these cases, Cortright had to back off his philosophy of "total display," because the only way to keep such politically sensitive work going in the early 1970s was by "bootlegging" it. "Sometimes you just have to survive. So we found ways to keep research going—critical research on supersonics and hypersonics—even when Congress wanted anything labeled supersonic transport or the

The Cortright Synthesis



L-84-13,632

Cortright won initial funding in 1975 for what became the National Transonic Facility, but his successor, Donald P. Hearth (director 1975–1985), would spend considerably more time, energy, and money than expected to build the innovative new wind-tunnel design and establish its regular operation. Left, Hearth’s successor, Richard H. Petersen (1985–1991), stands next to a model of the Boeing 767 prototype mounted in the NTF. Below, a tunnel technician checks the nozzles that inject nitrogen gas into the airflow.

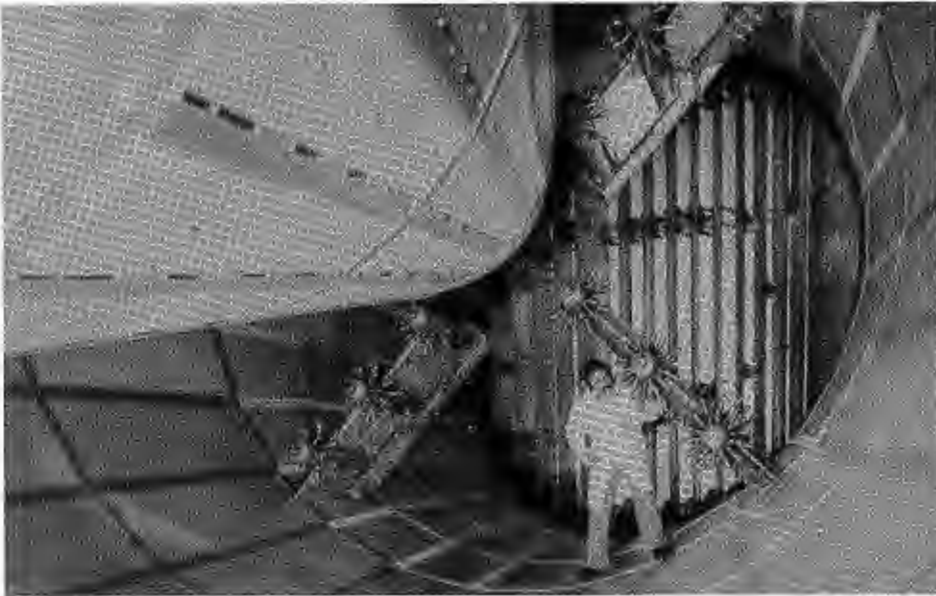

L-83-10,552

Spaceflight Revolution

like, struck.”³⁷ Cortright’s critics, however, underplay the importance of his role in keeping these research areas alive.

Cortright initiated one last project before leaving office in 1975, and this project proved to be critical to Langley’s future: he won NASA’s approval for \$250,000 to build a small pilot facility to prove the feasibility of an in-house concept for a large cryogenic, high Reynolds number wind tunnel. The pilot facility did prove the large tunnel feasible. In 1983 after a long and tortuous developmental period under Cortright’s successor, Donald P. Hearth, this major new facility, the National Transonic Facility (NTF or “The Big Cold One”), opened at Langley to rave reviews, not to mention the audible sighs of relief.³⁸

Critique from the Old Guard

Not everyone was happy with the Cortright reorganization or with the way the spaceflight revolution had been changing the character of Langley Research Center. Many of these critics were members of the old guard from the days of the NACA when the engineers were in charge and fundamental research was their bread and butter. This group was concerned that NASA Langley was heading in a dangerous direction: toward project management work, toward bureaucracy, toward contracting out, and toward less in-house capability. Some of the disenchanted were so frustrated and depressed by the changes taking place around them that they resigned and moved to new jobs or retired. Others stayed on to fight for their vision of Langley’s future.

To nurture communication among his supervisory personnel, Ed Cortright had initiated the practice of holding brief “retreats” from the center. The first of these included three dozen people and took place in the summer of 1969 at Airlie House, a quiet resort lodge in the mountains of western Virginia. A second and third retreat followed at Airlie in 1970 and 1971, followed by annual retreats to Williamsburg, Virginia, which was much closer to Langley. On these occasions, some of the Langley veterans spoke up and exchanged opinions about the proper balance of research and project work. One of the retreat participants most concerned about the decay of the research effort at Langley was Macon C. Ellis, Jr., head of the MPD Branch, which Cortright would abolish as part of his September 1970 reorganization. (See chapter 5.)

Mike Ellis, however, was unhappy even before the dissolution of the MPD Branch. In January 1969, just months after Cortright took over, Ellis began putting down on paper what he called “Very Rough Thoughts on the Degeneration of Research-Mindedness at Langley and the Need for a ‘Research Renaissance.’” He eventually shared the polished version, “Rough Thoughts on Status and Future of Research at Langley,” with only a few sympathetic colleagues. At the heart of his critique was the rather categorical conclusion that “the Center is no longer research-oriented; it is

project-oriented.” Driven by the urgencies of the space program, Langley management had grown “much more concerned with projects and their problems almost to the exclusion of *concern* and *action* related to the status of our future research.” NASA management was only giving “lip service” to “the concept that projects require a research cadre at the Center to draw upon,” but in reality “most of management’s attention is to projects, taking for granted the necessary input from research people.”³⁹

In his confidential paper, Ellis identified several circumstances and trends that he believed were indicative of what he called “the second-best present position of research.” For instance, “In former years of almost solid research orientation, we had monthly meetings of research ‘committees’ and an overall monthly research-oriented meeting called ‘the department meeting.’” But in recent years, the monthly department meeting had been replaced by “a very large meeting open not only to the research and engineering staffs but to the administrative and technical staffs.” This change has “pulled the level of presentation down to the level of *Scientific American* or even *Life* magazine.” Such a meeting “where most of the scientific flavor is lost” was fine for fiscal and other administrative personnel, but it was “demeaning to research personnel,” especially so when “no alternate forum” for the researchers existed at any level inside the center.⁴⁰

Ellis cited more evidence for the deteriorating status of research at Langley: “Awards and rewards are now being made for lesser and lesser accomplishments” and with “no apparent recognition of the diminution of awards for research.” In Ellis’s opinion, NASA was even giving out some of its exceptional scientific awards for achievements that were “clearly not scientific.” This, he lamented, was “demoralizing to the hardworking successful researcher aspiring to true scientific excellence.” What was worse, NASA management was not keeping up, “even to a cursory degree,” with the details of the various specific research areas, such as his own fields of space science and plasma physics. “How often does management above the division level examine, criticize, and evaluate research activities and objectives,” he asked pointedly, “in areas other than those very close to applied problems?” Furthermore, why was it that in nearly all activities requiring the support of administrative or technical services, “the top priority and attention” always went to the projects? Pointing to two recent cases of personnel transfers “out of research,” Ellis emphasized that the prime reason given by both individuals involved was that “all types of support for research,” especially in terms of help from the shops and from laboratory technicians, have “declined to such a point that research activities do not have management priority.”⁴¹

In October 1969, Ellis sat as a member of a Space Sciences and Technology Steering Committee, which Cortright had put together to evaluate the status of space sciences research at the center. At this meeting, Ellis expressed very strong opinions about the deterioration of the overall status of research at Langley and recommended that Langley’s various efforts in space science be consolidated by creating a new space sciences division.

Spaceflight Revolution

His MPD Branch would become a part of this new division. In a typed statement that he planned to present to the committee's chairman, Herbert A. Wilson, Jr., but apparently never did, Ellis wrote:

It is believed that the Center's reputation as a *Research Center* has eroded considerably over the past 10 years. The trend has been toward a Center primarily concerned with projects and contract administration, with increasingly scattered and smaller groups of research excellence. Good research people, including our brightest young ones, who see the situation going in this direction with no apparent positive action to preserve a strong research role, do not stay. A degenerative process results in which, not only research itself, but projects which depend on the research cadre, may also diminish ultimately leaving only management activities and contract administration. What is needed at this point is a hard examination of the research situation at Langley, and the initiation of positive steps to preserve and upgrade the status of research. To the researcher, the present situation appears to be that leadership of a successful project is the acme of accomplishment at Langley. For equal recognition, research accomplishment must be so truly outstanding and highly visible as to discourage many competent researchers.⁴²

Unfortunately, the ideas Ellis did express on these matters were mostly neglected, or at least he thought so. In a handwritten set of notes to himself dated 10 November 1969 and entitled "So-called Minutes of 10/27/69 Mtg. of Sp. Sci. & Tech. Steer. Comm.," he wrote, "I begin to detect a lack of candor in reporting what *actually* was said in the discussions. There were some very forthright statements made (by MCE among others) that are very much unreported. ["MCE" stands for himself, Macon C. Ellis.] Everybody seems to *see* and *hear* what he *wants* to, regardless of what is presented."⁴³

Ironically, Cortright, in his reorganization the following year, did create an Environmental and Space Sciences Division within the new directorate for space as Ellis had recommended. Mike Ellis, however, would not be a part of the new division, although most of his MPD scientists would. Instead, Ellis became associate chief of the Hypersonic Vehicles Division under John V. Becker—a position that he did not want. As for his ideas on the degeneration of research-mindedness at the center, nothing in the historical record suggests that the Cortright administration tried to reverse the trend by moving away from projects toward basic research as Ellis recommended; the administration seems only to have pushed the center further in the direction of projects.

Another individual who spoke up about the erosion of Langley research was John V. Becker, Ellis's boss both when he worked in the MPD Branch in the Aero-Physics Division and now in his position in the new Hypersonic Vehicles Division. Although Becker had started working in the field of high-speed aerodynamics at NACA Langley under John Stack's tutelage in 1936, he was no dinosaur. When it came to keeping up with the times and adapting to changing circumstances, Becker always proved to be thoughtful,

pragmatic, and adept. He understood NASA's reasons for naming Ed Cortright Langley's new center director. As Becker has written in the notes to his private papers, "to a shrewd aggressive administrator like James E. Webb, who had studied and written on modern management techniques, Langley's director F. L. Thompson and his staff of aging Langley employees must have appeared old-fashioned and in need of managerial rejuvenation. Langley's long-standing division structure established along disciplinary lines and deliberately provided with vague names like 'Full-Scale' or 'Aero-Physics' was an obvious target for change. Thus in 1968 Webb chose a man from his HQ staff, Ed Cortright, to succeed Thompson, passing over Langley heir apparent C. Donlan." In Becker's opinion, Cortright "undoubtedly came with a clear mandate to shake up and modernize the Langley operation."⁴⁴

Becker was one of a small minority of Langley managers who believed that changes were definitely needed. "Communications both within and among the research divisions were clearly inadequate and in fact entirely lacking in many cases," he admitted. "Mechanisms to insure accountability were virtually non-existent at all levels from researchers on up through division offices." What bothered Becker specifically was that researchers in some of the "aging divisions" were pursuing research in areas completely unrelated to NASA's aerospace charter, such as cancer-cell biology, interstellar mechanics, and even personalized rocket propulsion units for U.S. soldiers. In his own division, he saw the need for improvement. Although he had supported the esoteric pursuits of MPD for many years, Becker now felt the branch needed to be discarded so that its staff could move on to more promising research.⁴⁵

The Cortright reorganization was not exactly the change Becker had in mind, however. "After a few months of review Cortright concluded that a part of the research talent should be reorganized into dedicated divisions focusing specifically on the prime NASA systems of the immediate future, i.e., the Space Shuttle and the Space Station." Becker and others on the senior staff, notably Larry Loftin, disagreed with this approach. "Loftin and I argued strongly against Ed's concept of a Space Systems Division." This division was formed by Cortright in 1969 and named the Space Systems Research Division; it was to serve as the lead division for support of NASA's major manned space systems. In Becker's view, "such a management-favored division having the bulk of industry contacts, liberal funding, shop priorities, etc.," would "seriously degrade the disciplinary divisions." Rather than a Space Systems Research Division, Becker and Loftin advocated using ad hoc task groups with memberships drawn as required from the disciplinary divisions; this method had been used by Thompson and others at Langley with great success. Specifically, the duo suggested an ad hoc Shuttle task group to be headed by Becker's longtime associate, NACA veteran Eugene S. Love, then the associate chief of the Aero-Physics Division. In the end, Cortright made Eugene Love the first

Spaceflight Revolution

head of the new Space Systems Research Division, the unit Becker and Loftin had fought against.⁴⁶

Clearly, Cortright was “intent on making large breaks with former Langley practices,” Becker believes. His Space Systems Research Division “soon became the centerpiece” of his new Space Directorate. This directorate included the new Environmental and Space Sciences Division, which Becker also opposed because it was an “obviously earthbound” area of research related to aerospace only through the use of satellite photography and satellite navigational aids. Most of Becker’s former MPD researchers, with the exception of Mike Ellis and a few others, were moved into these two new divisions; the work in these divisions, in Becker’s opinion, fell outside Langley’s essential charter. Most of the other old disciplinary divisions “contributed heavily” to the new nondisciplinary divisions as well; the Applied Materials and Physics Division, the historic PARD, was “virtually wiped out.” “Perhaps to ease the pain Cortright chose to make these reorganization moves piecemeal over a three-year period.”⁴⁷

Although he did not agree with many components of the Cortright reorganization, Becker, like many other Langley employees, eventually made his peace with what appeared to be inevitable. However, this did not stop him from speaking out. Over and above the specific details of the center’s structural reorganization, what concerned Becker most deeply in the late 1960s and early 1970s was the decline of the general research culture at NASA Langley. On 13 March 1970, at the second Airlie House retreat, he presented a stinging appraisal of what had been happening to Langley in the years since Sputnik. This critique captures the essence of how the spaceflight revolution had changed Langley.

Becker began his talk by distinguishing between “research” and “projects.” He defined the former as “the whole spectrum of Langley Research Center activity, basic and applied,” and the latter as “any highly focused ad hoc endeavor, involving usually the development of a flight vehicle system.” He then reviewed the interaction of research and projects during the NACA era. Becker did concede that the entire research program had always been “shaped and characterized by aircraft and missile projects and their demands for R&D.” Langley research (even during the NACA period), although “fundamental” and “basic,” was always meant to be “applied” and “practical.” Indeed, the NACA worked on projects, but these projects were driven by research needs such as the lack of transonic wind-tunnel data, not by operational flight requirements.⁴⁸

After Sputnik such research-related projects continued to be “key factors in NASA research” as evidenced by space projects Fire, RAM, the hypersonic research engine (HRE), the barium cloud experiment, and continued involvement in the development of specific aircraft, including the F-14, the SST, and the V/STOL. “But with NASA came a new type of project involvement: project management,” Becker argued. Because of the spaceflight revolution, Langley became an “operating and management agency

rather than a research agency.” Less than 10 percent of its budget went to in-house use, whereas in-house research received more than 90 percent of NACA funding.⁴⁹

Given the natural diversion of NASA center management’s interests to “the high-dollar areas of project operation rather than research,” it was “remarkable,” in Becker’s view, that “research has continued to survive in this atmosphere to the extent it has.” Nonetheless, despite this tenacious ability to survive, Becker felt that research was “losing its identity in the NASA management/operations jungle.” An increasing number of researchers were saying that “NASA is a management agency and we should be getting into management.” Even their spouses asked, “What projects are you working on?” or “Shouldn’t you get into a project to get ahead?”⁵⁰

In his talk before the senior staff at the Airlie House, Becker made the interesting point that research involvement with projects usually hit a high mark early in the project; as the project progressed, research dropped off significantly, thus leaving only project management. He then cited three examples: the Apollo program, for which the years 1959 to 1961 (before President Kennedy committed the country to the lunar landing) were “the big years from the research view”; the Viking program, which in 1968 occupied eight of his crew in the Aero-Physics Division but in 1970 involved only one; and the proposed manned Mars program, for which, in his opinion, “our principal involvement in research will be over before a project office is set up.” These examples led him to a keen observation: “Any one LaRC [Langley Research Center] project, no matter how large, will provide only a small and short-lived part of the total project stimulus desirable for LaRC research.”⁵¹ Research demanded not more projects but more commitment to the development of a broad spectrum of technical and scientific disciplines.

“Ten percent of Langley research personnel are now in Project Offices,” Becker told his colleagues, which amounted to only the tip of the iceberg given how much additional support projects required. “Much more than 10 percent of Center management is involved due to the heavy concentration of dollars, management problems, and pressure to meet schedules.” Becker wanted to know, “Where will the growth end?” In the eyes of many researchers, Becker advised, project management appears to be “primarily a service function, not a research function.”⁵²

Becker then asked the key question: “Is it desirable for a Research Center to develop and maintain a corps of project management people whose services are available for successive space projects, many of which do not spring from and do not relate strongly to the main research activities of the Center? If it *is* desirable, there must be some clear benefits.” Try as hard as he could, however, Becker could not find any. Did Langley’s management of nonresearch-related projects such as Scout benefit research simply by being close to it, the “benefit of proximity”? It did not, according to Becker. Did projects people return to research after the termination of a project with “recharged interests and new ideas”? Becker saw no evidence of that. Could

Spaceflight Revolution

projects be used as “a haven for research misfits”? Yes, but this was really an organizational disadvantage because it was a quick fix for a problem, not a long-term resolution. Do effective project management practices and techniques “rub off on research and improve it”? No, Becker answered, such methods were “actually incompatible with research.”⁵³

Becker then suggested that project management may simply be the “easy way out for NASA Headquarters.” Those who are responsible for managing a research center like Langley get their “brownie points” for cooperating with NASA headquarters in its pet projects. And given the contemporary social apathy (and even growing antipathy) for basic science and technology, it was easier for NASA to “impress local politicians and public with management of \$800 million” in projects than it was to explain the benefits of basic research to them as the lower-key NACA officials had always done.⁵⁴

Becker’s Airlie House presentation struck a responsive chord with most of the veteran NACA researchers present, and several of them asked him afterward for copies of his talk. Naturally, Cortright and those involved primarily with project management made their counterpoints. These included the notion that Langley needed projects to remain in the public eye. Becker and some of the other skeptics interpreted that to mean that the most important goal was not to keep Langley alive and prosperous doing what it was designed to do best but simply to keep it alive at all costs. Cortright also responded with the suggestion that research division chiefs simply would have to do a better job of “selling” the benefits of research to the center, to NASA headquarters, and to the American public at large. This would make research more competitive with projects and keep it from being pushed aside.⁵⁵

Such was the mindset of the man who synthesized the spaceflight revolution at NASA Langley. Basic research, the NACA’s reason for being, had to be explained not only to the country’s body politic as in the past but also to those leading the organization in which it was done. As NASA Administrator Thomas Paine had been quoted in an August 1969 newspaper article entitled “Future Operation of LRC Assured,” the fate of Langley Research Center “will rise or fall” depending upon the fortunes of the space program.⁵⁶

To John Becker, the administrator’s remark epitomized all that was wrong with NASA’s attitude toward research. In a calculated act of defiance, Becker sent a copy of the newspaper article quoting Paine to Cortright with a two-page “unsolicited opinion.” Becker pointed out to the director that Langley was a research center and, therefore, its fate should not depend on the “uncertain, short-lived projects of the space program.” Becker lamented that “the current movement of Langley to glorify and expand project involvement at the expense of research, if it succeeds eventually in replacing the old research and technology development program, *will* put Langley in the ‘rise or fall’ predicament described by Dr. Paine.” He concluded, “No reply necessary or expected.”⁵⁷

Cortright responded immediately (in what he called an “Unsolicited Reply”) with the single comment that “Paine did *not* make the statement during his talk—if at all.”⁵⁸ This was a rather lame rejoinder to the serious matters raised by Becker’s cutting memo. Cortright, however, would hear such criticisms again. Although he and the other consolidators of the spaceflight revolution would prevail, the fundamental tensions caused by the essential incompatibility of basic research and project management would always remain at Langley. The clarity of purpose that Langley had enjoyed during its history as an NACA laboratory was gone forever.

Epilogue

Either spaceflight will be proven a successful revolution that opened the heavens to human use and habitation, or it will be proven an unsuccessful revolution that demonstrated in its failure the limits of technological advance If spaceflight does fail, its abandonment will represent a technological counterrevolution of great consequence, symbolizing the end of progress as it is understood today.

—William Sims Bainbridge
*The Spaceflight Revolution:
A Sociological Analysis*

America's space program was once a source of pride and inspiration. Now it is a shambles, its mission unclear, and its very existence at hazard.

—Stuart F. Brown
"Space after the Race"

By the early 1970s, the spaceflight revolution was already gasping for breath. Born in the violence of the cold war, driven by the Sputnik hysteria, perverted by the specter of atomic apocalypse, and ultimately fed by the need to demonstrate in some dramatic—maybe even primal or mythic—way the essential superiority of the American democratic system over its supposedly entrenched and black-hearted communist enemies, the U.S. civilian space program of the 1960s represented an extraordinary national movement that could be sustained only for a brief but intense period when Americans were deathly afraid of the end of life as they knew it. Kennedy's moon shot was meant to alleviate deeply embedded fear and paranoia. By design, his Apollo program put America back on course as the world's indisputable technological leader and the guardian of a safer and more hopeful future.

Until the United States beat the Soviets in space and answered the enemy's challenge, nothing dear seemed secure. It did not take a half dozen lunar landings to reassure the American people and the rest of the world

Spaceflight Revolution

of America's virtues; the Apollo 11 mission alone was enough. With the lunar landing accomplished, the country had faced down the rival superpower and had won the space race; the public could feel safe once again. The threshold of terror that our national psyche had crossed through because of Sputnik receded to a more comfortable distance. In turn, the United States no longer felt the need to support the adventurous and expensive space program of the 1960s. That venture cost Americans as much as \$5 billion annually—or 4.5 percent of the national budget per year.¹ The country retreated from NASA's expansive plans for setting off as regular travelers through the Solar System. Instead, the country looked to accomplish other, more earthly objectives. These included ending the war in Vietnam, cleaning up the polluted natural environment, and finding a better way to get along with the communist world through *détente*.² This "new age" agenda moved the American people back to the earth, not away from it, and whether spaceflight enthusiasts realized it or not (and for the most part, they did not), the extraordinary flurry of technological activity to get humans off the planet and on their way to other worlds far, far away was over—at least for the time being, until external circumstances would once again come together to spur the inner disquiet that launches such odysseys.

"In a fundamental way, Apollo was about *leaving*." This is what Apollo 11 astronaut Mike Collins said shortly after the end of the lunar landing program. "It was our first move outward, off the home planet."³ For a variety of reasons, a lot of people had been eager to go. In July 1969, Thomas Paine, the NASA administrator at the time of Apollo 11, predicted that a \$5000 lunar vacation would be available by 1990. A future president, Ronald Reagan, was one of thousands who joined the waiting list in the summer of 1969 for the first commercial flight to the moon. Pan American World Airways actually booked reservations for lunar flights scheduled in the year 2000—plans that today look more than a little premature technologically, not to mention commercially because Pan Am is now defunct.⁴

Apollo may have been about leaving as Collins has suggested, but not everybody wanted to go. In truth, Americans of the 1960s were ambivalent about the moon shot. Not everyone felt the urgency or saw the sense in Jack Kennedy's goal. Many were skeptical or outraged at the billions of dollars spent. Maybe once, only once, did a vast majority of Americans approve of the Apollo program—on 20 July 1969, the day Armstrong and Aldrin stepped onto the Sea of Tranquility. But July 20 was just one day in a very turbulent year. The year 1969 was the time of Woodstock and the Age of Aquarius, the movie *Easy Rider*, the bridge at Chappaquidick, campus unrest, anti-Vietnam War marches, and the trial of the Chicago Seven. Cities still smoldered from race riots.⁵

"I don't know whether it's the noblest expression of the twentieth century or a statement of our lunacy," Norman Mailer thought to himself while watching the first lunar landing from the spectator's gallery at Mission Control and later wrote in his offbeat account of Apollo 11, *Of a Fire on the*

Moon.⁶ Even more offbeat was the declaration made by rock critic Greil Marcus that “Janis Joplin’s new album is more important than landing on the moon.” Others were less impressed. “It means nothing to me,” artist Pablo Picasso said. Some were downright hostile. The historian and social critic Lewis Mumford called the moon landing “a symbolic act of war” by a “megatechnic power system in the lethal grip of the myth of the machine.” He predicted that “the very triumphs of technology” would soon turn “the planet into a lunatic asylum or a crematorium.”⁷ That dire prediction was perhaps misguided in several respects, but it certainly overestimated the passing influence of Apollo.

The year 1969 simply may not have been a good time for bold predictions of any kind. Wernher von Braun, the *deus ex machina* of the Apollo program, predicted that by the year 2000 “we will undoubtedly have a sizable operation on the moon; we will have achieved a manned Mars landing; and it’s entirely possible we will have flown with men to the outer planets.”⁸ “Undoubtedly” and “entirely possible” were phrases that reflected NASA’s wishful thinking but not the present mood of most Americans.

If Apollo was about leaving, the period after Apollo was to be about staying home; that is what the predictors should have been forecasting in 1969. Having visited our nearest neighbor half a dozen times between July 1969 and December 1972, and having brought back all the souvenirs our travel bags could carry, we were ready to return to a more normal routine. On a much larger scale, the American space program seems to have gone through something comparable to the aftermath of a family vacation to the Grand Canyon; it was an exciting and valuable adventure but also an exhausting and expensive trek from which Americans needed to recover.

This was certainly the attitude of the general public and their president. Just a few months after Apollo 11, an opinion poll showed that 50 percent of Americans thought the country should “do less” in space; only 20 percent thought the country should “do more.” As for President Nixon’s view, only four days after flying out to the USS *Hornet* in the middle of the Pacific Ocean to personally welcome back the crew of Apollo 11 from its lunar sojourn, he hit NASA with the first of several sharp blows to its ambitious plans for the future. On 28 July 1969, his director of the Office of Management and Budget, Robert Mayo, sent a letter to Thomas Paine, the NASA administrator who had predicted lunar vacations by 1990; this letter stated that the space program’s budget would be frozen at \$3.5 million for the remainder of Nixon’s term.⁹ A second blow came shortly before Christmas 1969: President Nixon rejected NASA’s appeal for enough additional money to keep production of the Saturn V going. This news devastated NASA’s long-range plans. A few weeks later, buoyed by this victory for fiscal responsibility, Nixon’s budget director along with other members of the White House staff informed NASA that “there is no

Spaceflight Revolution

commitment, implied or otherwise, for development starts for either the space station or the shuttle in FY [fiscal year] '72."¹⁰

Barely a scintilla of hope remained for the continuation of the spaceflight revolution. That small chance was a report that in early 1970 sat on a desk in the White House awaiting a reply. Vice-President Spiro Agnew's Space Task Group had submitted the report to Nixon for consideration in September 1969. The report, issued after a lengthy seven-month study made in response to Nixon's own request for a "definitive recommendation on the direction the U.S. space program should take in the post-Apollo period," called for a bold continuation of the aggressive space program of the 1960s: a permanent lunar base and a space station serviced by a completely reusable space shuttle—technologies long envisioned by the pioneers of space exploration as the springboard to Mars and the other planets.¹¹ The Agnew team's report essentially ratified NASA's own vision of where the space program needed to go after Apollo.¹² But the glimmer of hope associated with the fate of this report was soon squelched. In early March 1970, President Nixon issued a policy statement entitled "The Future of the United States Space Program," which, although conceding that "space activities will be part of our lives for the rest of time," sounded the deathbell of the spaceflight revolution by cautioning that "we must also realize that space expenditures must take their proper place within a rigorous system of national priorities. What we do in space from here on in must become a normal and regular part of our national life and must therefore be planned in conjunction with all of the other undertakings which are also important to us." The country could not afford more "separate leaps" like the moon shot, another "massive concentration of will," or another "crash timetable."¹³ As one scholar who has examined the post-Apollo retrenchment in detail has said, NASA would now "have to get down on the ground and scratch for seed with all the other government chickens."¹⁴ The revolution was over. Times were again to be "normal" and "regular."

Congress agreed with Nixon's conservative space policy, in large part because the country's legislators were in the same stay-at-home mood as the president. With opinion polls clearly demonstrating a declining interest in space (poll data had actually shown a significant decline in support for the space program long before the achievement of the first moon landing), NASA was lucky to win the few political concessions it did in the early 1970s, including the one in the summer of 1970 that ensured just enough funding to launch an orbital workshop called Skylab inside the upper stage of an already assembled Saturn V.¹⁵

By 1971 even NASA leadership was waving a white flag. James Fletcher, who took over as NASA administrator in April 1971, understood when he accepted the Nixon appointment that "there is no way" to do a space station and a space shuttle at the same time.¹⁶ The best NASA could do was to approach its long-term objectives incrementally, by first requesting a shuttle—and not even the fully reusable vehicle it wanted—and later asking

for a space station that the shuttle could eventually service. This made much less sense technologically, but it made sense fiscally and politically, and that was what counted. In early 1972, the year that saw the last two Apollo flights (Apollo 16 and 17), President Nixon finalized the country's retreat from the spaceflight revolution with a key policy decision: the space station was again to be leapfrogged and postponed until some indeterminate time in the future. For the time being, the country indeed would have only a shuttle—and a scaled-down, partially reusable version of the vehicle that NASA really wanted. This way initial development costs could be minimized. The fact that operational costs for such a shuttle would eventually skyrocket was something for a future president and NASA administrator to worry about. Thus, NASA and the space program entered a 20-year period of incremental politics and the less-than-optimum technologies produced by such politics, in which the development of a limited shuttle mission sufficed and the fight to build an affordable (and almost perennially redesigned) space station dragged on.¹⁷ Even though the space budget would approximately double between the early 1970s and the early 1990s, the result would nonetheless be a rather pathetic space exploration program locked in earth orbit. Of the 155 U.S. spacecraft launched between 1984 and 1994, only 7 left earth orbit.¹⁸

One could argue that, even with this reversal of fortune, the spaceflight revolution never really ended—and, for that matter, Americans did not really stay home. *Pioneer 10*, launched in 1972, became the first man-made object to exit the Solar System. In 1976, Viking took our robots to Mars. And beginning in 1977, the Voyager spacecraft began a phenomenal “Grand Tour” of the outer planets. In taking us into earth orbit, even the scaled-down Space Shuttle, which made its first operational flights in 1981, took us someplace we needed to go routinely if we were ever to become real space travelers. Thus, the spaceflight revolution continued, only with a temporarily different emphasis. From this point of view, what Sputnik started was permanent. It was only a matter of time before humankind again spurred ahead on target to some distant star.

A fundamental change in the ulterior makeup of American society and government also survived Apollo, some would say. As historian Walter McDougall has argued in *The Heavens and the Earth: A Political History of the Space Age*, the launch of Sputnik in 1957 gave birth to a state of “perpetual technological revolution” through *technocracy*, which McDougall defines as “the institutionalization of technological change for state purposes, that is, the state-funded and -managed R&D explosion of our time.”¹⁹ Once institutionalized, technocracy would not go away; this is McDougall's message. The Soviet Union was the world's first technocracy, and it would stay in power even if that required murderous purges. The United States was the world's second technocracy, created by Sputnik, and although not a brutal oppressor like Soviet militaristic totalitarianism, America's civilian technocracy, which would stay in power through the federal bureaucracy and

Spaceflight Revolution

military-industrial complex, would eventually prove as oppressive in terms of the social engineering it directed as the Soviet system it was designed to fight. Thus, in McDougall's view, the spaceflight revolution did not end in the early 1970s, and it never will, short of a fundamental spiritual upheaval—a conversion that would place far less faith in the passing material values of scientific and technological progress and more faith in the transcendent. "When that day arrives," McDougall imagines, "the technocratic pump may cavitate, the human heart have a meltdown, and science become again a branch of moral philosophy."²⁰

But nothing about human history is perpetual, and such days of cavitation—or some less cataclysmic version of them—can and do happen. McDougall's controversial book was published in 1985, a year before the *Challenger* accident, four years before Tiananmen Square, six years before the fall of the Berlin Wall and the collapse of the Soviet Union, and nearly a decade before the Republican party regained majority control in the U.S. Congress for the first time since 1954. During the period McDougall was researching and writing his book, President Reagan, the hopeful moon traveler, strongly endorsed the building of Space Station *Freedom*, gave his wholehearted support to the Space Defense Initiative or SDI (better known to its critics as "Star Wars"), and called for the development of a National Aero-Space Plane (NASP), which was a futuristic hypersonic vehicle capable of flying in and out of the atmosphere. It was misnamed by Reagan's speechwriters "The Orient Express," because such a spaceplane might someday be able to fly nonstop from New York to Tokyo in a few hours.²¹ Although NASA had lost many major battles by then, agency leadership still operated in the 1980s according to the momentum model of the 1960s. Because the United States seemed to be locked in mortal competition with intransigent communism, this model deemed it necessary to have an expansive space program doing whatever it took for the country to remain number one technologically.

The ambition of many well-meaning supporters of the space program was, therefore, to secure another dramatic presidential commitment for a bold new initiative. This initiative was on the scale of Kennedy's lunar commitment in May 1961, which energized the American people so successfully, or Reagan's commitment to Space Station *Freedom* in January 1984, which failed to do anything of the sort. Even critical and scholarly observers of the U.S. space program, including those who lamented the bureaucratization of NASA and the devaluation of its technical culture since Apollo, have made that suggestion. For example, political scientist Howard McCurdy, professor of public affairs at American University in Washington, D.C., suggested in his article "The Graying of Space" that NASA could best rejuvenate itself by aiming at a big new goal such as a trip to Mars.²² In essence, however, such suggestions implied that American space policy would be best served if the momentum model could be refueled. This analysis missed the point that the momentum model has actually been

the major reason for the failure of American space policy since Apollo 11 and that it, too, has been the cause for much of the technical decline in the NASA organization. If NASA's long-term competency and productivity in basic R&D are a main concern, U.S. presidents need to stop making such bold pronouncements, not make more of them.

The collapse of the Berlin Wall in 1991 and the fall of the Soviet Union proved, if proof were necessary, that the unimaginable really does happen. In a very short span of time, these megahistorical events, which were certainly in the league of Sputnik in terms of unraveling the expected, pulled the plug on the momentum model that had been driving the American space program since Sputnik. U.S. leadership saw that the ground rules of what had been a space race had changed fundamentally almost overnight. President George Bush appointed Daniel Goldin as the head of NASA in early 1992. Goldin had worked the prior two decades in U.S. weapons factories on top-secret military space hardware projects, but as the NASA administrator he proved so innovative that President Bill Clinton decided to keep him on after the election. Goldin understood that the space program of the mid-1990s and beyond could not operate on the basis of an obsolete world order of fear, violence, and competition with an enemy who was no longer there. The key words for the future were cooperation and international partnerships. The Soviet Union no longer existed; now there was only Russia. The United States would still be concerned about Russian cosmonauts, but not as competitors or as instruments of the Soviet propaganda machine, rather as fellow crew members in an international space program working alongside not just NASA astronauts, but those of Germany, Canada, France, Japan, and other nations. The world had turned topsy-turvy again. Up was down; down was up. Space explorers had to adjust.

The political and technological imperatives that had driven the American space program through its revolutionary period after Sputnik and that had tried with diminishing effectiveness to move it after Apollo had evaporated. With their disappearance, much about the space program had to change. In Goldin's pet phrase, NASA needed to do everything "smaller, faster, cheaper, better."²³ In keeping with tough economic times and the trend toward downsizing in American business and industry, the American space program had to learn how to do more with less. To meet a directive from President Clinton in 1993, NASA moved to "reinvent" itself and find ways to reduce its spending by 30 percent over five years, which resulted in a \$30 billion budget cut. (In contrast, in the summer of 1990, a NASA advisory panel still operating from the momentum model and chaired by systems engineering guru Norman Augustine of the Martin Marietta Corporation, had called for a 10-percent budget increase for NASA each and every year into the early twenty-first century just to meet the "critical national needs" in space.²⁴) The nation would still move boldly out into space, but in cooperation with the rest of the world, not alone, not facing down enemies, and not making great leaps. Instead of placing such a

Spaceflight Revolution

predominant emphasis on government-directed spending, the privatization and commercialization of the enterprise gained momentum. Instead of the prospect of an ever-increasing technocracy, there was a growing possibility that space exploration might move ahead with less overriding government involvement and direction. The U.S. space program would still be part of the total equation of national strength and security, but, because that equation had changed so dramatically with the end of the cold war, NASA had a chance to escape from the old mindset, be much less bureaucratic, return to basic operating principles more like those of the former NACA before Sputnik, and be part of the solution, not part of the problem.

All of this augurs significant and positive change for the American space program and NASA. This may be especially true for NASA Langley Research Center, a place that has done its best, not only to abide by, but to encourage the prevailing momentum model through the 1970s and 1980s, even though it meant the slow but sure dissipation of the traditional research values that had been the creative heart and soul of the center since its formative days in the 1920s under the NACA. Langley, perhaps more than any other NASA facility, needed to move away from the *modus vivendi* of the cold war and refocus on what it has always done best: basic applied research. The cold war, perhaps war of any kind, ultimately used up more good ideas than it replenished.

Following Apollo 11, NASA Langley had moved beyond the waning aspirations of moonflight to manage the Viking missions to Mars—a planet some 65 million kilometers (40.39 million miles) away. Although not nearly as celebrated as the manned lunar landings, Project Viking rated as one of the greatest technological triumphs of all time, in some respects even surpassing Apollo. “To that day—maybe to this day—Viking was the most difficult unmanned space project ever taken,” a justifiably proud Edgar Cortright has declared. “It brought Langley to the forefront of spacecraft technology,” which was where Cortright thought Langley should be although many, like John Becker and Mike Ellis, would have preferred a return to the ways of the NACA and were calling for a “research renaissance.”²⁵ In Cortright’s mind and that of other avid participants in the spaceflight revolution, the Viking robots set the stage for a manned mission to the mysterious red planet, an adventure that they felt was sure to come before the end of the twentieth century. What Viking accomplished at Langley, however, was not altogether positive. Although it did keep the center focused on the technologies necessary for another successful space mission, the attention given to Viking continued a dangerous trend dating from the Apollo period; this trend marginalized research in favor of managing big projects, and thus was something that could not continue forever if the center was to live up to its original charter and serve the nation well over the long haul.

After Viking, Langley gave all-out support for the Space Shuttle. Langley’s contribution was a herculean engineering effort that was absolutely

necessary for the Shuttle's success but that prevented Langley researchers from seeking breakthroughs across the broadest possible technological front. Because NASA was staking so much of its future on just this one vehicle, every NASA facility was expected to provide support for the new STS, and Langley, relying on in-house capabilities developed largely during its NACA years, was still well equipped to help. The problems facing a hybrid reusable vehicle that was to fly into, through, and back from space, from blastoff to a landing on a runway, were unusually extreme. During any mission, the Shuttle had to pass through three distinctly different flight regimes: hypersonic, supersonic, and subsonic. Over the years, dating to the NACA period, Langley engineers had pioneered research in each one of these speed regimes and knew that each regime by itself posed difficult flight problems. Together, these problems made the Shuttle program into one of the biggest challenges Langley's wind-tunnel complex ever faced. Just to confirm the basic aerodynamic soundness and structural integrity of the Shuttle required more than 60,000 "occupancy hours" of testing in several tunnels over a period of an entire decade. Thousands of hours were necessary to optimize the design of the Shuttle's thermal protection system—a unique arrangement of ceramic tiles protecting the reusable vehicle from the intense heat of reentry. A team of over 300 Langley engineers and technicians put together by Director Donald P. Heath took on this sticky problem and eventually came up with a practical way of certifying the performance of the hundreds of glue-on tiles.²⁶

Although the Shuttle program predominated, many studies were conducted at Langley that explored the feasibility of advanced spaceflight technologies for future U.S. civil and military operations—many of them, but not all, were for manned missions. These investigations focused on new concepts like the "aerobrake," which was a technology with important applications for space transfer vehicles taking payloads and crews from a space station to the moon, to Mars, or even to other destinations in the inner Solar System.²⁷ Langley researchers also rehabilitated a few neglected older concepts such as the "lifting body," a promising technology that had been left in the lurch after Sputnik because powerful enough rockets did not yet exist to boost such a heavy vehicle to orbit. In the 1970s and 1980s, engineers at Langley helped to revitalize the lifting-body concept, and they eventually identified a highly innovative configuration called the HL-20 that offered a less expensive alternative to the Shuttle for direct manned access to orbit.²⁸ With NASA's new emphasis on "smaller, faster, cheaper, better" in the mid-1990s, Langley's persistent interest in the lifting body may yet pay off; perhaps it will be a convenient way of traveling to and from the international Space Station *Alpha*.

Something that will surely pay off in the future is Langley's sustained level of basic R&D in hypersonics, a field that has been one of the center's strengths since the early 1950s when NACA researchers pioneered concepts that were incorporated in the North American X-15. So solid was Langley's

Spaceflight Revolution

reputation in hypersonics that when the NASP program began under joint NASA/DOD sponsorship early in President Reagan's second term, Langley became the project's "lead center." By the early 1990s, although many critical engineering problems had yet to be solved before such a radically new technology (the prototype was labeled X-30) could become operational, Langley's involvements in NASP had proved the value of not only the revolutionary supersonic combustion ramjet engine (nicknamed "scramjet") but also of the novel integrated lifting-body aerothermal shape as the best suited for transatmospheric flight.²⁹

Like everything else that originated before the fall of the Berlin Wall, however, the NASP program was driven by cold war thinking. The DOD had planned to use the X-30 as a reconnaissance vehicle, a weapon against enemy satellites, and possibly as a nuclear bomber. Thus, with the collapse of the Soviet Union, the NASP program (as well as the SDI with which it was in certain ways associated) had to change fundamentally. Faced with a much smaller budget, NASP officials developed a plan in 1994 to close out work on the X-30 and transform the project from the development of a prototype military vehicle to the development of more generic hypersonic flight technologies.³⁰ Such a change, although it meant less money, signified a reorientation of R&D priorities more suited to an open intellectual environment wherein creative thinking about a wide range of technological possibilities can be better cultivated than in the so-called "black" world of top-secret military hardware development.

Another important effort that Langley managed to continue in the troubled post-Apollo era was its work on the cutting edge of wind-tunnel technology; this research was essential to the center's ability to stay vitally relevant in the twenty-first century. From the time of the Wright brothers, the wind tunnel had proved to be the essential piece of versatile experimental machinery on which much about the progressive evolution of aircraft depended. Without a new state-of-the-art tunnel, especially one that simulated the vexatious conditions of flight at transonic speeds (a regime that both high-speed aircraft and rockets had to fly through), Langley might have ceased being Langley, which had been for decades a mecca for aerodynamicists from around the world.

In the mid-1970s, NASA assured Langley's future by pursuing funding for what became the National Transonic Facility (NTF). The NTF was a radically new wind tunnel. It was to operate cryogenically with liquid nitrogen replacing air as the test medium. Conceptually, the NTF had roots going back to Langley's own Variable-Density Tunnel (VDT) of the early 1920s, which was a revolutionary machine that provided a pressurized airflow for higher Reynolds numbers (the parameter representing the accuracy of test results using scale models in a wind tunnel). With the VDT, the NACA had obtained more realistic aerodynamic data than anyone had yet been able to obtain from any previous tunnel. Like the VDT, which put the struggling early NACA on the world map, the NTF also represented breakthrough

technology. By using a spray of liquid nitrogen to refrigerate the tunnel's airstream, thereby dramatically decreasing its viscosity, the all-important Reynolds numbers could be increased up to five times with no increase in model loads or required drive power.³¹

Authorized by Congress in 1975, the incredibly complex NTF design, which was meant to serve the transonic R&D needs of both NASA and the DOD, became the major preoccupation of Langley for the rest of the decade and beyond. It gave Langley Director Don Heath and his associates endless headaches before all the kinks were worked out in 1982. The total cost of the NTF was \$85 million, much more than NASA could have afforded for such a general research tool during the 1960s when such large amounts of money could not have been spent without directly tying the project to the lunar landing. But the result was formidable. The most ambitious and expensive wind tunnel ever built anywhere, the NTF was quickly put to use, not only testing models of the Space Shuttle (the STS had to pass through the transonic speed range both to and from space) but also evaluating advanced subsonic transports, fighter aircraft, and attack submarines. Beginning in the late 1980s, NASP designs also underwent hundreds of hours in "The Big Cold One," as it came to be known.³²

The NTF incorporated the most modern automated equipment, which included four separate high-speed digital computers capable of handling up to 50,000 data points per second. These computers controlled virtually everything about the NTF, from monitoring the facility's environment to maneuvering the scale models in the test sections. When the NTF first began running in 1982, its builders felt that it would give the United States a full five-year technological lead over other countries and would "provide aspiring young aerodynamicists the wherewithal to design the aerospacecraft of the future."³³ Occasional tunnel mishaps and breakdowns led a few critical observers to question whether the NTF lived up to its billing, but as the fits and starts of Langley's earlier wind-tunnel history demonstrate, it sometimes takes years of refinement before such a basic research facility hits its full stride.

In important respects, the NTF helped to pave the way to Langley's future by recalling its strong NACA roots. Like the closed-loop circuitry of its NTF, NASA Langley by the mid-1990s seemed to be on the verge of coming full circle, not returning to the exact place where it had been 40 years earlier—history never really repeats itself—but arriving at a familiar spot closer to the one it occupied during the NACA, before Sputnik changed history. In 1993, NASA Langley officials estimated that 60 percent of its employees worked on aeronautics and only 40 percent on space. By the following year, the margin had widened to 70/30.³⁴

At Langley, this ratio points to a rather curious trend. Thirty-five years earlier, it was the aeronautical enthusiasts who were losing ground and becoming disgruntled with the transition to space at Langley. In the mid-1990s, it is the space enthusiasts who worry about the possibility that

Spaceflight Revolution

the rug might be pulled from under them. Aeronautics is coming back strong at Langley; space work is being taken away and assigned to other centers. The center has never forgotten that the first “A” in NASA stands for “Aeronautics.” Indeed, although its many achievements in aeronautics after Sputnik were usually overshadowed (as they are in this book) by the hype over spaceflight, the center still managed somehow to maintain its position as a world leader in aeronautical R&D. Langley’s contributions included the X-15, VTOL aircraft, the variable-sweep wing, the supercritical airfoil, SST-related technology, sonic boom studies, winglets, runway riblets, composite materials, laminar-flow control systems, and flight avionics. Still, NASA for its entire history had been the “space agency,” and aeronautics, although important, had played second fiddle.

True to the symbols in the original NASA logo (the “meatball”), which signify that the organization was about both aeronautics and space, Langley will continue to play a viable role in space.* Although Langley probably will not be conducting any space missions, it still stays active, in less visible but nonetheless critical ways, in space-related research. For example, researchers at the center continue to help design the space station and the next-generation space shuttle, repair and test space-bound instruments and materials, and conduct research on the effects of clouds and pollution on the earth’s atmosphere. As organized in early 1994, there will be four space “thrusts” at Langley: first, the Spacecraft Technology Thrust, which will entail the continued analysis of the space station design and a joint effort with NASA Goddard researchers to launch a spacecraft called the EOS-AM1, an unmanned earth-observing space vehicle, scheduled for launch in 1998; second, the Remote Sensing Thrust, which will involve development of instruments such as the Lidar In-Space Technology Experiment (LITE), which uses a laser system to probe the atmosphere and provide new information about the biosphere; third, the Space Transportation Technology Thrust, which will encompass the design of the next-generation space shuttle and the testing of spacecraft materials and structures to see how they hold up to extreme heat, sound, air pressure, and collisions with micrometeorites; and fourth, the Atmospheric Sciences Thrust (a research division created by Ed Cortright in the early 1970s), which will focus on NASA’s “Mission to Planet Earth” that was started in the 1980s and involves monitoring the

* Shortly after becoming NASA administrator, Daniel Goldin replaced the NASA “worm,” which had become the logo of the space agency in the 1970s, with the aesthetic blue “meatball” of NASA’s early days. Goldin decided to do this after visiting NASA Langley, seeing the handsome old NASA logo on the outside of the West Area flight hangar, and hearing from Langley’s center director, Paul Holloway, that a return to the old symbol would help improve NASA morale. Goldin agreed, thinking that it might be a good way of signaling NASA’s return as a high-quality, less bureaucratic organization. The decision, however, gave NASA’s graphics department and public affairs offices a fit, because it meant that all NASA letterhead and promotional materials had to be redone.

ozone hole and measuring the carbon monoxide and aerosol gases in the atmosphere.³⁵

Despite the general reorientation in favor of aeronautics, space will not be forgotten completely at Langley. As a local NASA beat reporter has written, "When man first set foot on the moon 25 years ago, NASA Langley Research Center was a star player in the space program, training astronauts and developing the lunar lander. But in the future, the Hampton research center will play a behind-the-scenes role in space research, like the football lineman who blocks for the star running back."³⁶ This general trend is as it should be—and as it was at Langley before Sputnik. Revolutions come and go, but basic research needs to stay.

Langley Research Center survived the spaceflight revolution and its aftermath. It helped the country accomplish some wonderful things along the way. With the changes in orientation that are now taking place inside NASA, the center is likely to remain productive well into the twenty-first century, if not beyond. To do so, however, Langley does not need to turn back the clock to before 1957 or necessarily return to the ways of the NACA, but it does need to refocus on what it does best. During the NACA years, it had a clarity of purpose that served it extremely well. Like the rest of NASA, it needs to regain much of its lost in-house capabilities and not depend so heavily upon contractors. If the staff has to become a little smaller and the overall organization a little leaner, that can work out to be a great advantage. The small size and more intimate collegiality of the NACA staff before World War II stimulated a high level of creativity within the organization. And above all, the bureaucracy in Washington must be streamlined and able to give a wide berth to people who want to follow through with bright ideas. Langley during the NACA years operated with maximum independence from NACA headquarters; somehow the best elements of that kind of freedom need to be revived in NASA.

Someday, the country may see another extraordinarily tempestuous time like the 12 years following Sputnik. Hopefully, if that time does come, Langley will again be in a general state of good health as it was when Sputnik first orbited the earth and will be able to make the tremendous contributions it made during the first spaceflight revolution. The ways and means of the old NACA are now mostly dead and gone, and Apollo anniversaries are a time to celebrate what now seems an impossible achievement. If Langley's future—and NASA's future—is to be as productive as the NACA and early NASA past, the spark of greatness in the present will have to come from something else besides the momentum of a satellite launched nearly 40 years ago by a country that no longer exists; it will have to come from a fresh new stream of historical development, only now at its headwaters.

Contrary to what many space enthusiasts inside and outside of NASA might still prefer to believe, the spaceflight revolution of the 1960s was something of an aberration. We should not look to Apollo as a model to emulate. That is what the children of the twenty-first century, who will not

Spaceflight Revolution

remember when there even was a Soviet Union or a Khrushchev toy called Sputnik, perhaps need most to understand about this history. The nervous energies that took us on our wonderful trips to the moon produced little in terms of a creative infrastructure that the country could hope to sustain for long; rather, they created a more expansive and plodding bureaucracy that has sustained itself quite well for the past three decades but only at great cost to what was worth saving in the first place.

Hopefully, Langley Research Center and the rest of NASA will continue to find ways through the dawn of the next millennium to recover the best about what they have been, and still should be, no matter what convulsion—or realized impossible dream—any future revolution might bring.

Abbreviations

AAS	American Astronomical Society
ABL	Allegheny Ballistics Laboratory
ABMA	Army Ballistic Missile Agency
AC	alternating current
ACD	Analysis and Computation Division
ACLOPS	Agema-Class Lunar Orbiter Project
AFB	air force base
AGARD	Advisory Group for Aeronautical Research and Development
AIAA	American Institute for Aeronautics and Astronautics
AMIS	Advanced Man in Space
AORL	Apollo Orbital Research Laboratory
ARPA	Advanced Research Projects Agency
AT&T	American Telephone and Telegraph
ATOPS	Advanced Transport Operating System
AVRO	A.V. Roe Aircraft Corporation
BellComm	Bell Communications
CAN	Nike-Cajun
CIA	Central Intelligence Agency
CM	command module
CNN	Cable News Network
comsat	communication satellite
ComSatCorp	Communications Satellite Corporation
DAN	Nike-Deacon
DC	direct current
DOD	Department of Defense

Spaceflight Revolution

EDT	eastern daylight time
EOR	earth-orbit rendezvous
ESRO	European Space Research Organization
F	Fahrenheit
FAA	Federal Aviation Administration
FRC	Flight Research Center
FY	fiscal year
G.E.	General Electric
Heos	Highly Eccentric Orbiting Satellite
HRE	hypersonic research engine
IAF	International Astronautical Federation
IAS	Institute of Aeronautical Sciences
IAU	International Astronomical Union
ICASE	Institute for Computer Applications in Science and Engineering
ICBM	intercontinental ballistic missile
IEEE	Institute of Electrical and Electronic Engineers
IGY	International Geophysical Year
ILSS	Integrative Life Support System
Intelsat	International Telecommunications Satellite Consortium
IPAD	Integrated Program for Aerospace-Vehicle Design
IRD	Instrument Research Division
JPL	Jet Propulsion Laboratory
K	kelvin
LCF	Langley Central Files
LEM	lunar excursion module
LHA	Langley Historical Archives
LITE	Lidar In-Space Technology
LOLA	Lunar Orbit and Letdown Approach Simulator
LOPO	Lunar Orbiter Project Office

Abbreviations

LOR	lunar-orbit rendezvous
LORL	Large Orbiting Research Laboratory
LRC	Langley Research Center
LTV	Ling-Temco-Vought
MALLAR	Manned Lunar Landing and Return
MALLIR	Manned Lunar Landing Involving Rendezvous
MHD	magnetohydrodynamics
MISS	Man-In-Space-Soonest Project
MIT	Massachusetts Institute of Technology
MOL	Manned Orbiting Laboratory
MORAD	Manned Orbital Rendezvous and Docking
MORL	Manned Orbiting Research Laboratory
MPD	magnetoplasmadynamics
MSC	Manned Spacecraft Center
MSFC	Marshall Space Flight Center
MTSS	Military Test Space Station
MWDP	Mutual Weapons Defense Program
NACA	National Advisory Committee for Aeronautics
NASA	National Aeronautics and Space Administration
NASA HQ	NASA headquarters
NASA HQA	NASA Headquarters Archives
NASA NP	NASA Publication
NASA RP	NASA Reference Publication
NASA SP	NASA Special Publication
NASA TN	NASA Technical Note
NASA TR	NASA Technical Report
NASP	National Aero-Space Plane
NASTRAN	NASA Structural Analysis
NATO	North Atlantic Treaty Organization
NHFRF	National Hypersonic Flight Research Facility
NOSS	National Orbiting Space Station

Spaceflight Revolution

NRL	Naval Research Laboratory
NTF	National Transonic Facility
OART	Office of Advanced Research and Technology
OHC	Oral History Collection
OSSA	Office of Space Sciences Applications
Pageos	Passive Geodetic Earth-Orbiting Satellite
Parasev	Paraglider Research Vehicle
PARD	Pilotless Aircraft Research Division
PC	personal computer
PCC	Peninsula Chamber of Commerce
PSAC	President's Science Advisory Committee
R&D	research and development
RA	Research Authorization
RAM	Radio Attenuation Measurements
RAP	Research Airplane Project
RCA	Radio Corporation of America
rpm	revolutions per minute
RRA	Resident Research Associate
Saint	Satellite Interceptor project
SCAT	Supersonic Commercial Air Transport
SDI	Space Defense Initiative
SEPC	Space Exploration Program Council
SETI	Search for Extraterrestrial Intelligence
SM	service module
SMD	Space Mechanics Division
SNAP	Systems for Nuclear Auxiliary Power
SST	supersonic transport
STG	Space Task Group
STL	Space Technologies Laboratories
STS	Space Transportation System
TAGIU	Tracking and Ground Instrumentation Unit

Abbreviations

TCVA	Terminal Configured Vehicle and Avionics
Texas A&M	Texas Agricultural and Mechanical University
TRW	Thompson-Ramo-Wooldridge
TWGEP	Technical Working Group for Electric Propulsion
UHF	ultra-high frequency
USNC/IGY	U.S. National Committee/International Geophysical Year
VDT	Variable-Density Tunnel
V/STOL	vertical and short takeoff and landing
VHF	very high frequency
WS-110A	Weapons System-110A

Notes

A Caveat to Chapter Notes

Many of the following notes refer to a piece of correspondence by file number (e.g., A32-1, LCF [Langley Central Files]). The NACA/early NASA correspondence files have been accessioned by the National Archives (NASA Record Group). Any reference that appears as above is now in the National Archives. This caveat applies only to correspondence by file number in the Langley Central Files. Other references to documents in the Langley Central Files and Langley Historical Archives are correct as of publishing date.

Prologue

1. George Will, "What Paths Would the Nation Have Taken Had Taylor Lived?" *Washington Post*, 20 June 1991.
2. Ward Moore, *Bring the Jubilee* (London: Heinemann, 1955).
3. Will, "What Paths."
4. John Noble Wilford, "A Spacefaring People: Keynote Address," in *A Spacefaring People: Perspectives on Early Spaceflight*, ed. Alex Roland, NASA SP-4405 (Washington, 1985), p. 69.
5. See Walter A. McDougall, *The Heavens and the Earth: A Political History of the Space Age* (New York: Basic Books, 1985), p. 123; also Frederick I. Ordway III and Mitchell R. Sharpe, *The Rocket Team* (New York: Crowell, 1979), pp. 377-378.
6. See chap. 5, "The Satellite Decision," pp. 112-134, in McDougall, *Heavens and the Earth*.
7. McDougall, *Heavens and the Earth*, pp. 153-154; on Project Vanguard, see Constance M. Green and Milton Lomask, *Vanguard: A History*, NASA SP-4202 (Washington, 1970).
8. Wilford, "A Spacefaring People," pp. 69-70. For a persuasive account of the responses of American policymakers to the launching of *Sputniks 1* and *2*, see Robert A. Divine, *The "Sputnik" Challenge: Eisenhower's Response to the Soviet Satellite* (New York: Oxford University Press, 1993); for an interesting revisionist interpretation, see Rip Bulkeley, *The Sputniks Crisis and Early United States Space Policy* (Bloomington, Ind.: Indiana University Press, 1991). Bulkeley argues that no U.S. president could have quieted the alarm aroused in 1957-1958 by the Soviet demonstration of ICBM capability. If the Soviet Union had been only the *second* country in the world to orbit a satellite, the American electorate would have still perceived the ICBM demonstration as a cataclysmic threat to its strategic security and as a turn of events demanding an instant and dramatic response from the country's leadership. Although Dr. Bulkeley's thesis has some merit, I remain convinced that the post-Sputnik media riot and the country's generally hysterical

Notes for Prologue

reaction could have been generated only in response to the Soviets having the *first* space launch. If the Soviets had been *second* into space, I do not believe that the NACA would have been abolished and NASA established before a year had passed.

9. For an analysis of this close election, see pp. 350–365 of Theodore H. White, *The Making of the President, 1960* (New York: Atheneum, 1961).
10. For a critical interpretation of the history of the NACA, NASA's predecessor, see Alex Roland, *Model Research: The National Advisory Committee for Aeronautics, 1915–1958*, 2 vols., NASA SP-4103 (Washington, 1985). For more sympathetic interpretations focusing on the operations of the NACA's various research laboratories, see Richard P. Hallion, *On the Frontier: Flight Research at Dryden, 1946–1981*, NASA SP-4303 (Washington, 1984); Elizabeth A. Muenger, *Searching the Horizon: A History of Ames Research Center, 1940–1976*, NASA SP-4304 (Washington, 1985); James R. Hansen, *Engineer in Charge: A History of the Langley Aeronautical Laboratory, 1917–1958*, NASA SP-4305 (Washington, 1987); and Virginia P. Dawson, *Engines and Innovation: Lewis Laboratory and American Propulsion Technology*, NASA SP-4306 (Washington, 1991). For a brief survey treatment, see Roger E. Bilstein, *Orders of Magnitude: A History of the NACA and NASA, 1915–1990*, NASA SP-4406 (Washington, 1989).
11. James R. Hansen, "Transition to Space: A History of Space Plane Concepts at Langley Aeronautical Laboratory, 1952–1957," *Journal of the British Interplanetary Society* 40 (Feb. 1987): 67–80. For additional historical and engineering analysis of the technologies pertinent to the development of hypersonic boost-gliders and other "space planes," see *The Hypersonic Revolution: Eight Case Studies in the History of Hypersonic Technology*, ed. Richard P. Hallion (Wright-Patterson AFB, Ohio: Special Staff Office, Aeronautical Systems Division, 1987).
12. On the many twists and turns of NASA's space station development since the late 1950s, see Howard E. McCurdy, *The Space Station Decision: Incremental Politics and Technological Choice* (Baltimore and London: Johns Hopkins University Press, 1990).
13. Eric Hoffer, *Before the Sabbath* (New York: Harper and Row, 1979), p. 55.
14. On NASA's controversial decision to go to the moon via lunar-orbit rendezvous, see John Logsdon, "Selecting the Way to the Moon: The Choice of the Lunar-Orbit Rendezvous Mode," *Aerospace Historian* 18 (June 1971): 66–70. On the demise of the American SST program, see Mel Horwitch, *Clipped Wings: The American SST Conflict* (Cambridge, Mass., and London: MIT Press, 1982). On the space station, see McCurdy, *The Space Station Decision*, pp. 30–31. The books we have on the Space Shuttle *Challenger* accident came out in the immediate aftermath of the tragedy and really do not adequately explore either the causes of the explosion or the character of the follow-up investigation by the presidential commission chaired by former Secretary of State William Rogers. Essentially, they are little more than examples of sensational journalism. For the best treatment of the forces at work in the Space Shuttle *Challenger* disaster, see Michael Collins, *Liftoff: The Story of America's Adventure in Space* (New York: NASA/Grove Press, 1988), pp. 222–242. As a former NASA astronaut (Gemini X and Apollo XI), Collins is, of course, sympathetic to NASA's interests; however, he provides a keen analysis of what went wrong with the Space Shuttle program.

15. Lewis Carroll, *Alice's Adventures in Wonderland and Through the Looking-Glass* (New York: Macmillan Co., 1963), bk. 2, p. 43.
16. Thomas S. Kuhn, *The Structure of Scientific Revolutions* (University of Chicago Press, 1962).
17. *Ibid.*, p. 91.
18. For an extensive and interesting application of Kuhn's theory of revolution, see Edward Constant II, *Origins of the Turbojet Revolution* (Baltimore: Johns Hopkins University Press, 1980).
19. William Sims Bainbridge, *The Spaceflight Revolution: A Sociological Analysis* (New York: John Wiley & Sons, 1976), p. 1.
20. On the Committee for the Future, see Bainbridge, *The Spaceflight Revolution*, pp. 12–14 and 158–197. On the deviancy of science-fiction fandom, see pp. 227–233.
21. *Ibid.*, p. 4.

Chapter 1

The Metamorphosis

1. In the wake of Sputnik, Eisenhower created a President's Science Advisory Committee (PSAC) from an existing science advisory board that was helping the Office of Defense Mobilization; chairing the new PSAC was James R. Killian, Jr., president of MIT and new special assistant to the president for science and technology. Eisenhower asked the committee to identify American objectives in space and advise him on how those objectives could best be met. On 22 Feb. 1958, the PSAC recommended in a preliminary staff document entitled "Organization for Civil Space Programs" (copy in NASA HQA) that a new space agency be established with the NACA as its nucleus. NACA leaders learned about this recommendation and passed informal word of it to their laboratories soon thereafter. On 2 Apr. 1958, all NACA Main Committee members received a confidential letter from the NACA's executive secretary informing them that the president, following the PSAC recommendation, had just sent a plan for a new space agency to Congress.

See John F. Victory's letter to Floyd L. Thompson, Langley associate director, with attached memorandum from Dwight D. Eisenhower to the secretary of defense and the chairman of the NACA, 2 Apr. 1958, plus the attached White House press release, marked "strictly confidential" and dated 2 Apr. 1958, 12:00 noon EST, with the text of Eisenhower's message to Congress. The letter from Victory to Thompson is in the folder "Space Material," Floyd L. Thompson Collection, LHA.

For a historical analysis of Killian's and the PSAC's role in the establishment of NASA, see Walter A. McDougall's Pulitzer Prize-winning book, *The Heavens and the Earth: A Political History of the Space Age* (New York: Basic Books, 1985), pp. 170–172.

2. For Eisenhower's reaction to Sputnik and his concerns about the militarization of space, see McDougall, *Heavens and the Earth*, pp. 158–176. The reader needs to pay special attention, however, to McDougall's interpretation of the NACA in these pages. On page 164, for instance, McDougall argues that "by the mid-1950s the venerable NACA was slumping. It was the best equipped aeronautical research organization in the world, but institutional conservatism and financial strictures rendered its future very dubious." In

Notes for Chapter 1

the opinion of other historians, including myself, McDougall's portrayal of the NACA in its last years is off the mark. The NACA was not in any slump. In the years just preceding 1958, the NACA was involved in some of the most productive work it had ever done. McDougall's interpretation implies that the NACA died of old age. An alternative interpretation, which I support, would suggest that the NACA was killed in its prime. It was not Sputnik per se that killed it; it was the hysterical American reaction to the threat posed by the Soviet satellite. For criticism of McDougall's interpretation of the late NACA similar to my own, see Richard P. Hallion's review of *Heavens and the Earth* in *Technology and Culture* 28 (Jan. 1987): 130–132, and Virginia P. Dawson, *Engines and Innovation: Lewis Laboratory and American Propulsion Technology*, NASA SP-4306 (Washington, 1991), p. 162.

3. Alex Roland, *Model Research: The National Advisory Committee for Aeronautics, 1915–1958*, 2 vols., NASA SP-4103 (Washington, 1985), 1:1–25. On the NACA's inaugural meeting, see the “Minutes of Meeting of National Advisory Committee for Aeronautics held in the War Department of Washington, D.C., April 23, 1915,” cited in Roland, *Model Research*, 1:27 and 326 n. 2.
4. Charles J. Donlan interview with author, Hampton, Va., 17 Aug. 1990, transcript, pp. 34–35, OHC, LHA.
5. For the full text of the NACA charter, see app. A to James R. Hansen, *Engineer in Charge: A History of the Langley Aeronautical Laboratory, 1917–1958*, NASA SP-4305 (Washington, 1987), p. 399.
6. Tom D. Crouch offers an excellent and fair appraisal of Samuel P. Langley's mixed contributions to aeronautics in *A Dream of Wings: Americans and the Airplane, 1875–1905* (New York and London: W. W. Norton & Co., 1981). See especially chap. 7, “S. P. Langley: The Scientist as Engineer,” pp. 127–156, and chap. 12, “The Great Aerodrome,” pp. 255–283. A 1988 paperback version of Crouch's book is available from the Smithsonian Institution Press.
7. On the NACA's annual Aircraft Manufacturers' Conferences (later called NACA inspections), see Roland, 1:111–114 and 232–233, and my own *Engineer in Charge*, pp. 148–158.
8. This opinion was expressed by British aviation journalist C. G. Grey in an obituary for NACA Director of Research George W. Lewis, published in *The Aeroplane*, 27 Aug. 1948. More recently, distinguished American aviation historian Richard K. Smith wrote in the Smithsonian Institution's *Milestones of Aviation* (New York: Hugh Lauter Levin, 1989) that “in the years 1928–1938 no other institution in the world contributed more to the definition of the modern airplane than the Langley Laboratory of the U.S. National Advisory Committee for Aeronautics” (p. 240).

For the history of Ames laboratory, see Edwin P. Hartmann, *Adventures in Research: A History of Ames Research Center, 1940–1965*, NASA SP-4302 (Washington, 1970), and Elizabeth A. Muenger, *Searching the Horizon: A History of Ames Research Center, 1940–1985*, NASA SP-4304 (Washington, 1985); and for a history of Lewis, see Virginia P. Dawson, *Engines and Innovation*. On the High-Speed Flight Station at Muroc Dry Lake (later renamed Dryden Flight Research Center), see Richard P. Hallion, *On the Frontier: Flight Research at Dryden, 1946–1981*, NASA SP-4303 (Washington, 1984). The best work so far on the history of Wallops Island is Joseph A. Shortal, *A New Dimension: Wallops Flight Test Range, The First Fifteen Years*, NASA RP-1028 (Washington, 1978).

Notes for Chapter 1

9. Jerome C. Hunsaker interview with Walter Bonney, 2 Nov. 1971, transcript, p. 1, OHC, LHA.
10. For all the details, plus a critical analysis, of the NACA committee system, consult Roland, *Model Research*, esp. app. B, 2:423–465. For a rough breakdown of the roles played by the various committees, see Hansen, *Engineer in Charge*, pp. 5–9.
11. A biography of Hugh Dryden is badly needed. The place to start is Richard K. Smith, *The Hugh L. Dryden Papers, 1898–1965: A Preliminary Catalogue of the Basic Collection* (Baltimore: Milton S. Eisenhower Library, Johns Hopkins University Press, 1974). Dr. Smith, who compiled and edited this collection of Dryden's papers, informs me that the collection is in truth a rather meager potpourri.

Our picture of George W. Lewis is a little more complete. See, for example, my chapter, "George W. Lewis and the Management of Aeronautical Research," in William P. Leary's biographical anthology, *Aviation's Golden Age: Portraits from the 1920s and 1930s* (Iowa City: University of Iowa Press, 1989), pp. 93–112. Those interested in source materials about George Lewis should consult my short bibliographical essay about him at the end of Leary's book (pp. 186–187).

12. Some of the "young Turks" came from Langley (for example, Robert Gilruth and Max Faget, future leaders of the NASA Space Task Group, which put together Project Mercury), but the leading group developed at NACA Lewis. This group was led by Lewis's dynamic associate director, Abe Silverstein, and included, among others, such promising young men as George Low, who before too many years would be heading NASA's Manned Lunar Landing Task Force, and Edgar M. Cortright, Jr., future director of NASA Langley (1968–1976). To be a "young Turk" in 1957–1958 meant to be an NACA employee who, in historian Alex Roland's words, "wanted the NACA to campaign for a broad new role in space" (*Model Research*, 1:292). The title apparently dated from an informal NACA dinner meeting hosted by NACA Chairman Jimmy Doolittle in Washington on 18 Dec. 1957. During the dinner, an NACA generation gap became obvious over the issue of what the NACA's role should be in space, and Langley's intemperate John Stack called Hugh Dryden "an old fogey." To qualify the inferences drawn from Roland's portrayal, I must add that Stack's passion rested squarely in aeronautics; he was hardly a "space cadet" as Roland (and McDougall) seems to suggest. A few months after the Washington dinner, in the spring of 1958, Silverstein reported to Washington, at Dr. Dryden's request, to take on the huge job of inventing NASA's spaceflight development program. He eventually brought with him to Washington several other Lewis people. On this subject, see also Dawson, *Engines and Innovation*, pp. 163–166. In *Heavens and the Earth*, McDougall refers to the "young Turks" as the NACA's "frontier faction" (p. 200). However, the NACA actually employed two frontier factions: one devoted to space and one devoted to aeronautics. The spaceflight revolution, in key respects, left members of the second group behind.
13. "Biographical Sketch of Dr. T. K. Glennan," *Langley Air Scoop*, 15 Aug. 1958. On the front page of the same issue was a news item, "President Announces Nominees to Head NASA."
14. Both Roland and McDougall refer to the occasion when Hugh Dryden told the House Space Committee in the spring of 1958 that some of the ideas being proposed for putting Americans into space have "about the same technical value as the circus stunt of shooting

Notes for Chapter 1

- a young lady from a cannon.” Sensibly cautious remarks like this did not endear Dryden to congressmen who were in a rush to see Americans in space and made his selection as the first NASA administrator politically impossible. *Model Research*, 1:299; *Heavens and the Earth*, pp. 195–196.
15. A seven-page carbon transcript of “Glennan Message to NACA Employees,” dated 22 Sept. 1958, can be found in the folder marked “Space Material” in the Thompson Collection, LHA. Glennan did not make his first trip to Langley until Wednesday, 7 Jan. 1959. Accompanying the administrator was Hugh Dryden, deputy administrator, as well as a number of other NASA headquarters officials. The group arrived at Langley around 11:30 a.m., after a brief stop to see research facilities at Wallops Island, and they returned to Washington in the late afternoon. Glennan and his staff toured a number of Langley wind tunnels in which various tests were being conducted in support of NASA’s nascent space programs. See the article “Glennan Views Facilities, Hears Research Reports,” in *NASA Langley Air Scoop*, 9 Jan. 1959.
 16. “Glennan Message,” pp. 1–2.
 17. T. Keith Glennan, “The First Years of the National Aeronautics and Space Administration,” unpublished diary, 1964, Eisenhower Library, Abilene, Kans., 1:6–7. Subsequent to the drafting of this book, NASA published an edited version of Glennan’s diary, *The Birth of NASA: The Diary of T. Keith Glennan*, ed. J. D. Hunley, NASA SP-4105 (Washington, 1993).
 18. Donlan interview, 17 Aug. 1990, p. 9.
 19. “Glennan Message,” pp. 2–3.
 20. *Ibid.*, pp. 3–4.
 21. Quoted in “Glennan Message,” pp. 6–7.
 22. Floyd L. Thompson interview with Walter Bonney, Hampton, Va., 28 July 1975, transcript, p. 25, OHC, LHA; on the history of NACA Wind Tunnel No. 1, see Hansen, *Engineer in Charge*, pp. 69–72 and 442.
 23. For detailed inventories of the history of the NACA’s wind tunnels, see Roland, *Model Research*, 2:507–528, and Hansen, *Engineer in Charge*, pp. 441–478.
 24. *Flight Log Book, 1958*, 7 Oct. 1958, Langley Flight Log Book Collection, LHA; next to the F-101A entry are the words “Hubbard’s Sound Flight.” See also Domenic J. Maglieri, Harvey H. Hubbard, and Donald L. Lansing, “Ground Measurements of the Shock-Wave Noise From Airplanes in Level Flight at Mach Numbers to 1.4 and at Altitudes to 45,000 Feet,” NASA TN D-48, Sept. 1959. For information on the variable-electronic control system, see Siguard A. Sjoberg, “Flying Qualities Associated with Electronic Flight Control Systems,” NASA TN-66282, 5–6 Nov. 1958.
 25. Quoted in Charles Murray and Catherine Bly Cox, *Apollo: Race to the Moon* (New York: Touchstone Books, 1989), p. 31.
 26. Ira H. Abbott, “A Review and Commentary of a Thesis by Arthur L. Levine, Entitled ‘A Study of the Major Policy Decisions of the National Advisory Committee for Aeronautics,’ Dated 1963,” NASA HQA, HHN-35, Apr. 1964, p. 195. The LHA also preserves a copy of Abbott’s manuscript.
 27. H. J. E. Reid to Dr. Hugh L. Dryden, “Transmittal of Report on Review of Langley Research Effort,” 31 Jan. 1958, A200-1A, LCF. A photocopy of this report is also in the Thompson Collection, LHA, in the folder “Space Material.”

28. Langley was a strong supporter of the Dyna-Soar project. Inaugurated by the U.S. Air Force in Nov. 1957, the concept was for the design and operation of an experimental manned hypersonic glider, designated the X-20, that could fly out of the atmosphere, bounce in and out of shallow earth orbit for at least a large part of a trip around the planet, and return home to a runway landing. Even before the NACA's formal agreement in May 1958 to support the air force's manned military space project, Langley had been active in hypersonic and boost-glider research. Some of its researchers and facilities stayed active in support of Dyna-Soar until the DOD canceled the project in Dec. 1963. For firsthand insights into Langley's involvement in Project Dyna-Soar, see John V. Becker, "The Development of Winged Reentry Vehicles," unpublished manuscript, May 1983, pp. 35–51, copy in the LHA. For a brief critical examination of the Dyna-Soar's controversial history, see McDougall, *Heavens and the Earth*, pp. 339–341.
29. In midsummer 1958, Stack visited the Vickers organization in Weybridge, England, to review a British proposal for the Swallow arrow-wing aircraft. The proposal consisted of a plan for a 25,000-pound research airplane derived from the Swallow configuration that would be the progenitor of a supersonic commercial transport. Stack made several trips to Europe in the late 1950s and early 1960s as an NACA/NASA representative to NATO meetings concerning the Mutual Weapons Defense Program (MWDP). For information on the Swallow and Stack's trips to Europe, see the miscellaneous material in the folders marked "MWDP," in section 6 of the John Stack Collection, LHA.
30. James R. Hansen, "Transition to Space: A History of 'Space Plane' Concepts at Langley Aeronautical Laboratory 1952-1957," *Journal of the British Interplanetary Society* 40 (1987): 67–80. On the X-15, see Richard P. Hallion, *On the Frontier*, pp. 101–129, and Milton O. Thompson, *At the Edge of Space: The X-15 Flight Program* (Washington and London: Smithsonian Institution Press, 1992).
31. Thompson interview with Bonney, 28 July 1975, p. 20.
32. *Ibid.*
33. Murray and Cox, *Apollo*, p. 28.
34. Roland, *Model Research*, 1:135-137; Hansen, *Engineer in Charge*, pp. 145–146.
35. Caldwell Johnson quoted in Murray and Cox, *Apollo*, p. 28.
36. For an appraisal of Langley's research environment in the early years, see Hansen, *Engineer in Charge*, pp. 33–40. For an insightful autobiographical look into the freedoms of NACA laboratory research, read John V. Becker, *The High-Speed Frontier: Case Histories of Four NACA Programs, 1920–1950*, NASA SP-445 (Washington, 1980). Becker, who came to work at Langley in 1936, did pioneering research in high-speed aerodynamics culminating in major contributions to the X-15 program.
37. Murray and Cox, *Apollo*, p. 27.
38. In essence, the deal with the Selective Service System called for the induction of eligible Langley employees into the Army Air Corps Enlisted Reserves. However, NACA inductees received no military training, never wore a uniform, and spent absolutely no time on active duty. For the details of this arrangement, see Hansen, *Engineer in Charge*, pp. 203–205.

Chapter 2
The First NASA Inspection

1. As had been the case for the NACA's annual manufacturers' conferences, Langley's planning for NASA's First Anniversary Inspection was complete. The typically exhaustive thoroughness of preinspection planning is evident in both the abundance and the detail of the extant archival material. This material includes several relevant internal memoranda, including an "Operation and Policy" statement; all purchase requests; complete lists of the invited guests plus copies of the invitations; all programs and booklets; representative visitor identification badges; luncheon menus; maps of tour-bus routes; as well as group photos, sheets with daily attendance figures, selected press-coverage clippings, and all NASA press releases. In the LHA are five large folders of material for the 1959 inspection. They are located, along with the records for the 1964 NASA inspection (also held at Langley), in a special cabinet drawer labeled "1959 Inspection-1964 Inspection." Material on the 1959 inspection can also be found in E6-1E, LCF. Langley's correspondence files are located in the LHA.
2. "The Nice NASA Show for the People," Newport News (Va.) *Daily Press*, 27 Oct. 1959.
3. "Nearly 20,000 at Open House; Public Pays First Visit to NASA," Newport News *Daily Press*, 25 Oct. 1959.
4. "Nice NASA Show," *Daily Press*.
5. Axel T. Mattson, "Synopsis of the NASA First Anniversary Inspection, Technical Presentations," 6 July 1959, p. 1, in 1959 inspection folder labeled "NASA 'First Anniversary Inspection' LRC-1959 Policy Statement," in the "1959 Inspection-1964 Inspection" drawer.
6. T. Melvin Butler, Langley administrative management officer, "Memorandum for All Concerned; Subject: Special Duties for the 1959 NASA Inspection at Langley Research Center," 5 Oct. 1959, and "Information for Group Leaders and Assistant Group Leaders, NASA 1959 Inspection," 9 Oct. 1959. Both memoranda are in the "1959 Inspection File" in the LHA. For in-house news stories (with photographs) on the 1959 inspection, see the 16 Oct. 1959 issue of the *Langley Air Scoop*. For outside technical reviews, consult the 19 Oct., 26 Oct., and 2 Nov. 1959 issues of *Aviation Week*. An editorial team from *Aviation Week* covered all four days of the NASA inspection and published several articles on NASA's research highlights. Most of these articles, however, were based largely on NASA's press releases prior to the inspection.
7. See folder entitled "NASA 'First Anniversary Inspection' LRC-1959 Policy Statement" for correspondence between Langley and the various NASA centers regarding their participation in the 1959 inspection. See also the relevant NASA press releases in the "Press Releases" folder for the 1959 inspection. On the cancellation of the Vega program, see "NASA Kills Vega, Adopts USAF Agena," *Aviation Week*, 21 Dec. 1959, and "Vega Out, Hopes Pinned on Centaur," *Missiles and Rockets*, 21 Dec. 1959.
8. Axel Mattson interview with author, 14 Aug. 1989, Hampton, Va., transcript, pp. 9-10, OHC, LHA. At the time, Mattson was the assistant chief of Langley's Full-Scale Research Division.
9. Mattson interview, 14 Aug. 1989, pp. 9-10.
10. *Ibid.*

11. Ibid., pp. 2–5 and 11. See also Axel Mattson to the associate director. The Langley correspondence files, E6-1E, LCF, contain several letters from Mattson to Langley and NASA headquarters concerning his visits to JPL, Goddard, and other NASA centers in preparation for the 1959 inspection.
12. Mattson interview, 14 Aug. 1989, p. 5.
13. Charles J. Donlan interview with author, Hampton, Va., 17 Aug. 1990, transcript, p. 16, OHC, LHA.
14. Mattson interview, 14 Aug. 1989, p. 4.
15. Smith J. DeFrance to Dr. H. J. E. Reid, 29 Oct. 1959, E6-1E, LCF.
16. H. J. E. Reid to Dr. Smith J. DeFrance, 30 Oct. 1959, E6-1E, LCF.
17. Englishman John Hodge had joined the STG in the spring of 1959 along with 30 other engineers who had been handpicked by the STG after they had been laid off by the AVRO (A. V. Roe) aircraft corporation in Canada; a new Conservative government in Ottawa had canceled a project for the building of a technologically innovative supersonic interceptor, the CF-105 Arrow, and some swift action by NASA had allowed the space agency to acquire some exceedingly talented people. Hodge became the second NASA flight director—Christopher C. Kraft’s deputy—at Mission Control in Houston. It was his misfortune to be the flight director on duty during the tragic *Apollo 1* fire that killed astronauts Roger Chaffee, Edward White, and Virgil Grissom in Jan. 1967. Subsequent to the Apollo program, Hodge served as director of NASA’s Space Station Task Force. Windler also became a Houston flight director, and Huss, too, served in Mission Control. On the recruitment of the Canadians into NASA’s space program, see Loyd S. Swenson, Jr., James M. Grimwood, and Charles C. Alexander, *This New Ocean: A History of Project Mercury*, NASA SP-4201 (Washington, 1966), p. 153, as well as Charles Murray and Catherine Bly Cox, *Apollo: The Race to the Moon* (New York: Touchstone Books, 1989), pp. 21–23. See also Donlan interview, 17 Aug. 1990, p. 21.
18. Among the Langley documents relevant to the establishment of the STG, see especially Paul E. Purser to Robert R. Gilruth, “Initial Hiring of Personnel for Space Center,” 3 Sept. 1958; and Robert R. Gilruth to Langley Associate Director Floyd L. Thompson, “Space Task Group,” 3 Nov. 1958. Both letters can be found in the Floyd L. Thompson Collection, LHA. On the formation of the STG, see also Gilruth’s “Memoir: From Wallops Island to Mercury, 1945–1958,” unpublished manuscript presented at the Sixth International History Symposium, Vienna, Austria, 13 Oct. 1972, pp. 39–42, copy in LHA. For an excellent history of NASA’s Project Mercury, see Swenson, Grimwood, and Alexander, *This New Ocean*.
19. STG script for “NASA 1959 Inspection: Project Mercury,” Oct. 1959, p. 1. All of the scripts for presentations given at the 1959 inspection are in the folder labeled “Press Releases, 1959 Inspection,” in the 1959–1964 inspection drawer in the LHA.
20. Donlan interview, 17 Aug. 1990, pp. 29–30.
21. Swenson, Grimwood, and Alexander, *This New Ocean*, pp. 237–238. See also John A. (Shorty) Powers’ memorandum for STG files, “Response to queries about Astronauts’ personal stories,” 27 Aug. 1959, C136-1, LCF.
22. STG script, “Project Mercury,” pp. 1–2.

Notes for Chapter 2

23. Gilruth, "Memoir," p. 45. On NASA's selection of the Mercury astronauts, see Swenson, Grimwood, and Alexander, *This New Ocean*, pp. 129–131; also Mae Mills Link, *Space Medicine in Project Mercury*, NASA SP-4003 (Washington, 1965), pp. 44–46.
24. By this time Bob Champine, one of Langley's most talented test pilots, had already experienced the high G-forces of the navy's centrifuge at Johnsville, Pa., and had also ridden several of the Project Mercury simulators, so he knew what NASA astronauts must endure. See Swenson, Grimwood, and Alexander, *This New Ocean*, pp. 43 and 94. For some thoughts on the tortures of the wheel from the perspective of a Gemini and Apollo astronaut, see Michael Collins, *Liftoff: The Story of America's Adventure in Space* (New York: NASA/Grove Press, 1988), pp. 30–31.
25. Yeager quoted in Collins, *Liftoff*, p. 46.
26. In the LHA, I have left a folder with photocopies of dozens of local newspaper stories about the Mercury astronauts. The chief local reporter covering the astronauts was Virginia Biggins, columnist for the Newport News *Times Herald*. In her column, "Point of View," Ms. Biggins often covered the personal lives of the astronauts, in spite of the notoriously restrictive Time-Life contract. For some fascinating recollections of the Project Mercury astronauts and their days in the Hampton Roads area, see the transcript of my interview with Ms. Biggins, dated 1 Aug. 1990, OHC, LHA; for comments on how she was able to work around the Time-Life restrictions, see pp. 4–5. A Langley videotape of a presentation made by Ms. Biggins in July 1991 at the former Langley Visitors' Center on her recollections of the days when the astronauts were training at Langley is available through the Langley Office of Public Services.
27. See Robert Voas, "Project Mercury Astronaut Training Program," unpublished paper presented at the Symposium on Psychophysiological Aspects of Space Flight, San Antonio, Tex., 26–27 May 1960, copy in Langley Technical Library. Dr. Voas (a navy lieutenant with a Ph.D. in psychology) served on the NASA astronaut selection committee and became a formal member of the organization within the STG that evaluated, tested, and trained the Mercury astronauts. For a virtually complete bibliography of Voas's contemporary papers and presentations on Mercury astronaut training, consult the NACA/NASA card file in the Langley Technical Library. For a historical analysis of Mercury astronaut selection and evaluation, as well as the role of Dr. Voas and others in it, see Swenson, Grimwood, and Alexander, *This New Ocean*, pp. 159–165.
28. Swenson, Grimwood, and Alexander, *This New Ocean*, pp. 237–238.
29. See STG script, "Project Mercury," pp. 3–5. John Glenn is quoted in Collins, *Liftoff*, p. 31.
30. Some readers may be surprised by this reference to a "sidearm controller" for the X-15 "space plane" and Mercury spacecraft simulator if they associate the original development of sidearm-control technology with the much ballyhooed and supposedly altogether new electronic flight control systems of the 1980s. The history of the sidearm controller goes back at least to German research into new flight control systems for their advanced fighter aircraft of World War II. For those interested in this specialized technical topic, see the short bibliography compiled by engineer Paul E. Hunt of Langley's 8-Foot Tunnels Branch in 1959, on early (post-World War II) American research into sidearm flight controls, NACA/NASA card file, Langley Technical Library.
31. STG script, "Project Mercury," pp. 1–4.

32. Ibid., pp. 1 and 3.
33. The phrase that the STG treated the Mercury astronauts as “active and valuable participants” is from Collins, *Liftoff*, p. 48. Mike Collins was not part of Project Mercury, but as an astronaut in the follow-up Gemini and Apollo programs, he became very familiar with the experiences, good and bad, of the original seven astronauts. For Gilruth’s experiences in flight testing, see the early sections of his “Memoir” as well as the analysis in my *Engineer in Charge*, NASA SP-4305 (Washington, 1987), pp. 262–270 and 275–278. Gilruth’s systematic and quantified approach to aircraft flight testing is also featured prominently in chap. 3 of Walter G. Vincenti, *What Engineers Know and How They Know It: Analytical Studies from Aeronautical History* (Baltimore: Johns Hopkins University Press, 1990); chap. 3 is entitled, “Establishment of Design Requirements: Flying-Quality Specifications for American Aircraft, 1918–1943.”
34. “Capsule Built at Langley and Lewis Launched Atop Atlas in Mercury Test,” *Langley Air Scoop*, 11 Sept. 1958. On the history of Big Joe, see Swenson, Grimwood, and Alexander, *This New Ocean*, pp. 125–128.
35. STG script, “Project Mercury,” pp. 4–5.
36. Gilruth, “Memoir,” p. 46. On the history of Little Joe, see Swenson, Grimwood, and Alexander, *This New Ocean*, esp. pp. 124–126, 208–213, and 291–294.
37. Swenson, Grimwood, and Alexander, *This New Ocean*, pp. 208–209.
38. Ibid., pp. 210–213. For a contemporary news magazine story, see “Little Joe Launch Tests Mercury Capsule Escape,” *Aviation Week*, 14 Dec. 1959. For a former astronaut’s thoughtful summary of the role played by chimpanzees and other primates in Project Mercury, see Collins, *Liftoff*, pp. 48 and 51–52.
39. Gilruth, “Memoir,” p. 43.

Chapter 3

Carrying Out the Task

1. Robert R. Gilruth, “Memoir: From Wallops Island to Mercury, 1945–1958,” unpublished manuscript presented at the Sixth International History Symposium, Vienna, Austria, 13 Oct. 1992, p. 38, copy in LHA. In the OHC, LHA, is a barely audible copy of my tape-recorded interview with Gilruth at his home at Kilmarnock, Va., 10 July 1986. This interview, which lasted for over three hours, covers important aspects of Gilruth’s entire NACA/NASA career.

On Presidential Science Adviser Kistiakowsky and ARPA’s contrasting positions on the early space program, see Walter A. McDougall, *The Heavens and the Earth: A Political History of the Space Age* (New York: Basic Books, 1985), pp. 202–205. On ARPA specifically, see pp. 195–198 and 201–206.

2. Gilruth, “Memoir,” pp. 34–39; Loyd S. Swenson, Jr., James M. Grimwood, and Charles C. Alexander, *This New Ocean: A History of Project Mercury*, NASA SP-4201 (Washington, 1966), pp. 110–116; Michael Collins, *Liftoff: The Story of America’s Adventure in Space* (New York: NASA/Grove Press, 1988), p. 28.
3. Charles Zimmerman interview with author, 1 Aug. 1990, Hampton, Va., transcript, pp. 5–6, OHC, LHA.
4. Gilruth, “Memoir,” pp. 38–39.

Notes for Chapter 3

5. The key technical paper was H. J. Allen and A. J. Eggers, Jr., "A Study of the Motion and Aerodynamic Heating of Ballistic Missiles Entering the Earth's Atmosphere at High Supersonic Speeds," NACA Conf. Research Memo. A53D28, Aug. 1953. Five years later, in 1958, the NACA issued updated versions of the original report as NACA TN-4047 and NACA TR-1381. For historical analysis of the blunt-body concept, see Edwin P. Hartmann, *Adventures in Research: A History of Ames Research Center, 1940-1965*, NASA SP-4302 (Washington, 1970), p. 218; Elizabeth A. Muenger, *Searching the Horizon: A History of Ames Research Center, 1940-1976*, NASA SP-4304 (Washington, 1985), pp. 66-68; Alex Roland, *Model Research: The National Advisory Committee for Aeronautics, 1915-1958*, 2 vols., NASA SP-4103 (Washington, 1985), 1:285-286; Collins, *Liftoff*, p. 24; and James R. Hansen, *Engineer in Charge: A History of Langley Aeronautical Laboratory, 1917-1958*, NASA SP-4305 (Washington, 1987), pp. 349-350 and 358-361.
6. PARD engineers J. Thomas Markley and Max Faget are quoted in Charles Murray and Catherine Bly Cox, *Apollo: The Race to the Moon* (New York: Touchstone Books, 1989), pp. 39-40. Faget analyzed the Mercury capsule design in "Mercury Capsule and Its Flight Systems," *Aero/Space Engineering* 19 (Apr. 1960): 48-53. Charles Donlan speaks highly of Faget and his contributions to the Mercury spacecraft design: "Max was a very ingenious fellow. He had some novel and sound ideas, for the most part, a good engineer. The original ballistic capsule approach came out of Harvey Allen's work. But as a simple, quick way to get the job done, I think the Mercury capsule came [from] Max, and [from] Caldwell Johnson." Donlan interview with author, Hampton, Va., 17 Aug. 1990, transcript, p. 28, OHC, LHA. Langley veteran Charles Zimmerman seconds Donlan's appraisal of Faget: "I don't think Max Faget has ever gotten the credit he deserved in this project." Zimmerman interview with author, 1 Aug. 1990, p. 14. Many references to Faget's contributions to Project Mercury may be found in Swenson, Grimwood, and Alexander, *This New Ocean*.
7. The NACA published the Faget-Garland-Buglia paper on nonlifting, wingless satellites in *NACA Conference on High-Speed Aerodynamics, Ames Aeronautical Laboratory, Moffett Field, Calif., March 18, 19, and 20, 1958: A Compilation of Papers Presented* (NACA: Washington, 1958), p. 19ff.
8. Gilruth, "Memoir," p. 32.
9. *Ibid.*, p. 33. It is easy to confuse Matthews' concept with the winged reentry vehicle concepts championed by Langley's hypersonics specialist John V. Becker, as the two researchers' theoretical findings were combined for various analytical purposes beginning in 1957. For detailed information on Becker's early space plane concepts, see his autobiographical "The Development of Winged Reentry Vehicles, 1952-1963," 23 May 1983. A copy of this manuscript is preserved in the LHA. Becker's pioneering ideas for hypersonic gliders and transatmospheric vehicles are featured prominently in Hansen, *Engineer in Charge*, esp. pp. 367-373 and 377-381. On Becker's winged manned satellite proposal in 1957-1958, see also Swenson, Grimwood, and Alexander, *This New Ocean*, p. 89.
10. Gilruth, "Memoir," p. 34. John V. Becker offers what might be interpreted as a mild dissent from this consensus in "The Development of Winged Reentry Vehicles," p. 34.
11. Gilruth quoted in Collins, *Liftoff*, p. 61.

Notes for Chapter 3

12. Gilruth interview, 10 July 1986. See also Gilruth, "Memoir," p. 41; and Donlan interview, 17 Aug. 1990, p. 7.
13. Jack C. Heberlig interview with Robert B. Merrifield, Oct. 1967, quoted in comment draft of Dr. Merrifield's history of the early years of NASA's Manned Spacecraft Center in Houston, Tex., dated 16 Feb. 1970, chap. 3, p. 11. Merrifield's unpublished manuscript provides a thorough and thoughtful account of the history of the STG and its move from Virginia to Texas. A copy of the comment draft of his manuscript is preserved in the LHA. I do not know why Merrifield's work, which was sponsored by NASA, was never published.
14. Robert R. Gilruth to Associate Director Floyd L. Thompson, "Space Task Group," 3 Nov. 1958. A copy of this document can be found in the Floyd L. Thompson Collection in the LHA. With the memorandum is a cover sheet with a handwritten note from Thompson to Administrative Chief Officer T. Melvin Butler saying "For prompt action. *Important—Do Not Destroy.*" See also the earlier document from Langley's Paul E. Purser to Gilruth, "Initial hiring of personnel for Space Center," 3 Sept. 1958, also in the Thompson Collection. Both memoranda are in the folder labeled "Space Task Group, Formulation."
15. Donlan interview, 17 Aug. 1990, p. 22.
16. *Ibid.*, p. 7.
17. This quote, from an anonymous Langley engineer who was not part of the STG, is from Murray and Cox, *Apollo*, p. 30.
18. On Langley's PARD, see Gilruth, "Memoir," pp. 3–28; former Langley engineer Joseph A. Shortal's exhaustive *A New Dimension: Wallops Island Flight Test Range, The First Fifteen Years*, NASA RP-1028 (Washington, 1978); as well as Hansen, *Engineer in Charge*, esp. pp. 269–270.
On the air force's proposed Project MISS, see McDougall, *Heavens and the Earth*, p. 197; and Swenson, Grimwood, and Alexander, *This New Ocean*, p. 93.
19. Murray and Cox, *Apollo*, p. 32.
20. Donlan interview, 17 Aug. 1990, pp. 29–30.
21. Charles Zimmerman interview with Walter Bonney, 30 Mar. 1973, transcript, p. 24, OHC, LHA. See also Zimmerman interview with author, 1 Aug. 1990, pp. 5–6 and 11–13.
22. The Langley division chief is quoted in Murray and Cox, *Apollo*, p. 31. The authors do not identify him.
23. Murray and Cox, *Apollo*, p. 31.
24. *Ibid.*
25. Floyd L. Thompson, "Comments on Draft Chapters I–IV of MSC [Manned Spacecraft Center] History [Robert B. Merrifield's manuscript, see n. 13], Dated February 16, 1970," 27 Mar. 1970, p. 7. Copies of this memorandum to Dr. Eugene Emme, NASA HQA, can be found in the Thompson Collection, LHA, in a folder labeled "MSC History Comments" and in E1-3, LCF. At the time of his "Comments," Thompson was special consultant to the NASA administrator.
26. For complete internal files documenting NASA Langley's support of the STG and Project Mercury, see the correspondence in A189-5, LCF, and in the LCF's even more voluminous collection of letters filed under the project name "Mercury." See also the material in

Notes for Chapter 3

- Thompson's personal collection of "Project Mercury" papers, now preserved as part of the LHA's Thompson Collection.
27. Donlan interview, 17 Aug. 1990, pp. 32–33.
 28. Collins, *Liftoff*, p. 150. *Liftoff* is an excellent "insider" history, while Collins' *Carrying the Fire: An Astronaut's Journey* (New York: Farrar, Straus, and Giroux, 1974) is the best autobiography yet to come from anyone—astronaut or otherwise—involved in the space program.
 29. Murray and Cox, *Apollo*, p. 254. On ground control of flight tests at Edwards AFB in the late 1940s and 1950s, see Richard P. Hallion, *On the Frontier: Flight Research at Dryden, 1946–1981*, NASA SP-4303 (Washington, 1984), pt. 1.
 30. Murray and Cox, *Apollo*, p. 255.
 31. William J. Boyer interview with author, Hampton, Va., 24 Aug. 1990. This tape-recorded interview has not been transcribed, but the tape is available in the OHC, LHA.
 32. NASA Langley press release, "NASA Langley Research Center Directs Establishment of \$80 Million Tracking System for Project Mercury," 16 Aug. 1961. For analysis and more information on the tracking network, see Swenson, Grimwood, and Alexander, *This New Ocean*, esp. pp. 213–221.
 33. Murray and Cox, *Apollo*, p. 255.
 34. Boyer interview, 24 Aug. 1990. On Goddard's responsibility for Minitrack, see *This New Ocean*, p. 146; and Alfred Rosenthal, *Venture into Space: Early Years of Goddard Space Flight Center*, NASA SP-4301 (Washington, 1968), pp. 65–66.
 35. Boyer interview, 24 Aug. 1990.
 36. Paul Vavra interview with Robert B. Merrifield, quoted in Merrifield's manuscript, chap. 3, p. 39 n. 74.
 37. See the Western Electric Company's *Final Progress Report to NASA: Project Mercury, Contract Number NAS 1-430* (June 1961), copy in Project Mercury files, LHA.
 38. Boyer interview, 24 Aug. 1990.
 39. Edmond C. Buckley, director, Tracking and Data Acquisition, NASA headquarters, to Floyd L. Thompson, director, NASA Langley, 27 Feb. 1962, E1-2C, LCF. Another copy of this letter is in the folder labeled "Mercury Tracking Range" that is part of the Thompson Collection in the LHA.
 40. *Ibid.*
 41. Gilruth, "Memoir," p. 47. Reflecting on Thompson's agreement with Gilruth, Caldwell Johnson has jested that all STG members to this day "wonder which half they were in," the half Gilruth wanted or the half Thompson wanted to give away.
 42. Thompson, "Comments on Draft Chapters," p. 7.
 43. Donlan interview, 17 Aug. 1990, p. 17.
 44. Thompson, "Comments on Draft Chapters," pp. 7–8.
 45. Laurence K. Loftin, Jr., interview with author, Newport News, Va., 26 June 1990, OHC, LHA.
 46. Donlan interview, 17 Aug. 1990, pp. 27–28.
 47. Thompson, "Comments on Draft Chapters," p. 8.
 48. Merrifield's manuscript, chap. 3, pp. 61–64. See also Swenson, Grimwood, and Alexander, *This New Ocean*, pp. 251–253. The official moves to lessen STG's dependence on Langley can be followed in the Langley correspondence files: Code A189–5 and "Mercury."

Notes for Chapter 3

49. On the difficult genesis of Goddard Space Flight Center, see Rosenthal, *Venture into Space*, pp. 27–35, and Robert L. Rosholt, *An Administrative History of NASA, 1958–1963*, NASA SP-4101 (Washington, 1966), p. 79.
50. Donlan interview, 17 Aug. 1990, p. 15.
51. *Ibid.*, pp. 16–17.
52. Swenson, Grimwood, and Alexander, *This New Ocean*, pp. 390–392; Murray and Cox, *Apollo*, pp. 130–132; McDougall, *Heavens and the Earth*, pp. 373–374; Merrifield manuscript, chap. 4, pp. 21–33.
53. Joe Stein, NASA headquarters news release, “Manned Space Flight Laboratory Location Study Completed,” 19 Sept. 1961. Constant rumors of the STG’s impending move appeared in the Hampton Roads newspapers for weeks; see, for example, Bill Delany, “Mercury Unit Move Rumors Cited by NASA as ‘Unofficial Reports,’ ” *Newport News (Va.) Daily Press*, 30 May 1961.
54. Editorial, “A Terrible Waste of Time and Money,” *Newport News Daily Press*, 27 June 1961. So disturbed were members of the Peninsula Chamber of Commerce (PCC) that they launched a campaign of letter writing, petitioning, and lobbying to keep the STG where it was. Leading the “call to arms,” was a special subcommittee of the PCC’s legislative committee whose members worked in conjunction with the efforts of home district Congressman Thomas N. Downing. Members of this “Save the STG” subcommittee included local newspaper magnate William R. Van Buren; prominent real estate broker John P. Yancey (the subcommittee’s chairman); Charles K. Hutchens, delegate to the Virginia General Assembly; Mayor O. J. Brittingham, Jr., of Newport News; Mayor George C. Bentley of Hampton; Mayor G. S. Forrest of Poquoson; Rodger Smith of the York County Board of Supervisors; Leslie O’Hara, a PCC director; Frank Floyd, co-manager of the Peninsula Shipbuilders Association; and Irving L. Fuller, the PCC’s executive vice-president. The local newspapers, besides staying on top of rumors and NASA statements about the STG’s relocation, reported regularly on the actions of this special committee. One can follow the outline of the losing battle to keep the STG at Langley from the late spring to the early fall of 1961 in articles from the *Newport News Daily Press* from 1 June through 21 Sept.
55. Caldwell Johnson quoted in Murray and Cox, *Apollo*, p. 131.
56. Donlan interview, 17 Aug. 1990, p. 39.
57. *Ibid.*, pp. 39–40.
58. *Ibid.*, p. 23.
59. See the day-to-day correspondence from this period pertaining to STG activities in A189-5, LCF. For the details of the Glenn and Carpenter flights, see Swenson, Grimwood, and Alexander, *This New Ocean*, pp. 422–436 (Glenn’s Mercury-Atlas 6 flight in *Friendship 7*, 20 Feb. 1962) and 446–460 (Carpenter’s Mercury-Atlas 7 flight in *Aurora 7*, 24 May 1962). For a more popular and abbreviated history, see Collins, *Liftoff*, pp. 52–57.
60. This letter was quoted at length in “Gilruth Thanks Langley Staff for Support of Project Mercury,” *Langley Researcher*, 5 July 1963.
61. My account is derived from the following articles in the *Newport News Daily Press*: “Saturday’s Tribute to Astronauts Set,” 13 Mar. 1962; “Sen. Byrd Accepts Invitation to Program Honoring Space ‘Team,’ Parade Route Set,” 14 Mar. 1962; “State to Pay

Notes for Chapter 4

- Tribute to Project Mercury Space 'Team' Today," 17 Mar. 1962; "Seven Astronauts Get Rousing; Peninsula Throng Hails Project Mercury Team," 18 Mar. 1962; "Respect, Awe Mix with Pride as Peninsula Pays Its Respects to America's Astronauts," 18 Mar. 1962.
62. Parke Rouse, Jr., *The Good Old Days in Hampton and Newport News* (Richmond: Dietz Press, 1986), p. 69.

Chapter 4

Change and Continuity

1. Various people have related this story to me, notably Edgar M. Cortright in a July 1988 interview, Yorktown, Va., transcript, pp. 9–10, OHC, LHA, and Laurence K. Loftin, Jr., in a July 1990 interview, Newport News, Va. The versions told by Cortright and Loftin are virtually identical in the details of the incident; however, Cortright, who at the time of the incident was the deputy director of the Office of Lunar and Planetary Programs at NASA headquarters, tells the story with an implicit criticism of Thompson's behavior. Loftin, Thompson's assistant director, praises the boldness and independence of his center director. Cortright witnessed the incident; Loftin heard about it.
2. Dr. John E. Duberg interview with author, Hampton, Va., 8 Aug. 1991.
3. Senator John F. Kennedy quoted in Michael Collins, *Liftoff: The Story of America's Adventure in Space* (New York: NASA/Grove Press, 1988), p. 63.
4. For a critique of Webb's approach to the management of NASA and its application to other arenas of American life, see Walter A. McDougall, *The Heavens and the Earth: A Political History of the Space Age* (New York: Basic Books, 1985), pp. 380–383.
5. Quoted in McDougall, *Heavens and the Earth*, p. 383, from Webb's remarks to a "Conference on Space, Science, and Urban Life," held at the Dunsmuir House, Oakland, Calif., 30 Mar. 1963.
6. My presentation of the general character of Langley's formal organization in the 1960s is based on my study of organization charts, correspondence pertaining to the formal organization found in file E26-3C, LCF, and a staff office notebook that chronicles the major organizational changes at Langley from World War II to the present. This notebook, in the LHA, has been kept up-to-date in recent years by Langley historical program coordinator Richard T. Layman.
7. Langley Announcement, No. 7-62, "Reorganization of Langley Research Center," 16 Feb. 1962, E26-3C, LCF.
8. Ira H. Abbott, director of Advanced Research Programs, to Langley, Attn.: F. L. Thompson, "Establishment of an Analysis and Computation Division at the Langley Research Center, and authorization to appoint a division chief for the new division," 13 Dec. 1960, E26-3C, LCF.
9. For the complete history of PARD, see Joseph A. Shortal's exhaustive *A New Dimension: Wallops Flight Test Range, The First Fifteen Years*, NASA RP-1028 (Washington, 1978). For a shorter treatment with special emphasis on PARD's role as a training ground for space, see Robert R. Gilruth, "Memoir: From Wallops Island to Mercury, 1945–1958," unpublished manuscript presented at the Sixth International History Symposium, Vienna, Austria, 13 Oct. 1972, copy in LHA.

10. Duberg interview, 8 Aug. 1991. For some interesting history related to the “maverick” character of PARD, see Henry S. F. Cooper’s essay, “We Don’t Have to Prove Ourselves,” in *The New Yorker*, 2 Sept. 1991, esp. pp. 57–58. Dr. Cooper’s article tells the story of former PARD employees Maxime A. Faget and Caldwell Johnson; after working on the STG, the two NACA/NASA engineers went on to operate their own company, Space Industries International, on the outskirts of Johnson Space Center.
11. Cortright interview, July 1988, esp. pp. 1–6. On NACA Director George Lewis and his paternalistic and obfuscatory style of management, see James R. Hansen, *Engineer in Charge: A History of the Langley Aeronautical Laboratory, 1917–1958*, NASA SP-4305 (Washington, 1987), pp. 24–40, and “George W. Lewis and the Management of Aeronautical Research,” in *Aviation’s Golden Age: Portraits from the 1920s and 1930s*, ed. William M. Leary (Iowa City: University of Iowa Press, 1989), pp. 93–112.
12. Laurence K. Loftin, Jr., interview with author, Newport News, Va., 26 June 1991.
13. *Ibid.*
14. Israel Taback quoted in James Schultz, *Winds of Change: Langley Research Center’s 75 Years of Accomplishment*, NP-130 (Washington, 1992), p. 21.
15. On the dissolution of the Hydrodynamics Division, see H. J. E. Reid, internal memorandum for all concerned, “Changes in Organization of the Langley Research Center,” 23 Dec. 1959, E26-3C, LCF.
16. For a brief history of Langley’s hydrodynamics work, see the NASA Langley press release, “Changing Research Emphasis Leads to Dissolution of NASA’s Hydrodynamics Division after 29 Years,” 29 Dec. 1959, E26-3C, LCF. For design information on the Martin YP6M-1 Seamaster jet-propelled flying boat, see Laurence K. Loftin, Jr., *Quest for Performance: The Evolution of Modern Aircraft*, NASA SP-468 (Washington, 1985), pp. 382–385. For basic information about Convair’s Sea Dart, see Ray Wagner, *American Combat Planes*, 3d enlarged ed. (Garden City, N.Y.: Doubleday & Co., 1982), pp. 515–517.
17. See H. J. E. Reid to NASA headquarters, “Proposed Reorganization of Langley Research Center and Changes in Excepted Positions,” 16 Dec. 1959, E26-3C, LCF. For Parkinson’s principal work on the hydrodynamics of seaplanes, see his “Appreciation and Determination of the Hydrodynamics Qualities of Seaplanes,” NACA TN-1290, 1947.
18. On the NACA Tank No. 1, see Starr Truscott, “The NACA Tank—A High-Speed Towing Basin for Testing Models of Seaplane Floats,” NACA TR-470, 1933. For an excellent detailed presentation on the nature and contributions of Langley’s Hydrodynamics Research Division in the 1930s and early 1940s, see “Air and Water,” in George W. Gray, *Frontiers of Flight: The Story of NACA Research* (New York: Alfred A. Knopf, 1948), pp. 63–81. For the history of flying boats, see Kenneth Munson, *Flying Boats and Seaplanes Since 1910* (New York: Macmillan Co., 1971); and Capt. Richard C. Knott, *The American Flying Boat, An Illustrated History* (Annapolis: Naval Institute Press, 1979). On the floatplanes of World War II specifically, see Wagner, *American Combat Planes*, pp. 334–345.
19. On the U.S. Navy’s termination of its flying-boat program in the late 1950s, see Loftin, *Quest for Performance*, p. 385, and Wagner, *American Combat Planes*, p. 481.
20. Reid, “Changes in Organization of Langley Research Center,” 23 Dec. 1959.
21. Quoted in NASA Langley press release, “Changing Research Emphasis,” p. 1.

Notes for Chapter 4

22. Laurence K. Loftin, Jr., interview with author, Newport News, Va., 5 Aug. 1989, transcript, p. 5, OHC, LHA.
23. Raymond L. Bisplinghoff, "Twenty-Five Years of NASA Aeronautical Research: Reflections and Projections," in *Space Applications at the Crossroads: 21st Goddard Memorial Symposium*, eds. John H. McElroy and E. Larry Heacock (San Diego: Published for the American Astronautical Society by Univelt, 1983), pp. 30–31.
24. John V. Becker, "The Development of Winged Reentry Vehicles, 1952–1963," unpublished, 23 May 1983, p. 31, copy in LHA.
25. Ibid.
26. Mark R. Nichols interview with author, Hampton, Va., 6 July 1988, transcript, pp. 2–3, OHC, LHA.
27. All of the statistical information in this chapter regarding personnel, payroll, budget, expenditures, and so forth is from the *NASA Historical Data Book*, NASA SP-4012 (Washington, 1988), vol. 1, *NASA Resources 1958–1968*, by Jane Van Nimmen and Leonard Bruno with help from Robert L. Rosholt. NASA personnel statistics given in various sources may seem contradictory. The *NASA Historical Data Book* gives certain personnel numbers for a given year, and the *NASA Historical Pocket Statistics* may give others. Neither is in error; the differences depend on *when* the count was taken. The number of NASA employees changed every day. The *NASA Historical Data Book*, vol. 1, *NASA Resources 1958–1968*, which is my source, provides personnel statistics for 30 June and 31 Dec. of each year.
28. Earl D. Hilburn, deputy associate administrator, NASA headquarters, to Dr. Floyd L. Thompson, 16 Aug. 1963, copy in C131-1, LCF. Floyd L. Thompson to NASA headquarters, "Manpower Requirements," 9 Sept. 1963, C131-1, LCF.
29. On NASA's early problems involving the low ceiling on its personnel complement, see Robert L. Rosholt, *An Administrative History of NASA, 1958–1963*, NASA SP-4101 (Washington, 1966), pp. 139–141.
30. See the summary of the NASA Staff Conference, Monterey, Calif., 3–5 Mar. 1960, p. 56, copy in NASA HQA. Glennan's views are outlined in Rosholt, *Administrative History of NASA*, p. 140.
31. Rosholt compared Glennan's 1962 "Budget Guidelines" with the "Summary Financial Plan for Fiscal Year 1961, NASA," that NASA submitted to the Bureau of the Budget on 19 Aug. 1960, *Administrative History of NASA*, p. 140.
32. Roger E. Bilstein, *Orders of Magnitude: A History of the NACA and NASA, 1915–1990*, NASA SP-4406 (Washington, 1989), p. 71.
33. See Hilburn to Thompson, 16 Aug. 1963.
34. Thompson to NASA headquarters, "Manpower Requirements," 9 Sept. 1963.
35. Axel T. Mattson, research assistant for Manned Spacecraft Projects, Langley, to Manned Spacecraft Center, Attn.: Mr. M. A. Faget, "Langley Research Center Tests of Interest to Manned Spacecraft Center," 27 Aug. 1963. Mattson compiled these reports regularly from late 1962 into 1967. Copies of them are preserved in the Project Apollo files, LCF. Their contents will be discussed in chap. 11 in relation to Langley's work in support of Apollo.
36. See Table 4-19, "Administrative Operations Direct Obligations, by Installation (in millions of dollars)," in *NASA Historical Data Book*, 1:146.

37. For a general analysis of how procurement and contracting were done by NASA in its early years, see Rosholt, *Administrative History of NASA*, pp. 61–65, and Arnold S. Levine, *Managing NASA in the Apollo Era*, NASA SP-4102 (Washington, 1982), pp. 65–105. On the allocation of resources by NASA headquarters, see Levine, pp. 63–64.
38. See Table 5-19, “Value of Awards by Installation (in millions of dollars),” *NASA Historical Data Book*, 1:202.
39. See Table 4-26, “Amounts Programmed for Research and Development, by Installation (in millions of dollars),” *NASA Historical Data Book*, 1:166.
40. See tables 5-20 through 5-27 of the *NASA Historical Data Book*, 1:203–226, for detailed information on NASA contracts and contractors in the period 1958 to 1968.
41. Steven T. and Sarah W. Corneliussen, “NASA Langley Research Center Support Services Contracting, Historical Summary,” 29 May 1991, p. 1. Much of the discussion about the history of support services contracting at Langley that follows in this chapter is based on the unpublished Corneliussen study or on the oral histories they conducted for it. A copy of this study and all the materials collected for it are preserved in the LHA.
42. Duberg interview, 8 Aug. 1991.
43. Corneliussen and Corneliussen, “Support Services Contracting,” p. 6. For an analysis of support services and the issue of the integrity of the NASA civil service staff, see Levine, *Managing NASA in the Apollo Era*, pp. 86–87.
44. Corneliussen and Corneliussen, “Support Services Contracting,” pp. 9–10.
45. For definitions of the various types of contracts authorized by NASA, see app. D of Levine, *Managing NASA in the Apollo Era*, pp. 313–314. Levine’s definitions are based on House Committee on Science and Astronautics, *1965 NASA Authorization*, 88th Cong., 2d sess. (1964), pp. 1327–1328.
46. Levine, *Managing NASA in the Apollo Era*, app. D, p. 313.
47. Corneliussen and Corneliussen, “Support Services Contracting,” p. 17.
48. Edwin Kilgore interview with Steven T. Corneliussen, Hampton, Va., Apr. 1991, LHA.
49. Sherwood Butler interview with Sarah W. Corneliussen, Hampton, Va., Apr. 1991, LHA.
50. Robert Moore interview with Sarah W. Corneliussen, Hampton, Va., Apr. 1991, LHA.
51. On the American atomic bomb project, see H. D. Smyth, *Atomic Energy* (Washington: Government Printing Office, 1945); this is the original official report. For a very readable historical analysis, see Stephane Groueff, *Manhattan Project: The Untold Story of the Making of the Bomb* (Boston: Little, Brown & Co., 1967), and Richard Rhodes, *The Making of the Atomic Bomb* (New York: Simon & Schuster, 1986). See also R. G. Hewlett and O. E. Anderson, *A History of the United States Atomic Energy Commission* (Pennsylvania State University Press, 1962), vol. 1, *The New World*.
On Project Sherwood and the history of the program in controlled thermonuclear reactions carried out by the U.S. Atomic Energy Commission during the period 1951 to 1958, see Amasa Bishop, *Project Sherwood: The U.S. Program in Controlled Fusion* (Reading, Mass.: Addison-Wesley Publishing Co., 1958), and Joan Lisa Bromberg, *Fusion: Science, Politics, and the Invention of a New Energy Source* (Cambridge, Mass.: MIT Press, 1983.)
52. *NASA Management Manual*, pt. 1, “General Management Instructions,” chap. 4, No. 4-1-1, 8 Mar. 1963, p. 1.

Notes for Chapter 5

53. On the administrative evolution of Apollo from a project to a program, see Levine, *Managing NASA in the Apollo Era*.
54. National Research Council, *NASA's Aeronautics Research and Technology Base: A Study of the Report of the Ad Hoc Aeronautics Research Committee, Aeronautics and Space Engineering Board* (Washington: National Academy of Sciences, 1979), p. 6.
55. On the NACA/NASA work on the XB-70 and XB-70A, see Richard P. Hallion, *On the Frontier: Flight Research at Dryden, 1946-1981*, NASA SP-4303 (Washington, 1984), pp. 180-189.
56. John V. Becker, *High-Speed Frontier: Case Histories of Four NACA Programs, 1920-1950*, NASA SP-445 (Washington, 1980), pp. 86-87. For more on the feelings of other Langley divisions about PARD, see Hansen, *Engineer in Charge*, pp. 269-270.
57. Macon C. Ellis, Jr., interview with author, Hampton, Va., 5 Nov. 1991.
58. Loftin telephone interview with author, 30 Jan. 1992.
59. Charles J. Donlan interview with author, Hampton, Va., 17 Aug. 1990, transcript, pp. 27-28, OHC, LHA.
60. Rosholt, *Administrative History of NASA*, pp. 145-146.
61. *Ibid.*
62. *Ibid.*, pp. 157-158.
63. Levine, *Managing NASA in the Apollo Era*, pp. 43-45.
64. What has been described in the text is a system of project management that evolved gradually, in fits and starts, through several major reorganizations taking place during the first five years of NASA, from October 1958 to October 1963. For a far more comprehensive examination of the development of the NASA organization and its management in this period, the reader should consult the previously cited works by Rosholt and Levine. Both books go into great detail about NASA's project management.
65. On the nature of the wartime work at NACA Langley, see Hansen, *Engineer in Charge*, pp. 194-202.

Chapter 5

The "Mad Scientists" of MPD

1. The scientific and technical literature generated by the field of plasma physics since its emergence as an identifiable scientific discipline in the 1950s is too vast to cite. For basic technical information about the field provided in this chapter, I have primarily used a well-known textbook from the early 1960s, Ali Bulent Cambel, *Plasma Physics and Magneto-fluid-Mechanics* (New York: McGraw-Hill, 1963) and one NASA publication by Langley authors Adolf Busemann, Robert V. Hess, Paul W. Huber, Clifford H. Nelson, and Macon C. Ellis, Jr., *Plasma Physics and Magnetohydrodynamics in Space Exploration*, NASA SP-25 (Washington, 1962). These papers were originally presented by their authors at a NASA/University Conference on the Science and Technology of Space Exploration, Chicago, Ill., 1-3 Nov. 1962. Ironically, in the midst of using Cambel's book, I discovered that the MPD Branch at Langley did not care for Cambel, a physics professor at Northwestern University in Evanston, Ill. In the 1960s, the head of the MPD Branch, Macon C. Ellis, Jr., turned down more than one of Cambel's ideas for doing MPD research under contract to Langley.

- For a more basic discussion of the nature of gases and plasma than can be found in the Cambel textbook, consult, as I did, Paul G. Hewitt, *Conceptual Physics*, 6th ed. (Glenview, Ill.: Scott, Foresman and Co., 1989), pp. 244–246; Gary L. Buckwalter and David M. Riban, *College Physics* (New York: McGraw-Hill, 1987), pp. 832–835; or some other textbook in physics.
2. See Thomas G. Cowling, *Magnetohydrodynamics* (London: Adam Hilger, 1976), pp. 1–2. However, the best discussion of the confounding nomenclature of plasma physics can be found in the introduction to an unpublished paper by Langley MPD researcher George P. Wood. A copy of this paper, which is undated (but seems to have been written in 1959), can be found in the collection of personal papers donated in 1991 to the LHA by Macon C. Ellis, Jr.
 3. For a historical analysis of Chapman’s work on solar physics and solar and terrestrial relationships, see Karl Hufbauer, *Exploring the Sun: Solar Science Since Galileo* (Baltimore and London: Johns Hopkins University Press, 1991), esp. pp. 154–158 and 217–221. Several references are made to the contributions of the Chapman group in Homer Newell, *Beyond the Atmosphere: Early Years of Space Science*, NASA SP-4211 (Washington, 1980).
 4. For those interested in the many complex details of Alfvén’s work, see Alfvén, *Cosmical Electrodynamics* (Oxford University Press, 1950). Also see Hufbauer, *Exploring the Sun*, pp. 205–206, 216, 242, 253, and 311.
 5. For details about the discovery of the earth’s radiation belts from the scientist who discovered them, see James Van Allen, *The Origins of Magnetospheric Physics* (Washington: Smithsonian Institution Press, 1983). For a brief historical analysis of the discovery of the Van Allen radiation belts, see Newell, *Beyond the Atmosphere*, esp. pp. 173–176; Hufbauer, *Exploring the Sun*, pp. 165–166; Roger Bilstein, *Orders of Magnitude: A History of the NACA and NASA, 1915–1990*, NASA SP-4406 (Washington, 1989), pp. 46–47 and 81–82; and John E. Naugle, *First Among Equals: The Selection of NASA Space Science Experiments*, NASA SP-4215 (Washington, 1991), pp. 15–17.
 6. On the emergence of the concept of the magnetosphere, see Van Allen, *The Origins of Magnetospheric Physics*; Newell, *Beyond the Atmosphere*, pp. 172–186; and Hufbauer, *Exploring the Sun*, pp. 228, 235, and 240–243.
 7. Newell, *Beyond the Atmosphere*, pp. 182–184. On Eugene Parker’s theory of the solar wind and its impact on astrophysics and solar science from 1957 to 1970, see chap. 6 in Hufbauer, *Exploring the Sun*, pp. 213–258.
 8. In response to questions that the author had posed to him in a letter, retired NACA/NASA researcher Macon C. Ellis, Jr., in early Nov. 1991 tape-recorded answers and provided other oral reminiscences concerning the history of MPD at Langley. The information contained on the roughly 90-minute tape provides an excellent overview of MPD research at Langley. However, because of the candid nature of some of the remarks made about fellow MPD personnel, Ellis chose to restrict access to the tape. This he did by giving the tape to the author for his personal use and asking that a copy not be placed in the LHA. The quotation from Ellis in the text is from the author’s handwritten transcript of this audiotape, p. 2.
 9. Quoted from Ellis’s handwritten notes entitled “Branch Re-Cap,” for a meeting of the Compressibility Research Division on 18 June 1958, p. 1. The branch referred to was the

Notes for Chapter 5

Gas Dynamics Branch. These notes are in a folder labeled "Editorial Copy, 1958," Ellis Collection, LHA.

10. A significant amount of MPD-related research was conducted at the other NASA research centers. For example, a parallel MPD branch at Lewis was especially interested in the promise of ion thrusters and electric propulsion. The best sources for NASA's early MPD activities agencywide are the published reports of the intercenter conferences on plasma physics; see, for example, *Program of the Third NASA Intercenter Conference on Magnetoplasmadynamics*, held at Langley, 24–25 Apr. 1962, or "*Program of the Fourth NASA Intercenter Conference on Plasma Physics*," held at NASA headquarters, 2–4 Dec. 1964. Copies of most of these NASA meeting programs are in the Ellis Collection, LHA. For a list of organizations that conducted MPD and plasma physics research, as well as for lists of the dozens of people involved, see the relevant documents in the folder labeled "Statistics on Visitors, etc.," Ellis Collection, LHA.
11. NASA Langley press release, "NASA 1959 Inspection: Magnetoplasmadynamics," Oct. 1959, p. 1, "1959–1964 Inspection" drawer, LHA.
12. Ellis audiotape, author's transcript, p. 9.
13. *Ibid.*, p. 5.
14. "Agenda and Tentative Schedule for Interlaboratory Magnetohydrodynamics Meeting, Sept. 22–23, 1958," copy in folder labeled "MHD Meeting—9-22/23-58," Ellis Collection, LHA. The folder contains several documents related to the conference. Dr. Busemann served as the "meeting chairman," and Macon C. Ellis, Jr., served as its "coordinator." Busemann continued to work on MHD-related problems throughout the early 1960s; see, for example, "On the Karman Vortex Street in Magneto-fluid-Dynamics," *80th Annual Proceedings of the Institute of Aerospace Sciences, 1962*; "Relations between Aerodynamics and Magnetohydrodynamics," which was presented at a NASA-sponsored conference at the University of Chicago, 1–3 Nov. 1962; and "Lift Control in Magnetohydrodynamics," a paper presented at the International Symposium of Applications of the Theory of Functions in Continuum Mechanics at Tbilisi in the Soviet Union, 18–24 Sept. 1963. Copies of all three papers are available in the Langley Technical Library.
15. Macon C. Ellis, Jr., to Charles J. Donlan, Langley associate director, "Outline of NASA-Postdoctoral Resident Research Associate Program Administered by National Research Council—NASA—NAE and recommendations relative to Langley participation," 29 Nov. 1966, copy in folder labeled "RRA Program," Ellis Collection, LHA. This folder contains a rather complete file on MPD's involvement in the RRA program at Langley.
16. Special personnel folders for Adamson and Feix are in the Ellis Collection, LHA.
17. For insight into the amount and type of MPD research conducted by outside groups under contract to Langley, see "MPD Branch Research Grants and Contracts," a seven-page document, dated Oct. 1966, in the Ellis Collection, LHA. MPD monitored 37 contracts amounting to almost \$4 million.

The MPD Branch collected complete information on its committee memberships, publications, contracts, and visitors in preparation for a major June 1968 briefing of new Langley Director Edgar M. Cortright. Much of this information is in a folder labeled "Statistics on Visitors, etc.," Ellis Collection, LHA.

18. NASA established a Technical Working Group for Electric Propulsion (TWGEP) on 1 Sept. 1960. Chaired by Dr. Ernst Stuhlinger of NASA Marshall, the group comprised

- representatives from Marshall, JPL, Lewis, Goddard, Langley, and NASA's Nuclear Engine Project Office. MPD Branch Head Mike Ellis was Langley's representative. The Ellis Collection contains a complete set of minutes to the TWGEP meetings. The first of these meetings convened at Marshall on 13 Oct. 1960.
19. NASA Langley press release, "NASA 1959 Inspection: Magnetoplasmadynamics," Oct. 1959, p. 1.
 20. John V. Becker interview with author, Hampton, Va., 5 Aug. 1991.
 21. Donald D. Baals and William R. Corliss, *Wind Tunnels of NASA*, NASA SP-440 (Washington, 1981), p. 85.
 22. For information on the arc-jet facilities built and operated at Langley in the 1960s, see Martin A. Weiner, *Resume of Research Facilities at the Langley Research Center* (Washington: NASA, July 1968). A copy of this catalogue (No. CN-123,837) is available in the Langley Technical Library.
 23. For more information on the hotshot tunnel, see Baals and Corliss, *Wind Tunnels of NASA*, pp. 84–85; and Weiner, *Resume of Research Facilities*, facilities in Building 1247B.
 24. William H. Allen, ed., *Dictionary of Technical Terms for Aerospace Use*, NASA SP-7 (Washington, 1965), p. 251. See also Baals and Corliss, *Wind Tunnels of NASA*, p. 84.
 25. A one-page chronology of early shock-tube operation in Langley's Gas Dynamics Laboratory from 1951 to 1953 is located in the Ellis Collection, LHA; see the folder labeled "Editorial Copy, 1958." Also in this folder is a chart (circa 1957) listing the major research facilities in the Gas Dynamics Laboratory and giving basic data on their test section sizes, running times, dates of initial operation, and stagnation temperatures and pressures. Mike Ellis used this chart and its associated information to brief a meeting of the NACA's aerodynamics committee held at Langley on 1 May 1958.
 26. Becker interview, 5 Aug. 1991. See George P. Wood and Arlen F. Carter, "Considerations in the Design of a Steady DC Plasma Accelerator," presented at the Third Biennial Gas Dynamics Symposium, Northwestern University, Evanston, Ill., 24–26 Aug. 1959, copy in the Langley Technical Library.
 27. George P. Wood, Arlen F. Carter, Alexander P. Sabol, and Richard H. Weinstein, "Experiments in Steady State Crossed-Field Acceleration of Plasma," in *Physics of Fluids* 5 (May 1961): 652; George P. Wood, Arlen F. Carter, Hubert K. Lintz, and J. Byron Pennington, "A Theoretical Treatment of the Steady-Flow, Linear, Crossed-Field, Direct-Current Plasma Accelerator for Inviscid, Adiabatic, Isothermal, Constant-Area Flow," NASA TN D-924, June 1961; Arlen F. Carter, George P. Wood, D. R. McFarland, and W. R. Weaver, "Research on a Linear Direct-Current Plasma Accelerator," in *AIAA Journal* 3 (June 1965): 1040–1045. For an earlier version of this paper, see George P. Wood, Arlen F. Carter, Alexander P. Sabol, D. R. McFarland, and W. R. Weaver, "Research on Linear Crossed-Field Steady-Flow DC Plasma Accelerators at Langley Research Center, NASA," presented at the AGARD Specialists' Meeting on Arc Heaters and MHD Accelerators for Aerodynamic Purposes, Rhode-Saint-Genése, Belgium, 21–23 Sept. 1964, published as AGARDograph 84, copy in the Langley Technical Library. For a general description of Langley's early work on plasma accelerators, see NASA Langley press release, "NASA 1959 Inspection: Magnetoplasmadynamics," pp. 2–3.
 28. Becker interview, 5 Aug. 1991.

Notes for Chapter 5

29. Ibid. A preliminary proposal for what Stack wanted to call a "Trans-Satellite-Velocity" wind tunnel can be found in the folder labeled "Editorial Copy, 1958," Ellis Collection, LHA.
30. Arlen F. Carter, Willard R. Weaver, Donald R. McFarland, Stephen K. Park, and George P. Wood, "Development and Initial Operating Characteristics of the 20-Megawatt Linear Plasma Accelerator Facility," NASA TN D-6547, Dec. 1971; see also "Design of the 20-Megawatt Linear Plasma Accelerator Facility," NASA TN D-6116, Jan. 1971, by the same authors.
31. On Langley's work with Hall-current accelerators, see John R. Sevier, Robert V. Hess, and Philip Brockman, "Coaxial Hall-Current Accelerator Operation at Forces and Efficiencies Comparable to Conventional Crossed-Field Accelerators," in *ARS Journal* 32 (Jan. 1962): 78–80; Philip Brockman, Robert V. Hess, and Richard Weinstein, "Measurements and Theoretical Interpretation of Hall Currents for Steady Axial Discharges in Radial Magnetic Fields," presented at the Fifth Biennial Gas Dynamics Symposium, Northwestern University, Evanston, Ill., 14–16 Aug. 1963; W. Grossmann, H. A. Hassan, and R. V. Hess, "Experiments with Co-Axial Hall-Current Plasma Accelerator," presented at AIAA Fourth Electric Propulsion Conference, Philadelphia, 31 Aug.–2 Sept. 1964; H. A. Hassan, R. V. Hess, and W. Grossmann, "Study of Coaxial Hall Current Accelerators at Moderate Pressures," NASA TN D-3286, Oct. 1966. Copies of all these papers are available in the Langley Technical Library. The author wishes to thank Mr. Hess for his generous assistance in explaining, via letters, telephone conversations, and personal interviews, the development of the MPD accelerators at Langley.
32. Robert V. Hess and Macon C. Ellis, Jr., to Floyd L. Thompson, associate director, "Visit to the Research Institute of Temple University, Philadelphia, Pa., to discuss high temperature flames," 21 June 1959, copy in folder labeled "CN (Early)," Ellis Collection, LHA. Three folders containing material on Langley's development of a cyanogen flame apparatus are in the Ellis Collection, LHA. Ellis also comments on the cyanogen flame apparatus in his audiotape, author's transcript, p. 4.
33. NASA Langley press release, "NASA 1959 Inspection: Magnetoplasmadynamics," pp. 1–2. For the early experimental findings involving the Langley cyanogen flame apparatus, see Paul W. Huber and Paul B. Gooderum, "Experiments with Plasmas Produced by Potassium-Seeded Cyanogen Oxygen Flames for Study of Radio Transmission at Simulated Reentry Vehicle Plasma Conditions," NASA TN D-627, Oct. 1961. See also Huber, "Experiments with Plasmas Produced by Alkali-Metal-Seeded Cyanogen-Oxygen Flames for Study of Electromagnetic Wave Propagation at the Langley Research Center," paper presented at the Symposium on the Plasma Sheath, Cambridge, Mass., 7–9 Dec. 1959, copy in the Langley Technical Library.

Calvin T. Swift's major MPD research papers from the period include "Generalized Treatment of Plane Electromagnetic Waves Passing through an Isotropic Inhomogeneous Plasma Slab at Arbitrary Angles of Incidence," NASA TR R-172, Dec. 1963, coauthored by J. S. Evans; "Radiation from Slotted-Cylinder Antennas in a Reentry Plasma Environment," NASA TN D-2187, Feb. 1964; "The Aperture Admittance of a Ground Plane-Mounted Waveguide Illuminating a Perfectly Conducting Sheet," NASA TN D-4366, Mar. 1968, coauthored by J. Earl Jones; "Experimental Investigation of a Plasma

- Covered, Axially Slotted Cylinder,” in *IEEE Transactions on Antennas and Propagation* 17 (Sept. 1969): 598–605, coauthored by P. B. Gooderum and S. L. Castellow, Jr.; and “A Theoretical Investigation of Electromagnetic Waves Obliquely Incident Upon a Plasma Slab,” NASA TR R-339, Apr. 1970.
34. Very little can be found in any publications of the NASA History Series about Project RAM. The *NASA Historical Data Book*, vol. 2, *Programs and Projects, 1958–1968*, pp. 464–466, provides only the most basic information. For technical information on the radio transmission problem caused by the plasma sheath and early thoughts about the potential for attenuating it, see Macon C. Ellis, Jr., and Paul W. Huber, “Real Gas Flow Conditions about Hypersonic Vehicles,” in *Reentry Dynamics, Part II: Proceedings of the Conference on Physics of the Solar System and Reentry Dynamics, July 31 to Aug. 11, 1961* (Blacksburg, Va.: Virginia Polytechnic Institute and State University, 1962), pp. 120–154; and John S. Evans and Paul W. Huber, “Calculated Radio Attenuation due to Plasma Sheath on Hypersonic Blunt-Nosed Cone,” NASA TN D-2043, Dec. 1963.
 35. Handwritten notes for briefing of the Langley senior staff, 15 Feb. 1962, in folder labeled “Text and Vu-graphs for 2/15/62 Briefing,” Ellis Collection, LHA.
 36. Quoted from “Langley Feasibility Study of Release of Barium Cloud within Earth’s Magnetosphere,” 16 Aug. 1965, p. 1, copy in folder labeled “Ba-Cloud Project,” Ellis Collection, LHA.
 37. For a summary of the scientific objectives of the barium cloud experiment, see “Scientific Merits of Experiment Involving a Barium Release at High Altitude (Several Earth Radii),” an unpublished Langley paper from early 1968, Ba-Cloud file, Ellis Collection, LHA.
 38. “Langley Feasibility Study of Release of Barium Cloud,” p. 2.
 39. L. Biermann, R. Lust, Rh. Lust, and H. U. Schmidt, “Zur Untersuchung des interplanetaren Mediums mit Hilfe künstliche eingebrachte Ionenwolken” [“Study of the Interplanetary Media by Means of Artificially Ionized Clouds”], in *Zeitschrift für Astrophysik* 53 (1961): 226–236. On Biermann’s important contributions to solar physics, see Hufbauer, *Exploring the Sun*, pp. 215–221.
 40. R. V. Hess, head, Plasma Physics Section, to Charles J. Donlan, Langley associate director, “Request for transmittal of letter to the Secretary of the Space Sciences Steering Committee concerning recent discussion of R. V. Hess with Prof. Biermann on use of plasma cloud as space probe,” 15 July 1964, Ba-Cloud file, Ellis Collection, LHA. On the front of this memorandum, MPD Branch Head Mike Ellis has penned the words, “Hess’[s] claim for plasma cloud idea!”
 41. NASA, “MPI/NASA Magnetospheric Ion Cloud Experiment Project Proposal/Development Plan,” 15 Dec. 1967, copy in Ba-Cloud file, Ellis Collection, LHA. Ellis audiotape, author’s transcript, pp. 3 and 19.
 42. For draft copies of the relevant memoranda of understanding between NASA and West Germany’s Federal Ministry for Scientific Research, see Ba-Cloud file, Ellis Collection, LHA.
 43. NASA, “MPI/NASA Magnetospheric Ion Cloud.”
 44. On the accident and the findings of the NASA investigative board, see the story in the *New York Times*, 9 July 1967. Max Planck Institut researchers also experienced an

Notes for Chapter 5

- accident involving the mishandling of barium; for an account see Linda Shiner, "Come to Aruba When the Barium Blooms," *Air & Space* 6 (Feb./Mar. 1992): 58.
45. Macon C. Ellis, Jr., letter to author, 28 Jan. 1991, p. 3. Ellis communicated Langley's "scooping" of the West Germans after talking to Leo D. Staton, one of the Langley men involved in NASA's analysis and reporting of the findings from the barium cloud experiments. For a summary of the results of the barium cloud experiments, see Hal T. Baber, Jr., Kenneth H. Crumbly, and David Adamson, *Barium Releases at Altitudes Between 200 and 1000 Kilometers—A Joint Max Planck Institut—NASA Experiment*, NASA SP-264 (Washington, 1971). For further analysis from NASA researchers, see David Adamson, Clifford L. Fricke, Sheila Ann T. Long, W. F. Landon, and D. L. Ridge, "Preliminary Analysis of NASA Optical Data Obtained in Barium Cloud Experiment of Sept. 21, 1971," in *Journal of Geophysical Research* 78 (1 Sept. 1973): 5769–5784; David Adamson and C. L. Fricke, "Barium Cloud Evolution and Striation Formation in the Magnetospheric Release on Sept. 21, 1971," NASA TN D-7722, Sept. 1974; and David Adamson, C. L. Fricke, and Sheila Ann T. Long, "Results of Magnetospheric Barium Ion Cloud Experiment of 1971," NASA TR R-437, Mar. 1975.
 46. Ellis to author, 28 Jan. 1991, p. 3.
 47. The best source for the history of Project Sherwood remains Amasa Bishop, *Project Sherwood: The U.S. Program in Controlled Fusion* (Reading, Mass.: Addison-Wesley Publishing Co., 1958). From 1953 to 1956, Dr. Bishop served as chief of research division in the Controlled Thermonuclear Branch of the Atomic Energy Commission. Several aspects of Project Sherwood are also covered in Joan Lisa Bromberg, *Fusion: Science, Politics, and the Invention of a New Energy Source* (Cambridge and London: MIT Press, 1983).
 48. Most of my insight into the nature of Langley's one-megajoule theta-pinch apparatus comes from the Ellis audiotape, author's transcript, p. 7. For a survey of the historical development of the various sorts of "pinch" devices, see chap. 3 (pp. 22–32) and chap. 10 (pp. 90–105), in Bishop, *Project Sherwood*. Also see Bromberg, *Fusion*, esp. pp. 6–7, 19–20, 25–26, 70–71, and 134–135; on the theta-pinch specifically, see pp. 143–144 and 226–227. For those interested in the technical details of Langley's one-megajoule energy storage system, a copy of the successful Nov. 1961 proposal for the system is preserved in the Ellis Collection, LHA.
 49. For a general summary of the intent of the Magnetic Compression Experiment, see the "Rough Text on Laboratory Astrophysics," prepared by Karlheinz Thom as the proposed text for an MPD presentation at the 1964 NASA Inspection, copy in Ellis Collection, LHA. Mike Ellis discusses this experiment on his audiotape, author's transcript, p. 15, and in his 28 Jan. 1991 letter to the author, p. 1.
 50. Langley's earliest published papers on the results of experiments in the plasma-focus facility include the following, all of which appeared in *The Bulletin of the American Physical Society*: J. H. Lee and C. E. Roos, "An Investigation of Hard X-rays from a Plasma Focus," 15 (1970): 642; J. H. Lee and L. P. Shomo, "Angular Variation of Neutron Yield from a Plasma Focus by Neutron-Induced Gamma Spectrometry," 15 (1970): 814; J. H. Lee and Nelson W. Jalufka, "Investigation of X-ray Emission from a Plasma Focus," 15 (1970): 815; J. H. Lee and L. P. Shomo, "Dependence of Neutron Fluence Anisotropy on the Neutron Yield of a Plasma Focus," 15 (1970): 1463; and Nelson W. Jalufka and

Notes for Chapter 6

J. H. Lee, "Investigation of Current Sheet Collapse in a Plasma Focus Apparatus," 15 (1970): 1462. For a complete list of publications and presented papers based on research in Langley's plasma-focus facility from 1968 to 1985, see the special bibliography on the plasma-focus facility that I have added to the Ellis Collection, LHA.

51. Macon C. Ellis, Jr., "15 Minute Briefing for Mr. Cortright," handwritten notes, June 1958, copy in folder labeled "Cortright June 24, 1968 Briefing," p. 4, Ellis Collection, LHA.
52. Ellis audiotape, author's transcript, p. 14.
53. Becker interview, 5 Aug. 1991.
54. Ellis audiotape, author's transcript, p. 17. For historical analysis of the slow and tortuous progress of fusion work through the doldrums in the 1960s, see Bromberg, *Fusion*, esp. pp. 110–174.
55. On the Nixon administration's rejection of the plan for a manned Mars mission in the 1970s and 1980s as the follow-on to the Apollo program and as the next great space challenge accepted by the United States, see Walter A. McDougall, *The Heavens and the Earth: A Political History of the Space Age* (New York: Basic Books, 1985), pp. 420–423; Michael Collins, *Liftoff: The Story of America's Adventure in Space* (New York: NASA/Grove Press, 1988), p. 201; and Edward C. Ezell and Linda Neuman Ezell, *On Mars: Exploration of the Red Planet, 1958–1978*, NASA SP-4212 (Washington, 1984), p. 186. Mike Ellis also comments on the ramifications of President Nixon's decision for the study of electric propulsion in his audiotape: "Nixon said that a manned Mars mission was a subject we could not talk about. 'It shall be relevant or it shall not be at all.' Electric propulsion was no longer relevant to any practical application; so, bingo, politically, we couldn't mention it," Ellis audiotape, author's transcript, p. 17.

If a manned mission to Mars is to be attempted in the twenty-first century, as many advocates of the American space program have strongly suggested, it will require a radically new nuclear or electric propulsion system like those studied by NASA's MPD experts in the 1960s. If that is the case, and the United States does endeavor to land astronauts on Mars sometime during the next century, the decision of the Nixon administration to stop basic research in that area will be seen as a significant temporary setback.

56. Robert V. Hess interview with author, 12 Nov. 1991; Ellis audiotape, author's transcript, p. 6.
57. Becker interview, 5 Aug. 1991.
58. Ellis to author, 28 Jan. 1991, p. 3.

Chapter 6

The Odyssey of Project Echo

1. Norman L. Crabill interview with author, Newport News, Va., 11 Nov. 1991, OHC, LHA.
2. Ibid.
3. Ibid.
4. Howard Gibbons, "Earthlings Stirred by NASA Balloon, Awesome Sight in the Sky," Newport News (Va.) *Daily Press*, 29 Oct. 1959.

Notes for Chapter 6

5. On the Upper Atmosphere Rocket Research Panel and its earlier incarnation as the V-2 Panel, see Homer Newell, *Beyond the Atmosphere: Early Years of Space Science*, NASA SP-4211 (Washington, 1980), pp. 33–49, and John E. Naugle, *First Among Equals: The Selection of NASA Space Science Experiments*, NASA SP-4215 (Washington, 1991), pp. 1–4. Both Newell and Naugle participated as research scientists in the history they examine in these books. A mathematician-turned-physicist, Newell worked with the V-2 missiles at White Sands, New Mexico, from 1947 to 1955, when he became the NRL's science program coordinator for Project Vanguard. Newell then joined NASA in 1958 and led its space science program through much of the 1960s. In 1960 physicist Naugle transferred from the Space Science Division at NASA Goddard, where he had been studying cosmic rays and protons in the magnetosphere using nuclear emulsions exposed during the flights of upper-atmosphere sounding rockets, to NASA headquarters where he supervised the space agency's research into fields and particles. On the history of the V-2, both in Germany and White Sands, see Walter Dornberger, *V-2—Shot into the Universe: The History of a Great Invention*, trans. James Cleugh, with intro. by Willy Ley (New York: Viking Press, 1958). Dornberger was the German army officer responsible for the V-2 program at Peenemünde. He came to work for the American rocket program after World War II as part of Operation Paperclip.
6. On the central role of Project Vanguard in the U.S. celebration of the IGY, see Constance Green and Milton Lomask, *Vanguard: A History* (Washington: Smithsonian Institution Press, 1971). For final edited versions of the presentations made at the Ann Arbor meeting, see James Van Allen, ed., *Scientific Uses of Earth Satellites* (Ann Arbor: University of Michigan Press, 1956). For a readable history of the IGY, see Walter Sullivan, *Assault on the Unknown: The International Geophysical Year*, 2d ed. (New York: McGraw-Hill, 1971).
7. C. E. Brown, W. J. O'Sullivan, Jr., and C. H. Zimmerman, "A Study of the Problems Relating to High Speed, High Altitude Flight," 25 June 1953, copy in the Langley Technical Library. For several years, this report was classified as "Secret." For more on the history of the Brown-Zimmerman-O'Sullivan study group, see James R. Hansen, *Engineer in Charge: The History of Langley Aeronautical Laboratory, 1917–1958*, NASA SP-4305 (Washington, 1987), pp. 351–353.
8. William J. O'Sullivan to Don Murray, Glen Ridge, N.J., 29 Sept. 1960, p. 3, copy in Milton Ames Collection, box 6, LHA. O'Sullivan wrote this letter to answer questions that Murray, a free-lance writer, had asked in preparation for a magazine article on O'Sullivan and the Echo balloon. The article was published as "O'Sullivan's Wonderful Lead Balloon" in the Feb. 1961 issue of *Popular Science Monthly*. Also, an interview with O'Sullivan about the genesis of inflatable satellites, conducted by Edward Morse and dated 28 Aug. 1964, is in a biography file concerning O'Sullivan in NASA HQA. Morse eventually drafted a "Preliminary History of the Origin of Project Syncom," NASA HNN-40, 1 Sept. 1964, copy in NASA HQA.
9. O'Sullivan to Murray, 29 Sept. 1960, pp. 3–4.
10. *Ibid.*, p. 4. See also O'Sullivan to Associate Director [Floyd L. Thompson], "Report on Project Vanguard and the IAS, UAARP, and TPR meetings of Jan. 25–27, 1956," 7 Feb. 1956, in Project Vanguard file, LCF.
11. O'Sullivan to Murray, 29 Sept. 1960, pp. 4–5.

12. Ibid., p. 6.
13. Ibid.
14. Ibid., pp. 6–7.
15. Ibid., p. 7.
16. For Arthur C. Clarke's thoughts on his 1945 article on "Extraterrestrial Relays" in *Wireless World*, see his *Profiles of the Future: An Inquiry Into the Limits of the Possible* (New York: Popular Library, 1977), pp. 205–207. *Profiles of the Future* first appeared in print in 1958.
17. Clarke, *Profiles of the Future*, pp. 205–207.
18. John R. Pierce, "Orbital Radio Relays," *Jet Propulsion* 25 (Apr. 1955): 153–157. For a later presentation by Pierce, see "Satellite Systems for Commercial Communications," a paper presented at the 28th Annual Meeting of the Institute of Aeronautical Sciences (IAS), New York City, 25–27 Jan. 1960, copy in Langley Technical Library. On Pierce's early ideas for communications satellites, see Delbert D. Smith, *Communications via Satellite: A Vision in Retrospect* (Boston: Little, Brown & Co., 1976), pp. 18–19.
19. For contemporary technical distinctions between active and passive satellites, see NASA, *Space Communications and Navigation, 1958–1964*, NASA SP-93 (Washington, 1966), pp. v and 1; see also Linda Neuman Ezell, *NASA Historical Data Book*, vol. 2, *Programs and Projects, 1958–1968*, NASA SP-4012 (Washington, 1988), p. 364. For insights into the nature of early U.S. satellite proposals, see R. Cargill Hall, "Early U.S. Satellite Proposals," *Technology and Culture* 4 (Fall 1963): 410–434.
20. O'Sullivan to Murray, 29 Sept. 1960, p. 7.
21. Ibid.
22. Ibid., pp. 7–8. On the IGY satellite program, see Newell, *Beyond the Atmosphere*, pp. 46–49.
23. See the introduction to James A. Van Allen, ed., *Scientific Uses of Earth Satellites* (Ann Arbor: University of Michigan Press, 1956); O'Sullivan to Murray, 29 Sept. 1960, p. 8.
24. O'Sullivan to Murray, 29 Sept. 1960, p. 8.
25. William J. O'Sullivan, Jr., to Director [Henry J. E. Reid], "Proposal for the NACA to undertake research on development of earth satellites," 29 June 1956; Robert R. Gilruth to Associate Director [Floyd L. Thompson], "Comments on suggestion for research on drag of earth satellite," 13 July 1956. Both letters are in the Project Vanguard file, LCF. A long section of O'Sullivan's 1956 proposal to NACA Langley for satellite research is quoted in Joseph A. Shortal, *A New Dimension: Wallops Flight Test Range, The First Fifteen Years*, NASA RP-1028 (Washington, 1978), p. 600. In the late 1950s and early 1960s during the genesis of inflatable spheres for space research, Shortal served as chief of PARC.
26. O'Sullivan to Murray, 29 Sept. 1960, pp. 8–9; O'Sullivan to Associate Director [Thompson], "Report on Action Taken by USNC/IGY Technical Panel on Earth Satellites on Sept. 5, 1956, regarding NACA Proposal," 19 Sept. 1956, in Project Vanguard file, LCF. See Newell, *Beyond the Atmosphere*, pp. 50–57 and app. E, "Original Membership of the U.S. National Committee for the International Geophysical Year," p. 433.
27. Joseph A. Shortal, memorandum for all concerned, 26 Dec. 1956, Project Vanguard file, LCF; Walter E. Bressette to author, 11 Mar. 1992, p. 2, author's files; Shortal, *A New Dimension*, p. 600.

Notes for Chapter 6

28. Murray, "O'Sullivan's Wonderful Lead Balloon," p. 47.
29. Ibid. Murray visited Langley while writing his story and witnessed the balloon-folding procedure.
30. Bressette to author, 11 Mar. 1992, p. 3.
31. "Sub-Satellite Originated at Langley Lab," *Air Scoop*, 5 Jan. 1957, p. 1. For details about the Sub-Satellite, see O'Sullivan, "The USNC/IGY-NACA Earth Sub-Satellite Experiment," a paper presented to the Comité Speciale de l'Année Géophysique Internationale (CSAGI) Rocket and Satellite Conference, Washington, D.C., 30 Sept.–5 Oct. 1957, copy in Langley Technical Library.
32. O'Sullivan to Murray, 29 Sept. 1960, p. 10. For a chronology of the "Highlights in the Inflatable Satellite Program," including a reference to the reconfirmation of an allotment of space for O'Sullivan's Sub-Satellite on Vanguard by the Technical Panel on the Earth Satellite Project, see "Recommendation for Distinguished Service Medal, Mr. William J. O'Sullivan, Jr., Aeronautical Research Engineer, Assistant to Division Chief, Applied Materials and Physics Division, and Head, Space Vehicles Group, AMPD, Langley Research Center," [ca. 1961], copy in Milton Ames Collection, box 6, LHA.
33. O'Sullivan to Murray, 29 Sept. 1960, pp. 9–10; Shortal, *A New Dimension*, pp. 600–604. For a chronology of the development and operations of Project Vanguard, see Ezell, *NASA Historical Data Book*, 2:87.
34. O'Sullivan to Murray, 29 Sept. 1960, p. 10. A copy of O'Sullivan's San Diego paper, "The USNC/IGY-NACA Earth Sub-Satellite Experiment," can be found in the Langley Technical Library. O'Sullivan presented an earlier version of this paper at a rocket and satellite conference held at the National Academy of Sciences in Washington the previous month.
35. Bressette to author, 11 Mar. 1992, p. 3; O'Sullivan to Associate Director [Thompson], "NACA 12-foot spherical satellite," 5 Dec. 1957, Project Vanguard file, LCF.
36. Walter A. McDougall, *The Heavens and the Earth: A Political History of the Space Age* (New York: Basic Books, 1985), p. 100.
37. "Moonwatchers," Newport News *Daily Press*, 6 Oct. 1957, front page.
38. Quoted in McDougall, *Heavens and the Earth*, p. 141. A transcript of an interview with Gerald Siegel about Sputnik and other issues related to politics and space is in NASA HQA.
39. Robert R. Gilruth, "Memoir: From Wallops Island to Mercury, 1945–1958," unpublished manuscript presented at the Sixth International History Symposium, Vienna, Austria, 13 Oct. 1972, pp. 33–34, copy in LHA; Charles J. Donlan interview with author, 17 Aug. 1990, transcript, p. 6, OHC, LHA.
40. O'Sullivan to Associate Director [Thompson], "Decisions made on NACA 12-foot satellite at Apr. 3, 1958 meeting of TPESP," 9 Apr. 1958, Project Vanguard file, LCF. See also O'Sullivan to Murray, 29 Sept. 1960, p. 10. For a summary description of the Jupiter C's development, see Wernher von Braun, Frederick I. Ordway III, and Dave Dooling, *Space Travel, A History: An Update of History of Rocketry and Space Travel*, 4th ed. (New York: Harper & Row, 1985), pp. 128–129.
41. At the same time O'Sullivan was directing the development of the NACA's 12-foot inflatable, he was also working on a pneumatically erectable satellite intended specifically for navigation purposes. Because a sphere would reflect radar signals in all directions,

O'Sullivan realized that this shape would not work as a navigation satellite. What was required instead was a "corner reflector" that would reflect signals back precisely from whence they came. With this basic knowledge of radar signals and optics in mind, O'Sullivan designed a little 6.4-inch-diameter passive reflector satellite equipped with tiny solar cells for flight into orbit aboard a Vanguard. Ground tests demonstrated, however, that an active satellite with a more powerful transmitter would make a much better navigation satellite, as it could be tracked by a comparatively small tracking receiver requiring little space and power and would not require a large and powerful radar. O'Sullivan, therefore, laid the corner reflector satellite aside in the spring of 1958 and concentrated on the Beacon satellite. See O'Sullivan to Murray, 29 Sept. 1960, pp. 10–11.

42. Shortal, *A New Dimension*, p. 607; Eugene M. Emme, *Aeronautics and Astronautics: An American Chronology of Science and Technology in the Exploration of Space, 1915–1960* (Washington: NASA, 1961), p. 110. Ezell, *NASA Historical Data Book* (2:370–371) provides a chronology of the development and operations of Project Echo, including information on the 30-inch Sub-Satellite and 12-foot inflatable sphere.
43. O'Sullivan to Associate Director [Thompson], "Launch vehicle for NACA 12-foot satellite," 11 July 1958, Project Vanguard file, LCF. See also Shortal, *A New Dimension*, p. 610; "Highlights in the Inflatable Satellite Program," in "Recommendation for Distinguished Service Medal, Mr. William J. O'Sullivan, Jr., [ca. 1961]," Ames Collection, box 6, LHA; Bressette to author, 11 Mar. 1992, p. 4. Bressette has pointed out that O'Sullivan's dogged insistence on a circular orbit for the inflatable satellites "nearly negated the Scout missions with the 12-foot sphere, because for the early Scout satellite launchings the Scout management required a 6-percent over-velocity at satellite insertion. This resulted in a very elliptical orbit." Scout was a low-budget, solid-propellant booster built by LTV of Dallas, Tex., which specialized in putting small payloads in orbit. As shall be explained in the next chapter of this book, NASA Langley served as project manager for Scout.

For details concerning the deployment and inflation techniques used for the 12-foot satellite, see Alan B. Kehlet and Herbert G. Patterson, "Free-Flight Test of a Technique for Inflating an NASA 12-Foot-Diameter Sphere at High Altitude," NASA Memo 2-5-59L, 1959, copy in the Langley Technical Library. Details about the design of the 30-inch and 12-foot inflatable spheres were presented in a special NASA report by Claude W. Coffee, Jr., Walter E. Bressette, and Gerald M. Keating, *Design of the NASA Lightweight Inflatable Satellites for the Determination of Atmospheric Density at Extreme Altitudes*, NASA TN D-1243, Apr. 1962.

44. O'Sullivan to Murray, 29 Sept. 1960, pp. 14–15; Shortal, *A New Dimension*, p. 610; von Braun, Ordway, and Dooling, *Space Travel*, pp. 156 and 172–173; Roger Bilstein, *Orders of Magnitude: A History of the NACA and NASA, 1915–1990*, NASA SP-4406 (Washington, 1980), p. 47.
45. O'Sullivan to Murray, 29 Sept. 1960, p. 15.
46. Walter E. Bressette, letter to author, 16 May 1992, author's files.
47. [Langley Aeronautical Laboratory], "Preliminary Langley Staff Study, NASA Space Flight Program," 15 May 1958, copy in folder "Space Material," Floyd L. Thompson Collection, LHA. On the early work by U.S. industry on communications satellites, see

Notes for Chapter 6

- Smith, *Communications via Satellite*, pp. 58–59; McDougall, *Heavens and the Earth*, p. 352.
48. O'Sullivan to Murray, 29 Sept. 1960, p. 11.
 49. Shortal, *A New Dimension*, p. 686; Bressette to author, 11 Mar. 1992, p. 4.
 50. Research Authorization (RA) A12L145, dated 8 May 1958, in Research Authorization Files, LHA. See also Shortal, *A New Dimension*, p. 686. For an outline of the early organization at Langley for Echo, see Jesse L. Mitchell to Associate Director [Thompson], "NACA 100-Foot Diameter Communications Satellite Experiment," copy in Project Echo file, LCF. See also Shortal, *A New Dimension*, pp. 686–687.
 51. William J. O'Sullivan to Associate Director [Floyd L. Thompson], "Meeting on establishment of a task group to carry work load on 30-inch, 12-foot, and 100-foot satellite, held on February 18, 1959," 19 Feb. 1959, Project Echo file, LCF. For NASA's public justification for Project Echo, see "NASA Urges Project Echo Participation," *Aviation Week*, 71 (14 Dec. 1959): 65–67.
 52. Leonard Jaffe, chief, Communications Satellite Program, "Project Echo: Results of Second Planning Meeting," 13 Oct. 1959, Project Echo file, LCF. The first Echo planning meeting had taken place on 10 June 1959; see Leonard Jaffe, "Results of Project Echo Planning Meeting on June 10, 1959," 16 June 1959, in Project Echo file. On JPL's part in the early stages of Project Echo, see Walter K. Victor and Robertson Stevens, "The Role of the Jet Propulsion Laboratory in Project Echo," JPL Tech. Release 34–141, 14 Oct. 1960; on the Goldstone receiving station, see Stevens and Victor, "The Goldstone Station Communications and Tracking System for Project Echo," JPL TR 32–59, 1 Dec. 1960. Copies of both are in the Langley Technical Library. On Bell Telephone's role, see William C. Jakes, Jr., Bell Labs, "Participation of Bell Telephone Laboratories in Project Echo and Experimental Results," NASA TN D-1127, Dec. 1961. The July 1961 issue of the *Bell System Technical Journal* is devoted to extensive discussion of Project Echo and Bell's participation in it.
 53. Robert J. Mackey, Jr., head, Communications Branch, NASA Goddard, "Echo A-12 Working Agreement: GSFC-LRC," 4 Jan. 1961, Project Echo file, LCF; Shortal, *A New Dimension*, p. 689. At the second Project Echo planning meeting on 13 Oct. 1959, Leonard Jaffe had named Goddard's Robert Mackey to be the "action officer" for Project Echo.
 54. On Project Shotput, see Shortal, *A New Dimension*, pp. 685–695. The author would like to thank Norman L. Crabill, one of the heads of the Shotput program at Langley, for sharing his personal papers relevant to Shotput, for example, his unpublished talk given at Langley on 24 May 1961 to the NASA/DOD Technical Committee on Communications Satellites, "The Echo A-12 Vertical Test Program." The complete documentary record of Shotput is preserved in the Project Shotput file, LCF.
 55. O'Sullivan to Murray, 29 Sept. 1960, pp. 12–13.
 56. *Ibid.*, pp. 13–14; Shortal, *A New Dimension*, pp. 690–691.
 57. O'Sullivan to Murray, 29 Sept. 1960, p. 14.
 58. Norman L. Crabill interview, 11 Nov. 1991.
 59. Bressette to author, 11 Mar. 1992, pp. 4–5. On 19 May 1961, the president of Schjeldahl, G. T. Schjeldahl, testified about his company's involvement with "Erectable and Inflatable Structures in Space" at a *Hearing before the Committee on Science and*

- Astronautics, U.S. House of Representatives, 87th Congress, First Session, May 19, 1961*, no. 12 (Washington: Government Printing Office, 1961), pp. 2–5. At this same hearing, Laurence K. Loftin, Jr., technical assistant to Langley Director Floyd Thompson, and William J. O’Sullivan, Jr., head of the Space Vehicle Group at Langley, also gave testimony concerning inflatable structures in space, including structures that could be used as space stations. Anyone interested in the manufacturing of the balloons should see G. T. Schjeldahl Co., “Design and Inflation of Inflatable and Rigidizable Passive Communication Satellites (Echo I and Echo II),” in *Aerospace Expandable Structures* (Mar. 1964): 576–604.
60. Crabill interview, 11 Nov. 1991; Shortal, *A New Dimension*, p. 690. By the early 1960s, Norman Crabill had become an expert on the ascent problems of sounding rockets and other launch vehicles; see his paper, “Ascent Problems of Sounding Rockets,” presented at an AGARD meeting on the Use of Rocket Vehicles in Flight Research, Scheveningen, the Netherlands, 18–21 July 1961, copy in Langley Technical Library.
 61. O’Sullivan to Associate Director [Thompson], “Results of Shotput test no. 1,” 16 Nov. 1959, in Project Echo file, LCF. For technical analysis of the launch problems involved with *Shotput 1*, see Robert L. James, Jr., and Ronald J. Harris, *Calculation of Wind Compensation for Launching of Unguided Rockets*, NASA TN D-645, Apr. 1961; Robert L. James, Jr., *A Three-Dimensional Trajectory Simulation Using Six Degrees of Freedom with Arbitrary Wind*, NASA TN D-641, Mar. 1961; and Sherman A. Clevenson, memorandum for files, “Spin-balancing and alignment of the second stage of the first SHOT PUT at Wallops Island, Virginia,” 4 Nov. 1959, Project Shotput file, LCF. See also Norman L. Crabill, *Ascent Problems of Sounding Rockets*, AGARD Report 391, July 1961.
 62. O’Sullivan to Murray, 29 Sept. 1960, p. 12.
 63. *Ibid.*; Shortal, *A New Dimension*, p. 691.
 64. O’Sullivan to Murray, 29 Sept. 1960, p. 13; O’Sullivan to Associate Director [Thompson], “Echo satellite collapsing and inflation pressures,” 19 Jan. 1960, Project Echo file, LCF.
 65. For details about the launch-vehicle problem in *Shotput 2*, see Norman L. Crabill to Clarence L. Gillis, “Preliminary data and analysis for the SHOTPUT No. 2 vehicle, fired Jan. 16, 1960, at 5:30:00.108 p.m. EST,” 29 Jan. 1960. On the balloon tear in *Shotput 3*, see C. D. Bailey, memorandum for files, “Shotput 3,” 29 Feb. 1960, as well as “NASA Trajectory Data for Shot Put 3, Flown Feb. 27, 1960, at 6:20:54.3 p.m. EST,” 9 May 1960. These documents are in the Project Shotput file, LCF.
 66. Crabill interview, 11 Nov. 1991; Shortal, *A New Dimension*, pp. 690–692. For general information and the public reaction to *Shotputs 2* and *3*, see “Wallops Launches Inflatable Satellite, Visible from Afar,” *Newport News Daily Press*, 17 Jan. 1960; “Recorded Message Bounced Off NASA’s Space Sphere,” *Daily Press*, 28 Feb. 1960. Many technical documents relating to the trajectory and tracking of the Shotputs are in the Project Shotput file, LCF.
 67. Edwin P. Kilgore to author, 17 Feb. 1992, author’s files.
 68. *Ibid.*; Shortal, *A New Dimension*, p. 693.
 69. Crabill interview, 11 Nov. 1991.
 70. Crabill interview, 11 Nov. 1991; Shortal, *A New Dimension*, pp. 689–690. Bressette and Coffee conducted an analysis in the spring of 1959 to determine the gas leakage to be expected from meteoroid puncture, concluding that the balloon should retain sufficient

Notes for Chapter 6

- pressure to remain spherical for at least seven days. For their optimistic findings, see their memorandum for Space Vehicle Branch files, "Gas leakage from the 100-foot sphere caused by meteoroid puncture," 22 May 1959, in Project Echo file, LCF.
71. President Eisenhower's message is quoted in full in "Highlights in the Inflatable Satellite Program," p. 4, box 5, Milton Ames Collection, LHA.
 72. For these articles, see the front pages of the Newport News *Daily Press*, 12–16 Aug. 1960. On 14 Aug., the Chesapeake and Potomac Telephone Company of Virginia ran a full-page ad in the *Daily Press* in celebration of Echo and the "First Phone Call Via a Man-Made Satellite."
 73. Crabill interview, 11 Nov. 1991. For a complete technical overview of the *Echo 1* mission from the point of view of the launch-vehicle contractor, see Douglas Aircraft Co., Inc., "Detailed Test Objectives for Launch Vehicle Mission No. 1—Echo 1 Payload Delta Program," Feb. 1960, copy in Langley Technical Library.
 74. Leonard Jaffe, "Project Echo Results," *Astronautics* 6 (May 1961): 32–33, 80. See also Shortal, *A New Dimension*, pp. 694–695, and Alfred Rosenthal, *Venture into Space*, NASA SP-4301 (Washington, 1968), p. 89.
 75. See George R. Thompson, "NASA's Role in the Development of Commercial Satellite Communications," NASA HHM-8, 31 Jan. 1966; Bilstein, *Orders of Magnitude*, pp. 56–57 and 65–65. For basic information about the NASA satellite communications programs of the 1960s, see Ezell, *NASA Historical Data Book*, 2:364–394. For the contemporary thinking on satellite programs, see "The NASA Communications Satellite Program," 9 Feb. 1961, copy in Langley Technical Library, code N-96842; this report reviews NASA objectives in passive and active communications satellite programs as of early 1961. See also Leonard Jaffe, "NASA Communications Satellite Program," in *Proceedings of the Second National Conference on the Peaceful Uses of Space, Seattle, May 8–10, 1962* (Nov. 1962): 103–114, copy in Langley Technical Library.
 76. Bressette to author, 16 May 1992.
 77. See Bressette, *Study of a Passive Communication, Gravity-Gradient Stabilized, Lenticular Satellite*, Jan. 1965, copy in Langley Technical Library, GER 11893. For Langley's commitment to passive reflectors in the early 1960s, see Warren Gillespie, "An Earth-Oriented Communication Satellite of the Passive Type," in *Advances in Astronautical Sciences* 6 (1961): 51–63.
 78. Newell, *Beyond the Atmosphere*, pp. 144–153. For information on the Explorer missions, see also Ezell, *NASA Historical Data Book*, 2:232–253; Helen T. Wells, Susan H. Whitely, and Carrie E. Karegeannes, "Explorer," in *Origins of NASA Names*, NASA SP-4402 (Washington, 1976), pp. 49–52. For technical details of the *Explorer 9* mission, see O'Sullivan, Claude W. Coffee, Jr., and Gerald M. Keating, "Air Density Measurements from the Explorer 9 Satellite," paper presented at a Meeting of the International Committee on Space Research, Washington, D.C., 30 Apr.–11 May 1962, copy in Langley Technical Library.
 79. Ezell, *NASA Historical Data Book*, 2:298, 400. See also Coffee, Bressette, and Keating, *Design of the NASA Lightweight Inflatable Satellites*, NASA TN D-1243, Apr. 1962.
 80. Von Braun, Ordway, and Dooling, *Space Travel*, pp. 174–175.
 81. In keeping with a historic and unique national pattern of competitive private ownership of the means of communications, it was NASA's job to help private enterprise set up

an effective commercial comsat system through its state-funded R&D, not to create the entire system itself. A rather flexible policy directive from the Eisenhower administration supporting the early establishment of a commercial comsat system led to NASA's joint project with AT&T for Telstar but still left room for NASA's own development of Relay. In May 1961, however, the political framework for NASA's participation in the comsat business changed dramatically with President Kennedy's announcement of his ambitious plan for a single global comsat system. This announcement was made in his lunar landing speech. For analysis of these developments involving NASA and commercial comsats, see McDougall, *Heavens and the Earth*, pp. 352–359.

82. Von Braun, Ordway, and Dooling, *Space Travel*, p. 174.
83. Bilstein, *Orders of Magnitude*, pp. 65–66.
84. Arthur C. Clarke, "A Short Pre-History of Comsats, Or: How I Lost a Billion Dollars in My Spare Time," in *Voices from the Sky: Previews of the Coming Space Age* (New York, 1965), pp. 119–128.
85. Crabill interview, 11 Nov. 1991.

Chapter 7

Learning Through Failure: The Early Rush of the Scout Rocket Program

1. Abraham Leiss interview with author, Hampton, Va., 19 July 1990; see also Roland D. English interview with David Ferraro, Hampton, Va., 14 Dec. 1990. Transcripts of all Ferraro's interviews, which were conducted in preparation for a 1991 NASA video on the history of Scout, are located in the OHC, LHA. The author wishes to thank Mr. Ferraro, a talented producer of video documentaries, for generously sharing his many interviews concerning Scout. The essential documents regarding the history of Scout can be found in the Scout Project files, LHA, which are organized chronologically.

Fortunately, personnel in the Scout Project Office (notably Abraham Leiss), because of their understandable pride in the many accomplishments of the Scout rocket, kept detailed scrapbooks with clippings, documents, photos, and other miscellaneous materials central to the history of Scout. This chapter offers only a brief look into that history during its troubled early period. A comprehensive scholarly history of the Scout program has not yet been written.

2. For a detailed history of PARD's work at Wallops Island, see Joseph A. Shortal, *A New Dimension: Wallops Island Flight Test Range, the First Fifteen Years*, NASA RP-1028 (Washington, Dec. 1978). Shortal was the second head of PARD operations (and subsequently of the Applied Materials and Physics Division) at Wallops Island from 1951 to his retirement in the late 1960s. His history is especially valuable as an insider's account of what went on at Wallops Island just before and after the start of the spaceflight revolution.
3. On Vanguard, nothing has yet surpassed Constance M. Green and Milton Lomask, *Vanguard: A History*, NASA SP-4202 (Washington, 1970); on the IGY, see Sydney Chapman, *IGY: Year of Discovery* (Ann Arbor: University of Michigan Press, 1959); Walter Sullivan, *Assault on the Unknown: The IGY Discovery* (New York: McGraw-Hill, 1961); and J. Tuzo Wilson, *IGY: The Year of the New Moons* (New York: Knopf,

Notes for Chapter 7

- 1961). For a concise and insightful analysis of the IGY history, see Walter A. McDougall, *The Heavens and the Earth: A Political History of the Space Age* (New York: Basic Books, 1985), pp. 112–140.
4. English interview with Ferraro, 14 Dec. 1990; James R. Hall interview with Ferraro, Hampton, Va., 4 Dec. 1990.
 5. Shortal, *A New Dimension*, pp. 706–707.
 6. Ibid.
 7. Remarks made by William E. Stoney to Ferraro and used in the 1991 NASA video, “Scout: The Unsung Hero of Space.”
 8. Shortal, *A New Dimension*, p. 707.
 9. *NASA Space Flight Program*, Preliminary Langley Staff Study, 15 May 1958, pp. 1 and 28, Scout Project files, LHA.
 10. This research authorization (RA) is not in the RA files in the LHA, which for some unknown reason only encompass the early 1950s. For a discussion of this RA, see Shortal, *A New Dimension*, p. 707.
 11. This air force effort to develop an advanced solid-fuel rocket launch vehicle was known to the DOD as “Project 609A” (Hyper-Environmental Test System 609A). For details of the agreement between the air force and the NACA (and later NASA), see Clotaire Wood to Langley Director [Reid], 11 July 1958, in the Scout Project files, LHA. Enclosed in this letter is a document entitled “Specifications for Solid-Fuel Rocket Test Vehicle,” dated a day earlier. See also “Aeroneutronic Wins New Space Contract, AF Project Involves High-Altitude Tests,” *Aeroneutronic News*, Newport Beach, Calif., 9 May 1960. For an example of Scout’s early role in the air force’s nuclear weapons testing program, see the 10 Oct. 1960 issue of *Aviation Week and Space Technology*; its lengthy cover story concerns the air force’s first launch of a “Blue Scout” rocket. See also “Nuclear Detector Sent Up, Blue Scout’s 1st Flight,” Norfolk-Portsmouth (Va.) *Virginian-Pilot*, 22 Sept. 1960.
 12. Shortal, *A New Dimension*, p. 707.
 13. Ibid., p. 708; see also Ferraro letter to author, 9 Sept. 1991, copy in LHA.
 14. Warren J. North, chief, Manned Satellite Program, to NASA Administrator (T. Keith Glennan), “Status Report No. 1—Scout,” 3 Mar. 1959, copy in Scout Project files, LHA. See also “NASA Awards Scout Contracts,” *Aviation Week*, 2 Mar. 1959, p. 2; and “First Scout Vehicle Delivery Due Aug. 15,” *Aviation Week*, 16 Mar. 1959, p. 26. For a concise and well-illustrated introduction to the details of the Scout rocket, see LTV publication, *The Scout: Solid Propellant Launch Vehicles* (Dallas, 1962), copy in the Floyd L. Thompson Collection, LHA, folder labeled “Scout.” See also Shortal, *A New Dimension*, pp. 708–710.
- For an excellent technical summary of the evolution of the Scout program to 1968 by someone intimately involved with it, see Milt Green, “Project Review—Scout Launch Vehicle,” in *Spacecraft Systems Education*, 2 vols. (Belgrade, [formerly] Yugoslavia: Pergamon Press, 1968), 2:3–15. Green was the program director for the Scout Missiles and Space Division of LTV in Dallas.
15. On the X-1 (or more technically, XS-1) program at Langley, see chap. 10 of James R. Hansen, *Engineer in Charge: A History of the Langley Aeronautical Laboratory*,

Notes for Chapter 7

- 1917–1958, NASA SP-4305 (Washington, 1987), pp. 271–310; for more general histories of the X-1 flight test program, see Richard P. Hallion, *Supersonic Flight: The Story of the Bell X-1 and Douglas D-558* (New York & London: Macmillan Co., 1972) and *On the Frontier: Flight Research at Dryden, 1946–1981*, NASA SP-4303 (Washington, 1984), esp. chap. 1, pp. 3–22.
16. James R. Hall quoted in “Scout Moves to Goddard: Leaves Legacy of Camaraderie,” *Langley Researcher News*, 25 Jan. 1991, p. 7.
 17. H. J. E. Reid, memorandum for all concerned, “Establishment of Scout Project Group,” 29 Feb. 1960, in Scout Project files, LHA. On Scout’s organization, see also Eugene C. Draley, memorandum for files, “Scout Organization,” 4 Mar. 1960, Scout Project files, LHA. This group was already located on the second floor of the impact basin building on Langley’s west side. The individuals assigned to Scout from the various Langley research divisions were: Carl A. Sandahl and Andrew G. Swanson from the Applied Materials and Physics Division; William J. Nelson from the Aero-Physics Division; Max C. Kurbjun from the Aero-Space Mechanics Division; Harry L. Runyan, Jr., from the Dynamic Loads Division; Axel T. Mattson from the Full-Scale Research Division; James E. Stitt from IRD; Leonard Sternfeld from the Theoretical Mechanics Division; Isidore G. Recant from the Unitary Plan Wind Tunnel Division; and Edwin C. Kilgore from the Engineering Service Division. One individual each was also assigned from the Mechanical Service Division, the Electrical Service Division, the Procurement Division, as well as from Maintenance. The project office gave regular written status reports to Langley management, copies of which are preserved in the Scout Project files, LHA.
 18. Hall interview with Ferraro, 4 Dec. 1990. In 1959 two Langley researchers in the Theoretical Mechanics Division, Robert H. Tolson and Wilbur C. Mayo, conducted “Studies of Use of the Scout as a Booster Vehicle for Lunar Exploration.” For more about the lunar exploration studies based in this Langley research division, see the next chapter.
 19. Leiss interview, 19 July 1990.
 20. Hall quoted in “Scout Moves to Goddard,” *Langley Researcher News*, 25 Jan. 1991, p. 7. For basic information on the Scout Project in its very early period, see the unofficial “Scout Manual,” prepared by the Scout Project Office at Langley on 25 Apr. 1960 and distributed to all Langley Scout team members. The cover of this manual shows a triangle-faced Boy Scout saluting in front of a Scout rocket. A copy of this manual and all subsequent Scout manuals are in the notebook “Scout Project, 1959–1961,” LHA. Such notebooks, unofficial scrapbooks, were kept by the Scout Project Office for the entire period of Scout’s operation.
 21. Shortal, *A New Dimension*, pp. 709–710.
 22. Hall interview with Ferraro, 4 Dec. 1990; Ken Jacobs interview with Ferraro, Hampton, Va., 29 Nov. 1990; Milt Green interview with Ferraro, Hampton, Va., 28 Nov. 1990.
 23. Larry Tant interview with Ferraro, Hampton, Va., 14 Dec. 1990; Jon Van Cleve interview with Ferraro, Hampton, Va., 16 Nov. 1990.
 24. William E. Stoney, Jr., and Edwin C. Kilgore, memorandum for the Langley Associate Director (Floyd L. Thompson), “Outline of steps required to insure an earliest possible firing of the Scout and those required to make possible subsequent firings at intervals of not over two months,” 28 Jan. 1960; H. J. E. Reid, Langley director, to NASA,

Notes for Chapter 7

- Code R (Research), "Acceleration of Scout Program to insure earliest possible firing and to make possible subsequent firings at intervals of not over 2 months," 29 Jan. 1960. Both documents are in the Scout Project files, LHA. See also Shortal, *A New Dimension*, p. 717.
25. Hall quoted in "Scout Moves to Goddard," p. 7.
 26. Shortal, *A New Dimension*, pp. 717–718.
 27. *Ibid.*, p. 718; "NASA Launches 'Scout' Vehicle in Wallops Test," Newport News (Va.) *Daily Press*, 19 Apr. 1960; "Ignition Failure in Third Stage Aborts Initial Scout Test Launch," *Daily Press*, 25 Apr. 1960.
 28. Hall quoted in "Scout Moves to Goddard," p. 7.
 29. *Ibid.*
 30. *Ibid.*; "Scout Veers, Is Destroyed After Firing From Wallops," *Baltimore Sun*, 2 July 1960. See also Robert J. Mayhue, *Scout ST-1 Flight-Test Results and Analyses, Launch Operations, and Test Vehicle Description*, NASA TN-1240 (Washington, June 1962), and Shortal, *A New Dimension*, p. 720.
 31. Hall quoted in "Scout Moves to Goddard," p. 7. For details of the launch, see "Preliminary Flight Report on Scout ST-1," Dec. 1960, Scout Project files, LHA.
 32. "Obtain Valuable Data in First Scout Launching," NASA Langley *Air Scoop*, 8 July 1960; "NASA Fires Scout," Newport News (Va.) *Times Herald*, 2 July 1960. Copies of the press releases given out by NASA after the launch are preserved in the "Scout Project, 1959–1961" notebook, LHA. Also see Shortal, *A New Dimension*, p. 720.
 33. "Preliminary Flight Test Results of Scout ST-2," Dec. 1960, Scout Project files, LHA. On the military launches, see "USAF Launches Second Blue Scout," *Aviation Week*, 21 Nov. 1960, p. 30. Copies of all newspaper articles mentioned in the text can be found in the notebook, "Scout Project, 1959–1961," LHA.
 34. Vought Corp. brochure, "100 Scout Launches, 1960–1979," published for program in celebration of 100th Scout, held in Williamsburg, Va., 27 July 1979.
 35. English interview with Ferraro, 14 Dec. 1990.
 36. Hall quoted in "Scout Moves to Goddard," p. 7.
 37. "Scout Shot Veers Off, Destroyed," Newport News *Daily Press*, 21 July 1963; English interview with Ferraro, 14 Dec. 1990. For details, see LTV, "NASA Scout S-110, Final Flight Report," 7 Aug. 1963, report code 3-30000/3R-233, copy in Scout Project files, LHA.
 38. Tom Perry interview with Ferraro, Hampton, Va., 14 Dec. 1990.
 39. Eventually two Scout review committees were formed. The first, created on 22 July 1963, was chaired by Richard R. Heldenfels, the hard-nosed director of the Structures Research Division at Langley. The other six members of this review committee were Langley engineers Edward M. Gregory, Edwin C. Kilgore, Clifford H. Nelson, Eugene D. Schult, Joseph A. Shortal, and Joseph G. Thibodaux, Jr. This committee was to look specifically into the most recent Scout 110 failure. The second committee, an intercenter group chaired by Richard B. Morrison of NASA headquarters, was to look more generally into the problems of the Scout program. The other members of this panel included Eugene C. Draley of Langley; Hermann W. Kroeger of Marshall Space Flight Center; Daniel G. Mazur of Goddard Space Flight Center; and William A. Fleming, Milton W. Rosen, and Warren A. Guild, all of NASA headquarters. For details on the second committee, see

- Homer E. Newell, director, Office of Space Sciences, NASA headquarters, to director, Langley Research Center, "Scout Review Committee," 9 Oct. 1963, in Scout Project files, LHA. All the documents collected by the Langley committee, all the minutes of meetings, plus the final reports and recommendations of both committees can be found in the Scout Project files, LHA.
40. Hall interview with Ferraro, 4 Dec. 1990.
 41. Eugene D. Schult interview with Ferraro, Hampton, Va., 6 Dec. 1990.
 42. Jacobs interview with Ferraro, 29 Nov. 1990; English interview with Ferraro, 14 Dec. 1990.
 43. Jacobs interview with Ferraro, 29 Nov. 1990. The ups and downs of the Scout program can best be followed by surveying the "Scout Vehicle Status Reports." These reports were reviewed after every one or two flights. Copies of all these reports are in the Scout Project files, LHA.
 44. Hall interview with Ferraro, 4 Dec. 1990.
 45. See Langley Research Center, *Project Development Plan: Scout Program*, Jan. 1964. This 100-page document expresses the essentials of the recertification process. Other documents from the recertification process include "Scout Engineering Program Plan," revised 4 Mar. 1964, and "NASA/DOD Scout Launch Complex Maintenance Manual," 2 vols., 15 Feb. 1964. All these documents are in the Scout Project files, LHA.
 46. Green interview with Ferraro, 28 Nov. 1990.
 47. Schult interview with Ferraro, 6 Dec. 1990.
 48. English interview with Ferraro, 14 Dec. 1990.
 49. LTV Missiles and Electronics Group brochure, "Scout: 30 Years of Service, 1960–1990," (Dallas, Feb. 1991). For more basic historical information on Scout, see Linda Neuman Ezell, *NASA Historical Data Book*, vol. 2, *Programs and Project 1958–1968*, NASA SP-4012 (Washington, 1988), pp. 19–21, 61–67, 244–247, 444–448, and 465–477. For a comprehensive listing of the technical reports published by NASA and its contractors relevant to Scout, see Abraham Leiss, *Scout Launch Vehicle Program, Final Report*, 3 vols. (NASA Langley: NASA CR-165950, May 1982), 3:1122–1206.
 50. The preceding summary of Scout's accomplishments has been composed largely from a survey of the newspaper clippings, magazine stories, documents, and miscellaneous materials in the Scout Project Office scrapbooks. For more exhaustive details on the Scout launch vehicle program, including the San Marco operation, see Abraham Leiss, *Scout Launch Vehicle Program*. Mr. Leiss, as the chief administrative assistant of the Scout Project Office from its inception in 1960, has collected in these three volumes everything any researcher could possibly want to know about Scout. For an excellent short history of the Scout program to 1979, see Andrew Wilson, "Scout: NASA's Small Satellite Launcher," *Spaceflight* 21 (Nov. 1979): 446–459.
 51. See "Scout Financial Data" in Leiss, *Scout Launch Vehicle Program*, 1:268–270.
 52. Perry interview with Ferraro, 14 Dec. 1990. David Ferraro used Perry's phrase "the unsung hero of space" as the subtitle for his 1991 NASA video on Scout.
 53. Van Cleve interview with Ferraro, 16 Nov. 1990.
 54. Hall quoted in "Scout Moves to Goddard," p. 7.

Chapter 8

Enchanted Rendezvous: The Lunar-Orbit Rendezvous Concept

1. President John F. Kennedy, quoted in John M. Logsdon, *The Decision to Go to the Moon: Project Apollo and the National Interest* (Chicago: University of Chicago Press, 1976), p. 128.
2. Robert R. Gilruth, "Experts Were Stunned by Scope of Mission," *New York Times*, Moon Special Supplement, 17 July 1969. The description of Gilruth's reaction is from my interview with him in Kilmarnock, Va., 10 July 1986, and from Charles Murray and Catherine Bly Cox, *Apollo: The Race to the Moon* (New York: Touchstone Books, 1989), pp. 16–17.
3. Robert R. Gilruth to Francis W. Kemmett, director of the staff, Inventions and Contributions Board, NASA headquarters, 28 Aug. 1973. The main purpose of Gilruth's letter, solicited by a NASA awards board, was to evaluate Dr. John C. Houbolt's role in NASA's July 1962 decision in favor of LOR for Project Apollo and to determine whether Houbolt's contribution was worthy of the maximum prize that NASA had been authorized to give (\$100,000) for an outstanding national contribution. To do that, however, Gilruth had to review the STG's position on LOR and the entire Apollo mission-mode controversy. I do not believe any historian besides myself has seen this letter, a copy of which is in my personal LOR file.
4. Clinton E. Brown interview with the author, Hampton, Va., 17 July 1989. Brown's remarks are from a panel discussion (involving Brown, William H. Michael, Jr., and Arthur W. Vogeley), which I organized and led as part of NASA Langley's celebration of the 20th anniversary of Apollo 11, the first manned lunar landing. A videotape of the evening program featuring this panel discussion is preserved in the LHA.
5. Interview with William H. Michael, Jr., Hampton, Va., 17 July 1989, videotape, LHA. F. R. Moulton's book on celestial mechanics was available by 1958 in a second edition (London: Macmillan Co., 1956), but the Langley Technical Library appears not to have had it. The library has obtained one since.
6. On the history of pioneering thought about and proposals for space stations, see Frederick I. Ordway III, "The History, Evolution, and Benefits of the Space Station Concept," presented to the 13th International Congress of History of Science, Aug. 1971; and Barton C. Hacker, "And Rest as on a Natural Station: From Space Station to Orbital Operations in Space-Travel Thought, 1885–1951." Both of the preceding unpublished papers are available in the HQA. For published information, see Wernher von Braun and Frederick I. Ordway III, *Space Travel: A History: An Update of 'History of Rocketry & Space Travel'* (New York: Harper & Row, 1985), pp. 18–20; and Howard E. McCurdy, *The Space Station Decision: Incremental Politics and Technological Choice* (Baltimore and London: Johns Hopkins University Press, 1991), pp. 5–8 and 237 n. 7. On NASA's belief that a space station was the logical follow-on to Project Mercury, see Barton C. Hacker and James M. Grimwood, *On the Shoulders of Titans: A History of Project Gemini*, NASA SP-4203 (Washington, 1977), pp. 5–6; and McCurdy, *Space Station Decision*, pp. 7–9.
7. Brown interview, 17 July 1989.

8. Clinton E. Brown to Eugene C. Draley, "Formation of a working group to study the problems of Lunar exploration," 24 Mar. 1959, A200-1B, LCF.
9. William H. Michael, Jr., to Eugene C. Draley, "Attendance at meeting of Working Group on Lunar and Planetary Surfaces Exploration at NASA Headquarters on February 14, 1959," A200-1B, LCF; Michael, "Attendance at meeting for Discussion of Advanced Phases of Lunar Exploration at NASA Offices, Silver Spring, Md., Saturday, May 2, 1959," A200-1B, LCF. On the Jastrow Committee, see R. Cargill Hall, *Lunar Impact: A History of Project Ranger*, NASA SP-4210 (Washington, 1977), pp. 15–16; and William David Compton, *Where No Man Has Gone Before: A History of Apollo Lunar Exploration Missions*, NASA SP-4214 (Washington, 1989), pp. 13–14.
10. Harry J. Goett to Ira H. Abbott, "Interim Report on Operation of Research Steering Committee on Manned Space Flight," 17 July 1959, A200-1B, LCF. On the Goett Committee, see Hacker and Grimwood, *On the Shoulders of Titans*, pp. 9–10; Logsdon, *Decision to Go to the Moon*, pp. 56–57; and Murray and Cox, *Apollo*, pp. 43–45.
11. Laurence K. Loftin, Jr., interview with author, Newport News, Va., 5 Aug. 1989, transcript, p. 100, OHC, LHA; Murray and Cox, *Apollo*, pp. 43–45.
12. Michael interview, 17 July 1989.
13. W. H. Michael, Jr., "Weight Advantages of Use of Parking Orbit for Lunar Soft Landing Mission," in Lunar Trajectory Group's [Theoretical Mechanics Division] unpublished "Studies Related to Lunar and Planetary Missions," 26 May 1960, A200-1B, LCF.
14. On 13 Nov. 1948, H. E. Ross presented the essential elements of LOR to a meeting of the British Interplanetary Society in London. His conclusion was that LOR—compared with a direct flight to the lunar surface from the earth—would reduce the earth-launch weight by a factor of 2.6. In his paper Ross credited Hermann Oberth, Guido von Pirquet, Hermann Noordung, Walter Hohmann (of "Hohmann transfer" fame), Tsiolkovskii, and F. A. Tsander for their early ideas concerning LOR. See H. E. Ross, "Orbital Bases," in *Journal of the British Interplanetary Society* 26 (Jan. 1949): 1–18. For the history of the first pioneering inklings about the value of rendezvous in orbit, lunar and otherwise, see Barton C. Hacker, "The Idea of Rendezvous: From Space Station to Orbital Operations in Space-Travel Thought, 1895–1951," *Technology and Culture* 15 (July 1974): 373–388; as well as Hacker and Grimwood, *On the Shoulders of Titans*, pp. 5–6.
15. For the Vought concept that came out of the MALLAR study, see Vought Astronautics brochure, *Manned, Modular, Multi-Purpose Space Vehicle*, Jan. 1960.
16. The quote from Clint Brown about Michael's reaction to the Vought briefing is from Murray and Cox, *Apollo*, pp. 114–115.
17. Michael interview with author, Hampton, Va., 7 Apr. 1989, transcript, p. 6, OHC, LHA. The story about Tom Dolan discussing the essentials of LOR with unknown engineers in PARD is taken from John D. Bird, "A Short History of the Development of the Lunar-Orbit-Rendezvous Plan at the Langley Research Center," 6 Sept. 1963 (supplemented 5 Feb. 1965 and 17 Feb. 1966), box 6, Milton Ames Collection, LHA.
18. Michael, "Weight Advantages of Use of Parking Orbit for Lunar Soft Landing Mission," p. 2.
19. The "Jaybird" story is taken from Murray and Cox, *Apollo*, p. 115. For the technical reports that resulted from the early lunar studies in the Theoretical Mechanics Division, see among others: J. P. Gapcynski, "A Consideration of Some of the Factors Involved in

Notes for Chapter 8

- the Departure of a Vehicle from a Circular Orbit About the Earth"; and W. L. Mayo, "Energy and Mass Requirements for Lunar and Martian Missions." Both articles are in the Lunar Trajectory Group's "Studies Related to Lunar and Planetary Missions." On Bird's lunar bug ideas, see Michael interview, 7 Apr. 1989, pp. 14–15. See also William H. Michael, Jr., and Robert H. Tolson, "Effect of Eccentricity of the Lunar Orbit, Oblateness of the Earth, and Solar Gravitational Field on Lunar Trajectories," June 1960, copy in the Langley Technical Library.
20. John C. Houbolt, "A Study of Several Aerothermoelastic Problems of Aircraft Structures in High-Speed Flight," in *Eidgenössische Technische Hochschule Mitteilung* 5 (1958): 108. Throughout his career at NASA and NASA Langley, Houbolt was not a terribly prolific author. A complete bibliography of his papers is available in the LHA.
 21. John C. Houbolt interview with author, Williamsburg, Va., 24 Aug. 1989, transcript, p. 3, OHC, LHA.
 22. *Ibid.*, pp. 7–8.
 23. *Ibid.*, p. 9. On Rand and the early space program, see Walter A. McDougall, *The Heavens and the Earth: A Political History of the Space Age* (New York: Basic Books, 1985), esp. pp. 89, 102, 106–110, and 121–123.
 24. Hacker and Grimwood, *On the Shoulders of Titans*, p. 13; Loftin interview, 5 Aug. 1989, pp. 100–101.
 25. NASA Langley, "Minutes of Meeting of LRC Manned Space Laboratory Group," 18 Sept. 1959, A200-4, LCF. See paragraph 5 for Houbolt's statement on the rendezvous problem.
 26. Houbolt interview, 24 Aug. 1989, pp. 9–10.
 27. Bernard Maggin to Milton B. Ames, Jr., "Inter-center discussions of space rendezvous," 23 May 1960; John C. Houbolt, "Considerations of the Rendezvous Problems for Space Vehicles," presented at the National Aeronautical Meeting of the Society of Automotive Engineers, New York City, 5–8 Apr. 1960. Both documents are in A200-1A, LCF. The point about Marshall's limited interest in the rendezvous problem is made in Hacker and Grimwood, *On the Shoulders of Titans*, pp. 14–15.
 28. Lowell E. Hasel, "Minutes of Meeting of LRC Lunar Mission Steering Group," 24 May 1960, A200-1B, LCF.
 29. STG, "Guidelines for Advanced Manned Space Vehicle Program," June 1960. For the summary details of these guidelines, see Ivan D. Ertel and Mary Louise Morse, *The Apollo Spacecraft: A Chronology* (Washington: NASA, 1969), 1:38-41. In brief, the STG identified a manned circumlunar mission as the "logical intermediate step" toward future goals of lunar and planetary landing. Essential to the guidelines were plans for advanced earth-orbital missions and an earth-orbiting space station.
 30. STG, "Apollo Technical Liaison Plan," 16 Nov. 1960, A200-1B, LCF; Langley to STG, "Langley appointments to Apollo technical liaison groups," 7 Dec. 1960, in Project Apollo files, LCF. Interestingly, John Houbolt was not appointed to any of the liaison groups. On the first NASA/Industry Apollo Technical Conference, see the *Wall Street Journal*, 18 July 1961. Among the many valuable papers given by Langley's John Becker to the Archives of Aerospace Exploration at Virginia Polytechnic Institute and State University is his file on the Lunar Mission Steering Group. On the cover of this file, Becker provides a brief written introduction to its contents. Inside is a copy of the Apollo Technical

Liaison Plan, with handwritten notes by Becker. For information about this file and others in the Archives of Aerospace Exploration, contact the special collections archivist at the university library in Blacksburg, Va.

31. Houbolt, "Considerations of the Rendezvous Problems for Space Vehicles," p. 1.
32. NASA Langley, "Minutes of Meeting of LRC Manned Space Laboratory Group," 5 Feb. 1960, A200-4, LCF. See paragraphs 3 and 10.
33. William A. Mrazek, Marshall Space Flight Center, to John C. Houbolt, 16 May 1960, B10-6, LCF; Houbolt interview, 24 Aug. 1989, p. 11.
34. John C. Houbolt, "Lunar Rendezvous," *International Science and Technology* 14 (Feb. 1963): 63. Several attempts have been made to clarify the detailed history of the genesis of LOR at Langley and Houbolt's role in it. The best efforts to date are: Hacker and Grimwood, *On the Shoulders of Titans*, pp. 14–16 and 60–68; John M. Logsdon, "The Choice of the Lunar Orbital Rendezvous Mode," in *Aerospace Historian* (June 1971): 63–70; and Murray and Cox, *Apollo*, chaps. 8 and 9. However, none of these are complete, and none fully satisfy the Langley participants involved: Houbolt, Michael, Brown, et al. In a footnote to their excellent book on Project Apollo, Murray and Cox remark on the gaps in the overall LOR story, suggesting that "there is a fascinating doctoral dissertation yet to be written on this episode." This chapter may not close off the possibility of a doctoral dissertation, but my goal in writing it was to fill in many of the gaps and stress Langley's role in LOR.
35. Houbolt interview, 24 Aug. 1989, p. 15; Hacker and Grimwood, *On the Shoulders of Titans*, pp. 15–16.
36. "RCA Will Do Saint Payload," *Aviation Week and Space Technology* 5 (Dec. 1960): 27. For other sources on Project Saint, see Hacker and Grimwood, *On the Shoulders of Titans*, p. 416 n. 64.
37. Houbolt interview, 24 Aug. 1989, pp. 16 and 21–25. On Houbolt's final chart were three conclusions: (1) "RENDEZVOUS OPENS POSSIBILITY FOR EARLIER ACCOMPLISHMENT OF CERTAIN SPACE MEASUREMENT WITH EXISTING VEHICLES"; (2) "THERE IS A NEED FOR RAPID DEVELOPMENT OF MANNED RENDEZVOUS TECHNIQUES—SHOULD MAKE USE OF MERCURY AND 'SAINT' TECHNOLOGY"; and (3) "NASA SHOULD HAVE MANNED RENDEZVOUS PROGRAM IN LONG-RANGE PLANS WITH OBJECTIVES OF EXPEDITING SOFT LUNAR LANDINGS AND FLEXIBLE ORBITAL OPERATIONS."
38. Murray and Cox, *Apollo*, p. 116.
39. Houbolt interview, 24 Aug. 1989, pp. 17–18.
40. See the reference to Brown's presentation in Charles J. Donlan to NASA headquarters, director of the staff, Inventions and Contributions Board, 1 Mar. 1974, author's LOR file. John D. Bird also refers to it in "A Short History of the Development of the Lunar-Orbit-Rendezvous Plan," p. 2.
41. The preceding two paragraphs are derived from my unsigned feature story, "The Rendezvous That Was Almost Missed: Lunar-Orbit Rendezvous and the Apollo Program," NASA News Release No. 89-98, 7 July 1989, pp. 5–6.
42. Hacker and Grimwood, *On the Shoulders of Titans*, pp. 28–29.
43. *Ibid.*, and Ertel and Morse, *The Apollo Spacecraft: A Chronology*, 1:66.
44. Houbolt interview, 24 Aug. 1989, pp. 21–26.

Notes for Chapter 8

45. John I. Cumberland, executive secretary, SEPC, to members and speakers, "Agenda for SEPC Meeting, Jan. 5-6, 1961," A200-1B, LCF.
46. Hacker and Grimwood, *On the Shoulders of Titans*, p. 29.
47. Robert L. O'Neal to Charles J. Donlan, associate director, "Discussion with Dr. Houbolt, LRC, concerning the possible incorporation of a lunar orbital rendezvous phase as a prelude to manned lunar landing," 30 Jan. 1961, A200-1B, LCF.
48. *Ibid.*, p. 60; Owen Maynard to Frederick J. Lees, chairman, NASA Inventions and Contributions Board, 13 Nov. 1982, copy in author's LOR file. In truth, Houbolt's numbers were overly optimistic in estimating the required weights for the LEM, because in some critical areas detailed information about the necessary subsystems was not available. Subsequent analysis by NASA and its industrial contractors provided much more realistic weight numbers. Still, the later values for these weights did not turn out to be so radically different than Houbolt's projections: they were within the single-launch capability of the Saturn V vehicle and therefore validated the advertised feasibility of the LOR mode for the manned lunar landing mission.
49. Von Braun quoted in Murray and Cox, *Apollo*, pp. 116-117. Quote expressing skepticism about LOR from Dr. Harvey Hall to director of the staff, NASA Inventions and Contributions Board, 28 Mar. 1973, author's LOR file.
50. Murray and Cox, *Apollo*, p. 117.
51. Houbolt interview, 24 Aug. 1989, p. 22.
52. Gilruth to Kemmett, 28 Aug. 1973, p. 1.
53. Donlan to director of the staff, NASA Inventions and Contributions Board, 1 Mar. 1974, p. 2.
54. Gilruth to Kemmett, 28 Aug. 1973, p. 1.
55. Gilruth to Nicholas E. Golovin, 12 Sept. 1961, quoted in Hacker and Grimwood, *On the Shoulders of Titans*, p. 61.
56. The quoted phrases are from Houbolt's letters to Francis W. Kemmett, NASA Inventions and Contributions Board, 23 May 1978 and 2 Sept. 1981, copies in author's LOR file.
57. George Low, "A Plan for Manned Lunar Landing," 24 Jan. 1961, A200-1B, LCF. On the cover sheet of this report, Low identifies the members of his Lunar Landing Working Group; Houbolt's name is not included. George M. Low, president, Rensselaer Polytechnic Institute, Troy, N.Y., to Mr. Frederick J. Lees, NASA Inventions and Contributions Board, 21 Oct. 1982, copy in author's LOR file. See also E. O. Pearson, "Notes on Key Problems of Manned Lunar Missions," 13 Jan. 1961, A200-1B, LCF. The phrase "extremely far-out thing to do" is George Low's, quoted in Murray and Cox, *Apollo*, p. 117.
58. Low to Lees, 21 Oct. 1982, p. 2.
59. See M. J. Queijo to associate director, "Techniques and problems associated with manned lunar orbits and landings," 21 Feb. 1961, A200-1B, LCF.
60. Bernard Maggin to John Houbolt, 1 Mar. 1961, A200-1B, LCF.
61. Brown interview, 17 July 1989. The politics also involved at least one major industrial firm, North American Aviation in Los Angeles, which already had a contract for a command-and-service module based on the direct-ascent mode. If NASA selected LOR, North American most probably would have to "share the pie" with some other contractor who would be responsible for the separate lunar lander. The other contractor

- turned out to be Grumman. For more on the politics of the mission-mode decision, see Henry S. F. Cooper, "We Don't Have to Prove Ourselves" in *The New Yorker* (2 Sept. 1991): 64.
62. NASA Langley, "Work at LRC in Support of Project Apollo," 3 May 1961, Project Apollo file, LCF. See also Rufus O. House to the Langley director, "Number of professionals in support of Project Apollo," 19 May 1961, Project Apollo file, LCF. This memo advised center management that 326.5 professionals were currently involved in research projects supporting Apollo; 91 of these professionals were involved in the study of reentry heating problems.
 63. Loftin interview, 5 Aug. 1989, p. 93.
 64. NASA Langley, "Manned Lunar Landing Via Rendezvous," 19 Apr. 1961, A200-1B, LCF.
 65. Hacker and Grimwood, *On the Shoulders of Titans*, p. 61.
 66. Houbolt interview, 24 Aug. 1989, p. 30.
 67. *Ibid.*, p. 28.
 68. Hacker and Grimwood, *On the Shoulders of Titans*, p. 61.
 69. *Ibid.*
 70. See McDougall, *Heavens and the Earth*, pp. 8, 318, and 328, and Murray and Cox, *Apollo*, pp. 79–80.
 71. For an analysis of Vice-President Lyndon Johnson's enthusiasm for the lunar mission, see McDougall, *Heavens and the Earth*, pp. 319–320, and Logsdon, *Decision to Go to the Moon*, pp. 119–121.
 72. For a more complete analysis of the political thinking behind Kennedy's lunar commitment, see chap. 15 "Destination Moon" (pp. 307–324) of McDougall, *Heavens and the Earth*.
 73. John C. Houbolt to Dr. Robert C. Seamans, Jr., NASA associate administrator, 9 May 1961, copy in box 6, Milton Ames Collection, LHA.
 74. Hacker and Grimwood, *On the Shoulders of Titans*, p. 36; Murray and Cox, *Apollo*, pp. 81–82 and 110. The Fleming Committee had 23 members, including 18 from NASA headquarters; Langley had no representative. The committee members from headquarters were Fleming, Addison M. Rothrock, Albert J. Kelley, Berg Paraghamian, Walter W. Haase, John Disher, Merle G. Waugh, Eldon Hall, Melvyn Savage, William L. Lovejoy, Norman Rafel, Alfred Nelson, Samuel Snyder, Robert D. Briskman, Secrest L. Barry, James P. Nolan, Jr., Earnest O. Pearson, and Robert Fellows. The other members were Heinz H. Koelle (Marshall), Kenneth S. Kleinknecht and Alan Kehlet (STG), A. H. Schichtenberg (The Lovelace Foundation), and William S. Shipley (JPL). Not surprisingly, most of these men were big-rocket specialists.
 75. Seamans to director, Launch Vehicle Programs (Don R. Ostrander) and director, Advanced Research Programs (Ira H. Abbott), "Broad Study of Feasible Ways for Accomplishing Manned Lunar Landing Mission," 25 May 1961, A200-1B, LCF.
 76. Seamans, "Broad Study." Seamans, associate administrator, to John C. Houbolt, NASA Langley, 2 June 1961, copy in box 6, Milton Ames Collection, LHA.
 77. Murray and Cox state that Houbolt was a member of the Lundin Committee (*Apollo*, p. 118). Loftin interview, 5 Aug. 1989, pp. 91–97; Houbolt interview, 24 Aug. 1989, pp. 32–34. In reading a preliminary draft of this chapter, Loftin challenged Houbolt's statement. Loftin insists that he spent weeks in Washington on this committee and only

Notes for Chapter 8

sent Houbolt in his place the few times he could not attend a meeting. Other members of the Lundin Committee, besides Lundin and Loftin, were Walter J. Downhower (JPL), Alfred E. Eggers (Ames), Harry O. Ruppe (Marshall), and Lt. Col. George W. S. Johnson (U.S. Air Force). Unlike the Fleming Committee, this task force—by design—had no members from NASA headquarters and was conceived to represent the technical judgments of the NASA centers.

78. Laurence K. Loftin, Jr., told this story from the audience during the videotaped celebration program for the 20th anniversary of the Apollo 11 lunar landing. See also Loftin interview, 5 Aug. 1989, p. 93.
79. Houbolt interview, 24 Aug. 1989, pp. 33–34. NASA (Lundin Committee), “A Survey of Various Vehicle Systems for the Manned Lunar Landing Mission,” 10 June 1961, A200-1B, LCF.
80. *Ibid.*, p. 16; Houbolt interview, 24 Aug. 1989, p. 34.
81. Houbolt interview, 24 Aug. 1989, p. 33; see also Murray and Cox, *Apollo*, p. 118.
82. Loftin interview, 5 Aug. 1989, pp. 93–94.
83. Seamans to directors for Launch Vehicle Programs, Advanced Research Programs, and to acting director for Life Sciences Program, “Establishment of Ad Hoc Task Group or Manned Lunar Landing by Rendezvous Techniques,” 20 June 1961, A200-1B, LCF. See also Hacker and Grimwood, *On the Shoulders of Titans*, pp. 37–38. Serving on the Heaton Committee were 10 officials from NASA headquarters, 5 from Marshall, 1 from the Flight Research Center, and 2 from Langley, Houbolt and W. Hewitt Phillips. One representative from the U.S. Air Force was also a member.
84. Houbolt’s paper “Problems and Potentialities of Space Rendezvous,” first presented at the International Academy of Astronautics’ International Symposium on Space Flight and Reentry Trajectories, was published under the same title in *Astronautica Acta* 7 (1961): 406–429.
85. Houbolt interview, 29 Aug. 1989, p. 39.
86. For the conclusions of the Heaton Committee, see Ad Hoc Task Group for Study of Manned Lunar Landing by Rendezvous Techniques, “Earth Orbital Rendezvous for an Early Manned Lunar Landing,” pt. 1, “Summary Report of Ad Hoc Task Group Study,” Aug. 1961. Houbolt interview, 29 Aug. 1989, p. 39.
87. Murray and Cox, *Apollo*, p. 119. See also Houbolt interview, 24 Aug. 1989, p. 46.
88. Houbolt interview, 24 Aug. 1989, pp. 47–48.
89. *Ibid.*
90. *Ibid.*
91. “Report of DOD-NASA Large Launch Vehicle Planning Group, Vol. 1, 1961,” A200-1B, LCF. See Hacker and Grimwood, *On the Shoulders of Titans*, pp. 67–68. The members of this committee, besides those mentioned in the text, were: Kurt R. Stehling and William A. Wolman (NASA headquarters); Warren H. Amster and Edward J. Barlow (Aerospace Corp.); Seymour C. Himmel (Lewis); Wilson Schramm and Francis L. Williams (Marshall); Col. Matthew R. Collins (army); Rear Adm. Levering Smith and Capt. Lewis J. Stecher, Jr. (navy); and Col. Otto J. Glaser, Lt. Col. David L. Carter, and Heinrich J. Weigand (air force). No Langley representatives were on the committee.
92. Bird, “A Short History of the Development of the Lunar-Orbit-Rendezvous Plan,” final supplement, 17 Feb. 1966, p. 3.

93. Harvey Hall, NASA coordinator, NASA/DOD Large Launch Vehicle Planning Group, to Langley, 23 Aug. 1961, A200-1B, LCF.
94. Houbolt interview, 24 Aug. 1989, p. 49.
95. Hacker and Grimwood, *On the Shoulders of Titans*, pp. 55-60.
96. *On the Shoulders of Titans* is an outstanding, detailed history of the Gemini Program. For a more brief and somewhat more colorful insight into this important preparatory program for the Apollo mission, see Michael Collins, *Liftoff: The Story of America's Adventure in Space* (New York: NASA/Grove Press, 1988), pp. 63-113. See also Collins' memoir *Carrying the Fire: An Astronaut's Journeys* (New York: Macmillan Co., 1977). Collins, the CM pilot for the Apollo 11 mission to the moon, was also an astronaut in the Gemini program (Gemini-Titan X, 18-21 July 1966). His memoir is one of the best books about the manned space program of the 1960s. On Gemini's relationship to MORAD, see Houbolt interview, 24 Aug. 1989, pp. 49-50.
97. NASA Langley, *Manned Lunar-Landing through Use of Lunar-Orbit Rendezvous*, 2 vols., 31 Oct. 1961, copy in box 6, Milton Ames Collection, LHA. Other Langley researchers who made contributions to this two-volume report were Jack Dodgen, William Mace, Ralph W. Stone, Jack Queijo, Bill Michael, Max Kurbjun, and Ralph Brissenden. In essence, Houbolt and associates prepared this report as a working paper that could provide, as NASA Deputy Administrator Hugh L. Dryden would later explain, "a quick summary of the information then available on LOR as a mode of accomplishing manned lunar landing and return." See Dryden to the Honorable Clinton P. Anderson, chairman, Committee on Aeronautical and Space Sciences, U.S. Senate, 11 Apr. 1963, A200-1B, LCF.
98. John C. Houbolt to Robert C. Seamans, associate administrator, NASA, 15 Nov. 1961, p. 1, copy in box 7, Milton Ames Collection, LHA.
99. *Ibid.*, p. 1.
100. Robert C. Seamans, Jr., to Dr. John C. Houbolt, 4 Dec. 1961, box 6, Milton Ames Collection, LHA.
101. George M. Low, president, Rensselaer Polytechnic Institute, Troy, N.Y., to Mr. Frederick J. Lees, chairman, Inventions and Contributions Board, NASA, 21 Oct. 1982, copy in author's LOR file. See also Murray and Cox, *Apollo*, p. 120.
102. For an excellent capsule portrait of Dr. Joseph F. Shea, see Murray and Cox, *Apollo*, pp. 120-125.
103. *Ibid.*, p. 124.
104. *Ibid.*
105. *Ibid.*, p. 125.
106. On Glenn's historic flight, see Loyd S. Swenson, James H. Grimwood, and Charles C. Alexander, *This New Ocean: A History of Project Mercury*, NASA SP-4201 (Washington, 1966), pp. 420-436. For more on the Chance Vought contract, see Ertel and Morse, *Apollo Spacecraft: A Chronology*, 1:141. On the Chance Vought team briefing, see Bird, "A Short History of the Development of the Lunar-Orbit-Rendezvous Plan," supplemented 17 Feb. 1966, p. 4. Regarding the headquarters meeting, see NASA, "Minutes of Lunar Orbit Rendezvous Meeting, April 2-3, 1962," copy in A200-1B, LCF. See also Ertel and Morse, *Apollo Spacecraft: A Chronology*, 1:147-152.
107. Arthur W. Vogeley interview with author, Hampton, Va., 17 July 1989, videotape, LHA.

Notes for Chapter 8

108. Faget quoted in Henry S. F. Cooper, "We Don't Have to Prove Ourselves," p. 64.
109. Ibid. For details of the Manned Spacecraft Center's final evaluation in favor of LOR, see Charles W. Matthews, chief, Spacecraft Research Division, MSC, to Robert R. Gilruth, MSC director, "Summary of MSC Evaluation of Methods for Accomplishing the Manned Lunar Landing Mission," 2 July 1962; and Robert R. Gilruth to NASA headquarters ("Attn: Mr. D. Brainerd Holmes"), "Summary of Manned Spacecraft Center evaluation methods for accomplishing the manned lunar landing mission," 5 July 1962. Both memoranda are included in app. A of the NASA Office of Manned Space Flight's confidential 169-page report, *Manned Lunar Landing Program Mode Comparison*, 30 July 1962.
110. Gilruth to Kemmett, 28 Aug. 1973.
111. See Murray and Cox, *Apollo*, p. 125.
112. Ibid.
113. Low to Lees, 21 Oct. 1982; Low to John C. Houbolt, Senior Vice-President and Senior Consultant, Aeronautical Research Associates of Princeton, 7 Aug. 1969, copies in author's LOR file.
114. Axel T. Mattson, research assistant for Manned Spacecraft Projects, to Charles J. Donlan, "Report on activities (April 16–April 19, 1962) regarding Manned Spacecraft Projects," A189-5, LCF. Mattson's memo lists all personnel that Houbolt saw at the Manned Spacecraft Center. One of the Houston engineers with whom Houbolt and Bird met, Chuck Matthews, had just returned from a meeting at NASA Marshall. There Matthews had reviewed Houston's thinking on the LOR concept. According to Mattson's memo, that presentation was "apparently well received by von Braun, since he made favorable comments." See also Mattson interview with author, Hampton, Va., 14 Aug. 1989, transcript, LHA.
115. Statement by Axel T. Mattson at the 17 July 1989 evening program on the 20th anniversary of Apollo 11, videotape, LHA.
116. "Minutes of the MSF Management Council," 6 Feb. 1962, p. 1, A200-1B, LCF; Houbolt interview, 24 Aug. 1989, p. 64.
117. Brown interview, 17 July 1989; Houbolt interview, 24 Aug. 1989, pp. 68–72.
118. "Concluding Remarks by Dr. Wernher von Braun about Mode Selection for the Lunar Landing Program Given to Dr. Joseph F. Shea, Deputy Director (Systems) Office of Manned Space Flight," 7 June 1962, copy in box 6, Milton Ames Collection, LHA. For more on von Braun's surprise announcement in favor of LOR and the reaction of the Marshall audience to it, see Murray and Cox, *Apollo*, p. 139.
119. For an introduction to the concept of "closure" in science and technology, see *The Social Construction of Technological Systems: New Directions in the Sociology and History of Technology*, eds., Wiebe E. Bijker, Thomas P. Hughes, and Trevor Pinch (Cambridge and London: MIT Press, 1990), pp. 12–13.
120. John C. Houbolt to Dr. Wernher von Braun, director, NASA Marshall, 9 Apr. 1962, A189-7, LCF; von Braun to Houbolt, 20 June 1962, copy in author's LOR file. Von Braun argued later that he really had not changed his mind from EOR to LOR; he had not been that strong a supporter of EOR in the first place. His people at Marshall had investigated EOR, and Gilruth's people in Houston had investigated LOR, but that was part of a NASA management strategy to cover all the options thoroughly. He claims he

personally did not take sides until he had all the facts. When he did, he supported LOR. See Murray and Cox, *Apollo*, p. 139.

121. NASA, "Lunar Orbit Rendezvous: News Conference on Apollo Plans at NASA Headquarters on July 11, 1962," copy, box 6, Milton Ames Collection, LHA. In the press conference, Dr. Robert Seamans credited John Houbolt specifically for his contribution to the LOR concept: "I would first like to say that when I joined NASA almost two years ago one of the first places that I went to was Langley Field, and there reviewed work going on on a research basis under Dr. John Houbolt. This work related both to rendezvous and what a man could do at the controls, of course under simulated conditions, as well as the possibility of lunar orbit rendezvous" (p. 8). On Wiesner's opposition to LOR, see McDougall, *Heavens and the Earth*, p. 378, and Murray and Cox, *Apollo*, pp. 140–143.

Even after its July 1962 announcement in favor of LOR, NASA continued to evaluate the other major options for the Apollo mission mode. See, for example, the Office of Manned Space Flight's confidential *Manned Lunar Landing Program Mode Comparison*, 30 July 1962, and the follow-up, *Manned Lunar Landing Mode Comparison*, 24 Oct. 1962. Copies of both documents are in A200-1B, LCF. Both reports concluded that on the basis of "technical simplicity, scheduling, and cost considerations," LOR was the "most suitable" and the "preferred mode." Some forms of EOR were also feasible and would have adequate weight margins.
122. John C. Houbolt, Roy Steiner, and Kermit G. Pratt, "Flight Data and Considerations of the Dynamic Response of Airplanes to Atmospheric Turbulence," July 1962.
123. Houbolt interview, 24 Aug. 1989, p. 73.
124. I. E. Garrick, Distinguished Research Associate, NASA Langley, to Mr. Francis W. Kemmett, Inventions and Contributions Board, NASA headquarters, 18 Nov. 1974. Garrick wrote two other letters to Kemmett, dated 14 Nov. 1975 and 12 Sept. 1978. Copies of all three are in author's LOR file.
125. Low to Lees, 21 Oct. 1982, pp. 2–3.
126. On 7 Aug. 1969, two weeks after the successful completion of the Apollo 11 mission, von Braun wrote Houbolt a personal letter in which he referred to Houbolt's "singular contribution to the Apollo program." "We know that it must be highly gratifying to you because of the rousing and complete success of your Eagle. The LM concept that you developed and defended so effectively—even, on occasion, before unsympathetic tribunals—was indeed a prime factor in the success of man's first lunar landing mission." Wernher von Braun, director, NASA Marshall, to John C. Houbolt, senior vice-president and senior consultant, Aeronautical Research Associates of Princeton, Princeton, N.J., 7 Aug. 1969, copy in author's LOR file.

Throughout this chapter, I have often called Houbolt "a crusader," knowing all too well that this association has plagued Houbolt for nearly 30 years. This characterization of Houbolt is one of the major factors that killed his chances for receiving a \$100,000 cash award from a NASA inventions and contributions board in the late 1970s and early 1980s. This board decided after a lengthy inquiry that it did not give awards to individuals who simply advocated or "crusaded" for causes—however righteous.

The NASA awards board perhaps significantly underestimated the sometimes vital role of a crusader in the ultimate success of a major technological endeavor. Most certainly in this case the awards board worked from far too literal a definition of "crusader,"

Notes for Chapter 9

because Houbolt was not just arguing for something for which other people were more responsible. He made LOR a personal cause only after his own extensive work on the relevant problems. "Not until I showed them all my analysis and so forth did the awards committee even realize that I had gone into so much depth in terms of working through all the various parts of the problem," says Houbolt.

Chapter 9

Skipping "The Next Logical Step"

Much of the information expanded upon in this chapter is based on an earlier unpublished essay, "Visions of Man in Space: NASA Langley Research Center and the United States Space Station Program," by Beverly C. McMillan and James R. Hansen, final revision, Sept. 1992. I would like to thank Ms. McMillan for her valuable assistance in clarifying the early history of space station research at Langley.

1. Von Puttkamer quoted in Charles R. Pelligrino and Joshua Stoff, *Chariots for Apollo* (N.Y.: Atheneum, 1986), pp. 24–25.
2. For an analysis of the long and twisting political history of NASA's attempt to develop and operate an orbiting space station, see Howard E. McCurdy, *The Space Station Decision: Incremental Politics and Technological Choice* (Baltimore & London: Johns Hopkins University Press, 1990), and Sylvia D. Fries, "2001 to 1994: Political Environment and the Design of NASA's Space Station System," *Technology and Culture* 29 (July 1988): 568–593. On the operational history and demise of Skylab, see Michael Collins, *Liftoff: The Story of America's Adventure in Space* (New York: NASA/Grove Press, 1988), pp. 163–200, as well as James E. Oberg's insightful essay, "Skylab's Untimely End," in *Air & Space/Smithsonian* 6 (Feb./Mar. 1992): 73–79. My assertion that space station designers deliberately designed Skylab for only a short stay in space so that they could replace it with a more elaborate station is based on personal interviews with key NASA officials involved in space station work; they wish to remain anonymous.
3. K. E. Tsiolkovskii, *Investigation of Universal Space by Means of Reactive Devices* (1911 and 1926), NASA translations in Tsiolkovskii, *Works on Rocket Technology*, Nov. 1965, HQA; Hermann Oberth, *Die Rakete zu den Planetenraumen* (1923), NASA translation in HQA; and Guido von Pirquet, "Fahrtrouten," in *Die Rakete* (May 1923 to Apr. 1929). For a summary of the pioneering ideas on space stations, see McCurdy, *Space Station Decision*, pp. 5–8. On Tsiolkovskii specifically, see I. A. Kol'chenko and I. V. Strazheva, "The Ideas of K. E. Tsiolkovskii on Orbital Space Stations," in *History of Rocketry and Astronautics*, ed. R. Cargill Hall (San Diego: American Astronautical Society, 1986), pp. 170–176; on Pirquet, see Fritz Sykora, "Guido von Pirquet: Austrian Pioneer of Astronautics," in *History of Rocketry and Astronautics*, pp. 140–156.

For a summary and analysis of early space station proposals, see the following essays: Frederick I. Ordway III, "The History, Evolution, and Benefits of the Space Station Concept," presented to the 13th International Congress of the History of Science, Aug. 1971, copy in HQA; Barton C. Hacker, "And Rest as in a Natural Station: From Space Station to Orbital Operations in Space-Travel Thought, 1885–1951," unpublished manuscript, [undated], HQA; Alex Roland, "The Evolution of Civil Space

- Station Concepts in the United States,” unpublished manuscript, May 1983, HQA; and John M. Logsdon, “The Evolution of Civilian In-Space Infrastructure, i.e., ‘Space Station’ Concepts in the United States,” in *Civilian Space Stations and the U.S. Future in Space* (Washington: U.S. Congress, Office of Technology Assessment, OTA-STI-241, Nov. 1984).
4. Wernher von Braun, “Crossing the Last Frontier,” *Collier’s* 129 (22 Mar. 1952): 24–29 and 72–74. For the other articles in this special issue of *Collier’s* devoted to the theme of space exploration, see “Man Will Conquer Space Soon.”
 5. Von Braun, “Crossing the Last Frontier,” pp. 24–25.
 6. *Ibid.* For additional information and thoughts on von Braun’s space station concept, see McCurdy, *Space Station Decision*, pp. 5–7, and Christopher Lampton, *Wernher von Braun* (New York: Franklin Watts, 1988), p. 106.
 7. [Laurence K. Loftin, Jr.], “Manned Space Flight Proposal” [Summer 1959]; Harry J. Goett to Research Steering Committee on Manned Space Flight, “Plans for May 25–26 Meeting,” 6 May 1959. Both documents can be found in the Floyd L. Thompson Collection, LHA. See also the Minutes of the Research Steering Committee on Manned Space Flight, 25–26 May 1959, copy in HQA.
 8. Laurence K. Loftin, “Manned Space Flight Proposal,” pp. 2–4. For a brief analysis of the X-20 Dyna-Soar program, see Walter A. McDougall, *The Heavens and the Earth: A Political History of the Space Age* (New York: Basic Books, 1985), pp. 190–191 and 339–341.
 9. Loftin interview with author, Newport News, Va., 5 Aug. 1989.
 10. [Laurence K. Loftin, Jr.], untitled talk at the 1959 NASA inspection [Fall 1959], AMIS Committee file, Thompson Collection, LHA.
 11. *Ibid.*; Loftin interview, 5 Aug. 1989. In his inspection presentation, Loftin expressed many of the same ideas that he had offered at the second meeting of the Research Steering Committee on Manned Space Flight, held at Ames Research Center, on 25–26 May 1959. A copy of the minutes of this meeting is preserved in the HQA.
 12. Mark R. Nichols interview with author, Hampton, Va., 6 July 1988, transcript, p. 3, OHC, LHA.
 13. [Laurence K. Loftin, Jr.], “Manned Space Laboratory Research Group,” [Fall 1959], an organization chart with handwritten notes on attached page by Floyd Thompson, AMIS Committee file, Thompson Collection, LHA.
 14. *Ibid.*
 15. Loftin interview, 5 Aug. 1989. See also McCurdy, *Space Station Decision*, pp. 8–9.

Industry’s early interest in the space station can be seen in several documents in file A200-1A, LCF. For example, see J. O. Charshafian, general manager, Santa Barbara Division, Curtiss-Wright Corporation, to E. C. Draley, assistant director, NASA Langley, “NASA Assistance on Aerial Platform,” 19 May 1959; Beverly Z. Henry, Jr., to Associate Director [Thompson], “Visit of Goodyear Aircraft Corporation representatives to the Full-Scale Research Division,” 19 Oct. 1959; Ralph W. Stone, Jr., to Associate Director [Thompson], “Visits of Messrs. A. B. Thompson and Paul Petty of Chance Vought Astronautics to Langley, November 6, 1959,” 12 Nov. 1959; Beverly Z. Henry, Jr., to Associate Director [Thompson], “Visit of the Martin Company representatives on January 12, 1960,” 26 Jan. 1960.

Notes for Chapter 9

16. [Loftin], untitled talk at the 1959 NASA inspection, p. 1; Loftin interview, 5 Aug. 1989.
17. Emanuel Schnitzer, "Erectable Torus Manned Space Laboratory," 16 May 1960, A200-4, LCF. See also Schnitzer to Associate Director [Thompson], "Space Station Project—Results of discussions at NASA Headquarters on May 10–11, 1960," 23 May 1960, A200-4, LCF.
18. Schnitzer to Associate Director [Thompson], "Transmittal of updated article on Erectable Torus Manned Space Laboratory to the American Rocket Society," 24 Oct. 1960, A200-4, LCF. Several documents from 1960 and 1961 pertaining to the work on the inflatable torus are in A200-4, LCF. See also W. Ray Hook, "Space Stations—Historical Review and Current Plans," unpublished paper presented at the winter annual meeting of the American Society of Mechanical Engineers, Phoenix, 14–19 Nov. 1982, Langley Technical Library. Hook is a Langley engineer who has been involved with space station work since the 1960s.
19. On the wobble problem, see Peter R. Kurzhals, James J. Adams, and Ward F. Hodge, "Space Station Dynamics and Control," in NASA Langley, *A Report on the Research and Technological Problems of a Manned Rotating Spacecraft*, NASA TN D-1504 (Washington, Aug. 1962), pp. 71–72.
20. Floyd L. Thompson to NASA, "100-foot diameter automatic erecting modular space station—Request for approval of study contract," 9 June 1961, A200-4, LCF. For design information, see Rene Berglund, "Space Station Research Configurations," in NASA TN D-1504, pp. 9–21. For an analytical summary of Langley's designs of the inflatable torus and rotating hexagon, see Fries, "2001 to 1994," pp. 572–578. The opening paper of TN D-1504, "Space Station Objectives and Research Guidelines" by Paul R. Hill and Emanuel Schnitzer (pp. 1–9), offers a general statement of early Langley goals and ambitions regarding its space station work with both the inflatable torus and rotating hexagon concepts. For North American's presentation of the hexagon concept, see North American Aviation, "Self-Deploying Space Station, Final Report," SID 62-1302, 31 Oct. 1962, Langley Technical Library.
21. Emanuel Schnitzer, memorandum for files, "Results of Space Station Conference between NASA Headquarters and Goodyear Aircraft Corporation," 21 Apr. 1961, A200-4, LCF. For insights into the turbulent history of the Centaur development, see Roger Bilstein, *Stages to Saturn: A Technological History of the Apollo/Saturn Launch Vehicles*, NASA SP-4206 (Washington, 1980), esp. pp. 36–38, 43–46, and 131–137; and Virginia P. Dawson, *Engines and Innovation: Lewis Laboratory and American Propulsion Technology*, NASA SP-4306 (Washington, 1991), pp. 166–169, 179, and 188–193. On the matter of maneuvering a rendezvous with a rotating space station, see Roy F. Brissenden, "Some Considerations of the Operational Requirements for a Manned Space Station," in NASA TN D-1504, p. 97.
22. Low cited in Schnitzer, "Results of Space Station Conference," p. 1. Details concerning the design of the rotating hexagon can be found in Berglund, "Space Station Research Configurations," pp. 9–21.
23. Loftin quoted in U.S. House of Representatives, *Hearing Before the Committee on Science and Astronautics*, 87th Cong., 1st sess., 19 May 1961, pp. 5–9 and 12–18. For this committee's analysis of the situation, see U.S. House of Representatives, *Expandable Space Structures: Report of the Committee on Science and Astronautics*, 87th Cong.,

- 1st sess. (Washington: Government Printing Office, 1961), Serial m. Copies of both publications are in the Thompson Collection, LHA.
24. The quotes are from the *Hearing Before the Committee on Science and Astronautics*, pp. 12–13.
 25. See Kurzhals, Adams, and Hodge, “Space Station Dynamics and Control,” pp. 76–77. See also Hook, “Space Stations,” p. 4.
 26. For insights into Langley’s early thinking about the power requirements of the orbiting space station, see the records of the Nichols committee in A200-4, LCF, esp. the reports of the subcommittee on auxiliary power chaired by William J. O’Sullivan. The issues of the power supply for the inflatable torus and rotating hexagon are clarified in John R. Dawson and Atwood R. Heath, Jr., “Space Station Power Systems,” in NASA TN D-1504, pp. 59–71. For an account of the debate at Langley between those favoring solar and nuclear power for a space station, see Hook, “Space Stations,” p. 5, and listen to Beverly McMillan’s tape-recorded interview with Langley space station researcher William N. Gardner, Newport News, Va., 26 Sept. 1991, OHC, LHA. See also Gardner, “A Review of Langley Space Station Studies,” in *Compilation of Papers Presented at the Space Technology Symposium*, NASA Langley, Feb. 1969, Langley Technical Library.
 27. H. A. Storms, president, Space and Information Systems Division, North American Aviation, to Laurence K. Loftin, Jr., technical advisor to director, NASA Langley, “Transmittal of Proposal for Engineering Analysis of NASA Self-Erecting Space Station,” 14 July 1961, A200-4, LCF; Gardner interview with McMillan, 23 Sept. 1991. On the development of nuclear reactors for the space program, see William R. Corliss, *SNAP Nuclear Space Reactors* (Washington: U.S. Atomic Energy Commission, Sept. 1966). The Atomic Energy Commission initiated SNAP, which stood for Systems for Nuclear Auxiliary Power, in 1955 specifically to develop a nuclear power system for a space vehicle. The commission’s effort involved both nuclear reactors and radioisotope systems. NASA Langley researchers learned quite a bit about SNAP findings during the early 1960s, as they struggled to choose the right power plant for their space station designs. The first SNAP system actually to go into space was SNAP 10-A, a 500-watt system launched from Vandenberg AFB on 13 Apr. 1965. See Corliss, *SNAP*, pp. 59–66 and 108–118.
 28. See the reports of the Subcommittee on Radioisotope Power to the Langley MORL Technology Steering Committee from 1963 and 1964, A200-4, LCF.
 29. Dan C. Popma, Charles H. Wilson, and Franklin W. Booth, “Life Support Research for Manned Space Stations,” in NASA TN D-1504, pp. 107–120.
 30. *Ibid.*, pp. 108–112.
 31. W. Ray Hook interview with McMillan, Hampton, Va., 16 Sept. 1991, in OHC, LHA; Gardner to McMillan, 23 Sept. 1991.
 32. Hook interview with McMillan, 16 Sept. 1991.
 33. Joseph S. Algranti, Donald L. Mallick, and Howard G. Hatch, Jr., “Crew Performance on a Lunar-Mission Simulation,” in NASA TN D-1504, pp. 135–146.
 34. George W. Zender and John R. Davidson, “Structural Requirements of Large Manned Space Stations,” in NASA TN D-1504, pp. 33–44.
 35. *Ibid.*; Robert S. Osborne and George P. Goodman, “Material and Fabrication Techniques for Manned Space Stations,” in NASA TN D-1504, pp. 45–53.
 36. See Berglund, “Space Station Research Configurations,” pp. 12–15.

Notes for Chapter 9

37. Ibid., pp. 13–14.
38. Emanuel Schnitzer, memorandum for files, “Orbital Flight Test of 10-Foot Inflatable Space Station Model on Scout—Details,” 10 May 1961, A200-4, LCF.
39. Hill and Schnitzer, “Space Station Objectives and Research Guidelines,” p. 2. For similar statements about the ultimate use of a space station, as conceived at Langley in the early 1960s, see Loftin’s testimony in the *Hearing Before the Committee on Science and Astronautics*, pp. 6, 9, and 13–14.
40. Loftin’s testimony, pp. 13–14.
41. Hook, “Space Stations,” p. 4; see also the description of the MORL concept in the NASA Langley press release, “Industry Asked to Propose Manned Orbiting Research Laboratory Plans,” 24 Apr. 1963, A200-4, LCF.
42. NASA Langley press release, “Industry Asked to Propose Manned Orbiting Research Laboratory Plans.” Hook interview with McMillan, 16 Sept. 1991; Gardner interview with McMillan, 23 Sept. 1991.
43. Floyd L. Thompson, Langley Research Center Announcement No. 32–63, “Reorganization of Langley Research Center and reassignment of personnel effective June 10, 1963,” 6 June 1963; Thompson, Langley Research Center Announcement No. 33–63, “Changes in Organization of the Applied Materials and Physics Division,” 6 June 1963. Copies of both announcements are preserved in the Thompson Collection, LHA. For the minutes of the meetings of the Langley MORL Technology Steering Committee, as well as the weekly and (later) biweekly reports of the MORL Studies Office, see A200-4, LCF.
44. Gardner interview with McMillan, 23 Sept. 1963.
45. William N. Gardner, head, MORL Studies Office, to Associate Director [Donlan], “MORL Studies Office Weekly Report—Week ending June 22, 1963,” 24 June 1963, A200-4, LCF.
46. W. Nissim, Douglas Aircraft Co., “London *Daily Mail* Astronomical Space Observatory,” Douglas Report No. SM-36173, Nov. 1959, copy in Langley Technical Library.
47. C. C. Walkey, Contracts Division, Douglas Aircraft Company, to Laurence K. Loftin, Jr., “Unsolicited Proposal for Advanced Technology Studies Related to Orbiting Laboratories,” 13 July 1964, A200-4, LCF.
48. Charles J. Donlan, chairman, Source Evaluation Board, Langley Research Center Announcement No. 63–63, “Establishment of Technical Assessment Team for Evaluation of Manned Orbital Research Laboratory (MORL) Phase I Study, Douglas Contract NAS1-2974 and Boeing Contract NAS1-2975, for Comparative Studies and Preliminary Design of an MORL Concept,” 24 Sept. 1963, Thompson Collection, LHA.
49. NASA Langley press release, “NASA Selects Douglas to Continue Space Station Study,” 2 Dec. 1963, A200-4, LCF.
50. For some contemporary thoughts on manned space stations from a military vantage point, see John W. Massey, “Historical Resume of Manned Space Stations,” ABMA, Redstone Arsenal, Ala., Report No. DSP-TM-9-60, 15 June 1960, HQA. On the history of the U.S. military’s interest in a space station, see McCurdy, *Space Station Decision*, esp. pp. 101–105, 131–134, 149–150, 166–168, and 198–199. See also Emanuel Schnitzer’s 11-page report (once classified “Secret”), “Military Test Space Station—Details of Midterm Briefing at WADD [Wright Air Development Division—Wright Patterson AFB, Ohio]—Preliminary Station for Pre-1965, Feb. 7–9, 1961,” 23 Feb. 1961, as well as Alfred C. Loedding, ARDC [Air Research and Development Command] Liaison Office,

Notes for Chapter 9

Langley Research Center, memorandum for files, "Man in Space in 1963 for Military Planning," 6 July 1960; both documents are in A200-4, LCF. As yet, no complete (unclassified) history of the DOD's involvement in space station planning has been written.

51. Douglas Aircraft Company, Missile and Space Systems Division, "MORL: Manned Orbital Research Laboratory," Douglas Report SM-47966, Aug. 1964, Langley Technical Library. For Douglas's follow-up work, see "Report on the Optimization of the Manned Orbital Research Laboratory (MORL) System Concept," Douglas Report SM-46071, Sept. 1964, and "Report on the Development of the Manned Orbital Research Laboratory (MORL) System Utilization Potential," Douglas Report SM-48922, Jan. 1966. Copies of both are also available in the Langley Technical Library.
52. Douglas, "MORL," Aug. 1964, p. 3. For a historical summary of early space station work at Johnson Space Center in Houston, see Henry C. Dethloff, *Suddenly, Tomorrow Came . . . : A History of the Johnson Space Center*, NASA SP-4307 (Houston, 1993), pp. 188–196 and 221–226.
53. On the air force's MOL concept, see McCurdy, *Space Station Decision*, pp. 70 and 132–133, and McDougall, *Heavens and the Earth*, pp. 340–341. The DOD announced its plans for MOL in Dec. 1963, one day after terminating the X-20 Dyna-Soar program.
54. John R. Dawson, secretary, "Minutes of Meeting of Langley MORL Technology Steering Committee, October 28, 1963," 28 Oct. 1963, A200-4, LCF; NASA Langley press release, "NASA Selects Douglas," p. 1.
55. Gardner interview with McMillan, 23 Sept. 1991.
56. Robert S. Osborne interview with McMillan, Newport News, Va., 21 Nov. 1991.
57. Numerous references to the General Dynamics contract for the life-support system can be found in the minutes to the meetings of the Langley MORL Technology Steering Committee and in the weekly and biweekly reports of the MORL Studies Office from mid-1963 to 1964.
58. Hook interview with McMillan, 16 Sept. 1991; Gardner interview with McMillan, 23 Sept. 1991.
59. Osborne interview with McMillan, 21 Nov. 1991. See also the minutes of the meetings of the MORL Technology Steering Committee and the reports of the MORL Studies Office from late 1964 and 1965. On the Apollo Extension System Program, see Wernher von Braun and Frederick I. Ordway III, *Space Travel, A History*, 4th ed. (New York: Harper & Row, 1985), p. 225.
60. Charles W. Matthews, director of Apollo applications, NASA Manned Spacecraft Center, to Charles J. Donlan, acting director, NASA Langley, 25 Apr. 1968, A200-4, LCF; NASA Langley, MORL Studies Office, "Intermediate Orbital Workshop System Study, In-House Study Summary," 28 June 1968, Langley Technical Library. On the Apollo Applications Program, see Collins, *Liftoff*, pp. 164–165; von Braun and Ordway, *Space Travel: A History*, p. 225; Linda Neuman Ezell, *NASA Historical Data Book*, vol. 3, *Programs and Projects, 1969–1978*, NASA SP-4012 (Washington, 1988), pp. 56–57, 63–64, and 94–100.
61. MORL Studies Office, "Intermediate Orbital Workshop System Study," 28 June 1968, viewgraph LRC-8-2.
62. Ezell, *NASA Historical Data Book*, 3:100–101.

Notes for Chapter 10

63. See Robert R. Gilruth, "Manned Space Stations," in *Proceedings of the Fourth International Symposium on Bioastronautics and the Exploration of Space*, San Antonio, Tex., 24–27 Apr. 1968, pp. 153–177; also William J. Normyle, "NASA Aims at 100-Man Station," *Aviation Week & Space Technology*, 24 Feb. 1969, pp. 14–17.
64. Hook, "Space Stations," p. 6. For insights into the Apollo Applications Program and the plans leading to Skylab, see W. David Compton and Charles D. Benson, *Living and Working in Space: A History of Skylab*, NASA SP-4208 (Washington, 1983).
65. Compton and Benson, *Living and Working in Space*. See McCurdy, *Space Station Decision*, pp. 23–24; and Ezell, *NASA Historical Data Book*, 3:100–101. See also North American Rockwell, Space Division, "Space Station Program Phase B Definition, Second Quarterly Progress Report," Report SD 70-146, 13 Mar. 1970, and North American Rockwell, "Modular Space Station Phase B Extension, NASA Administrator's Review," Report SD 71-582, 3 Dec. 1971. Copies of both reports can be found in the Langley Technical Library.
66. McCurdy, *Space Station Decision*, pp. 27–28.
67. Gardner interview with McMillan, 23 Sept. 1991.
68. Hook interview with McMillan, Hampton, Va., 16 Sept. 1991.
69. Gardner interview with McMillan, 23 Sept. 1991.

Chapter 10

To Behold the Moon: The Lunar Orbiter Project

1. See R. Cargill Hall, *Lunar Impact: A History of Project Ranger*, NASA SP-4210 (Washington, 1977), p. 285, and Michael Collins, *Liftoff: The Story of America's Adventure in Space* (New York: NASA/Grove Press, 1988), p. 117.
2. Leonard Roberts, "Exhaust Jet-Dust Layer Interaction during a Lunar Landing," unclassified report presented at the 13th International Aeronautical Congress, Varna, Bulgaria, 24–28 Sept. 1962; "The Interaction of a Rocket Exhaust with the Lunar Surface," unclassified report presented at the Specialists' Meeting of the Fluid Dynamical Aspects of Space Flight, Marseilles, France, 20–24 Apr. 1964. Copies of both papers are in the Langley Technical Library.
3. See Hall's comprehensive and well told, *Lunar Impact*.
4. A complete history of the Surveyor program has not been published. In addition to Hall's *Lunar Impact*, see Homer E. Newell, *Beyond the Atmosphere: Early Years of Space Science*, NASA SP-4211 (Washington, 1980), pp. 263–272. A fine summary of Surveyor is contained in Linda Neuman Ezell, *NASA Historical Data Book*, vol. 2, *Programs and Projects 1958–1968*, NASA SP-4012 (Washington, 1988), pp. 325–331. For an analysis of NASA's problems in the management of the Surveyor project, see Erasmus H. Kloman, *Unmanned Space Project Management: Surveyor and Lunar Orbiter*, NASA SP-4901 (Washington, 1972).
5. The chairman of this Lunar Photographic Mission Study Group was Capt. Lee R. Scherer, a naval officer on assignment to NASA headquarters and a program engineer with the Surveyor project. In Oct. 1962, NASA gave him the job of heading the Office of Space Sciences/Office of Manned Space Flight working group, which was to identify what information about the moon would be most essential to the landing mission. See Scherer,

- Study of Agena-based Lunar Orbiters*, NASA headquarters, Office of Space Sciences, 25 Oct. 1962, copy in Langley Technical Library. See also Bruce K. Byers, *Destination Moon: A History of the Lunar Orbiter Program*, NASA TM X-3487 (Washington, 1977, multilith), pp. 20–23. Byers' study is the most complete history to date of Lunar Orbiter.
6. Kloman, *Unmanned Space Project Management*.
 7. Clinton E. Brown interview with author, Hampton, Va., 17 July 1989. Brown acted as Langley's spokesman in early discussions at NASA headquarters in 1963 regarding Langley's proposed management of the Lunar Orbiter program.
 8. Hall, *Lunar Impact*, p. 157.
 9. "NASA Minutes of the First Senior Council for the Office of Space Sciences," 7 June 1962, E1-2A, LCF. Also quoted in Hall, *Lunar Impact*, p. 157.
 10. Penetrometer Feasibility Study Group, Langley Research Center, "Preliminary Project Development Plan for a Lunar Penetrometer Experiment for the Follow-On Ranger Program," 18 Aug. 1961, Code N-101,24218, Langley Technical Library. See also the following memoranda: E. M. Cortright (for Abe Silverstein, director of Space Flight Programs), to Ira H. Abbott, director of Advanced Research Programs, "Lunar Surface Hardness Experiments," 29 June 1961; E. C. Kilgore, assistant chief, Engineering Division, to Charles J. Donlan, associate director, "Meeting at Jet Propulsion Laboratory on July 18, 1961, attended by representatives of Langley Research Center, Aeronutronics Division of Ford Motor Company, NASA Headquarters, and JPL, to discuss a penetrometer experiment for the follow-on Ranger program," 21 July 1961; John L. McCarty and George W. Brooks, "Visit to NASA Headquarters, Washington, D.C., by George W. Brooks and John L. McCarty, Vibration and Dynamics Section, DLD [Dynamic Loads Division], June 28, 1961, to discuss possible Lunar Penetrometer Experiment on Ranger Spacecraft," 7 July 1961; Floyd L. Thompson to NASA headquarters, "Lunar surface hardness experiments," 27 July 1961; and George W. Brooks to Associate Director Charles J. Donlan, "Langley action on lunar penetrometer experiment for Ranger follow-on program," 27 July 1961. All these memos are in LCF, A200-1B.
 11. See John L. McCarty and Huey D. Carden, "Impact Characteristics of Various Materials Obtained by an Acceleration-Time-History Technique Applicable to Evaluating Remote Targets," NASA TN D-1269, June 1962.
 12. Penetrometer Feasibility Study Group, "Preliminary Project Development Plan for a Lunar Penetrometer Experiment," p. 1.
 13. Kilgore to Donlan, "Meeting at Jet Propulsion Laboratory."
 14. Hall, *Lunar Impact*, p. 158.
 15. *Ibid.*, pp. 156–163.
 16. Oran Nicks quoted in Byers, *Destination Moon*, p. 26.
 17. Floyd L. Thompson to Dr. Eugene Emme, NASA historian, "Comments on draft of Lunar Orbiter History dated November 4, 1969," 22 Dec. 1969, in folder labeled "Lunar Orbiter Historical Notes" in Floyd L. Thompson Collection, LHA. See also Byers, *Destination Moon*, p. 25.
 18. Clinton E. Brown interview, 17 July 1989.
 19. *Ibid.* On 12 July 1961, six weeks after President Kennedy's lunar landing speech, three men in Clint Brown's Theoretical Mechanics Division—William H. Michael, Jr., Robert H. Tolson, and John P. Gapcynski—put forward a "Preliminary Proposal for a

Notes for Chapter 10

Circumlunar Photographic Experiment.” The idea essentially was to support the Apollo program by adapting the Ranger spacecraft so that it could perform a circumlunar mission that could take high-resolution color photographs during the lunar-approach phase of a “single-pass,” circumlunar trajectory. In the cover memorandum to this unpublished proposal, one of its authors, Bill Michael, wrote that “a desirable situation would be that of Langley having prime responsibility for the photographic experiment, in a role similar to that of chief experimenter in other specific experiments carried by the Ranger and other vehicles.” See William H. Michael, Jr., head, Mission Analysis Section, to Langley Associate Director Charles J. Donlan, “Preliminary Proposal for a Circumlunar Photographic Mission,” 17 July 1961. See also C. I. Cummings, Lunar Program Director, JPL, to Bernard Maggin, Office of Programs, NASA headquarters, 9 Nov. 1961, and Maggin to Clinton E. Brown, 14 Nov. 1961. Copies of the above documents are in LCF, A200-1B.

20. Israel Taback interview with author, Hampton, Va., 13 Aug. 1991.
21. Floyd L. Thompson to NASA headquarters (Attn: Capt. Lee Scherer), 6 Mar. 1963, A200-1B, LCF. Attached to this memo is a “system block diagram” for the Lunar Orbiter as well as the data from the mission reliability analysis.
22. On the genesis of NASA’s system for project management, see Robert L. Rosholt, *An Administrative History of NASA, 1958–1963*, NASA SP-4101 (Washington, 1966), pp. 145–158 and 273–276.
23. *NASA Management Manual*, pt. 1, *General Management Instruction*, Number 4-1-1, “Subject: Planning and Implementation of NASA Projects,” NASA GMI (Washington, 18 Jan. 1961), chap. 4, p. 4. See also Edgar M. Cortright interview with author, Yorktown, Va., July 1988, transcript, pp. 8–9, OHC, LHA.
24. Donald H. Ward, *One Engineer’s Life Relived* (Utica, Ky.: McDowell Publications, 1990), p. 61. Ward served as head of spacecraft launch operations for LOPO.
25. Taback interview, 13 Aug. 1991.
26. See Byers, *Destination Moon*, pp. 40–41.
27. See Dr. A. K. Thiel, STL, to Oran W. Nicks, director, Lunar and Planetary Programs, OSSA/NASA, Washington, D.C., 20 Sept. 1962, copy in Thompson Collection, LHA. See also Byers, *Destination Moon*, pp. 16–17.
28. See Byers, *Destination Moon*, pp. 43–44.
29. Interview with Sherwood Butler, Hampton, Va., 23 Aug. 1991. Butler was Langley’s chief procurement officer at the time. For an analysis of the benefits of incentives contracting for Lunar Orbiter, see Kroman, *Unmanned Space Project Management*, pp. 34–36. See also Byers, *Destination Moon*, pp. 39–40. For a contemporary news story covering the details of the novel incentives contract for Lunar Orbiter, see Richard G. O’Lone, “Orbiter is First Big NASA Incentive Job,” *Aviation Week & Space Technology* 79 (7 Oct. 1963): 32.
30. Taback interview, 13 Aug. 1991.
31. See Byers, *Destination Moon*, pp. 40–47.
32. *Ibid.*, pp. 43–44.
33. Taback interview, 13 Aug. 1991; see Byers, *Destination Moon*, p. 56.
34. Byers, *Destination Moon*, pp. 57–70.

Notes for Chapter 10

35. For the basics of the Lunar Orbiter camera system, see Leon J. Kosofsky and S. Calvin Broome, "Lunar Orbiter: A Photographic Satellite," paper presented to the Society of Motion Picture and Television Engineers, Los Angeles, 28 Mar.-2 Apr. 1965, copy in Langley Technical Library. Broome was head of the photo subsystem group in LOPO; Kosofsky was the camera expert in Lee Scherer's office at NASA headquarters. For a more general description of the photographic mission and the Eastman Kodak camera, see *The Lunar Orbiter* (revised Apr. 1966), a 38-page booklet prepared by Boeing's Space Division and published by NASA Langley, esp. pp. 18-20 and 22-26, and *The Lunar Orbiter: A Radio-Controlled Camera*, a glitzy 14-page brochure that was published by NASA Langley with Boeing's assistance after the Lunar Orbiter project had ended.
36. Kosofsky and Broome, "Lunar Orbiter: A Photographic Satellite." See also Israel Taback, "A Description of the Lunar Orbiter Spacecraft," reprinted in *Highlights of Astronomy* (Dordrecht, Netherlands: D. Reidel Publishing Co., 1968), p. 464. Taback presented this paper at the 13th General Assembly of the International Astronomical Union (IAU) in Prague, Czechoslovakia, 1967. At this meeting, renowned astronomers from all over the world took off their shoes and crawled around on the floor looking at a huge layout of photographs taken by the Lunar Orbiters.
37. Scherer, *Study of Agena-based Lunar Orbiters*; see Byers, *Destination Moon*, pp. 20-23.
38. Telephone interview with Thomas Costello of the Boeing Co., Colorado Springs, Colo., 15 Aug. 1961. Costello was an engineer with Boeing who worked on the company's proposal for Lunar Orbiter and then served as one of its project engineers from 1963 to 1966.
39. See "Boeing to Build Lunar Orbiter," *Aviation Week & Space Technology* 79 (30 Dec. 1963): 22; "NASA To Negotiate with Boeing for Lunar Orbiter Spacecraft," *NASA Langley Researcher*, 2 June 1963; and "NASA Explains Choice of Boeing over Hughes in Lunar Orbiter Award," *Missiles and Rockets* 14 (9 Mar. 1964): 13.
40. Dr. Trutz Foelsche, "Remarks on Doses Outside the Magnetosphere, and on Effects Especially on Surfaces and Photographic Films," paper presented at the Meeting to Discuss Charged Particle Effects, OART, 19-20 Mar. 1964, Washington, D.C., p. 8, copy in the Langley Technical Library.
41. Byers, *Destination Moon*, pp. 72-74.
42. See Lee R. Scherer, *The Lunar Orbiter Photographic Missions*, p. 2. This is a 20-page typescript booklet published by NASA Langley in late 1967.
43. Erasmus H. Kloman, "Organizational Framework: NASA and Langley Research Center," p. 7. This is a chapter draft from Kloman's comment copy of his subsequent *Unmanned Space Project Management*. In draft form, Kloman's book contained many more details including the names of responsible individuals, which were omitted in the shortened version published by NASA. The author wishes to thank Thomas R. Costello, former engineer in the Boeing Lunar Orbiter project office, for making available a copy of Kloman's comment edition.
44. The portraits of Cliff Nelson and James Martin are derived from statements made to the author by several people associated with LOPO.
45. Kloman, "Organizational Framework: NASA and Langley Research Center," pp. 10-11.
46. Kloman, *Unmanned Space Project Management*, pp. 18-19 and 38.

Notes for Chapter 10

47. Taback interview, 13 Aug. 1991.
48. Norman L. Crabill interview, Hampton, Va., 28 Aug. 1991.
49. Kloman, "Organizational Framework," p. 9.
50. Taback interview, 13 Aug. 1991. See also the press release from News Bureau, the Boeing Co., Seattle, "Robert J. Helberg, Lunar Orbiter Program Manager," 27 Sept. 1965.
51. Kloman, *Unmanned Space Project Management*, p. 25.
52. Taback interview, 13 Aug. 1991.
53. The author wishes to thank LOPO member Norman L. Crabill for his careful explanation of the mission planning for Lunar Orbiter. Crabill interview, 28 Aug. 1991. For a lengthy written account of mission planning in relation to the design of the Lunar Orbiter spacecraft system, see Thomas T. Yamauchi, the Boeing Co., and Israel Taback, NASA Langley, "The Lunar Orbiter System," paper presented at the 6th International Symposium on Space Technology and Science, Tokyo, 1965, copy in the Langley Technical Library.
54. For the details about the evolution of the early mission plans for Lunar Orbiter, see Byers, *Destination Moon*, pp. 177–194.
55. Crabill interview, 28 Aug. 1991.
56. *Ibid.*
57. *Ibid.*
58. *Ibid.*
59. *Ibid.*
60. *Ibid.*; also see A. Thomas Young to Crabill, "Mission Reliability Analyses and Comparison for the BellComm Mission and TBC's S-110 Mission," A200-1B, LCF.
61. By the end of the project, Boeing earned nearly an extra \$2 million dollars in incentives. See Newport News (Va.) *Daily Press*, "Orbiter Incentive Award is \$1.9 Million," 28 Jan. 1967; "Lunar Orbiter Successes Earn Boeing \$1,811,611," 17 Nov. 1967; and "Lunar Success Pays Dividend for Boeing Co.," 18 Nov. 1967.
62. Crabill interview, 28 Aug. 1991.
63. See L. C. Rowan, "Orbiter Observations of the Lunar Surface," AAS (American Astronomical Society) Paper, 29 Dec. 1966; and L. R. Scherer and C. H. Nelson, "The Preliminary Results from Lunar Orbiter I," in *Spacecraft Systems*, vol. 1, International Astronautical Federation, 17th International Astronautical Congress, Madrid, Spain, 9–15 Oct. 1966.
64. See Byers, *Destination Moon*, pp. 241–243.
65. Taback interview, 13 Aug. 1991.
66. I have not been able to track down the exact source of the phrase, "the picture of the century," which came to be used generally to describe the historic first picture of the earth from deep space. A number of journalists used it in the weeks following the release of the photographs taken by *Lunar Orbiter I*. One might guess that a NASA public affairs officer invented it, but there is better reason to think that someone at Eastman Kodak coined the phrase. In January 1967, the company unveiled a rendition of the remarkable photograph on the huge Kodak Colorama inside Grand Central Station in New York City. The Kodak caption indeed called it "the picture of the century." This phrase, however, was also used to describe other Lunar Orbiter photographs. For example, Boeing and NASA Langley used it in "The Lunar Orbiter/A Radio-Controlled Camera," a brochure

published in 1968 (copy in LHA, Ames Collection, box 6), not to caption the earth shot, but to dramatize a stereoscopic picture of the Copernicus crater (see p. 350 of this book). Veterans of the Lunar Orbiter project team at Langley remember the earth shot as “the *real* picture of the century,” however, partly because they know the story of how it almost did not get taken. See Langley *Researcher News*, “Reliving a Moment in History,” 6 Sept. 1991, p. 5.

67. See Lunar Orbiter Photo Data Screening Group, “Preliminary Geological Evaluation and Apollo Landing Analysis of Areas Photographed by Lunar Orbiter II,” LWP-363, Mar. 1967, copy in Milton Ames Collection, LHA.
68. Byers, *Destination Moon*, pp. 243–244.
69. Crabill interview, 28 Aug. 1991.
70. Collins, *Liftoff*, p. 8.
71. Kloman, *Unmanned Space Project Management*, p. 7.
72. *Ibid.*, p. 33.
73. *Ibid.*, p. 22.
74. Crabill interview, 28 Aug. 1991.

Chapter 11

In the Service of Apollo

1. President John F. Kennedy, quoted in John M. Logsdon, *The Decision to Go to the Moon: Project Apollo and the National Interest* (Chicago: University of Chicago Press, 1976), p. 128.
2. As one might imagine, the literature on the Apollo lunar landing program is extensive, involving much more than just historical treatments. This diverse literature will be cited where most appropriate. For the details of the involvement of the various NASA centers in the Apollo program, the only adequate sources are in the official NASA History Series: Charles D. Benson and William Barnaby Faherty, *Moonport: A History of Apollo Launch Facilities and Operations*, NASA SP-4204 (Washington, 1978); Courtney G. Brooks, James M. Grimwood, and Loyd S. Swenson, Jr., *Chariots for Apollo: A History of Manned Lunar Spacecraft*, NASA SP-4205 (Washington, 1979); Roger E. Bilstein, *Stages to Saturn: A Technological History of the Apollo/Saturn Launch Vehicles*, NASA SP-4206 (Washington, 1980); Arnold Levine, *Managing NASA in the Apollo Era*, NASA SP-4102 (Washington, 1982); W. David Compton, *Where No Man Has Gone Before: A History of Apollo Lunar Exploration Missions*, NASA SP-4214 (Washington, 1989); and Sylvia Doughty Fries, *NASA Engineers and the Age of Apollo*, NASA SP-4104 (Washington, 1992). For more complete pictures of the roles of Houston and Huntsville in the Apollo program, readers should see two new NASA-sponsored books on the histories of these key NASA facilities: Henry C. Dethloff, *Suddenly, Tomorrow Came . . . : A History of the Johnson Space Center*, NASA SP-4307 (Lyndon B. Johnson Space Center, Tex., 1993), and Andrew Dunar and Stephen Waring, *History of Marshall Spaceflight Center* (forthcoming in the NASA History Series).
3. Laurence K. Loftin, Jr., interview with author, Newport News, Va., 8 July 1990.
4. Axel T. Mattson interview with author, Hampton, Va., 21 July 1989; only notes exist for this interview.

Notes for Chapter 11

5. In the LHA is a notebook labeled "Research Organization Changes/Announcements," which contains a chronological listing of all the major changes in the Langley organization from 1943 to the present. At one time this book was kept by the Langley staff office; for the past several years, it has been updated by the Langley historical programs monitor, Richard T. Layman. The entry for 28 Mar. 1962 reads: "Axel T. Mattson appointed Research Assistant for Manned Spacecraft Projects reporting to Associate Director—relieved of duties as Assistant Chief of Full-Scale Research Division."
6. "Mattson Named to New Position," *Langley Air Scoop*, 6 Apr. 1962, p. 1.
7. Mattson interview, 21 July 1989, and Mattson interview, Hampton, Va., 14 Aug. 1989, transcript, pp. 52–53, OHC, LHA. There is a recording and transcript for the latter interview only.
8. Mattson interview, 14 Aug. 1989, pp. 53–54.
9. *Ibid.*, pp. 54–55.
10. *Ibid.*, p. 76.
11. *Ibid.*, pp. 55–56.
12. *Ibid.*, pp. 56–58.
13. Mattson interview, 21 July 1989.
14. None of the published histories on Apollo have much to say about the impact studies conducted by North American in Downey. However, numerous technical reports have been written on this work and can be found in NASA technical libraries at Houston and elsewhere. In the LCF, code "Apollo Project," I have found numerous letters and memos concerning such studies. Several references to this R&D aspect of Apollo are made in the following excellent chronologies: Ivan D. Ertel and Mary Louise Morse, *The Apollo Spacecraft: A Chronology*, vol. 1, *Through November 7, 1962*, NASA SP-4009 (Washington, 1969); Mary Louise Morse and Jean Kernahan Bays, *The Apollo Spacecraft: A Chronology*, vol. 2, *November 8, 1962–September 30, 1964*, NASA SP-4009 (Washington, 1973); and Courtney G. Brooks and Ivan D. Ertel, *The Apollo Spacecraft: A Chronology*, vol. 3, *October 1, 1964–January 20, 1966*, NASA SP-4009 (Washington, 1973).
See also the transcript of my 14 Aug. 1989 interview with Axel Mattson for a rather complete personal account of North American's (and Langley's) work on the impact dynamics of the Apollo capsule.
15. Mattson interview, 14 Aug. 1989, p. 50.
16. *Ibid.*, pp. 51–54; also Sandy M. Stubbs's telephone interview with author, 29 June 1993. Several memos pertaining to Stubbs's work on the return landing characteristics of the Apollo spacecraft are in the LCF, "Apollo Project." There is a microfiche copy of this entire file in the LHA.
17. Mattson interview, 14 Aug. 1989, pp. 57–58.
18. *Ibid.*, p. 55.
19. *Ibid.*, p. 56.
20. Mattson interview, 14 Aug. 1989, pp. 56–58. See Sandy M. Stubbs, aerospace engineer, Structures Research Division, to Langley associate director, "Transmittal of information on a water pressure landing investigation of a 1/4-scale model of the Apollo spacecraft," 12 Oct. 1964, Apollo project files (microfiche), LHA. For Stubbs's work on Apollo's landing impact characteristics, see "Landing Characteristics of the Apollo Spacecraft

With Deployed-Heat-Shield Impact Attenuation Systems," NASA TN D-3059, Jan. 1966; and "Dynamic Model Investigation of Water Pressures and Accelerations Encountered During Landings of the Apollo Spacecraft," NASA TN D-3980, Sept. 1967. These two published papers contain references to his earlier work.

21. Mattson's reports can be found in the Apollo project files (microfiche), LHA. The dates of the reports evaluated in this chap. were: 4 Dec. 1962, 3 Dec. 1963, 17 Nov. 1964, 30 Nov. 1965, 23 Mar. 1966, and 19 Feb. 1968.
22. For basic information on Project Fire, see Linda Neuman Ezell, *NASA Historical Data Book*, vol. 2, *Programs and Projects, 1958-1968*, NASA SP-4012 (Washington, 1988), pp. 448-451. The rocket lifting the Fire reentry payloads was an Atlas-Antares; this made Fire unique in that it was the only NASA project ever to utilize the configuration. Herbert A. Wilson served as Langley's project manager for Fire 1, David G. Stone for Fire 2. Under contract to Langley, the Chance Vought Corp. of LTV built the velocity package. Republic Aviation built the reentry vehicle.

For complete details on Langley's management of this program, see *Project Development Plan: Flight Reentry Research Project at Hypersonic Velocities, Project Fire* (Langley Station, Hampton, Va.: Project No. 714-00-00, Mar. 1964), copy in LHA. Also preserved in the LHA is a videotape of key moments in the project's history from 1963 to 1965.

For an excellent technical summary of the problems of "Reentry from Lunar Missions" by a leading Langley engineer, see John V. Becker's presentation for Administrator James E. Webb, 5 Aug. 1961, LHA. Another copy of this document, along with an entire collection of Becker's personal papers, is in the Archives for Aerospace Exploration at the library at Virginia Polytechnic Institute and State University in Blacksburg, Va., Becker's alma mater.

23. Arthur W. Vogeley, "Piloted Space-Flight Simulation at Langley Research Center," unpublished paper presented to the American Society of Mechanical Engineers, winter meeting, 27 Nov.-1 Dec. 1966, copy in file "Langley Contributions to Manned Space Flight," Milton Ames Collection, LHA. In this file are numerous items pertaining to Langley's development of aerospace simulators. For a more brief and less technical contemporary overview of Langley's simulation work in support of the lunar landing program, see the NASA Langley press release, "Crucial Lunar Mission Events Are Duplicated by Langley Simulators," 18 May 1964, copy in 1964 NASA Inspection materials, LHA.
24. On Project Gemini, see Barton C. Hacker and James M. Grimwood, *On the Shoulders of Titans: A History of Project Gemini*, NASA SP-4203 (Washington, 1977), which is one of the best books in the NASA History Series.
25. Michael Collins, *Liftoff: The Story of America's Adventure in Space* (New York: NASA/Grove Press, 1988), pp. 72-73.
26. All the basic information about these facilities is in Martin A. Weiner, "Résumé of Research Facilities at the Langley Research Center," July 1968, a copy of which is preserved in the LHA. Weiner, an employee in Langley's Research Models and Facilities Division, had the job of keeping this résumé updated from the mid-1960s into the 1970s.

Notes for Chapter 11

27. Arthur W. Vogeley interview with author, Hampton, Va., 19 July 1989; only notes exist for this interview. For the details about this simulator, see Vogeley's "Discussion of Existing and Planned Simulators for Space Research," unpublished paper given at the Conference on the Role of Simulation in Space Technology, Blacksburg, Va., 17–21 Aug. 1964, as well as Francis B. Smith, "S for Manned Space Research," unpublished paper presented at the 1966 IEEE International Convention, 21–25 Mar. 1966, New York City. Copies of both are in the folder "Langley's Contributions to Manned Space Flight," Milton Ames Collection, LHA. For various documents, reports, references, newspaper articles, and other clippings relevant to this simulator, see the folder labeled "Rendezvous and Docking Simulator," LHA.
28. Quoted in Allan C. Hanrahan, "Rendezvous and Docking Maneuvers: Critical to Apollo Flight Plan," *Langley Researcher News*, 30 June 1989, p. 5.
29. Quoted in Matthew Paust, "Brainstorms Led to Practice's Realism," *Newport News (Va.) Daily Press*, 20 July 1989, p. A6.
30. W. Hewitt Phillips interview with author, Hampton, Va., 27 July 1989; this interview was not taped, but the author took notes. Numerous documents and newspaper clippings are in a folder labeled "Lunar Landing Facility and Apollo," LHA.
31. Neil A. Armstrong, *Wingless on Luna* (New York: The Wings Club, 1988), pp. 8–9. This book was produced from the Wings Club's 25th General Harold R. Harris "Sight" Lecture given by Armstrong at the Grand Hyatt Hotel, New York City, 18 May 1988.
32. Richard P. Hallion, *On the Frontier: Flight Research at Dryden, 1946–1981*, NASA SP-4303 (Washington, 1984), p. 146.
33. Mattson interview, 21 July 1989; see also Armstrong, *Wingless on Luna*, pp. 6–11.
34. Vogeley interview, 19 July 1989. According to an official NASA statement from May 1964, LOLA was not built as a training device for astronauts but as "a research tool with which NASA scientists can establish a fundamental understanding in the laboratory of the problems associated with the complex task of approaching the Moon and preparing for a landing on its surface." See Lee Dickinson, Langley Public Affairs Office, to Mr. Ken Allen, Beckman Instruments, Fullerton, Calif., 6 May 1964, Apollo project files, LHA.
35. Gilruth quoted in Michael Collins, *Liftoff*, p. 61.
36. On Rogallo and the idea of using his paraglider concept for Project Gemini, see Hacker and Grimwood, *On the Shoulders of Titans*, esp. pp. 18–20, 92–93, 98–100, 132–134, 147–148, and 170–172.
37. Francis M. Rogallo, "Parawings for Astronautics," luncheon speech presented at the Specialist Meeting on Space Rendezvous, Rescue and Recovery, co-sponsored by the American Astronautical Society and the Air Force Flight Test Center, Edwards AFB, Calif., 10–12 Sept. 1963, p. 1, copy in Ames Collection, box 6, LHA.
38. *Ibid.*, p. 2.
39. *Ibid.*
40. *Ibid.*, p. 3.
41. *Ibid.*, p. 4.
42. In the Milton Ames Collection in the LHA is a folder labeled "Flexible Wing" with numerous items relevant to the history of Rogallo's concept. These include several talks and papers that cover this period of the parawing's development delivered by Francis Rogallo to various professional organizations.

43. Francis Rogallo, "Flexible Wings," in *Astronautics and Aeronautics* (Aug. 1968): 54.
44. "NASA Honors Rogallos with Large Cash Award," *Langley Researcher*, 2 Aug. 1963, p. 1.
45. Rogallo, "Flexible Wings," pp. 52–53.
46. "Lifting bodies" are exactly what their names imply; that is, they are bodies that provide lift without the benefit of wings. In the 1950s, engineers in the NACA and the aerospace industry started thinking about such rounded half-cone designs, which resembled bathtubs or one-half of a baked potato, as a means of providing a minimum yet significant amount of aerodynamic lift for hypersonic gliders or other manned reentry vehicles. They thought that sufficient lift could be generated by such a shape to allow the pilot to maneuver the craft down from space through the atmosphere to a graceful gliding landing on a runway. In addition, the lift could be used to slow the spacecraft as it reentered at a high speed from orbital altitude. Lifting-body research continued through the 1960s to the present day. For an analysis of some of this NACA/NASA work, see Hallion, *On the Frontier*, pp. 147–172 and 339–346.
47. Robert R. Gilruth, STG, Langley Field, to NASA headquarters, Attn: George M. Low, "Development program on spacecraft landing systems," 6 July 1961, Apollo project files (microfiche), LHA.
48. Floyd L. Thompson to NASA, Code RAA, "Proposed Research Authorization entitled 'Free-Flight and Wind-Tunnel Tests of Guided Parachutes as Recovery Devices for the Apollo Type Reentry Vehicle,'" 30 Aug. 1961, Apollo project files (microfiche), LHA. On the testing of the Parasev at Edwards, see Hallion, *On the Frontier*, pp. 137–140.
49. Collins, *Liftoff*, pp. 82–83.
50. Hallion, *On the Frontier*, p. 138.
51. Collins, *Liftoff*, p. 82.
52. For an accurate narrative and analytical summary of the Apollo fire, see W. David Compton, *Where No Man Has Gone Before: A History of Apollo Lunar Exploration Missions*, pp. 91–112. For an inaccurate and sensational popular account of the tragedy, see *Murder on Pad 34* (New York: G. P. Putnam's Sons, 1968) by Eric Bergaust. There is definitely some blame and much responsibility to assign in the matter of the Apollo fire, but Bergaust's indictment is largely off the mark.
53. Robert C. Seamans, Jr., memorandum for the Apollo 204 Review Board, 28 Jan. 1967, Apollo project files (microfiche), LHA.
54. *Report of the Presidential Commission on the Space Shuttle Challenger Accident*, 5 vols. (Washington, 1987). For an excellent historical summary and analysis of the *Challenger* accident and the Rogers Commission investigation, see Collins, *Liftoff*, pp. 222–238.
55. Robert C. Seamans, Jr., interview with Walter Bonney, the Pentagon, Washington, D.C., 23 Feb. 1973, transcript, p. 19, OHC, LHA.
56. *Report of Apollo 204 Review Board to the Administrator, National Aeronautics and Space Administration*, 5 Apr. 1967, copy in the Langley Technical Library, CN-122577.
57. *Ibid.*, p. iii.
58. Collins, *Liftoff*, pp. 137–138.
59. John C. Houbolt quoted in James Schultz, *Winds of Change: Expanding the Frontiers of Flight: Langley Research Center's 75 Years of Accomplishment*, NP-130 (Washington, 1992), p. 98.

Chapter 12
The Cortright Synthesis

1. On Hans Mark's term as director of NASA Ames Research Center (1969–1977), see Elizabeth A. Muenger, *Searching the Horizon: A History of Ames Research Center, 1940–1976*, NASA SP-4304 (Washington, 1985), pp. 146–168. For insights into Mark's Machiavellian management philosophy, see Arnold Levine and Hans Mark, *The Management of Research Institutions: A Look at Government Laboratories*, NASA SP-481 (Washington, 1984).
2. "Dr. Thompson Receives Special Assignment," *Langley Researcher*, 8 Mar. 1968, p. 1. The *Langley Researcher* article was basically a reprint of a press release prepared at NASA headquarters.
3. Edgar M. Cortright interviews with author, Yorktown, Va., 18 July 1988 and 7 Aug. 1989. The author wishes to thank Mr. Cortright for the detailed and very candid interviews. Most of the insights used for this chapter come from the 18 July 1988 interview. The subsequent interview covered history pertinent to Cortright's work at NASA headquarters earlier in the 1960s.
4. Cortright interview, 18 July 1988, transcript, pp. 3–4 and 5–6, OHC, LHA.
5. *Ibid.*, pp. 3–4. On the feeling that NASA Langley was a little "sleepy" under Thompson's direction and needed some rejuvenation, also see pp. 9–10, 22, 48, and 68–70.
6. Cortright interview, 18 July 1988, pp. 5–6.
7. Quoted from "Cortright Assumes Duties as New Langley Director," *Langley Researcher*, 17 May 1968, p. 1.
8. Cortright interview, 18 July 1988, pp. 12–14.
9. *Ibid.*, pp. 6–7.
10. *Ibid.*, pp. 7 and 10.
11. *Ibid.*, pp. 14–15.
12. *Ibid.*, pp. 27–28.
13. *Ibid.*, pp. 69 and 19–20.
14. Langley Research Center Announcement No. 73-70, "Reorganization of Langley Research Center," 24 Sept. 1970, p. 1, copy in file labeled "Cortright Reorganization," LHA.
15. *Ibid.*
16. For an overview of the work of the Atmospheric Sciences Division, see "Atmospheric Sciences Division, Space Directorate, Langley Research Center," 10 Apr. 1992, unpublished, copy available in the Langley Public Affairs Office. For a published summary of Langley's achievements in the field of atmospheric sciences, see James Schultz, *Winds of Change: Expanding the Frontiers of Flight*, NASA NP-130 (Washington, 1992), pp. 119–121.
17. "Reorganization of Langley Research Center," p. 7. See also "Langley Announced Manager of Viking Project Office," *Langley Researcher*, 13 Dec. 1968, p. 1.
18. Cortright interview, 18 July 1988, pp. 45–48.
19. "Reorganization of Langley Research Center," p. 2.
20. Cortright interview, 18 July 1988, p. 16. See also "Dr. John E. Duberg Named Acting Associate Director," *Langley Researcher*, 19 Apr. 1968, p. 1. I conducted a long interview

- with John E. Duberg that covers the history of the Cortright reorganization and his ambivalent feelings about it. A transcript of this interview is located in the OHC, LHA.
21. Cortright interview, 18 July 1988, pp. 17–18.
 22. *Ibid.*, pp. 35 and 41.
 23. “Loftin Appointed to Special Assistant to Air Force,” *Langley Researcher*, 28 May 1971, p. 1. For Loftin’s critique of the Cortright reorganization, see interview with author, 5 Aug. 1989, Newport News, Va., transcript, pp. 72–87, OHC, LHA. For Cortright’s version, see Cortright interview, 18 July 1988, pp. 34–35.
 24. “R. E. Bower Named Langley Director for Aeronautics,” *Langley Researcher*, 9 July 1971, p. 1. Also see Cortright interview, 18 July 1988, p. 35.
 25. For additional thoughts from Cortright on his youth movement, see Cortright interview, 18 July 1988, pp. 19–20, 42–43, and 69.
 26. *Ibid.*, pp. 32–33. Langley in the 1960s and before did actually recruit at many universities outside of the South. It is true, however, that graduates of southern schools outnumbered the rest.
 27. *Ibid.*, p. 44. The phrase “sweat-shop conditions” is overly dramatic and implies a callousness toward manual labor on the part of Langley management that did not exist; Floyd Thompson and the old NACA crowd were extremely fond of the technical support staff and interacted with them much more regularly than Cortright and his successors ever did. Furthermore, into the late 1960s, several buildings at Langley that housed researchers were not air-conditioned, leaving them to suffer through the summer heat and humidity as well. Nevertheless, Cortright’s initiative should not be undervalued. His changes to the shops made a big difference to those who worked with their hands in the center’s various shops, plants, and hangars.
 28. Cortright interview, 18 July 1988, p. 61.
 29. *Ibid.*, p. 56. See also “Contract Awarded to Build Visitor Information Center,” *Langley Researcher*, 10 July 1970, p. 1.
 30. Cortright interview, 18 July 1988, p. 60.
 31. For the complete history of Project Viking and Langley’s management role, see Edward C. and Linda Neuman Ezell, *On Mars: Exploration of the Red Planet, 1958–1978*, NASA SP-4212 (Washington, 1984).
 32. Cortright interview, 18 July 1988, pp. 49–53. On NASTRAN, see Thomas G. Butler and Douglas Michel, *NASTRAN: A Summary of the Functions and Capabilities of the NASA Structural Analysis Computer System*, NASA SP-260 (Washington, 1971). ICASE has remained active from its inception under Cortright to the present. Its director in 1993 was Mohammed Y. Hussaini, Bldg. 1192, 18 West Taylor Street, NASA Langley Research Center.
 33. Cortright interview, 18 July 1988, pp. 51–52. For information on the early history of IPAD, see Robert E. Fulton, “National Meeting to Review IPAD Status and Goals,” in *Aeronautics and Astronautics* 18 (July/Aug. 1980): 49–52.
 34. Cortright interview, 18 July 1988, pp. 52–53.
 35. “Langley Buys Boeing Aircraft for Flight Research Program,” *Langley Researcher*, 30 Mar. 1973, p. 1. For all the details on the TCV program, see NASA Langley Research Center, *Terminal Configured Vehicle Program Plan* (Hampton, Va., 1 Dec. 1973). For a

Notes for Chapter 12

- complete history of Langley's use of the Boeing 737 airplane in the TCV/ATOPS program, see Lane E. Wallace, *Airborne Trailblazer: Two Decades with NASA Langley's 737 Flying Laboratory*, NASA SP-4216 (Washington, 1994).
36. Cortright interview, 18 July 1988, pp. 65–66.
 37. *Ibid.*, pp. 54–55. For an insightful history of how Langley was able to support supersonic research in the 1970s and 1980s in spite of the political and budgetary climate working against it, see F. Edward McLean, *Supersonic Cruise Technology*, NASA SP-472 (Washington, 1985), esp. pp. 101–170.
 38. Cortright interview, 18 July 1988, pp. 55–56. For information related to the origins of the NTF at Langley, see “Langley Tested for NTF Site,” *Langley Researcher*, 11 July 1975, p. 1, and “National Transonic Facility to be Dedicated,” *Langley Researcher*, 18 July 1977, p. 1. For an excellent technical and historical overview of the development of the NTF, see Donald D. Baals and William R. Corliss, *Wind Tunnels of NASA*, NASA SP-440 (Washington, 1981).
 39. Macon C. Ellis, “Rough Thoughts on Status and Future of Research at Langley,” p. 2, in file labeled “Thoughts on Status of Research at Langley,” Macon C. Ellis Collection, LHA.
 40. *Ibid.*
 41. *Ibid.*, pp. 1–2.
 42. “Some Thoughts on the Status of Research at Langley, 1969,” p. 1, in file labeled “Reasons for Accepting Assoc(iate) Ch(ief)—H(ypersonic) V(ehicles) D(ivision) in 1970/Case for Sp(ace) Scien(ces) Div(ision),” in Ellis Collection, LHA.
 43. Ellis notes to “So-called Minutes of 10/27/69 Mtg. of Sp. Sci. & Tech. Steer. Comm.,” 10 Nov. 1969, in Ellis Collection, LHA.
 44. “Some Hindsight Comments on Langley Management and Reorganizations of 1969–1974,” p. 1, in John V. Becker Collection, folder 22-1, Archives of Aerospace Exploration, Main Library, Virginia Polytechnic Institute and State University, Blacksburg, Va.
 45. *Ibid.*, pp. 1–2.
 46. *Ibid.*, p. 2.
 47. *Ibid.*
 48. See “Abstract of Remarks for Session 7, Airlie House Meeting, 3/13/70,” in folder 22-3, Archives of Aerospace Exploration, pp. 1–2, Virginia Polytechnic Institute and State University.
 49. *Ibid.*, p. 1.
 50. *Ibid.*, pp. 1–2.
 51. *Ibid.*, p. 2.
 52. *Ibid.*, pp. 2–3.
 53. *Ibid.*
 54. *Ibid.*, p. 3.
 55. See the marginal notes to Becker's “Abstract of Remarks for Session 7,” p. 3, for handwritten notes concerning the comments made by others to his presentation. Cortright's views on keeping Langley alive mirrored those of his counterpart at NASA Ames, Dr. Hans Mark. In his 1984 study of government laboratories (coauthored by Arnold Levine), Mark wrote: “There is a misconception that organizational self-perpetuation is somehow bad

- or even sinister. But this is not so. If it were, there would scarcely be a major corporation or nonprofit organization that could outlive its original reason for being and find other uses for its resources and experience" (*The Management of Research Institutions*, p. 82). The only way for a government laboratory to survive hard times, Mark argued, was for its management to be boldly entrepreneurial. In summary, this meant carving out a unique research area or "area of emphasis," attracting new programs to it, playing hardball bureaucratic politics, and generally doing whatever was necessary to cultivate powerful clients, sponsors, and constituencies. In contrast to this Machiavellian approach, Becker's view was not that Langley had totally achieved the objective for which it was first organized, or ever could, and thus could be put to death, but that it should live on to do what it was set up to do and, in fact, did the best. For him, it was a quality of life issue, so to speak. It made no sense to keep Langley breathing artificially for just any purpose; the country needed Langley to survive for basic applied research.
56. Kenneth Scheibel, "Future Operation of LRC Assured," Newport News (Va.) *Daily Press*, 17 Aug. 1969.
 57. Routing slip, J. V. Becker to Mr. Cortright, 19 Aug. 1969, pp. 1–2, copy in folder 22-1, Becker Collection, Archives of Aerospace Exploration, Virginia Polytechnic Institute and State University.
 58. *Ibid.*; Cortright wrote his reply on top of Becker's memorandum with a thick black pen, Archives of Aerospace Exploration, Virginia Polytechnic and State University.

Epilogue

1. The Apollo program cost a total of \$25 billion—\$21 billion on the first lunar landing. In contrast, in fiscal year 1961, the U.S. government spent a total of only \$98 billion. In 1961 the entire NASA budget was still less than \$1 billion; by 1964 it reached over \$5 billion and stayed at that level for the next four years. For data on the funding history of the Apollo program, see Linda Neuman Ezell, *NASA Historical Data Book*, vol. 2, *Programs and Projects, 1958–1968*, NASA SP-4012 (Washington, 1988), pp. 128–132, and Ezell, *NASA Historical Data Book*, vol. 3, *Programs and Projects, 1969–1978*, NASA SP-4012 (Washington, 1988), pp. 71–63.
2. A vast historical literature exists that treats the remarkable developments in American history in the late 1960s and early 1970s. For contrasting contemporary insights into these turbulent years, see W. L. O'Neill, *Coming Apart: An Informal History of America in the 1960s* (Chicago: Quadrangle Books, 1971), and Morris Dickstein, *Gates of Eden: American Culture in the Sixties* (New York: Basic Books, 1977). For a more balanced treatment, I recommend T. Gitlin, *The Sixties: Years of Hope, Days of Rage* (Toronto and New York: Bantam Books, 1987). On public policy in the years of the waning spaceflight revolution, see A. J. Reichley, *Conservatives in an Age of Change: The Nixon and Ford Administrations* (Washington: Brookings Institution, 1981). On the policies of *détente*, see Raymond L. Garthoff, *Détente and Confrontation: American-Soviet Relations from Nixon to Reagan* (Washington: Brookings Institution, 1985).
3. Michael Collins, *Liftoff: The Story of America's Adventure in Space* (New York: Grove Press, 1988), p. 269.

Notes for Epilogue

4. For a thoughtful retrospective on the ambitions of 1969, both for and against the space program, read John Tierney's feature story, "Earthly Worries Supplant Euphoria of Moon Shots," *The New York Times*, 20 July 1994, sec. A, pp. 1 and 11.
5. Ibid. To revisit the days of the "counterculture," peruse Charles Reich, *The Greening of America: How the Youth Revolution Is Trying to Make America Livable* (New York: Random House, 1971). For a detailed account of the Nixon presidency during the year 1969, see Stephen E. Ambrose, *Nixon: The Triumph of a Politician, 1969–1972* (New York and London: Simon and Schuster, 1989), pp. 223–321.
6. Norman Mailer, *Of a Fire on the Moon* (New York: Signet, 1969), p. 337.
7. Marcus, Picasso, and Mumford quoted in Tierney, "Earthly Worries Supplant Euphoria of Moon Shots," p. 11.
8. Von Braun quoted in Tierney, "Earthly Worries Supplant Euphoria of Moon Shots," p. 11.
9. Howard McCurdy, *The Space Station Decision: Incremental Politics and Technological Choice* (Baltimore and London: Johns Hopkins University Press, 1990), pp. 25–26.
10. Memorandum from Peter Flanagan to Thomas O. Paine and Robert Mayo, 6 Jan. 1970, in NASA HQA; quoted in McCurdy, *The Space Station Decision*, p. 26.
11. Richard M. Nixon, memorandum for the Vice-President et al., 13 Feb. 1969, taken from Space Task Group, *The Post-Apollo Space Program: Directions for the Future*, report to the president (Washington, D.C.: Executive Office of the President, Sept. 1969).
12. McCurdy, *The Space Station Decision*, p. 23.
13. Richard M. Nixon, "The Future of the United States Space Program," *Weekly Compilation of Presidential Documents*, 7 Mar. 1970, p. 329.
14. McCurdy, *The Space Station Decision*, p. 27.
15. William David Compton and Charles D. Benson, *Living and Working in Space: A History of Skylab*, NASA SP-4208 (Washington, 1983), pp. 52–56.
16. Fletcher quoted in McCurdy, *The Space Station Decision*, p. 27.
17. McCurdy, *The Space Station Decision*, pp. 22–23.
18. "America's Future in Space," speech given by Daniel S. Goldin, NASA administrator, at "'The Eagle Has Landed' at Auburn: A 25-Year Retrospective on the First Lunar Landing," a symposium held at the Auburn University Hotel and Conference Center, Auburn University, Auburn, Ala., 27 Oct. 1994.
19. Walter A. McDougall, *The Heavens and the Earth: A Political History of the Space Age* (New York: Basic Books, 1985), p. 5.
20. Ibid., p. 459.
21. For an analysis of President Reagan's 1984 State of the Union address and its support of Space Station *Freedom*, see McCurdy, *The Space Station Decision*, pp. 177–196. On the history of SDI—or at least that part of the top-secret program that is open to scholars—see Donald R. Baucom, *The Origins of SDI, 1944–1983* (Lawrence: University of Kansas Press, 1992).
22. Howard McCurdy, "The Graying of Space," *Space World*, 12 Oct. 1988.
23. For an excellent profile of NASA Administrator Daniel S. Goldin's philosophy for "reinventing" NASA, see William J. Broad, "Scientist at Work: Daniel S. Goldin: Bold Remodeler of a Drifting Agency," *The New York Times*, 21 Dec. 1993, sec. B, pp. 5 and 8.

For NASA's "Vision, Missions, and Goals" under Administrator Goldin, see the "NASA Strategic Plan" of May 1994. A copy is available from any NASA public affairs office.

24. Quoted in H. J. P. Arnold's chapter, "The Shuttle: Tragedy and Recovery," in *Man in Space: An Illustrated History of Spaceflight* (New York: Smithmark, 1993), p. 159. For the complete findings and recommendations, see U.S. House of Representatives, *The Future of the U.S. Space Program. Hearings before the Subcommittee on Space Science and Applications of the Committee on Science, Space, and Technology*, 101st Cong., 2d sess., 23 July 1990.
25. Edgar M. Cortright quoted in James Schultz, *Winds of Change: Expanding the Frontiers of Flight: Langley Research Center's 75 Years of Accomplishment, 1917-1992*, NASA NP-130 (Washington, 1992), p. 111.
26. For a summary of Langley's wind-tunnel testing in support of the Shuttle's development, see Donald D. Baals and William R. Corliss, *Wind Tunnels of NASA*, NASA SP-440 (Washington, 1981), pp. 117-121. A. M. Whitnah and E. R. Hillje provide a detailed engineering report on Shuttle wind-tunnel testing in *Space Shuttle Wind Tunnel Testing Program Summary*, NASA RP-1125 (Washington, 1984). For a discussion of the development of the special tiles used to protect the Shuttle during reentry, see Paul Cooper and Paul F. Holloway, "The Shuttle Tile Story," *Astronautics & Aeronautics* 19 (Jan. 1981): 24-36. Cooper and Holloway were Langley researchers directly involved in the Shuttle tile program. In 1991, Holloway became the director of Langley Research Center, succeeding Richard H. Petersen. It is also worth noting that former Langley engineer Max Faget played a critical role at the NASA center in Houston in the conceptual design of the Space Shuttle. For an important article that looks at early plans for the Space Shuttle, see Faget's "Space Shuttle: A New Configuration," *Astronautics & Aeronautics* 8 (Jan. 1970): 52-61. Starting in June 1973, the journal *Spaceflight* began running a series of articles by David Baker on the design evolution of the Space Shuttle; the last in the series appeared in Mar. 1978.

Langley remained deeply involved with the STS program even after the maiden flight of *Columbia* in 1981. The center developed simulations to solve problems in the orbiter's flight control and guidance systems and conducted additional landing tests on tires and brake systems. After the *Challenger* accident in Jan. 1986, Langley pitched in by helping to redesign the solid rocket boosters and develop new crew emergency escape systems.

27. On the potential of the aerobrake in the mid-1980s, see Thomas O. Paine et al., *Pioneering the Space Frontier: The Report of the National Commission on Space* (Toronto and New York: Bantam Books, 1986), pp. 121-122. For a fascinating science-fiction account of the use of aerobraking to accomplish a Mars orbital insertion (or MOI) for humankind's first permanent colonizing of the Red Planet, I highly recommend Kim Stanley Robinson, *Red Mars* (New York: Bantam Spectra Books, 1993), pp. 70-91.
28. Several ambitious proposals, NASA and non-NASA, surfaced in the 1970s to continue lifting-body research, but they failed to rejuvenate the program. With the Shuttle well into its design phase by the mid-1970s, NASA could not afford to vigorously pursue what amounted to a rival technology. For an analytical look into the history of the lifting-body concept in the United States, see Richard P. Hallion, *On the Frontier: Flight Research at Dryden, 1946-1981*, NASA SP-4303 (Washington, 1984), pp. 161-172. See

Notes for Epilogue

also Stephan Wilkinson, "The Legacy of the Lifting Body," *Air & Space Smithsonian* 6 (Apr./May 1991): 62.

On ambitions for the HL-20 by the early 1990s, see Theodore A. Talay and Howard H. Stone, "The Personal Launch System—A Lifting Body Approach," a paper presented at the 42d Congress of the International Astronautical Federation, 5–11 Oct. 1991, Montreal, Canada. The IAF published this paper as IAF-91-202.

29. Donald P. Hearth and Albert E. Preyss, "Hypersonic Technology: Approach to an Expanded Program," *Astronautics & Aeronautics* (Dec. 1976): pp. 20–37. Hearth served as director of Langley Research Center from 1975 to 1985. On the hopes for the scramjet, see The National Commission on Space, Paine et al., *Pioneering the Space Frontier*, pp. 101–103. The technical literature on the scramjet is extensive, and much of it is classified. For summaries of Langley's work, see O. A. Buchanon, "Development and Fabrication of Structural Components for a Scramjet Engine" (Hampton, Va.: NASA Langley Research Center, 1990), microfiche; "Shock Tunnel Studies of Scramjet Phenomena" (Hampton, Va.: NASA Langley Research Center, 1988), microfiche; and Stanley W. Candebo, "Scramjet Test Bridges Hypersonic Efforts," *Aviation Week & Space Technology* 140 (28 Mar. 1994): 52-54. The Candebo article reports on planned tests of a large-scale ramjet/scramjet power plant in Langley's 8-Foot High-Temperature Tunnel that will allow NASP investigators to determine, for the first time, how scale effects have influenced the design calculations used in scramjet R&D.
30. On the status of NASP in early 1994, see Stanley W. Candebo, "Redirected NASP Program to Focus on Technology," *Aviation Week & Space Technology* 140 (10 Jan. 1994): 29. See also Candebo's story from the previous summer, "NASP Canceled, Program Redirected," *Aviation Week & Space Technology* 138 (14 June 1993): 32.
31. Baals and Corliss, *Wind Tunnels of NASA*, pp. 96 and 133–134. See also Keith F. Mordoff, "New, Wind Tunnel Improves Accuracy," *Aviation Week & Space Technology* 119 (19 Dec. 1983): 69.
32. For a popular treatment of the NTF's design features and promises for important new data, see "Mighty Wind Roars," *Popular Mechanics* 162 (Apr. 1985): 65. There is a rather vast technical literature on the NTF, mostly NASA reports, all of which are available in the Langley Technical Library. A history of the NTF would make a fascinating doctoral dissertation in contemporary technology.
33. Baals and Corliss, *Wind Tunnels of NASA*, p. 134.
34. Mark Di Vincenzo, "Heaven's Call Ever Present; NASA Langley to Continue Role in Space Program," Newport News-Hampton (Va.) *Daily Press*, 20 July 1994, sec. A, pp. 1–2.
35. On the ambitions for the Mission to Planet Earth, see Paine et al., *Pioneering the Space Frontier*, pp. 30–33.
36. Di Vincenzo, "Heaven's Call Ever Present," p. 1.

Index

- Abbott, Ira H., 19, 199, 251, 29*ill.*
ABL. *See* Allegheny Ballistics Laboratory.
Adamson, David, 129, 130, 142–143, 223
Administration Directorate, 404
Advanced Man in Space (AMIS) project, 272–274
Advanced Research Projects Agency (ARPA), 51, 52, 55
Advanced Transport Operating System (ATOPS), 415
Advisory Group for Aeronautical Research and Development (AGARD), 267
aerobrake, 435
Aeromet General Corporation, 200
aeronautics,
 decline at Langley, 96–102, 97*ill.*
 present-day at Langley, 438
 the shift to space, 17–22, 451
Aeronautics Directorate, 403, 404
Aero-Physics Division, 89, 127
Aero-Space Mechanics Division, 89–90
Agena, 370
Agena-Class Lunar Orbiter Project (ACLOPS), 327
Agnew's Space Task Group, 430
Aircraft Configuration Branch, 177
Aircraft Engine Research Laboratory, 7.
 See also Lewis Research Center.
Aircraft Manufacturers' Conferences, 7, 6*ill.*
air-density measurement, 156, 158–162, 166, 191
Air Force Scientific Advisory Board, 235, 236
Air Force Tactical Air Command, 60
Air Force, U.S., 20, 57, 165, 170, 199, 200, 214, 289, 327, 338, 453
Airlie House, 418, 422, 423, 424
Air Scoop, 11, 169
air traffic, improvement, 415
Aldrin, Edwin E., Jr., 355, 428
Alfven, Hannes, 123
Algol motor, 200, 207, 211
Allario, Frank, 151
Allegheny Ballistics Laboratory (ABL), X248, 184, 187, 200, 201, 184*ill.*
 X254, 201
 X259, 201
Allen, H. Julian, 53, 393
Altair motor, 201, 207
American Telephone and Telegraph (AT&T), 176, 194
Ames Aeronautical Laboratory, 7
Ames, Joseph S., 7, 8*ill.*
Ames Research Center, 7, 32, 232, 393
Ampère, André-Marie, 135
Analysis and Computation Division (ACD), 86, 111, 414
Antares motor, 201, 209
Apollo 11, 268, 346, 350, 391, 429, 495
Apollo 13, 238, 389
Apollo 204 fire, 373, 387–391, 455
Apollo Applications Program, 306–307
Apollo Configuration Control Board, 389
Apollo Extension System, 270, 305–306
Apollo Orbital Research Laboratory (AORL), 301
Apollo project, 77, 98, 100, 113, 141, 245, 253, 369, 370, 371, 423
 command module, 237, 362–366, 364*ill.*
 flight plan, 237
 funding, 358
 Langley contributions, 366–369, 368*ill.*
 See also simulation research and Apollo 204 fire.
 management of, 356
 mission modes. *See* lunar landing mission modes.
 reentry, 380–381, 385, 386
 scope of effort, 355
Apollo Spacecraft Program Office, 366

Spaceflight Revolution

- Apollo Technical Liaison Plan, 233
Applied Materials and Physics Division,
89, 91, 367, 422
arc-jet, 133
Armstrong, Neil A., 41, 268, 346, 350, 355,
378-379, 428, 392*ill.*
Army Ballistic Missile Agency (ABMA),
xxvii, 34, 42, 102
Army, U.S., 22
Arnold Engineering Development Center,
60, 133
Arnold, Henry, 7
astronauts, Mercury, 39-45, 77, 456
Atlas-Agena, 293, 313, 321, 344
Atlas-Centaur, 344
Atlas-Mercury vehicle, 47
Atlas rocket, 38, 46, 50, 53, 54, 59, 236,
367
atmospheric sciences, 404
atomic bomb, 113, 135, 147, 171
Atomic Energy Commission, 12, 132, 147,
289
AT&T, 176, 194
Augustine, Norman, 433
aurora borealis, 122, 145, 146
avionics, 415
A.V. Roe (AVRO), 248, 455
Back River, 45, 72, 94, 62*ill.*
Bainbridge, William Sims, xxx-xxxi
Barium Cloud Experiment, 142-147
Bay of Pigs, 249
Becker, John V., 19, 31, 89, 98, 116, 127,
132, 150, 151, 232, 420-425, 434,
128*ill.*
Bell aircraft,
P-59, 18*ill.*
X-1, 7, 202
X-14A, 379
Bell Communications (BellComm), 108,
325, 350
Bell Telephone Laboratories, 65, 163, 176,
178, 186, 259
Bendix Corporation, 65
Bennett, Willard H., 148
Berglund, Rene A., 281, 283, 295, 297,
278*ill.*
B-58, 20
Biermann, Ludwig, 143-144
Biggins, Virginia, 456
Big Joe, 46-47, 59, 77
Big Shot, 113, 193-194
Bikle, Paul F., 31
Billingsley, Henry E., 30
Bird, John D., 230, 232, 233, 242, 246, 257,
229*ill.*
Bisplinghoff, Raymond L., 97, 90*ill.*
black hole, 216
Boeing aircraft,
P-26A Peashooter, 6*ill.*
737-100, 415, 416*ill.*
757, 416
767, 416
Boeing Company, 294, 295-297, 302,
313-314, 327
Lunar Orbiter, 328-332, 334-336,
340-342, 344-346
Terminal Configured Vehicle and Avionics
program (TCVA), 415-416,
416*ill.*
Bomarc Missile program, 295, 327
Bond, Aleck C., 257
Bonney, Walter, 12, 31*ill.*
Borman, Frank, 387
Bostick, Winston H., 149
Bower, Robert, 411
Boyer, William J., 57, 65, 67, 324, 332
Braun, Wernher von. *See* von Braun,
Wernher.
Brayton cycle, 288
Brayton, George B., 288
Bressette, Walter E., 167, 169, 171,
174-175, 186, 191, 175*ill.*, 183*ill.*
Brewer, Gerald, 323
Brissendon, Rcy R., 371
British National Physical Laboratory, 17
Brockman, Philip, 134*ill.*
Brookings Institution, 10
Brooks, Overton, 285, 286
Brown, C. T., Jr., 202
Brown, Clinton E., 42, 86, 158, 222,
223-224, 228, 232, 233, 236-237,
241, 242, 246, 276, 320, 327, 88*ill.*,
227*ill.*
Brummer, Edmund A., 323
Buckley, Edmond C., 57, 68, 69
"Buck Rogers", 17

- budget,
 Langley, 423
 space program, 428
 Buglia, James J., 53
 Bulkeley, Rip, 447
 Bullpup missile, 210
 Bureau of the Budget, 10, 104
 Burgess, George K., *8ill.*
 Burlock, Joseph, 140
 Burns and Roe, 65
 Busemann, Adolf, 129–130, 135, 139, 276
 Bush, George, 433
 Bush, Vannevar, 7, *9ill.*
 Butler, Sherwood, 112, 325
 Butler, T. Melvin, 404, *90ill.*, *279ill.*,
 398ill.
 Cable News Network (CNN), 195
 Cambridge Research Center, 164
 Cape Canaveral, xxvii, xxix, 64, 66, 102,
 170, 179, 187, 188, 189, 293, 367
 Cape Kennedy, 356
 Carpathian mountains, *348ill.*
 Carpenter, Malcolm Scott, 40, 41, 42, 76,
 40ill.
 Case Institute of Technology, 11, 13
 Castor, 201
 Castro, Fidel, 249
 Centaur rocket, 236, 283, 313, 351
 Center Development Directorate, 404
 Central Intelligence Agency (CIA), 172,
 249
 centrifuge, 42, 45
 Centro Italiano Ricerche Aerospaziali, 217
 CF-105 Arrow, 455
 Chaffee, Roger B., 387, 455, *390ill.*
 Chamberlin, James, 235, 248, 257
 Champine, Robert A., 41
 Chance Vought Astronautics, 228, 276
 Chance Vought Corporation, 201, 203, 228,
 260
 F8U-3, 27
 Chapman, Sydney, 122
 Cherokee, 198
 CIA, 172, 249
 Clarke, Arthur C., 162–163, 175, 176, 194,
 195, 271
 Clear Lake, Texas, 74
 Clemmons, Dewey L., Jr., 387
 Clinton, Bill, 433
 cockpit development, 415
 Coffee, Claude W., Jr., 175
 cold war, xxviii, 83, 172, 427, 433
Colliers, 271–272, 381–383
 Collins, Michael, 370, 391, 428
 comets, 143, 144, 145
 command module (CM), 237, 362–366,
 364ill.
 committees on lunar exploration, table,
 225
 Communications Satellite Corporation
 (ComSatCorp), 194, 195, 200
 communications satellites (comsats), 480,
 481
 communications system, global, 189
 computers, 111, 413–416, *111ill.*
 Congress, 51, 430
 Apollo, 392
 appropriations, 437
 House Independent Offices Appropria-
 tions Committee, 74
 House Select Committee on Science and
 Astronautics, 176, 285
 House Space Committee, 74, 451
 NACA, 2, 9, 10, 23
 NASA confirmation hearings, 15
 personnel authorizations, 104, 106, 109
 space station, 306
 supersonic transport (SST), 101, 416
 contracting,
 for Langley services, 108–112
 Langley philosophy, 82–84
 Lunar Orbiter, 325–326, *331ill.*
 Manned Orbiting Research Laboratory
 (MORL), 294–302, 307
 Mercury, 59, 65
 Scout, 203–205, 212–215
 Convair aircraft, 93
 B-58 delta-winged bomber, 20
 SF2Y-1 Sea Dart, 93
 Convair Astronautics, 170
 Cooper, L. Gordon, Jr., 41, 42, 77, 194,
 517, *40ill.*
 Copernicus crater, *348ill.*
 Coriolis effects, 277, 290
 Corneliussen, Sarah and Steve, 109
 Cortright, Edgar M., Jr., 150, 335, 389,
 434, 451, *398ill.*, *399ill.*, *409ill.*

Spaceflight Revolution

- Cortright, Edgar M., Jr. (*continued*):
appointed Langley director, 393–397
critique of, 418–425
development of electronics, 413–418
Lunar Orbiter, 319, 320, 325, 326
1970 reorganization, 89, 90, 92, 152,
398–407, 421–422
public relations, 412–413
staff, 408–412
- Crabill, Norman L., 153–156, 181, 185,
189, 195–196, 324, 334, 338, 339,
340–341, 349, 351, 183*ill.*
- Cronkite, Walter, 377, 378*ill.*
- Crossfield, Scott A., 41
- Crowley, John W., 166, 176–177, 199
- Curtiss-Wright Corporation, 81
- Davies, Merton E., 328
- Dawson, John R., 302
- Deep Space Network, 328
- DeFrance, Smith J., 31, 36–37
- Department of Defense (DOD), 41, 200,
216, 255, 297–298, 301, 327, 328,
338, 437, 453
- détente*, 428
- D-558, 7
- diffusion inhibitor, 149
- Diggs, Charlie, 137*ill.*
- Discoverer, 28
- Dödgen, John A., 232
- Dolan, Thomas E., 228, 237, 260
- Donely, Philip, 89
- Donlan, Charles J., 19, 52, 63, 86, 458,
264*ill.*, 361*ill.*, 398*ill.*
- Langley appointments, 99–100, 394–395,
397, 409, 421
- Lunar Orbiter, 316, 317, 317*ill.*
- Manned Spacecraft Center, 358, 359,
360, 363, 365
- Mercury, 41
- NACA transition to NASA, 2
- 1959 inspection, 34
- rendezvous, 241, 255
- space station, 294–295, 305
- Space Task Group (STG), 56, 57–58, 73,
74, 75
- Doolittle, James H., 8, 12, 451
- Douglas aircraft,
D-558, 7
- Douglas Aircraft Company, 108, 178, 231,
294, 295–302
- Draley, Eugene C., 19, 89, 91, 118, 177,
223, 224, 327, 332, 367, 404, 408,
88*ill.*, 90*ill.*, 398*ill.*
- Dryden Flight Research Center, 7
- Dryden, Hugh L., 10, 31, 52, 70, 71, 75,
76, 384, 400, 451, 452, 11*ill.*
- appointment to NASA, 12
- Echo, 166, 176
- NACA appropriations, 23
- 1959 inspection, 30, 34
- Space Task Group, 73
- Duberg, John E., 91, 367, 408, 398*ill.*,
409*ill.*
- Durand, William F., 7, 8*ill.*
- Dynamic Loads Division, 89, 91, 93
- Dyna-Soar project, 20, 132, 200, 273, 327,
453, 96*ill.*
- Eagle*, 346, 350, 356, 495
- earth,
first deep space photo, 344–346,
506–507, ii*ill.*, 345*ill.*, 352*ill.*
- earth-orbit rendezvous (EOR). *See* lunar
landing mission modes.
- East Area, 45, 72, 94
- Eastman Kodak, 328, 342, 506
- Echo 1*, 188–191, 192, 193, 277
- Echo 1 Passive Communication Satellite
Project, 154
- Echo 2*, 189, 193–194
- Echo project, 278, 280, 321
- air-density measurement, 156, 158–162,
166, 191
- Beacon satellite, 170–176, 174*ill.*
- construction material, 160, 167–169
- container, 180, 181*ill.*
- design, 158–162
- folding the balloon, 187–188
- Goddard, 177–179
- inflation, 154, 160, 169, 180–184, 186,
155*ill.*, 182*ill.*, 183*ill.*
- initial test, 153–156
- management, 112–113
- mapping, 190
- micrometeorites, 188, 189
- 100-foot satelloon, 177–185
- proposal for, 164–166
- Sub-Satellite, 166–170, 168*ill.*, 171*ill.*

- Echo project (*continued*):
 Task Group, 177, 178, 181, 186, 187, 188, 195, 183*ill.*
 telecommunications, global system, 162–164
 tracking, 161
 yo-yo de-spin system, 184–185, 186
 Edwards Air Force Base (AFB), 7, 63.
See also Dryden Flight Research Center.
 Edwards, Howard B., 233
 Eggers, Alfred J., 53
 Eggleston, John M., 232, 233
 E. I. du Pont de Nemours & Co., 167, 292
 Eisenhower, Dwight D., xxvi, xxvii, 173, 3*ill.*
 administration, 198
 creation of NASA, 2, 12, 449
Echo 1, 188
 Mercury astronauts, 41
 NASA personnel, 104
 Electronics Directorate, 403, 404
 Ellis, Macon C., Jr., 116, 125, 126–129, 132, 140, 142, 150, 151, 152, 418–420, 422, 434, 129*ill.*
 engineer-in-charge, 10
 English, Roland D., 198, 202, 210, 211, 213–214, 216
 “Enos”, 41
 Environmental and Space Sciences Division, 404, 420, 422
 Erectable Torus Manned Space Laboratory, 277–281, 279*ill.*, 280*ill.*
 European Space Agency, 217
 European Space Research Organization (ESRO), 144, 146
 Evans, John S., 140
 Explorer, 123
Explorer 1, 173
Explorer 9, 191
Explorer 10, 125
Explorer 19, 191
Explorer 24, 191, 192*ill.*
Explorer 39, 191
 F8U-3, 27
 F-101A, 17
 F-104 Starfighter, 20
 F-111A, 100*ill.*
 F-111B, 100*ill.*
 Faget, Maxime, 52, 226, 387, 451, 458, 517
 Mattson, Axel T., 360
 Mercury capsule, 43, 47, 53–54, 44*ill.*
 rendezvous, 235, 236–237, 241, 242, 255, 260, 261–262
 Scout, 197
 Fairburn, Robert, 323
 Fechet, James E., 8*ill.*
 Federal Aviation Administration (FAA), 415
 Federal Ministry for Scientific Research, West Germany, 145
 Feix, Marc, 130, 131*ill.*
 Fields, Edison M., 37
 Fire project, 91, 112, 216, 321, 322, 332, 367–369, 367*ill.*
 Fleming Committee, 250
 Fleming, William A., 250
 Fletcher, James, 430
 Flexi-Kite, 381
 Flight Instrumentation Division, 91
 Flight Mechanics and Technology Division, 90, 98
 Flight Reentry Programs Office, 91
 Flight Research Center, Edwards Air Force Base, 232, 378–379, 385, 386
 flying boats, 94
 Foelsche, Trutz, 330
 France, 217
Friendship 7, 260
 Fuhrmeister, Paul F., 86, 91
 Full-Scale Research Division, 90, 93, 94, 98, 380
 Gagarin, Yuri, 249
 Gapcynski, John P., 230
 Gardner, William N., 294, 303–305, 308, 300*ill.*, 308*ill.*
 Garland, Benjamin J., 53
 Garrick, Isadore E., 89, 267
 Gas Dynamics Laboratory, 122, 126, 129
 Geer, E. Barton, 387
 Geggie, Jean, 24
 Gemini project, 232, 257, 293, 301, 369, 370, 371, 385
 reentry, 380–381, 385
 General Dynamics aircraft,
 F-111A, 100*ill.*
 F-111B, 100*ill.*
 General Dynamics Corporation, 305

Spaceflight Revolution

- General Electric (G.E.), 108, 176
General Mills, 181, 184
General Motors, 259
Geophysics and Astronomy Division, 193
Germany, 217
Gibbons, Howard, 155
Gilkey, John E., 37
Gillis, Clarence L., 177
Gilmore, William E., *8ill.*
Gilruth, Robert R., 19, 31, 37, 43, 50, 202, 222, 379, 451, *38ill.*, *79ill.*, *361ill.*
 Echo, 165
 lunar-orbit rendezvous, 248, 265
 Marshall Space Flight Center, 360, 366
 Mercury planning, 51–55
 rendezvous, 242–245, 257, 260, 261, 262, 263
 Space Task Group's move to Texas, 76–77, 80, *79ill.*
 Space Task Group staffing, 55–57, 59, 60–63, 65, 69, 72, 73–74
 Sputnik, 172
Girouard, Robert, 323
Glenn, Annie Castor, *46ill.*, *79ill.*
Glenn, John H., Jr., 40, 42, 43, 76, 77, 222, 260, *40ill.*, *45ill.*, *46ill.*, *79ill.*
Glennan, T. Keith, 31, 81, 118, 236, 452, *13ill.*, *14ill.*, *29ill.*, *31ill.*
 appointment to NASA, 11–15
 “Message to Employees”, 12–15
 NASA personnel, 104–106
 1959 inspection, 30
 Space Task Group, 55
global telecommunication system, 175–177
Goddard Space Flight Center, 65, 194, 232, 395
 Echo, 177–179
 1959 inspection, 32, 34–37, *36ill.*
 Scout, 217
 Space Task Group, 72–74
Goett Committee, 226, 232, 272–274
Goett, Harry J., 31, 74, 179, 226
Gold, Thomas, 311
Goldin, Daniel, 433, 438
Golovin Committee, 255–257
Golovin, Nicholas E., 255
Goodyear Aerospace Corporation, 191
Goodyear Aircraft Corporation, 276, 277, 278, 285, 385
Graham, John B., 323, 324
Graves, G. Barry, Jr., 66, 67, *67ill.*
gravity, artificial, 281, 295, 297
Green, Milt, 203, 215
Griffith, Leigh M., 394
Grissom, Virgil I., 42, 222, 385, 387, 455, *40ill.*, *390ill.*
Grosse, Aristid V., 140
Group 1, 86, 91, 367, 369
Group 2, 86, 89, 367
Group 3, 86, 89, 367
G. T. Schjeldahl Company, 184, 187
Guggenheim, Harry F., 7
Guy-Lussac Promontory, *348ill.*
Hall, Edwin H., 138
Hall, Eldon W., 255
Hall, Harvey, 255
Hall, James R., 198, 202, 203, 205, 206–207, 209, 210, 212, 215, 219, *203ill.*
Hall, R. Cargill, 317–319
Hallion, Richard, 378–379, 385–386
“Ham”, 41
Hammack, Jerome, 37
Harbridge House, 118
Harrison, Albertis S., 77
Harvard College Observatory, 164
Hasel, Lowell E., 233
Hearth, Donald P., 417, 435, 437
Heaton Committee, 253, 255, 258
Heaton, Donald H., 253
heat shield, 53, 362, 369
Helberg, Robert J., 335, 340, 342, 344, 345, 351
Heldenfels, Richard R., 89, 233, 414
Heos 1, 146
Hercules Powder Company, 201
Hess, Robert V., 129, 131, 138, 139–140, 144, 151, *139ill.*
Hewes, Donald, 373, 374, 375, 377, *361ill.*, *374ill.*
High-Speed Flight Station, 7. *See also* Dryden Flight Research Center.
High-Speed Hydrodynamics Tank, 93
Hilburn, Earl D., 81, 104, 106
Hill, Paul R., 223, 233, 275, 277, 294, *275ill.*
HL-20, 435

- Hodge, John D., 37, 455
 Hoffer, Eric, xxix
 Holloway, 517
 Holmes, Brainerd, 258–259, 260, 263
 Honest John, 198
 Hook, W. Ray, 307
 Hoover, Herbert, 23
 Horrocks, Edith R., 202
 Horton, Elmer A., 37
 Houbolt, John C., 86, 222, 224, 230–231, 275, 356, 361–362, 391–392, 495–496, 244*ill.*, 247*ill.*, 266*ill.*
 letters to Robert Seamans, 249–251, 258–260
 lunar landing mode decision, 262–263, 265–268
 lunar-orbit rendezvous (LOR), 233–237, 238, 239–247, 252, 253–255, 257
 rendezvous committees, 231–233
 Hubbard, Harvey, 17
 Huber, Paul W., 129, 140, 152, 131*ill.*
 Hughes Aircraft Company, 194, 319, 327, 328, 330, 331, 335
 Hunsaker, Jerome C., 7, 9
 Huss, Carl R., 37, 57
 Hydrodynamics Division, 60, 93
 Hypersonic Ramjet Experiment, 112
 hypersonics, 158, 432, 435–436. *See also*
 Dyna-Soar project.
 boost glider, xxviii, 20, 54, 273
 tunnels, 133
 Hypersonic Vehicles Division, 420
 ICBM. *See* intercontinental ballistic missiles.
 incinerator, Hampton, 413
 Inspection, 1959, 51, 52
 exhibits, 27–28, 32–33, 35–38, 39–40, 42, 46–47, 126, 135, 29*ill.*, 31*ill.*, 32*ill.*, 36*ill.*
 guests, 31–32
 planning, 30, 33–37
 space station, 274
 Space Task Group, 37–38, 40–45
 Inspections, NACA, 28–30, 33–37
 Institute for Computer Applications in Science and Engineering (ICASE), 414
 Institute of Aeronautical Sciences (IAS), 383, 94
 Instrument Research Division (IRD), 86, 91
 Integrated Program for Aerospace-Vehicle Design (IPAD), 414–415
 Integrative Life Support System (ILSS), 305, 304*ill.*
 intercontinental ballistic missiles (ICBM), 132, 140, 200
 International Business Machines (IBM) Corporation, 65
 International Geophysical Year (IGY), 157, 163, 198
 International Telecommunications Satellite Consortium (Intelsat), 195
 inventor's award, 384, 495
 ion rockets, 132, 150
 Italy, 217
 Jacobs, Eastman N., 149
 Jacobs, Ken, 203, 214
 Jaffe, Leonard, 177, 178
 Jalufka, Nelson, 148
 James, Robert, 185
 Jastrow, Robert, 224
 Javelin rocket, 145
Jet Propulsion, 163
 Jet Propulsion Laboratory (JPL), 178, 224, 232, 255, 312–313, 315, 316, 319, 321, 334, 335, 351
 1959 inspection, 32, 34, 35–37
 Johnson, Caldwell,
 lunar-orbit rendezvous, 235
 NACA, 22–23, 24
 Space Task Group, 52, 53, 75, 458
 Johnson, E. Townsend, Jr., 411
 Johnson, Lyndon B., 10, 15, 74, 172, 249
 Johnson, Roy, 51, 55
 Jones, Robert T., 139
Journal of the American Rocket Society, 163
 Juno II, 173
 Jupiter C, xxvi, xxvii, 173, 198, 199
 Jupiter Senior, 198, 200
 Kantrowitz, Arthur, 149
 Karth, Joseph E., 286
 Katzoff, Samuel, 224, 327
 Kavanau, Lawrence L., 255
 Kennedy, John F.,
 assassination, 194

Spaceflight Revolution

- Kennedy, John F. (*continued*):
 lunar landing commitment, xxviii, xxix,
 77, 106, 221–222, 249, 286, 355, 427,
 428
 lunar-orbit rendezvous, 265
 management of NASA, 106
 New Frontier, 83
Kennedy Space Center, 102, 356, 389
Kepler crater, 318*ill.*
Kilgore, Edwin, 169, 187–188, 183*ill.*
Killian, James R., Jr., 51, 193, 449
Kimpton, Lawrence, 118
King, Paul, 16*ill.*
Kinzler, Jack, 47, 57
Kistiakowsky, George, 51
Kloman, Erasmus H., 350–351
Kolle, Hermann, 265
Kondratyuk, Yuri, 227
Kotanchik, Joseph N., 363, 365–366
Kraft, Christopher C., Jr., 17, 63, 455
Krieger, Robert L., 32
Kubrick, Stanley, 271
Kuhn, Thomas S., xxx
Kurbjun, Max C., 232, 246, 257, 371
Kyle, Howard C., 57, 65
Land, Emory S., 8*ill.*
Landing Loads Track, 93
Langley,
 budget, 107–108
 competition among divisions, 91–93
 organization, 1962, 85–91, 87*ill.*
 policy of obscurantism, 91–93, 401–402
 public relations, 22–25, 412–425
 relationship with headquarters, 104–109,
 398–407
 reorganization, 1970, 393–394, 403–418,
 405*ill.*
 “shadow” and ad hoc groups, 85, 92
Langley Memorial Aeronautical Laboratory, 4
Langley Researcher, 396*ill.*, 410*ill.*
Langley, Samuel P., 4
Lansing, Donald, 17
Large Launch Vehicle Planning Group, 255
Large Orbiting Research Laboratory
 (LORL), 301
lasers, 138, 149, 151
Launch Operations Center, 102
Leiss, Abraham, 202
Levine, Arnold S., 118
Lewis Flight Propulsion Laboratory, 7, 13,
 395
Lewis, George W., 10, 23, 91, 401, 404,
 8*ill.*, 9*ill.*, 11*ill.*
Lewis Research Center, 7, 32, 202, 232,
 246, 261
Ley, Willy, 383
Lidar In-Space Technology (LITE), 438
Life magazine, 266*ill.*
life-support system, 287, 289–292, 297,
 302–305
lifting-body research, 435, 511, 517
Lina, Lindsay J., 245
Lindbergh, Charles A., 7, 38, 58, 91, 97,
 384, 6*ill.*
Ling-Temco-Vought (LTV), 112, 203–205,
 213, 214–215, 216, 217, 204*ill.*
Little Joe, 28, 47, 50, 59, 77, 48*ill.*, 49*ill.*
Lockheed aircraft,
 F-104 Starfighter, 20
Lockheed Missiles and Space Company,
 277, 327, 331
Loftin, Laurence K., Jr., 71, 89, 92, 99,
 116, 118, 226, 251, 252, 276, 367,
 414, 421, 422, 88*ill.*, 90*ill.*, 398*ill.*
 AMIS, 272–274
 Cortright reorganization, 409–411
 space station, 285–286
Los Alamos National Laboratory, 149
Love, Eugene S., 233, 275, 421
Low Committee, 243, 245
Low, George M., 226, 241, 243, 245,
 249, 250, 258–259, 262–263, 268,
 283–284, 389, 451, 259*ill.*, 409*ill.*
lunar excursion module (LEM), 230,
 237, 238, 242, 316–317, 373–375,
 377–378, 243*ill.*, 266*ill.*, 376*ill.*,
 377*ill.*
lunar exploration committees, table, 225
Lunar Exploration Working Group,
 223–224, 226
lunar landing mission modes,
 compared, 234–241, 255–257, 261–262,
 247*ill.*, 254*ill.*, 256*ill.*
 direct ascent, 237, 239–241, 242, 246,
 250, 255, 261–262

- lunar landing mission modes (*continued*):
 earth-orbit rendezvous (EOR), xxix,
 231–232, 235, 237, 239, 241, 246,
 247, 253, 255, 263
 lunar-orbit rendezvous (LOR), xxix,
 233–239, 241–247, 250, 252, 253,
 255, 257, 258, 259, 260–270, 356,
 361–362, 495–496
 lunar-surface rendezvous, 252, 255
 Lunar Landing Research Facility, 371,
 373–379, 375*ill.*, 376*ill.*, 377*ill.*,
 392*ill.*
 Lunar Landing Training Vehicle, 378–379
 Lunar Mission Steering Group, 232–233
 Lunar Orbit and Letdown Approach
 Simulator, 371, 379, 380*ill.*
 Lunar Orbiter, 112, 196, 295, 297, 356,
 400, 314*ill.*
 assignment to Langley, 319–321
 basic research vs. project objectives,
 315–319, 320
 budget, 313, 330
 camera, 324–325, 328–329, 333, 336, 342,
 329*ill.*
 concurrent development, 322
 contract, 325–332, 334–336, 340–342,
 344–346, 331*ill.*
 earth photos, 344–346, ii*ill.*, 345*ill.*,
 352*ill.*
 lunar gravity data, 346
 mission objective, 313, 315, 319, 346
 NASA headquarters, 335–336
 photographic targets, 336–342, 346–350,
 337*ill.*
 photometry data, 349–350
 project management, 350–353
 project start-up, 322–326
 solar radiation, 330–331, 348
 typical flight sequence, 340*ill.*
Lunar Orbiter I, 342, 344, 345, 346, 506,
 343*ill.*, 344*ill.*
Lunar Orbiter II, 346, 348
Lunar Orbiter III, 318, 346
Lunar Orbiter IV, 346
Lunar Orbiter V, 346, 347, 349, 352
 Lunar Orbiter Project Office (LOPO), 91,
 323–324, 328, 332–334
 lunar-orbit rendezvous (LOR). *See* lunar
 landing mission modes.
- lunar surface, 311–312, 316–317, 314*ill.*
 Carpathian Mountains, 348*ill.*
 Copernicus crater, 348*ill.*
 dark side, 347*ill.*
 Guy-Lussac Promontory, 348*ill.*
 Kepler crater, 318*ill.*
 landing dynamics test, 318*ill.*
 Sea of Tranquility, 346, 356, 428
 Tycho crater, 349*ill.*
 lunar vacation, 428
 Lundin, Bruce T., 202, 250
 Lundin Committee, 250–253, 255
 Lunik, 125
 Lunney, Glynn, 57, 64
 Lust, Riemar, 143–144
 Mace, William, 232
 Maggin, Bernard, 92, 245
 Maglieri, Domenic, 17
 Magnetic Compression Experiment, 148
 Magnetohydrodynamics Section, 129,
 147–149
 magnetoplasmdynamics (MPD),
 conferences, 130
 definition, 121–122
 early theories, 122–126
 Inspection 1959 exhibits, 126, 135
 wane of, 150–152
 Magnetoplasmdynamics (MPD) Branch,
 85, 191
 creation, 126
 dissolution, 150–152, 421
 facilities, 133–141
 goals, 132
 organization, 129–130
 staff, 129, 130–131
 Thompson, Floyd L., 126–127
 magnetosphere, 123–124, 142, 144, 145,
 146, 217
 Mailer, Norman, 429
 Main Committee, NACA, 7
 Malley, George, 387
 Manhattan Project, 113, 147, 149
 Man-In-Space-Soonest project (MISS), 57
 Manned Lunar Landing and Return
 (MALLAR), 228
 Manned Lunar Landing Involving Ren-
 dezvous (MALLIR), 247–248, 257,
 243*ill.*
 Manned Lunar Landing Task Group, 243

Spaceflight Revolution

- Manned Orbital Rendezvous and Docking (MORAD), 247–248, 257
- Manned Orbiting Research Laboratory (MORL), 91, 293–302, 307–308, 296*ill.*, 298*ill.*, 300*ill.*, 302*ill.*
contract bidding, 294–302, 307
lunar exploration, 299–300
Studies Office, 294, 297, 303, 308
- Manned Spacecraft Center, 102, 107, 261, 262, 263, 264, 316–317, 356
Mattson, Axel T., 357–366
- Manned Space Flight Management Council, 263, 265
- Manned Space Laboratory Research Group, 231–232, 233, 274–276, 289
- Marcus, Greil, 429
- Marine Corps, U.S., 210
- Mariner C, 328
- Mark, Hans, 393
- Mars, 132, 151, 306, 353, 383, 404, 408, 413, 423, 429, 432, 434, 151*ill.*, 407*ill.*
- Marshall Space Flight Center, 102, 108, 232, 233, 246, 252, 255, 263, 264–265, 303, 356, 394
- Martin aircraft,
YP6M-1 Seamaster, 93, 95
- Martin Company, 276, 327
- Martin, James V., 331, 332–333, 406, 333*ill.*
- Martin Marietta Corporation, 433
- Marvin, Charles F., 8*ill.*
- Massachusetts Institute of Technology (MIT), 108
Millstone Hill Radar Observatory, 170, 173
- Masursky, Harold, 339
- Mather, G. R., 149
- Mathews, Charles W., 52, 54, 63, 65, 263, 387
- Mattson, Axel T., 33–37, 107, 35*ill.*
lunar-orbit rendezvous, 263
Manned Spacecraft Center, 357–366, 379, 361*ill.*
Visitors' Center, 413
- Max Planck Institut, 143, 145, 146
- Mayer, John P., 57
- Maynard, Owen E., 235, 241, 262
- Mayo, Robert, 429
- Mayo, Wilbur L., 230
- McCauley, John F., 339
- McCurdy, Howard, 432–433
- McDonnell aircraft,
F-101A, 17
- McDonnell Aircraft Corporation, 45
- McDonnell Douglas, 307
- McDougall, Walter A., xxvii, 171, 431–432
- McHatton, Austin, 188
- McKinsey & Co., 118
- McNamara, Robert S., 273, 301
- Meintel, Alfred J., Jr., 371
- Mercury-Atlas 6, 76
- Mercury-Atlas 7, 76
- Mercury-Atlas 8, 77
- Mercury-Atlas 9, 77
- Mercury Mark II*, 385
- Mercury project,
astronauts, 39–45, 77, 456
capsule, 45, 46, 52, 53, 60, 247, 458
29*ill.*, 31*ill.*, 44*ill.*, 45*ill.*, 46*ill.*
See also Big Joe.
contract requirements, 59, 65
control center, 64, 66
early skepticism, 58–59
flight concept, 38, 51, 52–55, 39*ill.*
impact tests, 60, 65, 96, 362, 61*ill.*, 62*ill.*
Langley support of, 59–63, 65–66, 77
orbital flights, 76, 77
tracking range, 63–69, 68*ill.*
- Meyer, Andre, 53
- Michael, William H., Jr., 152, 223, 224, 226–230, 237, 246, 227*ill.*
- micrometeorites, 188, 189, 216, 278–280, 281
- microwave cavity resonance, 138
- Military Test Space Station (MTSS), 298
- Miller, James, 184*ill.*
- Millstone Hill Radar Observatory, 170, 173
- Minitrack Network, 65, 161
- Minzer, Raymond, 164, 165
- MIR, 307–308
- Mission Control, 63–64, 268, 356, 391
- Mitchell, Jesse L., 167, 170–171, 181, 193, 171*ill.*
- Moffett Field, 7. *See also* Ames Research Center.
- Moffett, William A., 7, 8*ill.*
- Moonball experiment, 316

- Moore, William M., 202
Morrison Planetarium, 172
Moulton, Forrest R., 223
Mrazek, William A., 234
Mueller, George E., 397, 337*ill.*
Mumford, Lewis, 429
Muroc Dry Lake, 202
Muroc Field, 7
Mutual Weapons Defense Program
(MWDP), 453
Mylar, 167
NACA, xxviii,
aeronautical research, 15–17
appropriations, 9, 10, 23
charter, 3–7
committee system, 7–10, 449, 8*ill.*
conferences. *See* Inspections, NACA.
creation of, 2
director of research, 10
headquarters, 400, 401
Lewis, 451
Nuts, 24, 80
public relations, 22–25
research management, 23–24
transition to NASA, 1–3, 14–15
young Turks, 11, 451
NACA Conference on High-Speed Aerody-
namics, 53
NASA,
after Apollo, 308, 392
creation of, xxviii, 1–2, 3, 10–11
First Anniversary Inspection. *See* In-
spection, 1959.
intercenter relationships, 35–37, 178–179,
194, 357
inventions and contributions board, 384,
495
logo, 438
NASA Flight Research Center, 32
NASA headquarters, 91, 92, 100, 108,
395–397
center management, 224, 319, 322,
400–401, 424
Lunar Orbiter, 335–336
personnel, 107
NASA/Industry Apollo Technical Confer-
ence, 233, 253
NASA Structural Analysis (NASTRAN),
414
National Academy of Public Administra-
tion, 336, 350
National Academy of Sciences, 130, 158
National Aeronautics and Space Act, 11,
14, 15, 16, 22
National Aeronautics and Space Council,
12
National Aero-Space Plane (NASP), 432,
436
National Orbiting Space Station (NOSS),
298
National Science Foundation, 12, 41
National Transonic Facility (NTF), 418,
436–437, 417*ill.*
NATO, 267, 453
Naugle, John E., 474
Naval Aviation Medical Acceleration
Laboratory, 42, 45
Naval Research Laboratory (NRL), 32,
34–37, 166, 169, 178, 395
Navy, U.S., 16, 95
Polaris, 198, 200
R6L biplane amphibian, 16
Transit system, 216
Nelson, Clifford H., 323, 324, 326, 332–334,
334–335, 342, 351, 323*ill.*, 333*ill.*,
345*ill.*, 398*ill.*
Netherlands, 217
Newcomb, John F., 324
Newell, Homer E., 144, 319, 325, 395, 401,
474
Newport News *Daily Press*, 74–75, 155
Nichols, Mark R., 90, 99, 231, 274, 275
Nicks, Oran W., 319, 320, 325, 326, 395,
408–409, 411, 345*ill.*
Nike-Cajun (CAN), 164
Nike-Deacon (DAN), 164
Nike-Tomahawk, 145
Nixon, Richard M., xxviii, xxix, 148, 151,
249, 306, 307, 429–431
North American aircraft, 283, 295, 297,
384, 385, 391
X-15, 20, 28, 32, 54, 98, 131, 158, 371,
435, 456, 21*ill.*, 32*ill.*
XB-70 Valkyrie, 17, 115
XLR-99, 32
North American Aviation, 281, 290, 362,
363, 365
North American Rockwell, 146, 307

Spaceflight Revolution

- North Atlantic Treaty Organization (NATO), 267, 453
- Nova rocket, 237, 239–241, 244, 246, 250, 252, 258, 261–262
- nuclear power, 288–289
- nuclear weapons, 200
- Oberth, Hermann, 223, 271
- oblique photography, 345
- O'Brien-Joyner, Kitty, 105*ill.*
- Oertel, Goetz K. H., 130, 148
- Office for Flight Projects, 91, 367
- Office of Advanced Research and Technology (OART), 94, 106, 322
- Office of Aeronautical and Space Research, 92
- Office of Engineering and Technical Services, 369
- Office of International Programs, 30
- Office of Launch Vehicle Programs, 202, 239, 255
- Office of Manned Space Flight, 301, 319, 325, 356, 397
- Office of Space Flight Development, 30, 55, 72, 178–179, 202
- Office of Space Flight Programs, 246, 251
- Office of Space Sciences, 177, 178, 315, 316, 317, 319, 320
- Office of Space Sciences and Applications (OSSA), 144, 146, 148, 322, 324, 325, 326, 327
- Olstad, Walter B., 150
- O'Neal, Robert L., 241
- One-Man Propulsion Research Apparatus, 371
- "One-O-Wonder", 17
- Operation Paperclip, 130
- Osborne, Robert S., 294, 303–305, 275*ill.*
- Ostrander, Donald R., 202, 251
- O'Sullivan, William J., Jr., 92, 156, 157–162, 163, 164–166, 169, 170–171, 176–177, 178, 180–181, 185, 186, 191, 192–193, 476–477, 157*ill.*, 174*ill.*, 175*ill.*, 183*ill.*
- P-26A Peashooter, 18*ill.*
- P-59, 6*ill.*
- Pageos, 193, 193*ill.*
- Pageos I*, 191–192
- Paine, Thomas O., 395, 424, 428, 429, 388*ill.*
- Pan American World Airways, 428
- panto-base airplane, 93
- Parasev, 385–387, 386*ill.*
- Parasev I*, 386
- parawing, 381–387, 382*ill.*
- Parawing Project Office, 387
- Parker, Eugene N., 125, 143
- Parkinson, John B., 93–94
- Passive Geodetic Earth-Orbiting Satellite (Pageos), 191
- Pearson, E. O., Jr., 245
- Pearson, Henry, 42
- penetrometer, 316–317
- penetrometer feasibility study group, 316
- Peninsula Chamber of Commerce (PCC), 461
- Pennington, Jack E., 371
- Perry, Tom, 211, 217
- personnel,
- agency ceilings, 104–106
 - congressional authorization, 109
 - distribution among NASA centers, 104, 106, 103*ill.*
 - growth at Langley, 102, 103*ill.*
 - NASA headquarters, 107
 - recruitment policy, 411–412
- Petersen, Richard H., 391, 517, 417*ill.*
- Phillips, W. Hewitt, 42, 232, 275, 373, 374*ill.*
- Picasso, Pablo, 429
- Pierce, John R., 163, 175, 176, 177, 178
- Piland, Robert O., 197, 234, 235
- Pilotless Aircraft Research Division (PARD), 56–57, 89, 115–116, 167, 197, 198, 205
- Pilotless Aircraft Research Station, 7. *See also* Wallops Station.
- Pioneer 4*, 172
- Pioneer 10*, 431
- plasma accelerators, 133–141
- Plasma Applications Section, 129, 140
- Plasma Physics Section, 129, 130, 151
- plasma sheath, 132–133
- Plott, Anna, 323
- Pope Paul VI, 217
- Porter, Richard W., 165, 166
- Powers, John A., 80, 78*ill.*
- President's Science Advisory Committee (PSAC), 51, 176, 449

- primate pilots, 41, 47
 Pritchard, E. Brian, 150
 Projection Planetarium, 371
 project work, 108–109, 112–119
 predominance of, 315–319, 320, 406–408, 418–420, 422–425, 434. *See also*
 research culture deterioration.
 public relations, 412–413
 Langley, 357
 NACA, 22–25
 Purser, Paul, 47, 52, 235, 360
 Queijo, Manuel J., 241
 Radio Attenuation Measurements (RAM),
 112, 141, 216
 radio blackout, 133, 140
 Radio Corporation of America (RCA),
 176, 178, 328–330
 radio-transmission attenuation, 140
 Rand Corporation, 231, 325, 328
 Ranger, 113, 312, 315–316, 317, 319, 332,
 504
 Reagan, Ronald, xxix, 219, 428, 429, 435
 Recant, Isadore G., 345*ill.*
 Redstone Arsenal, 34
 Redstone rockets, 50, 59
 Reduced Gravity Walking Simulator, 371,
 377
 reentry experiments, 132–141, 150, 216
 Reid, Henry J. E., 10, 36–37, 55, 58, 81,
 91, 96, 394, 409, 9*ill.*, 14*ill.*, 29*ill.*
 relativity theory, 216
 Relay 1, 194
 Relay 2, 194
 rendezvous,
 earth-orbit. *See* lunar landing mission
 modes.
 importance of, 230, 232, 233, 235, 248,
 249–250, 251, 253
 launch window, 231
 lunar-orbit. *See* lunar landing mission
 modes.
 Michael's parking orbit, 226–230
 simulators, 281–283
 space station, 286
 Rendezvous and Docking Simulator,
 371–373, 372*ill.*
 Republic Aviation, 98, 332
 Research Airplane Project (RAP), 17
 research culture deterioration, 59, 70–72,
 76, 116, 152, 315–319, 320, 406–408,
 418–420, 422–425, 434, 439
 research management, 23–24
 Research Steering Committee on Manned
 Space Flight, 226
 Resident Research Associates (RRAs), 130
 retreats, staff, 418, 422
 Reynolds Metals Company, 167–169
 Rickenbacker, Edward V., 7
 Roberts, Leonard, 224, 311
 Rogallo, Francis M., 380–384, 387, 382*ill.*
 Rogallo, Gertrude, 381, 384, 387, 382*ill.*
 Roosevelt, Franklin D., 23
 Rosen, Milton W., 255
 Ross, H. E., 227
 rotating hexagon, 273*ill.*
 Rotating Vehicle Simulator, 371
 Rowan, Lawrence, 339, 345*ill.*
 Royal Aircraft Establishment, 130
 R6L biplane amphibian, 16
 Rupp, George, 210
 Ryan Company, 384, 385
 Saint project, 235
 Salinger, Pierre, 249
 Salyuts, 307, 308
 “Sam”, 47
 San Marco, 217, 218*ill.*
 satellites,
 communication (comsats), 163, 175–177
 geosynchronous, 162–164
 global telecommunication network,
 194–196
 mapping, 189, 192, 216
 passive, 176
 passive vs. active, 163, 179, 190–191, 194
 weather monitoring, 173
 Saturn C-1, 252, 229*ill.*
 Saturn C-3, 252
 Saturn I, 293, 297
 Saturn rocket, 98, 236, 239, 245, 246, 249,
 263, 283, 286, 293, 297, 306, 307,
 356
 Saturn V, 237, 429
 Savage, Melvyn, 239
 Scherer, Lee R., 325, 326, 328, 345, 330*ill.*
 Schirra, Walter M., Jr., 40, 42, 77, 40*ill.*,
 78*ill.*
 Schnitzer, Emanuel, 277–278

Spaceflight Revolution

- Schult, Eugene D., 202, 210, 213, 215, 211*ill.*
- Schy, Albert A., 224
- science fiction, 162, 163
- Scopinski, Ted, 57
- Scout project, 28, 112, 144, 145, 236, 247, 283, 321, 322, 400, 406, 204*ill.*, 208*ill.*, 214*ill.*
- approval, 199–200
 - Blue Scout, 200, 209
 - contractors, 203–205, 212–215
 - cost, 217
 - Cub Scout, 205–206
 - design, 198, 200–202
 - failures, 210–214
 - Goddard, 217
 - Project Office, 91, 202–203, 219
 - recertification, 212, 214–216
 - tests, 206–209, 201*ill.*, 207*ill.*, 212*ill.*, 213*ill.*, 214*ill.*
- scramjets, 152, 436
- Seamans, Robert C., Jr., 235, 236, 239, 249–251, 253, 255, 258, 260, 262, 295, 327, 387, 388–389, 391
- Sea of Tranquility, 346, 356, 428
- Sergeant, 198, 201
- X248, 154
 - XM-33, 184
- service module (SM), 237
- 737-100, 415, 416*ill.*
- 757, 416
- 767, 416
- SF2Y-1 Sea Dart, 93
- Shea, Joseph F., 259–260, 262, 264, 366
- Shepard, Alan B., Jr., 40, 42, 222, 249, 40*ill.*
- Sherwood project, 113, 147
- shop conditions,
- Langley, 513
- Shortal, Joseph A., 89, 167, 176, 177
- Shotput, 113, 179, 184–187, 188, 184*ill.*
- Shotput 1*, 153–156, 160, 185–186
- Siegel, Gerald, 172
- Sikorsky aircraft,
- twin-float Amphibian, 94
- Silverstein, Abe, 30, 55, 72–74, 178–179, 202, 246, 251, 258, 395, 411, 451
- Silvertson, Wilford E., Jr., 233
- Simpkinson, Scott, 47
- simulation research, 369–371
- simulators,
- closed-loop analog, 43
 - Gemini and Apollo, 371–380
 - lunar gravity, 282*ill.*
 - rendezvous, 281–283
- Sinclair, A. Wythe, Jr., 275
- Skylab, 270–271, 306, 307, 308, 430
- Slayton, Donald K., 40, 42, 40*ill.*
- Smith, Francis B., 86, 91, 367
- Smith, Norman F., 37
- Smithsonian Astrophysical Laboratory, 164
- Society of Automotive Engineers, 232, 233
- solar corona, 147, 148
- solar cycle, 123
- solar flares, 125, 146, 148
- solar physics, 147
- solar power, 277, 288, 289
- solar wind, 125, 142, 143
- solid-fuel rockets, 198
- Soulé, Hartley A., 17, 22, 66, 86
- sound barrier, 41
- Source Evaluation Board, 326–329
- Soviet Union, 10, 157, 189, 198, 307–308, 433, 440
- Spaatz, Carl, 7
- Space Applications Branch, 85
- Space Base, 306–307
- Space Defense Initiative (SDI), 432
- Space Directorate, 403, 404, 422
- Space Exploration Program Council (SEPC), 238–241
- spaceflight revolution, xxx–xxxi, 355, 381, 393, 395, 400, 439–440
- changes at Langley, 418–420
 - present-day, 431–434, 439–440
- Space Mechanics Division (SMD), 369–380
- Space Physics Section, 129, 130, 142
- space program, NASA,
- budget, 428, 433
 - declining interest in, 428–429
 - present-day goals, 433–434
- space race, 76, 82, 83, 108, 202, 223, 269, 427–428
- space research,
- present-day at Langley, 437–438
- Space Sciences and Technology Steering Committee, 419–420

- Space Sciences Division, 152
 Space Sciences Steering Committee, 144
 Space Shuttle, xxviii, xxix, 54, 141, 158, 307, 421, 434–435, 517
Challenger, 219, 388, 389, 391, 432, 448, 517
Columbia, 517
 Nixon, Richard M., 430
 space sickness, 216
 space station, xxix, 189, 421. *See also*
 Manned Orbiting Research Laboratory (MORL).
 air lock, 281, 299*ill.*
 Apollo's influence, 292–293, 305
 Apollo X, 301
 artificial gravity, 281, 287, 295, 297
 budget constraints, 306
 competing concepts, 301, 306–307
 construction material, 291–292
 dynamic control, 280–281, 286–287
 early budgets, 283–285
 early concepts, 223, 226, 271–272
 early proposals, 277, 278*ill.*
 inflatable torus, 277–281, 292, 279*ill.*, 280*ill.*, 282*ill.*
 life-support system, 287, 289–292, 297, 302–305
 Nixon, Richard M., 430
 opposition to, 276
 power source, 287–289, 297
 rotating hexagon, 281–283, 292, 295, 297, 284*ill.*
 skipped step, 307–309
 testimony before congress, 285–286
 Space Station *Alpha*, 308, 435
 Space Station *Freedom*, 308, 432
 Space Station Research Group, 294
 Space Station Task Force, 309
 Space Systems Research Division, 421, 422
 Space Task Group (STG), 178, 202, 222, 321, 455
 facilities, 72
 Goddard, 72–75
 Hampton parade, 77–80, 78*ill.*, 79*ill.*
 lunar-orbit rendezvous, 234, 235, 236, 241–245
 move to Texas, 74, 76–80, 461
 1959 inspection, 37–38, 40–45
 promotions, 71
 Space Task Group (STG) (*continued*):
 rendezvous, 245, 246, 248, 255, 257, 260, 261–263
 staffing, 55–59, 60–62, 69, 72, 73–74
 Space Technologies Laboratories (STL), 321, 325, 326, 327, 328, 330, 331
 Space Transportation System (STS), 219, 307, 434, 517
 Space Vehicle Group, 167, 173, 177, 178
 Special Committee on Space and Astronautics, 10
Spirit of St. Louis, 384
 Spitzer, Lyman, Jr., 158
 Sputnik, 76, 97, 199, 381, 384, 439, 440
 crisis, xxvi–xxix, 10, 99, 156, 171–172, 369, 449–450
Sputnik 1, xxxi, 19, 171, 172, 249, 383, 447
Sputnik 2, xxvii, 249, 447
 Stack, John, 20, 22, 89, 98–100, 116, 135, 451, 453, 35*ill.*, 99*ill.*
 “Star Wars”, 432. *See also* Strategic Defense Initiative (SDI).
 State Department, 172
 Stevens Institute of Technology, 149
 Stokes, Charles S., 140
 Stone, Ralph W., Jr., 236, 241
 Stoney, William E., Jr., 197, 199, 200, 202, 210
 Strang, Charles F., 387
 Strategic Defense Initiative (SDI), 149
 Stratton, Samuel W., 8*ill.*
 Strauss, H. Kurt, 241
 Structures Directorate, 403, 404, 414
 Structures Research Division, 89, 91, 92
 Stubbs, Sandy M., 363, 365, 366
 Stuhlinger, Ernst, 394
 Sunflower Auxiliary Power Plant Project, 277
 Supersonic Commercial Air Transport (SCAT), 101*ill.*
 supersonic transport (SST), xxix, 20, 27, 98, 100, 101, 404, 415, 416–418
 Surveyor Lander, 319
 Surveyor Orbiter, 319
 Surveyor project, 113, 252, 312–313, 315, 327, 334, 335, 350–351
 Swallow aircraft, 20, 453, 21*ill.*
 sweptwing theory, 20, 139
 Swift, Calvin T., 140

Spaceflight Revolution

- Syncom 3*, 195
Systems Engineering and Operations
 Directorate, 404
Taback, Israel, 93, 323, 324, 328, 332, 334,
 336, 349, 323*ill.*
Tank No. 1, 45, 60, 94, 95*ill.*
Tank No. 2, 94, 95, 96*ill.*
Tant, Larry, 204
Taub, Will, 184*ill.*
Taylor, David W., 8*ill.*
Teague, Olin E., 74
technical report, 114, 116
telecommunications satellite (comsat),
 194–196
Telstar, 65
 Telstar 1, 194
 Telstar 2, 194
Temple University Research Institute,
 139–140
Terminal Configured Vehicle and Avionics
 (TCVA), 415–416
Theoretical Mechanics Division, 86, 223,
 369, 371
thermonuclear fusion, 132, 147–149, 150
Thibodaux, Joseph G., Jr., 197
Thiokol Company,
 Redstone Division, 201
Thom, Karlheinz, 130, 148
Thomas, Albert H., 74
Thompson, Floyd L., 16, 81–85, 86, 94,
 96, 104, 342, 345, 6*ill.*, 29*ill.*, 84*ill.*,
 90*ill.*, 264*ill.*, 279*ill.*, 337*ill.*, 345*ill.*,
 358*ill.*, 388*ill.*
 Apollo, 357, 360, 366
 Apollo 204 fire, 387–389
 associate director, 394–395
 Echo, 165, 167, 176
 Hampton community, 24
 Lunar Orbiter, 319–321, 323, 326, 333
 lunar-orbit rendezvous, 246
 magnetoplasmdynamics, 126–127
 management style, 91–93, 99–100, 421
 NACA charter, 4
 personnel, 106–107
 rendezvous, 232
 replacement of, 395, 397, 396*ill.*
 Scout, 202, 205
Thompson, Floyd L. (*continued*):
 space station, 274–276, 294
 Space Task Group, 55–56, 59–63, 65–66,
 69–72, 75, 76, 77, 80
Thompson-Ramo-Wooldridge (TRW), 108,
 277, 321
Thor-Able, 28, 199
Thor-Agena, 191
Thor-Delta, 154, 177, 184, 187, 188
Tidewater Virginia, 4, 5*ill.*
tiger team, 214–215
Time-Life, 39, 456
Titan, 259, 293
Tolson, Robert H., 230
Tracking and Ground Instrumentation
 Unit (TAGIU), 66–69
Trout, Otto, 303*ill.*
Truscott, Starr, 94
Tsiolkovskiĭ, Konstantin, 223, 226, 271
Tycho crater, 349*ill.*
UFOs, 146, 171
United Kingdom, 217
Upper Atmosphere Rocket Research Panel,
 156–157, 161, 164, 165
Urey, Harold C., 224, 315
U.S. Army Map Service, 192
U.S. Coastal and Geodetic Survey, 192
U.S. Geological Survey, 338, 339
U.S. National Committee/International
 Geophysical Year (USNC/IGY),
 technical panel on rocketry, 164
 technical panel on the earth satellite
 projects, 164, 165, 166, 172–173
U.S. Post Office Department, 192
USS *Hornet*, 429
U-2 “spy plane”, 20
Van Allen, James, 123, 158
Van Allen radiation belts, 123–125, 145,
 173, 216, 331, 124*ill.*
Van Cleve, Jon, 204
Vandenberg Air Force Base (AFB), 210,
 213, 215, 216
Vandenberg, Hoyt, 7
Van Dolah, Robert W., 387
Vanguard 1, 173
Vanguard rocket, 166, 170, 173
Vanguard satellite, xxvii, 157–158, 164,
 170, 198
Variable-Density Tunnel (VDT), 305, 436

- variable wing sweep, 100
 Vavra, Paul H., 66
 Vega, 32, 36
 Verne, Jules, 226
 Vertol 76, 27
 VE-7, 16*ill.*
 Victory, John F., 12, 31, 34, 8*ill.*, 84*ill.*
 Vietnam War, 269, 305
 Viking Lander, 406*ill.*
Viking Lander 2, 407*ill.*
 Viking project, 70, 196, 353, 404–408, 413, 423, 431, 434
 Viking Project Office, 353, 404
 Viking rocket, xxvii, 198
 Virginia Air and Space Center, 413
 Virtual Image Rendezvous Simulator, 371
 Visitors' Center, 412–413
 Voas, Robert T., 42, 456
 Vogeley, Arthur W., 232, 245, 246, 257, 261, 369, 371, 373, 227*ill.*
 von Braun, Wernher, xxvi, 34, 50, 198, 223, 239, 246, 356, 383, 429, 494, 495, 264*ill.*
 rendezvous, 236, 241, 262, 263–265, 268
 space station, 271–272
 von Pirquet, Guido, 223, 271
 von Puttkamer, Jesco, 270
 “Voodoo”, 17. *See also* McDonnell aircraft.
Vostok 1, 241
 Vought aircraft,
 VE-7, 16*ill.*
 XF5U, 58
 Voyager, 431
 VTOL tests, 95
 V-2 Panel, 156–157, 474
 V-2 rockets, 28, 156, 157
 Walker, Joseph A., 41
 Waller, Marvin C., 371
 Wallops Station, 7, 27, 28, 47, 60, 89, 107, 144, 146, 153, 154, 179, 198, 201, 202, 203, 205, 207, 210, 211, 213, 215, 367, 383, 206*ill.*, 208*ill.*
 Walter Kidde and Company, 200
 Ward, Donald H., 322
 Water Immersion Simulator, 371
 Watson, William I., 323, 324
 Weapons System (WS)-110A, 115, 116, 276, 117*ill.*
 weather, controlling, 146
 Webb, James E., 81–82, 84–85, 92, 106, 118–119, 194, 249, 265, 315, 322, 331, 357, 397, 421, 84*ill.*, 279*ill.*, 331*ill.*, 358*ill.*
 West Area, 72
 Western Electric Company, 65, 69
 Whipple, Fred L., 164, 170, 172
 White, Edward H., 373, 387, 455
 White, George C., Jr., 387
 Wiesner, Jerome, 265
 Wilford, John Noble, xxvi, xxvii
 Williams, John J., 387
 Williams, Walter C., 63
 Wilson, Herbert A., Jr., 367, 420
 wind tunnels,
 Anechoic Antenna Test Facility, 416*ill.*
 Continuous-Flow Hypersonic Tunnel, 128*ill.*
 crossed-field plasma accelerator, 135–138
 cyanogen flame apparatus, 138–140, 141*ill.*
 8-Foot Transonic Tunnel, 302*ill.*
 Electro-Magnetic Hypersonic Accelerator Pilot Model Including Arc-Jet Ion Source, 133
 4-Foot Supersonic Pressure Tunnel, 383
 Full-Scale Tunnel, 74, 384, 6*ill.*, 18*ill.*, 61*ill.*, 95*ill.*, 386*ill.*
 Hall-current plasma accelerator, 137*ill.*
 hotshot, 133–134
 impulse, 133, 134
 linear Hall-current accelerator, 138
 MPD-arc plasma accelerator, 138, 134*ill.*
 one-megajoule theta-pinch, 147–148
 plasma-focus research facility, 148–149
 7 × 10-Foot High-Speed Tunnel, 21*ill.*, 61*ill.*, 117*ill.*
 shock tube, 134–135
 16-Foot Transonic Tunnel, 21*ill.*
 20-megawatt plasma accelerator, 135, 136*ill.*
 Unitary Plan Wind Tunnel, 62*ill.*, 101*ill.*
 Variable-Density Tunnel (VDT), 18*ill.*
 Wind Tunnel No. 1, 17
 Windler, Milton B., 37
Wireless World, 162
 Wolfe, Elmer J., 202
 women scientists, 105*ill.*

Spaceflight Revolution

- Wood, George P., 129, 131, 135, 138,
136*ill.*
- Working Group on Lunar and Planetary
Surfaces Exploration, 224
- World War I, 2, 4
- World War II, 7, 12, 24, 94, 113, 119, 130,
156, 369
- Wright, Orville, 7, 6*ill.*, 8*ill.*
- X-1, 7, 202
- X-14A, 379
- X-15, 20, 28, 32, 54, 98, 131, 132, 158, 371,
435, 456, 21*ill.*, 32*ill.*
- X-20, 20, 132, 200, 273, 327, 453, 96*ill.*
- X-30, 436
- XB-70 Valkyrie, 17, 115
- XF5U, 58
- XLR-99, 32
- X-rays, 217
- Yeager, Charles E., 41
- York, Herbert, 51, 55
- Young, Tom, 339, 341, 349
- YP6M-1 Seamaster, 93, 95
- Zimmerman, Charles H., 52, 58, 59, 158,
458
- Zond III*, 346

The Author

James R. Hansen is Alumni Associate Professor of History and chair of the Department of History at Auburn University in Auburn, Alabama. He is the author of three books as well as several book chapters, articles, and reviews in aerospace history and the history of technology. His books include: *Engineer in Charge: A History of the Langley Aeronautical Laboratory, 1917–1958*, which was published by NASA in 1987, and *From the Ground Up: The Autobiography of an Aeronautical Engineer*, co-authored by American aviation pioneer Fred E. Weick and published by the Smithsonian Institution Press in 1988. The latter book received the History Book Award of the American Institute of Aeronautics and Astronautics (AIAA).

Professor Hansen has received a number of citations for his historical scholarship, including the Robert H. Goddard Award from the National Space Club and distinctions of excellence from the Air Force Historical Foundation and the American Institute for Aeronautics and Astronautics. In 1986–1987 he gave historical talks around the country as an AIAA Distinguished Lecturer. He has served on a number of important advisory boards and panels, including the Research Advisory Board of the National Air and Space Museum, the Editorial Advisory Board of the Smithsonian Institution Press, the Board of Advisers for the Society for the History of Technology, and the Advisory Board for the Archives of Aerospace Exploration at Virginia Polytechnic Institute and State University. He is also a past vice-president of the board of directors of the Virginia Air and Space Center and Hampton Roads History Center in Hampton, Virginia.

At Auburn University, Dr. Hansen teaches courses on the history of flight, the history of science, space history, as well as a large auditorium class that surveys the history of technology from ancient times to the present—or, as he puts it, “from Australopithecus to Arthur Clarke.”

Hansen earned an A.B. degree, with high honors, from Indiana University (1974) and an M.A. (1976) and Ph.D. (1981) from The Ohio State University. He was born in Ft. Wayne, Indiana, on 12 June 1952. He is married to Margaret Anne Miller-Hansen and has two children, Nathaniel and Jennifer.

The NASA History Series

Reference Works, NASA SP-4000:

- Grimwood, James M. *Project Mercury: A Chronology* (NASA SP-4001, 1963).
- Grimwood, James M., and Hacker, Barton C., with Vorzimmer, Peter J. *Project Gemini Technology and Operations: A Chronology* (NASA SP-4002, 1969).
- Link, Mae Mills. *Space Medicine in Project Mercury* (NASA SP-4003, 1965).
- Astronautics and Aeronautics, 1963: Chronology of Science, Technology, and Policy* (NASA SP-4004, 1964).
- Astronautics and Aeronautics, 1964: Chronology of Science, Technology, and Policy* (NASA SP-4005, 1965).
- Astronautics and Aeronautics, 1965: Chronology of Science, Technology, and Policy* (NASA SP-4006, 1966).
- Astronautics and Aeronautics, 1966: Chronology of Science, Technology, and Policy* (NASA SP-4007, 1967).
- Astronautics and Aeronautics, 1967: Chronology of Science, Technology, and Policy* (NASA SP-4008, 1968).
- Ertel, Ivan D., and Morse, Mary Louise. *The Apollo Spacecraft: A Chronology, Volume I, Through November 7, 1962* (NASA SP-4009, 1969).
- Morse, Mary Louise, and Bays, Jean Kernahan. *The Apollo Spacecraft: A Chronology, Volume II, November 8, 1962–September 30, 1964* (NASA SP-4009, 1973).
- Brooks, Courtney G., and Ertel, Ivan D. *The Apollo Spacecraft: A Chronology, Volume III, October 1, 1964–January 20, 1966* (NASA SP-4009, 1973).
- Ertel, Ivan D., and Newkirk, Roland W., with Brooks, Courtney G. *The Apollo Spacecraft: A Chronology, Volume IV, January 21, 1966–July 13, 1974* (NASA SP-4009, 1978).
- Astronautics and Aeronautics, 1968: Chronology of Science, Technology, and Policy* (NASA SP-4010, 1969).
- Newkirk, Roland W., and Ertel, Ivan D., with Brooks, Courtney G. *Skylab: A Chronology* (NASA SP-4011, 1977).
- Van Nimmen, Jane, and Bruno, Leonard C., with Rosholt, Robert L. *NASA Historical Data Book, Vol. I: NASA Resources, 1958–1968* (NASA SP-4012, 1976, rep. ed. 1988).
- Ezell, Linda Neuman. *NASA Historical Data Book, Vol II: Programs and Projects, 1958–1968* (NASA SP-4012, 1988).
- Ezell, Linda Neuman. *NASA Historical Data Book, Vol. III: Programs and Projects, 1969–1978* (NASA SP-4012, 1988).
- Astronautics and Aeronautics, 1969: Chronology of Science, Technology, and Policy* (NASA SP-4014, 1970).
- Astronautics and Aeronautics, 1970: Chronology of Science, Technology, and Policy* (NASA SP-4015, 1972).
- Astronautics and Aeronautics, 1971: Chronology of Science, Technology, and Policy* (NASA SP-4016, 1972).

- Astronautics and Aeronautics, 1972: Chronology of Science, Technology, and Policy* (NASA SP-4017, 1974).
- Astronautics and Aeronautics, 1973: Chronology of Science, Technology, and Policy* (NASA SP-4018, 1975).
- Astronautics and Aeronautics, 1974: Chronology of Science, Technology, and Policy* (NASA SP-4019, 1977).
- Astronautics and Aeronautics, 1975: Chronology of Science, Technology, and Policy* (NASA SP-4020, 1979).
- Astronautics and Aeronautics, 1976: Chronology of Science, Technology, and Policy* (NASA SP-4021, 1984).
- Astronautics and Aeronautics, 1977: Chronology of Science, Technology, and Policy* (NASA SP-4022, 1986).
- Astronautics and Aeronautics, 1978: Chronology of Science, Technology, and Policy* (NASA SP-4023, 1986).
- Astronautics and Aeronautics, 1979-1984: Chronology of Science, Technology, and Policy* (NASA SP-4024, 1988).
- Astronautics and Aeronautics, 1985: Chronology of Science, Technology, and Policy* (NASA SP-4025, 1990).
- Gawdiak, Ihor Y., compiler. *NASA Historical Data Book, Vol. IV: NASA Resources, 1969-1978* (NASA SP-4012, 1994).

Management Histories, NASA SP-4100:

- Rosholt, Robert L. *An Administrative History of NASA, 1958-1963* (NASA SP-4101, 1966).
- Levine, Arnold S. *Managing NASA in the Apollo Era* (NASA SP-4102, 1982).
- Roland, Alex. *Model Research: The National Advisory Committee for Aeronautics, 1915-1958* (NASA SP-4103, 1985).
- Fries, Sylvia D. *NASA Engineers and the Age of Apollo* (NASA SP-4104, 1992).
- Glennan, T. Keith. *The Birth of NASA: The Diary of T. Keith Glennan*, edited by J. D. Hunley (NASA SP-4105, 1993).

Project Histories, NASA SP-4200:

- Swenson, Loyd S., Jr., Grimwood, James M., and Alexander, Charles C. *This New Ocean: A History of Project Mercury* (NASA SP-4201, 1966).
- Green, Constance McL., and Lomask, Milton. *Vanguard: A History* (NASA SP-4202, 1970; rep. ed. Smithsonian Institution Press, 1971).
- Hacker, Barton C., and Grimwood, James M. *On Shoulders of Titans: A History of Project Gemini* (NASA SP-4203, 1977).
- Benson, Charles D., and Faherty, William Barnaby. *Moonport: A History of Apollo Launch Facilities and Operations* (NASA SP-4204, 1978).
- Brooks, Courtney G., Grimwood, James M., and Swenson, Loyd S., Jr. *Chariots for Apollo: A History of Manned Lunar Spacecraft* (NASA SP-4205, 1979).
- Bilstein, Roger E. *Stages to Saturn: A Technological History of the Apollo/Saturn Launch Vehicles* (NASA SP-4206, 1980).
- Compton, W. David, and Benson, Charles D. *Living and Working in Space: A History of Skylab* (NASA SP-4208, 1983).

- Ezell, Edward Clinton, and Ezell, Linda Neuman. *The Partnership: A History of the Apollo-Soyuz Test Project* (NASA SP-4209, 1978).
- Hall, R. Cargill. *Lunar Impact: A History of Project Ranger* (NASA SP-4210, 1977).
- Newell, Homer E. *Beyond the Atmosphere: Early Years of Space Science* (NASA SP-4211, 1980).
- Ezell, Edward Clinton, and Ezell, Linda Neuman. *On Mars: Exploration of the Red Planet, 1958-1978* (NASA SP-4212, 1984).
- Pitts, John A. *The Human Factor: Biomedicine in the Manned Space Program to 1980* (NASA SP-4213, 1985).
- Compton, W. David. *Where No Man Has Gone Before: A History of Apollo Lunar Exploration Missions* (NASA SP-4214, 1989).
- Naugle, John E. *First Among Equals: The Selection of NASA Space Science Experiments* (NASA SP-4215, 1991).
- Wallace, Lane E. *Airborne Trailblazer: Two Decades with NASA Langley's Boeing 737 Flying Laboratory* (NASA SP-4216, 1994).

Center Histories, NASA SP-4300:

- Rosenthal, Alfred. *Venture into Space: Early Years of Goddard Space Flight Center* (NASA SP-4301, 1985).
- Hartman, Edwin P. *Adventures in Research: A History of Ames Research Center, 1940-1965* (NASA SP-4302, 1970).
- Hallion, Richard P. *On the Frontier: Flight Research at Dryden, 1946-1981* (NASA SP-4303, 1984).
- Muenger, Elizabeth A. *Searching the Horizon: A History of Ames Research Center, 1940-1976* (NASA SP-4304, 1985).
- Hansen, James R. *Engineer in Charge: A History of the Langley Aeronautical Laboratory, 1917-1958* (NASA SP-4305, 1987).
- Dawson, Virginia P. *Engines and Innovation: Lewis Laboratory and American Propulsion Technology* (NASA SP-4306, 1991).
- Dethloff, Henry C. *"Suddenly Tomorrow Came . . .": A History of the Johnson Space Center, 1957-1990*. (NASA SP-4307, 1993).

General Histories, NASA SP-4400:

- Corliss, William R. *NASA Sounding Rockets, 1958-1968: A Historical Summary* (NASA SP-4401, 1971).
- Wells, Helen T., Whiteley, Susan H., and Karegeannes, Carrie. *Origins of NASA Names* (NASA SP-4402, 1976).
- Anderson, Frank W., Jr. *Orders of Magnitude: A History of NACA and NASA, 1915-1980* (NASA SP-4403, 1981).
- Sloop, John L. *Liquid Hydrogen as a Propulsion Fuel, 1945-1959* (NASA SP-4404, 1978).
- Roland, Alex. *A Spacefaring People: Perspectives on Early Spaceflight* (NASA SP-4405, 1985).
- Bilstein, Roger E. *Orders of Magnitude: A History of the NACA and NASA, 1915-1990* (NASA SP-4406, 1989).

New Series in NASA History, published by The Johns Hopkins University Press:

Cooper, Henry S. F., Jr. *Before Lift-Off: The Making of a Space Shuttle Crew* (1987).

McCurdy, Howard E. *The Space Station Decision: Incremental Politics and Technological Choice* (1990).

Hufbauer, Karl. *Exploring the Sun: Solar Science Since Galileo* (1991).

McCurdy, Howard E. *Inside NASA: High Technology and Organizational Change in the U.S. Space Program* (1993).