

SP-2012-4012

NASA HISTORICAL DATA BOOK Volume VIII

NASA Earth Science and Space Applications,
Aeronautics, Technology, and Exploration,
Tracking and Data Acquisition/Space Operations,
Facilities and Resources
1989–1998

Judy A. Rumerman

The NASA History Series



National Aeronautics and Space Administration
Office of Communications
History Program Office
Washington, DC

ISBN 978-0-16-081420-4

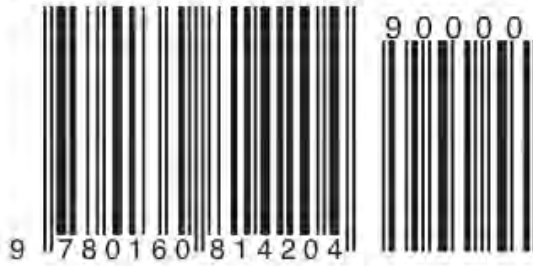

For sale by the Superintendent of Documents, U.S. Government Printing Office
Internet: bookstore.gpo.gov Phone: toll free (866) 512-1800; DC area (202) 512-1800
Fax: (202) 512-2104 Mail: Stop IDCC, Washington, DC 20402-0001

ISBN 978-0-16-081420-4

Library of Congress Cataloging-in-Publication Data
(Revised for vol. 8)

NASA historical data book.

(NASA SP- 2012-4012)

Vol. 1 is a republication of NASA historical data book,
1958–1968 / Jane Van Nimmen and Leonard C. Bruno.

Vol. 8 in series: The NASA historical data book series.

Includes bibliographical references and indexes.

Contents: v. 1 NASA resources, 1958–1968 / Jane Van
Nimmen and Leonard C. Bruno — v. 2. Programs and projects,
1958–1968 / Linda Neuman Ezell — v. 3. Programs and projects,
1969–1978 / Linda Neuman Ezell — v. 4. NASA resources, 1969–
1978 / Ihor Gawdiak with Helen Fedor — v. 5. NASA launch
systems, space transportation, human spaceflight, and space
science, 1979–1988 / Judy A. Rumerman — v. 6. NASA Space
Applications, Aeronautics and Space Research and Technology,
Tracking and Data Acquisition/Support Operations, Commercial
Programs, and Resources 1979–1988 / Judy A. Rumerman — v. 7. NASA Launch Systems,
Space Transportation, Human Spaceflight, and Space Science 1989-1998/ Judy A. Rumerman —
v. 8. NASA Earth Science and Space Applications, Aeronautics, Technology, and Exploration,
Tracking and Data Acquisition/Space Operations, Facilities and Resources 1989–1998 / Judy A.
Rumerman

1. United States. National Aeronautics and Space
Administration—History. I. Van Nimmen, Jane. II. Bruno,
Leonard C. III. Ezell, Linda Neuman. IV. Gawdiak, Ihor. V.
Rumerman, Judy A — v. VI.

VI. Series. VII. Series. VIII. Series: NASA SP-4012.

Table of Contents

Preface and Acknowledgments.....	v
About the Compiler.....	vi
Chapter One: Introduction	1
Chapter Two: Earth Science and Space Applications.....	4
Chapter Three: Aeronautics, Technology, and Exploration.....	220
Chapter Four: Tracking and Data Acquisition/Space Operations	528
Chapter Five: Facilities and Field Centers.....	608
Chapter Six: NASA Personnel.....	675
Chapter Seven: Finances and Procurement.....	685
NASA History Series List.....	710

Preface and Acknowledgments

In 1973, NASA published the first volume of the *NASA Historical Data Book*, a hefty tome containing mostly tabular data on the resources of the space Agency between 1958 and 1968. There, broken into detailed tables, were facts and figures associated with the budget, facilities, procurement, installations, and personnel of NASA during that formative decade. In 1988, NASA reissued that first volume of the data book and added two additional volumes (one for 1958–1968 and one for 1969–1978) on the Agency’s programs and projects. NASA published a fourth volume in 1994 that addressed NASA’s resources for the period between 1969 and 1978. In 1999, it published volume V of the data book, which contained narrative and tabular information on the Agency’s launch systems, space transportation, human spaceflight, and space science programs between 1979 and 1988. Volume VI, published in 2000, was a continuation of those earlier efforts and addressed the Agency’s space applications efforts, the development and operation of aeronautics and space research and technology programs, tracking and data acquisition/space operations, commercial programs, facilities and installations, personnel, and finances and procurement during that era.

Volume VII, published in 2008, addressed the decade from 1989 to 1998. It consisted of narrative and tabular material on the Agency’s launch systems, space transportation, human spaceflight, and space science programs. This eighth volume continues those earlier efforts. This fundamental reference tool presents information, much of it statistical, documenting the development of several critical areas of NASA responsibility for the period between 1989 and 1998. This volume includes detailed information on NASA’s Earth science/space applications efforts, the development and operation of aeronautics and space research and technology programs, tracking and data acquisition/space operations, facilities and installations, personnel, and finances and procurement during this era.

Special thanks are owed to my student research assistant, Tai Edwards, who gathered and organized much of the reference material for this volume and set up the many tables—a particularly tedious and exacting undertaking. The reviewers of these chapters provided an invaluable service, often pointing out important errors and omissions.

Numerous people at NASA associated with historical study, technical information, and the mechanics of publishing helped in many ways to prepare this historical data book. Thanks are due to members of the NASA community around the county who provided material and helped fill in gaps in my information. Stephen Garber managed the contract and project, overseeing all aspects of the publication. NASA History Office Chief Archivist Jane Odom, History Office archivists Colin Fries and John Hargenrader, and staff at the NASA Headquarters and Goddard Space Flight Center libraries helped locate sometimes elusive information. Center historians provided information relating to their particular centers, and individuals in the Office of Human Resources and the Facilities Engineering Division were helpful in providing and explaining data regarding those areas.

Publishing professionals at NASA Headquarters and Maryland Composition prepared the manuscript for publication.

Thanks are due to them all.

About the Compiler

Judith A. Rumerman is a professional technical writer who has written or contributed to numerous documents for the National Aeronautics and Space Administration. She has written documents describing various spaceflight programs, in-house procedures used at Goddard Space Flight Center, and various materials used for training. She was also the compiler of *U.S. Human Spaceflight: A Record of Achievement, 1961–1998*, a monograph for the NASA History Office detailing NASA’s human spaceflight missions, and volumes five and six of the *NASA Historical Data Book, 1979–1988*. In the years preceding the 2003 Centennial of Flight, Ms. Rumerman served as technical lead and prime author of the series of essays written for the Centennial of Flight Commission describing all aspects of aviation and spaceflight aimed at young people of high-school age.

Ms. Rumerman has degrees from the University of Michigan and George Washington University. She grew up in Detroit and presently lives in Silver Spring, Maryland.

Notes on Sources

The bulk of the sources used in preparing this volume were official NASA documents and references. Whenever possible, the author attempted to use primary sources prepared by the organizations or individuals most directly involved in a program or mission. NASA Web sites were also used extensively. Secondary sources were most often used to provide perspective rather than data. The following paragraphs describe major sources. Detailed footnotes are provided in each chapter.

Annual Budget Estimates. These documents are issued each year by the NASA Office of the Chief Financial Officer when the annual budget request is presented to Congress. These lengthy documents (filling several loose-leaf binders each year) contain breakdowns of the budgets for three fiscal years: the year just ending, the next fiscal year, and the fiscal year two years out. Budget figures are presented by appropriation, program office, installation, program, and in any other way that may be of interest to budget preparers. Toward the end of this decade, a “full-cost” accounting method was adopted, and budget figures for major programs began to be presented in both the traditional way and in full-cost figures. Budget estimate documents also provide comprehensive narrative descriptions of programs and activities, describing both what occurred during a prior fiscal year (and occasionally further back) and what the Agency’s plans are for the next two years. These descriptions provide a useful account of a program’s evolution.

Press and Media Kits. NASA prepares press or media kits for every Space Shuttle mission and a number of major robotic missions. They describe launch events, payloads, planned experiments, astronaut biographies, and other mission-unique information. Designed for nontechnical audiences and the media, they provide a comprehensive description of NASA missions. All Shuttle press kits and most other press kits are available online.

Mission Operation Reports. Every NASA mission is required to prepare a pre- and postlaunch mission operation report. These reports are designed for the use of senior management, and although they are part of the NASA Historical Reference Collection, they may not always be available to the public. They provide material similar to that found in the press kits but may also include more technical information, and the postlaunch reports may include assessments of the success of various mission elements.

Aeronautics and Space Reports of the President. These annual reports describe the aeronautics and space activities of all government agencies that engage in these types of activities. They provide a good overview and an excellent starting point for research. They were especially helpful in the chapter describing NASA’s aeronautics activities, since aeronautics generally falls into the research and technology area, and many efforts in this area do not result in an event comparable to the launch of a space mission.

Press Releases. NASA Headquarters and each NASA center regularly issue press releases describing newsworthy events. They provide the current status on various events, including scientific missions, management and organizational changes, contract awards, and changing Agency priorities. They are often the only source of current, detailed information about a mission. Headquarters press releases have been posted on the NASA Web site since the early 1990s. The centers began posting their press releases in the mid-1990s.

Exploring the Unknown, Selected Documents in the History of the U.S. Civil Space Program, Volume VI: Space and Earth Science, edited by John Logsdon. The introductory essay by John H. McElroy and Ray A. Williamson preceding the documents in this volume provides an outstanding overview of the evolution of the Earth Observing System (EOS), which may be the most important Earth science program conducted by NASA during this decade.

Uplink-Downlink: A History of the Deep Space Network 1957–1997, by Douglas J. Mudgway. This book provides an excellent and extremely useful description of the Deep Space Network during the decade described in the current volume. It was especially useful in detailing changes made in the management structure at the Jet Propulsion Laboratory. Personnel at the Canberra and Goldstone complexes were also helpful in supplementing the published material.

Web sites. The past few years have seen an explosion of material posted on the Internet. Every NASA program has a Web site (too many to list here) and posts a wide variety of information about a project. This has had both positive and negative consequences. On the positive side, official documents, such as those involving legislation, policies, Agency reports, and directives, are readily available. NASA programs post huge amounts of material describing all phases of a mission, including mission parameters and specifications, instrument descriptions, scientific results, implications, etc. This information enables researchers to acquire a great deal of information without having to cull through files or archives. However, it is also very easy for errors to be perpetuated, even when information is located on NASA Web sites. Information is easily copied from one Web site to the next, often without question, and errors are inadvertently introduced when material is not carefully edited. It is necessary for the researcher to verify information carefully before using it. Another issue is that sometimes information will be removed from a Web site because of storage considerations before it is archived. Information “disappears” or is moved to another location on the Internet. This happens especially when information becomes “out of date” and there is no concern for the historical value of the material. Broken links, due both to technical difficulties and the removal or moving of Web pages without revising the referring link, are also a problem. Web material has been used extensively in this volume, but care has been taken to ensure its reliability. An “accessed” date is always included, and a printed copy of all Web pages used has been provided to the NASA History Division.

Each NASA project has a Web site of varying levels of detail and quality. Some provide extensive information about the mission and science results, while others provide only basic information. Some projects have more than one Web site—one dealing with mission elements and a second dealing primarily with the science.

The Canberra Deep Space Complex has an especially useful Web site that describes in detail the history and facilities of the complex. The Goldstone Complex’s Web site was also helpful. Madrid did not have much information available online, and Mudgway was the best source for information on that complex.

NASA Space Science Data Center. While it is not easy to navigate, the Master Catalog on the NSSDC database is often the only available source of basic information for each mission. Its pages supply a brief description of each mission, as well as orbital information and a list of the

instruments used (with a description of each), often with the names and affiliations of the Principal Investigators.

Human Resources Information. The NASA Office of Human Resources has created an extensive “data cube” that contains a vast amount of statistical data relating to NASA personnel beginning in FY 1992. This information was an invaluable source for creating the tables in the NASA personnel chapter. Data for earlier years were obtained from annual NASA Civil Service Workforce reports.

Procurement Information. Information from the comprehensive annual procurement reports published by the NASA Office of Procurement was used to create the tables in the chapter on NASA procurement activities. Information on the procurement regulations came primarily from the Federal Acquisition Regulations (FAR) and NASA FAR Supplement (NFS). Because the period described in this volume covers the years 1989–1998, the FAR and NFS for those years were used as references to reflect the status of regulations during that decade.

Facilities and Center Information. Accurate information on center associate administrators was generally available from the NASA History Office. However, the names and dates of associate administrators were exceedingly difficult to obtain from some centers, requiring the assistance of the Office of the Administrator at the center, individuals in the center’s Human Resources Office, librarians, and historians. The NASA Headquarters Facilities Engineering Division prepares spreadsheets detailing the physical facilities at Headquarters and each NASA center. Some of the information is included as a page in the annual budget estimates. Other information was obtained directly from the division. Information relating to the wind tunnels and similar facilities at the centers generally was obtained from center Web sites and personnel at the appropriate centers. No publications describe in a comprehensive fashion the changes made to the tunnels in the decade addressed in this volume. However, Frank E. Peñaranda and M. Shannon Freda provided a good starting point in *Aeronautical Facilities Catalogue, Volume 1, Wind Tunnels* (compiled in 1985), since a large number of tunnels have not changed since then.

Graphics. The graphics in this volume were acquired from many sources. The majority of the photographs were obtained from various NASA image libraries, including the NASA Image Exchange (NIX), the Great Images in NASA (GRIN) system, and the image libraries maintained by the individual centers. If there was an identifying number assigned to the photograph, the caption describing the photograph includes it. Some photographs provided by projects do not include an identifying number because the project does not use a numbering system. A few photographs were loaned to the author by project personnel, scanned, and returned to the owner. The diagrams in this volume generally came from documents such as press kits, reports, and NASA directives. These images were scanned at a resolution suitable for printing and “cleaned up” to eliminate stray marks. Sometimes the text was reentered to achieve a consistent style or to eliminate typographical errors. Organizational charts were usually redrawn by the author so that each would be consistent with the others in style. Other graphics were scans of images in company or project brochures, or in material provided to the author. They also may have been modified digitally to improve their quality or resolution.

CHAPTER 1: INTRODUCTION

During the period between 1989 and 1998, NASA experienced what may have been its most productive decade ever. The Agency resumed human spaceflight after the 1986 *Challenger* accident, began constructing the International Space Station (ISS), launched two of NASA's four "Great Observatories," and increasingly focused on characterizing Earth's environment. Much of this work took place in a time of decreasing budgets and a push to accomplish more "faster, better, and cheaper."

Earth Science and Space Applications

NASA's Earth science and applications missions focused on observing Earth and its atmosphere and environment to improve life on the planet. During this decade, NASA stressed Earth system science—the observation and analysis of the integrated systems of Earth that incorporated the physical, chemical, and biological aspects of the planet—and concentrated on global change. In collaboration with other federal agencies and international partners, the Agency carried out a wide variety of observation and research programs conducted both from spacecraft in orbit around Earth and from aircraft. The Mission to Planet Earth (MTPE) program was the cornerstone of NASA's Earth science activities, a global-scale examination of Earth that studied the interaction of all the environmental components—air, water, land, and life—constituting the Earth's system. Additionally, NASA participated in a series of operational meteorological and land remote sensing missions.

Aeronautics, Technology, and Exploration

The Agency's aeronautics, research and technology, and exploration activities built on a foundation established during the era of the National Advisory Committee for Aeronautics (NACA), NASA's predecessor agency. Its aeronautics activities focused on meeting national goals in the subsonic, transatmospheric, and supersonic regions of flight. Space research and technology initiatives supported and provided technology related to the Space Shuttle, America's launch systems and satellites, and the ISS. These activities focused on future civil space missions, improving access to space and providing a base of research and technology to support all national space goals. Exploration activities grew largely out of recommendations made by a committee—chaired by former NASA astronaut Sally Ride—to the NASA Administrator in 1987 and presidential initiatives in the late 1980s and early 1990s on the importance of regaining America's leadership in space endeavors following the *Challenger* accident.

NASA's state-of-the-art wind tunnel facilities played a major role in the development of improved aircraft and technology. While some tunnel facilities closed during this decade as part of efforts to increase efficiency and reduce duplication, some older facilities upgraded and added new capabilities.

Tracking and Data Acquisition/Space Operations

NASA's tracking and data acquisition and space operations activities during the decade from 1989 to 1998 provided vital support for all NASA flight projects and, on a reimbursable basis, supported projects of the Department of Defense (DOD) and other government agencies, commercial firms, and other countries and international organizations engaged in space research

activities. This support was essential for achieving the objectives of all flight missions. During this decade, the Tracking and Data Relay Satellite System (TDRSS) became operational, reducing the need for an extensive system of ground tracking stations. Consequently, many ground stations closed, leaving only a few to support the Space Shuttle and spacecraft not compatible with the TDRSS network. NASA built a second Tracking Ground Terminal at White Sands, New Mexico, primarily to support TDRSS operations. At the same time, the three Deep Space Network (DSN) complexes continued to improve and upgrade their antenna facilities to support the growing number of spacecraft launched into deep space.

Facilities and Resources

During the 10 years between 1979 and 1988, NASA's facilities remained essentially the same as in the previous decade. The major administrative change was the return of Dryden Flight Research Facility to independent center status. Personnel decreased in number during the decade but became more diverse and better educated. NASA's real budget also fell as President Bill Clinton worked to reduce the federal deficit, and the Agency was asked to do more with fewer resources. In the procurement area, mergers of aerospace firms consolidated major contracts among fewer businesses. NASA also became more efficient by consolidating several smaller contracts into fewer large procurements.

CHAPTER 2: EARTH SCIENCE AND APPLICATIONS

Introduction

This chapter addresses NASA's Earth science and applications activities between 1989 and 1998. Earth science and applications missions focus on observing Earth and its atmosphere and environment to improve life on the planet. This chapter also looks at technology in terms of materials science, fluid science, and physical processes, as well as addressing practical applications related to the microgravity environment as it affects humans in space.

As is customary in these data books, most material in this chapter is based on primary NASA documents and Web-based materials produced by NASA. These include pre- and post-launch mission operation reports, press kits and press releases, key personnel announcements, and various reports and plans issued by the Agency. For Shuttle-based application activities, the Space Shuttle mission archives and mission chronologies were consulted. The NASA projects themselves have been plentiful sources of data. Most have comprehensive Web sites, and many also publish information booklets and fact sheets. Partner agencies, such as the European Space Agency (ESA), also publish printed and online material regarding their joint activities with NASA, as do the academic and private-sector institutions and organizations that are the homes of researchers and investigators. Most budget material comes from the annual budget estimates generated by the NASA Office of the Chief Financial Officer and from federal budget legislation. Other government agencies and organizations, including the General Accounting Office (GAO), the Congressional Research Service, and the National Oceanic and Atmospheric

Administration (NOAA), also issue reports and documents used as reference material.¹

Measurements are presented in the unit used in the original reference (metric or English), and the conversions are in parentheses.

The Last Decade Reviewed (1979–1988)

Most Earth science and space applications missions launched by NASA during the decade from 1979 to 1988 were commercial missions or missions managed by government agencies other than NASA. Only the Stratospheric Aerosol and Gas Experiment (SAGE), the Magnetic Field Satellite (Magsat), and the Earth Radiation Budget Satellite (ERBS) were NASA missions.

NASA's other Earth science and applications missions took place aboard the Space Shuttle.

SAGE and Magsat were part of NASA's Applications Explorer Mission program. NASA's other environmental observations missions consisted of two sets of meteorological satellites, both of which were operated by NOAA. NOAA operated this series of polar-orbiting satellites and the geosynchronous Geostationary Operational Environmental Satellites (GOES) after NASA developed and launched them. The earlier Nimbus satellites, which were also transferred from NASA to NOAA, continued to operate during this decade as well.

The extent and effects of ozone and ozone depletion were a major focus of the decade. The Total Ozone Monitoring Spectrometer (TOMS) on Nimbus-7 provided the first global maps of total ozone with high spatial and temporal resolution beginning in the late 1970s. The Nimbus satellites continued to provide data on ozone levels from their backscatter ultraviolet instruments. NASA reported to Congress and the U.S. Environmental Protection Agency (EPA) its assessment of key processes in the stratosphere, especially the effects of human-produced chemicals in the ozone layer. The urgency of the upcoming Upper Atmosphere Research

¹ The General Accounting Office became the Government Accountability Office in 2004.

Satellite (UARS)—the first satellite capable of simultaneously measuring the energy input, chemical composition, and dynamics of the stratosphere and mesosphere—was emphasized by the discovery of an ozone hole in the Antarctic and ozone depletion in the Arctic.

In the area of resource observations, NASA continued its involvement in space-based operational civilian remote-sensing activities primarily through the Landsat program, managed by NOAA in the first part of the decade and later operated by the Earth Observation Satellite Company (EOSAT). During this decade, NASA launched Landsats 4 and 5, which provided better resolution than earlier satellites.

From 1979 to 1988, NASA's role in the communications satellite field was primarily as a provider of launch services. The Agency launched 65 operational communications satellites for several governments and communication companies. These commercial missions enabled NASA to use some of its launch capabilities for the first time, such as the first use of the payload assist module in place of a conventional expendable launch vehicle third stage, and the first launch of a payload from the Shuttle's cargo bay. NASA's communications activities centered on its Search and Rescue Satellite-Aided Tracking (SARSAT) system, the development of the Advanced Communications Technology Satellite (ACTS), continued work on the mobile satellite program, and development of an information systems program to handle the huge quantities of data returned from space missions.

Earth Science and Applications Overview (1989–1998)

NASA's focus on Earth science and applications began early in the Agency's history with its first Earth-observing satellite, TIROS-1. Over the next two decades, NASA increasingly made

broader and more precise and sophisticated measurements while improving the technology needed to observe Earth. During the decade from 1989 to 1998, NASA stressed Earth system science—the observation and analysis of the integrated systems of Earth, incorporating the physical, chemical, and biological aspects of the planet—and concentrated on global change. In collaboration with other federal agencies and international partners, the Agency carried out a wide variety of observation and research programs conducted both from spacecraft in orbit around Earth and from aircraft.

Beginning in 1991, the MTPE program became the cornerstone of NASA's Earth science activities as NASA formally began a global-scale examination of Earth to study the interaction of all the environmental components—air, water, land, and life—constituting Earth's system. Much of the national effort was coordinated through the U.S. Global Change Research Program (USGCRP). Internationally, NASA collaborated with Japan, ESA, individual European nations, Russia, and Canada on several key spacecraft and instruments for programs in every area of environmental research. The Agency also was active in such international bodies as the Intergovernmental Panel on Climate Change, the World Climate Research Program, and the International Geosphere-Biosphere Program.² This global program was NASA's long-term, coordinated research effort to study Earth as a global environmental system.

The first phase of MTPE consisted of free-flying satellites, such as UARS, and Space Shuttle missions, such as the Atmospheric Laboratory for Applications and Science (ATLAS). Airborne and ground-based studies complemented the space missions. Phase 2 consisted of the Earth Observing System (EOS) satellites, whose overall goal was to advance understanding of the

² "Mission to Planet Earth Strategic Enterprise Plan, 1995–2000," NASA Headquarters, Washington, DC; 1995, 5.

entire Earth system on a global scale by improving our knowledge of the components of the system, the interactions among them, and how Earth's system is changing.³

Additionally, NASA participated in a series of operational meteorological and land remote-sensing missions in partnership with NOAA and the U.S. Geologic Survey (USGS). The Space Shuttle also carried missions that focused on the microgravity environment in terms of both its impact on humans and its role in technological processes. Most of these were Spacelab missions, and some used Spacelab hardware but operated automatically or remotely without the participation of the Shuttle crew. Other missions studying the microgravity environment involved small satellites that were released from the Shuttle for a short period of time, either to fly freely in the vicinity of the Shuttle or to conduct experiments perched on the end of the Shuttle's robot arm. These satellites were then retrieved, reberthed in the Shuttle, and returned to Earth.

This chapter discusses the Earth science and applications missions launched between 1989 and 1998 in which NASA had a role and several almost completely developed during the decade and launched soon after. It also discusses several missions carried on board the Space Shuttle. Tables 2-1 and 2-2 list the missions addressed in this chapter.

³ "NASA's Mission to Planet Earth: Space-Based Missions, 1994–2000," NASA History Division folder 18482, Historical Reference Collection, NASA Headquarters, Washington, DC, 1994.

Management of NASA's Earth Science and Applications Program

At the start of the 1989–1998 decade, Earth science and applications missions were managed by the Office of Space Science and Applications (OSSA), referred to within NASA as Code E. This combined organization had been established in November 1981. At the start of 1989, the divisions within OSSA relating to Earth science and applications were Earth Science and Applications, Microgravity Science and Applications, and Communications and Information Systems (see figure 2-1). The remaining divisions were Space Physics, Solar System Exploration, Astrophysics, and Life Sciences (discussed elsewhere in these data books). Dr. Lennard A. Fisk was Associate Administrator of OSSA; Ray J. Arnold headed the Communications and Information Systems Division; Dr. Shelby Tilford led the Earth Science and Applications Division; and Robert A. Schmitz was acting head of the Microgravity Science and Applications Division. In April 1990, an administrative action changed the letter designation for OSSA to Code S, but the functions and organization remained exactly the same.⁴

⁴ Richard Truly to Officials-in-Charge of Headquarters Offices, "Headquarters Organization/Mail Codes," April 26, 1990, NASA History Division folder 009524, Historical Reference Collection, NASA Headquarters, Washington, DC.

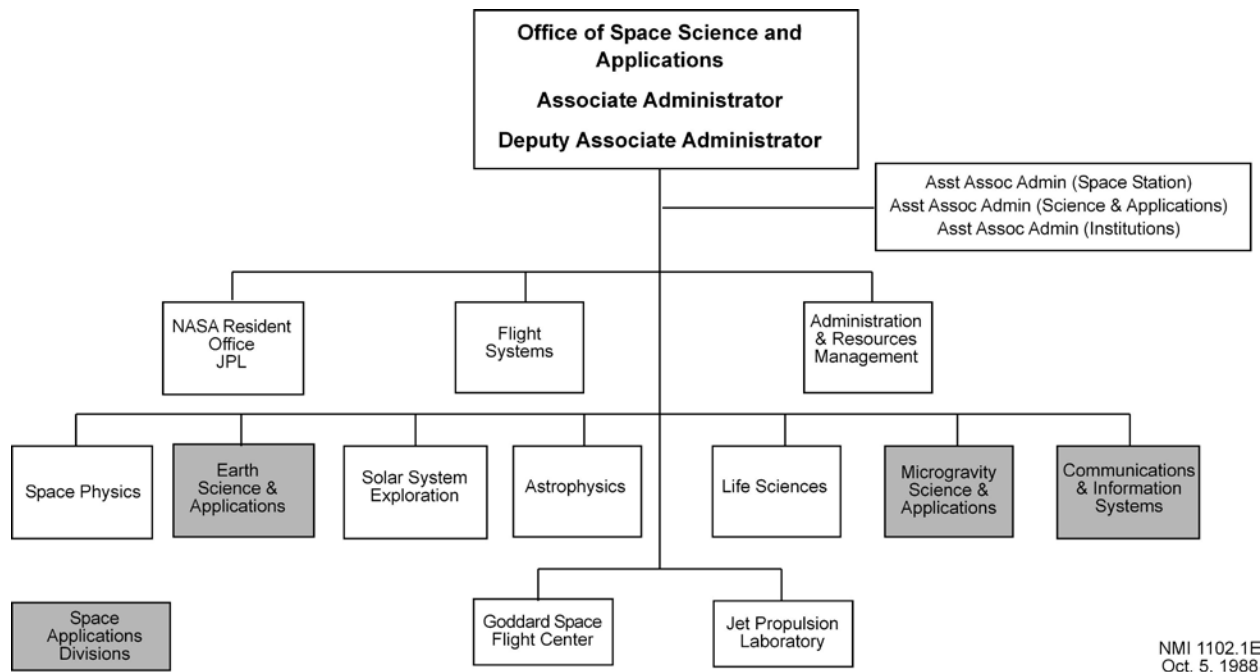

Figure 2-1. Office of Space Science and Applications, 1983–1993.

In the spring of 1991, Robert Rhome became head of the Microgravity Science and Applications Division. Around the same time, the Communications and Information Systems Division was disestablished.⁵ Its head, Ray Arnold, moved to the Office of Commercial Programs.

In July 1992, the roles and responsibilities assigned to OSSA changed to include responsibility for “planning, development, and operation of NASA missions that used the Space Shuttle, Spacelab, other Shuttle-attached payload carriers, and Space Station Freedom.” OSSA also assumed responsibility for managing and directing the expendable launch vehicle (ELV) and the

⁵ “Role and Responsibilities—Associate Administrator for Space Science and Applications,” NASA Management Instruction 1102.1F, July 31, 1991, NASA Headquarters, Washington, DC.

upper stages launch service program, including “planning, requirements, acquisition strategy, operations, and oversight.”⁶

In October 1992, NASA Administrator Daniel Goldin announced an Agencywide reorganization to “better focus NASA’s programs, to streamline how we do business so we can meet the challenges ahead” that, among other changes, affected the management of space and Earth science missions.⁷ OSSA first split into two organizations: one to manage space science missions, and one to manage Earth science and applications missions. Earth science and applications missions went to the new Office of Mission to Planet Earth (OMTPE) (Code Y). Space science missions went to the temporarily named Office of Planetary Science and Astrophysics (Code S).⁸

Effective with the new organization, Dr. Fisk moved from the position of Associate Administrator of the disbanded OSSA to become NASA’s Chief Scientist. Dr. Tilford became acting MTPE Associate Administrator. Dr. Robert Watson became OMTPE acting Chief Scientist as well as head of the OMTPE Science Division. The OMTPE Flight Systems Division was headed by Michael R. Luther, and Dr. Dixon Butler headed the Operations, Data, and Information Systems Division. These changes became effective in March 1993.⁹ Along with these changes, Goldin placed NASA’s life sciences and microgravity programs into a new

⁶ “Role and Responsibilities—Associate Administrator for Space Science and Applications,” NASA Management Instruction 1102.1H, July 30, 1992, NASA Headquarters, Washington, DC.

⁷ “Goldin Announces Changes in NASA Organization To Focus and Strengthen Programs and Management,” *NASA News Release 92-172*, NASA History Division folder 18429, Historical Reference Collection, NASA Headquarters, Washington, DC.

⁸ It was soon renamed the Office of Space Science.

⁹ “Assignment of Key Personnel and Establishment of New Offices,” NASA Special Announcement, March 11, 1993. See chapter 3 of volume VII of the *NASA Historical Data Book, 1989–1998*, for further discussion of OLMSA’s organization.

organization, the Office of Life and Microgravity Sciences and Applications (OLMSA), designated Code U at NASA. Dr. Harry Holloway was its first Associate Administrator. Later in the year, Dr. Tilford became OMTPE Chief Scientist.

The mission of MTPE was to develop programs to acquire a scientific understanding of the entire Earth system on a global scale by describing how its component parts and their interactions evolved, how they functioned, and how they might be expected to continue evolving on all timescales. The programs were managed by several divisions:

- The Flight Systems Division developed all MTPE flight systems, including EOS, Earth probes, Space Shuttle and aircraft payloads, and NOAA operational flight systems on a reimbursable basis. It also served as liaison to the Office of Space Flight for matters relating to the Space Shuttle, Office of Space Science for Expendable Launch Vehicle (ELV) matters, and OLMSA for flight systems interfaces.
- The Operations, Data, and Information Systems Division managed mission operations, data systems development, applications, and data management for MTPE programs, and served as liaison to the Office of Space Communications.
- The Science Division managed all science research efforts, defined flight programs related to MTPE, and served as liaison to the Office of Aeronautics for investigating the environmental impact of aviation.¹⁰ (See figure 2-2.)

¹⁰ “Role and Responsibilities—Associate Administrator for Mission to Planet Earth (AA/MTPE),” NASA Management Instruction 1102.16, June 28, 1993. NASA History Division folder 18429, Historical Reference Collection, NASA Headquarters, Washington, DC.

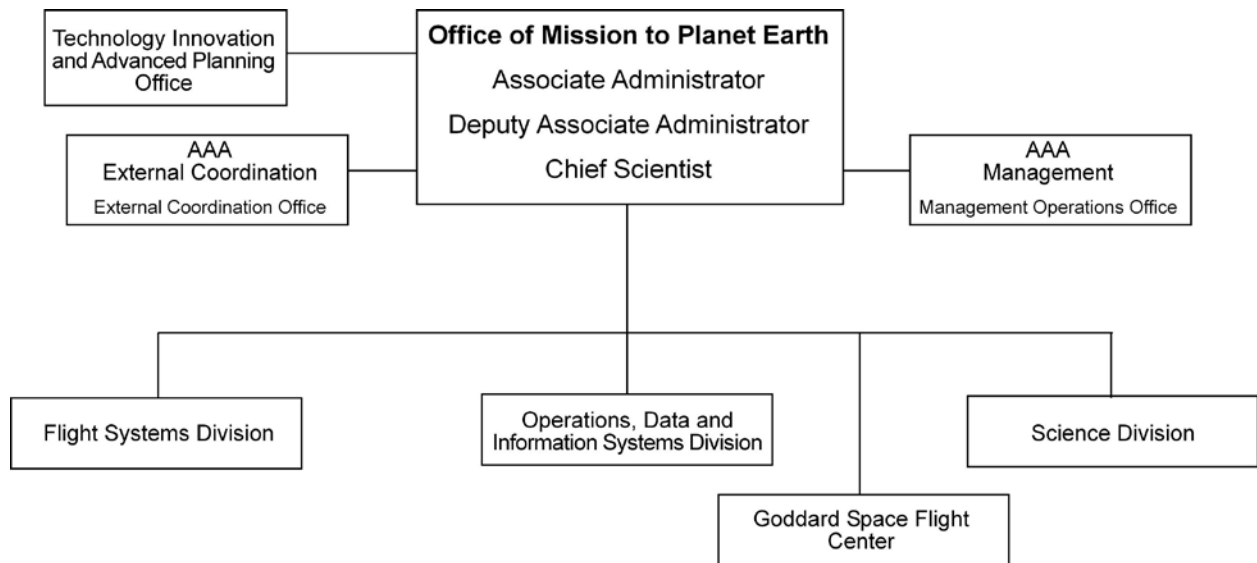

Figure 2-2. Office of Mission to Planet Earth organization, June 1993.

Goddard Space Flight Center (GSFC) in Greenbelt, Maryland, was the lead center for MTPE missions.

In January 1994, Administrator Goldin announced the appointment of Dr. Charles Kennel as Associate Administrator for OMTPE, replacing Dr. Tilford, acting Associate Administrator since the MTPE office was formed. Dr. Mark Abbott was also named Chief Scientist for OMTPE.¹¹ In mid-1994, Watson left his position as head of the OMTPE Science Division. He was replaced by Dr. Robert Harriss.

In 1995, NASA moved from an “office” structure to one of “strategic enterprises.” OMTPE became the Mission to Planet Earth Enterprise, one of NASA’s five strategic enterprises.¹²

¹¹ “NASA Administrator Announces Management Changes,” *NASA News Release 94-3*, January 6, 1994, <ftp://ftp.hq.nasa.gov/pub/pao/pressrel/1994/94-003.txt> (accessed February 23, 2005).

¹² NASA’s other strategic enterprises were Aeronautics, Human Exploration and Development of Space, Space Science, and Space Technology.

Dr. Kennel left NASA in January 1996 to return to the University of California, Los Angeles. William Townsend, Deputy Associate Administrator, became acting Associate Administrator. In mid-1996, the Flight Systems Division was abolished and a new division, Program Planning and Development, was established. Michael Luther, who had led the Flight Systems Division, became head of the new division. The Operations, Data, and Information Systems Division was also abolished.

Two significant changes in the management approach to MTPE were implemented in 1996. The MTPE program office at Goddard assumed a larger role when program management responsibilities were transferred from NASA Headquarters to Goddard. Also, the NASA Office of Space Access and Technology was disestablished with advanced technology development to be managed by the enterprises and coordinated by a Chief Technologist in the Office of the Administrator. With this change, MTPE assumed responsibility for the small spacecraft technology initiative (Lewis and Clark missions) and the commercial remote sensing program.¹³ NASA also established a lead center for microgravity research at Marshall Space Flight Center (MSFC).

At the start of 1998, MTPE Enterprise was renamed the Earth Science Enterprise. Acting Associate Administrator Townsend stated that “Earth Science” more clearly conveyed the program’s goals and more directly focused on the research being conducted. In February, Dr. Ghassem Asrar was selected as the new NASA Associate Administrator for Earth Science. The major divisions of the enterprise were Business, Program Planning and Coordination, Research,

¹³ “Science, Aeronautics, and Technology, Fiscal Year 1998 Estimates,” Budget Summary, Office of Mission to Planet Earth, NASA Headquarters, Washington, DC, SAT 3–5.

and Applications and Outreach. Figure 2-3 shows the organization's structure, including both its divisions and major programs and projects.

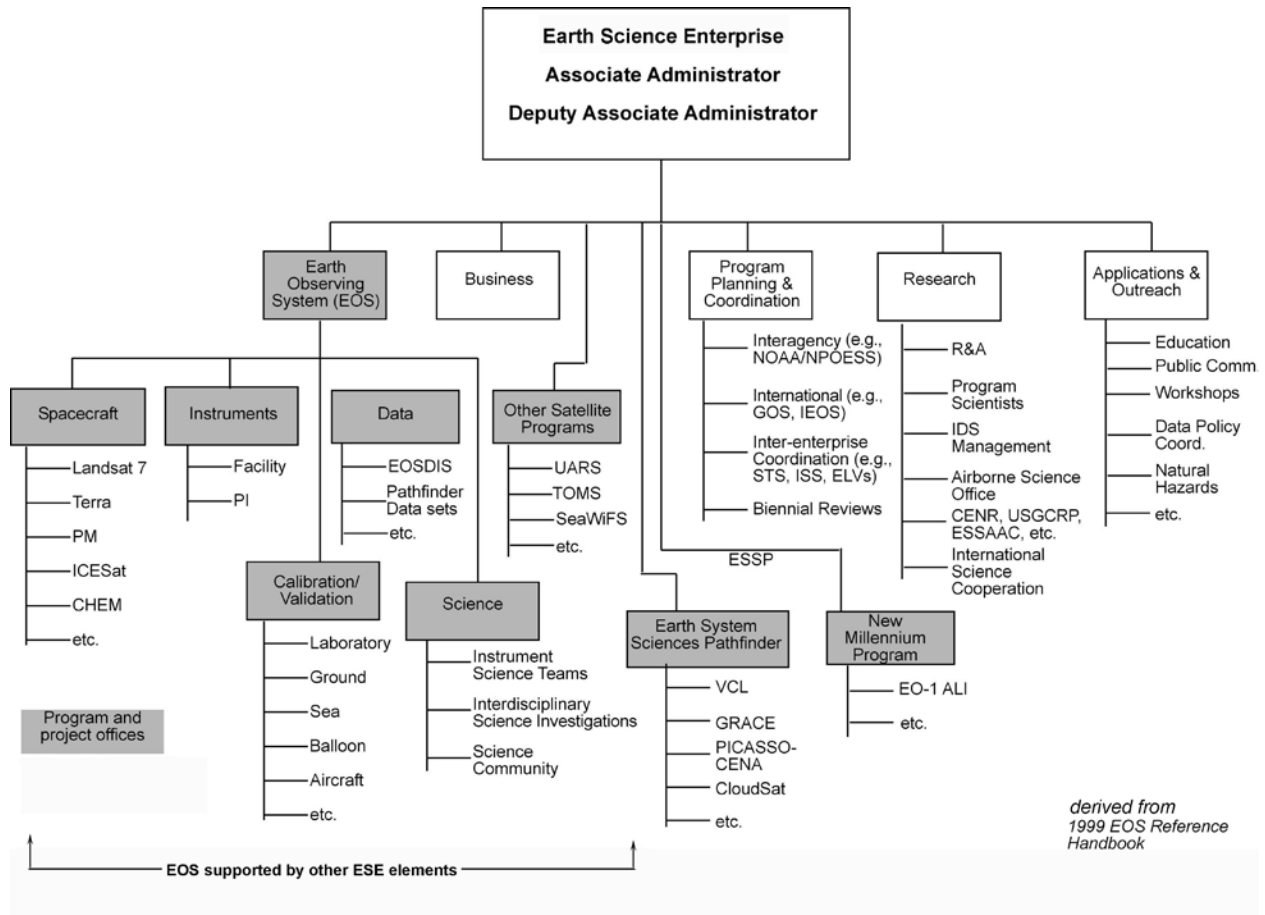

Figure 2-3. Earth Science organization structure, 1999.

Money for Earth Science and Applications

Funding levels for Earth science and applications activities reflected NASA's growing focus on assessing the condition of Earth's ozone layer and investigating Earth as an integrated system. In general, funding for Earth sciences during this decade increased. However, in fiscal year (FY) 1993, the funding level fell significantly. This reflected a major restructuring and realignment of the EOS program and a reduction in its scope. The decrease also reflected a restructuring of the

disbanded OSSA into separate offices for Space Science, Life and Microgravity Science and Applications, and MTPE. Funds for materials processing, Space Science Data Center activities associated with information systems, and search-and-rescue programs (all formerly considered Earth science and applications activities) were transferred to other program offices.¹⁴ Funding in FY 1994 recovered and surpassed the previous high point. It continued to grow, except in FY 1997, when it remained essentially flat. Table 2-3 shows programmed amounts for major budget categories.

During this decade, appropriation bills passed by Congress seldom specified amounts for NASA's individual programs, designating amounts only for the research and development (R&D) or (beginning with FY 1995) the Science, Aeronautics and Technology (SAT) appropriations category as a whole. In general, the Agency relied on conference committee reports for more specific direction.¹⁵ Thus, the tables in this chapter do not include appropriations data for Earth Science. The total amounts appropriated for R&D and the SAT categories can be found in chapter 7 of this volume.

The budget tables that follow (tables 2-4 to 2-54) show budget requests and programmed amounts for the programs within Earth science and applications. Since NASA typically submits an original and revised budget request before Congress acts on a budget, both amounts are indicated, separated by a "/." The original submission results from an extensive "budget exercise" performed by the individual projects and organizations at each NASA Center, in which

¹⁴ "Fiscal Year 1994 Estimates, Research and Development Budget Plan for Space Science and Applications," NASA Headquarters, Washington, DC, RD SSA-2.

¹⁵ Technically, directions from a conference committee are not legally binding. However, NASA generally follows the guidance contained in such reports.

managers and analysts take a detailed look at past costs and planned and anticipated costs for the next year and future years based on the project schedule and milestones. Changes stated in a revised submission often result from feedback to the Centers from Headquarters program offices that may have received input from the congressional authorization committee via the Office of Management and Budget (OMB). Where no amount appears, there was no submission received. Programmed amounts are determined after the end of a fiscal year and reflect the amounts actually available to be spent. Occasionally, a new budget category is established during a fiscal year. When this happens, there will be a programmed amount but no budget request for that budget category. Funds for these activities often were transferred from another project's budget through a "reprogramming" of funds during the year. All amounts come from the annual budget requests prepared by the NASA Office of the Chief Financial Officer.

Earth Science and Applications/MTPE Program

NASA's Earth Science and Applications/MTPE program was responsible for broad space-based and airborne scientific studies of Earth as an integrated whole and studies of the processes that comprise Earth system science. The Agency's interest in Earth sciences began in its early days with the development of TIROS-1, the first satellite to observe Earth from the vantage point of space. Over the next two decades, NASA explored the basic feasibility of making useful Earth observations from space and determining whether space systems were reliable enough for continuing use.¹⁶ Nimbus-7, which launched in 1978 and operated into the 1990s, was an especially important mission, offering new capabilities and producing a number of new

¹⁶ John J. McElroy and Ray A. Williamson, "The Evolution of Earth Science Research from Space: NASA's Earth Observing System," in John M. Logsdon, ed., *Exploring the Unknown, Selected Documents in the History of the U.S. Civil Space Program, Volume VI: Space and Earth Science* (Washington, DC: NASA Special Publication-4407, 2004), pp. 442-443.

measurements, as well as the first view of the Antarctic ozone hole from space. Electro-optical imaging sensors with varying resolutions and spectral characteristics observed Earth, and sounding instruments produced vertical profiles of the atmosphere from polar-orbiting and geosynchronous satellites. In addition, NASA cooperated with NOAA and the international community on research programs focusing on Earth's environment. It also joined other organizations in observing ozone depletion in the upper atmosphere and attempting to determine its cause.¹⁷

The Agency's focus on Earth system science began with a 1982 NASA-initiated report that established the initial scientific basis for studying Earth's physical, chemical, and biological systems in an integrated fashion. Centering on global change, this report raised the question of how human activities might be altering these systems and affecting Earth's habitability.¹⁸ It also addressed the principal scientific ideas that would lead to the idea for the MTPE program in the next decade.

The issue of global habitability was of interest worldwide. At the United Nations Unispace II Conference in Vienna in August 1982, the United States proposed an international cooperative research effort to obtain data from space and by other means relating to changes in Earth's environment that could affect its ability to sustain human life. Although President Ronald

¹⁷ McElroy and Williamson, in Logsdon, pp. 445–446.

¹⁸ Richard Goody, chairman, Workshop Executive Committee, "Global Change: Impacts on Habitability, A Scientific Basis for Assessment," 7 July 1982, cited in John M. Logsdon, ed., *Exploring the Unknown, Selected Documents in the History of the U.S. Civil Space Program, Volume VI: Space and Earth Science*, pp. 477–497.

Reagan was not yet ready to support the initiative, scientists continued to explore the scientific concept of an interdisciplinary approach to Earth science.¹⁹

In May 1986, the NASA Advisory Council issued a report that influenced the design of both NASA's future MTPE program and the future U.S. Global Change Research Program (USGCRP). It called for NASA to collaborate with NOAA, the National Science Foundation (NSF), and other federal agencies on a series of specialized space research missions to study specific Earth system processes, an interdisciplinary program of basic Earth system research, an advanced information system to process the data obtained, and a program of instrument development. It also called for an Earth observing system of polar-orbiting and advanced geostationary space platforms as well as additional specialized space research missions.²⁰ This report and one that followed were instrumental in initiating a major new thrust in Earth science, as well as a proposed 10-year program that would cost \$17 billion and use the Space Shuttle to launch polar-orbiting platforms—an ambitious idea that “proved problematic.”²¹ The committee also listed measurements of specific substances, variables, and properties that should be obtained to achieve the goals stated in the report.

Even before these reports were published, NASA began planning for a major Earth science research program. The Earth Science and Applications Division formed the EOS Science and Mission Requirements Working Group (SMRWG), which arrived at specific goals, processes, and a conceptual research payload. This payload became the initial EOS payload and led to

¹⁹ McElroy and Williamson, in Logsdon, pp. 447–448.

²⁰ The report also listed the precise responsibilities of NASA, NOAA, and the NSF. Earth System Sciences Committee, NASA Advisory Council, “Earth System Science Overview,” May 1986, cited in Logsdon, ed., pp. 536–562.

²¹ McElroy and Williamson, in Logsdon, pp. 449–450.

development of a plan for two large Earth-orbiting platforms (see discussion of EOS later in this chapter).²² Around the same time, the NASA Space Studies Board of the National Research Council conducted its own studies of the types of space-based measurements needed and how they would fit into other Earth science research.²³

In January 1989, outgoing President Reagan announced a new presidential initiative for FY 1990: USGCRP—an interagency research and observation effort coordinated by the Committee on Earth and Environmental Sciences through the Office of Science and Technology Policy. When President George H. W. Bush took office, he reaffirmed the initiative, and the U.S. Congress codified the program by passing the Global Change Research Act of 1990.²⁴ The USGCRP addressed fundamental questions regarding changes in global climate and environmental processes in order to “monitor, understand, and ultimately predict” the nature of global changes and the mechanisms causing them.²⁵

MTPE was the largest element of the USGCRP. It was also an integral part of the International Earth Observing System (IEOS), in which satellites and instruments from the United States, Europe, Japan, and Canada were closely coordinated to provide complementary data on various aspects of Earth’s environment.²⁶ MTPE included near-term flight missions, the Earth Probes program, in situ and aircraft observations, research and analysis programs, a comprehensive data

²² McElroy and Williamson, in Logsdon, p. 451.

²³ McElroy and Williamson, in Logsdon, p. 454.

²⁴ National Research Council, *A Review of the U.S. Global Change Research Program and NASA’s Mission to Planet Earth/Earth Observing System* (Washington, DC: National Academy Press, 1995), p. 6. Also U.S. Congress, *Global Change Research Act of 1990*, Public Law 101-606, November 16, 1990, 101st Congress, 1st sess., <http://www.gcrio.org/gcact1990.html> (accessed March 6, 2006).

²⁵ U.S. Congress, Office of Technology Assessment, *Global Change Research and NASA’s Earth Observing System*, OTA-BP-ISC-122 (Washington, DC: U.S. Government Printing Office, November 1993), p. 1.

²⁶ *Aeronautics and Space Report of the President, Fiscal Year 1993 Activities* (Washington, DC: National Aeronautics and Space Administration, [no date]), p. 58.

system, interdisciplinary science and modeling efforts, an education program, and EOS. These activities involved not only NASA but also scientific and governmental organizations from around the world working together.²⁷

The name “Mission to Planet Earth” was popularized in a 1987 report on future directions for the U.S. civil space program written by a commission led by former astronaut Sally Ride.²⁸ In July 1989, President Bush, marking the 20th anniversary of the Apollo 11 Moon landing, endorsed MTPE.²⁹ In its resolution commemorating the Apollo mission, the Senate Subcommittee on Science, Technology, and Space also called for “the expeditious development of the global environmental program envisioned as the ‘Mission to Planet Earth.’”³⁰

The idea of a mission to planet Earth, and the concept of looking at Earth as NASA looked at other planets, were furthered by the December 1990 “Report of the Advisory Committee on the Future of the U.S. Space Program” prepared by a team of experts chaired by Dr. Norman Augustine.³¹ Vice President-elect Al Gore also heralded it in a 1991 pre-election campaign book titled *Earth in the Balance*, which announced NASA’s new mission as a “mission to planet

²⁷ *Aeronautics and Space Report of the President, Fiscal Year 1991 Activities* (Washington, DC: National Aeronautics and Space Administration, 1992), p. 21.

²⁸ Sally Ride, *NASA Leadership and America's Future in Space, A Report to the Administrator* (Washington, DC: National Aeronautics and Space Administration, August 1987), pp. 23–25. According to an Announcement of Opportunity for MTPE research issued in 1997, “the Mission to Planet Earth (MTPE) program was conceived almost a decade ago, in an era of growth in funding for global environmental research.” Appendix A, Introduction to the NASA MTPE Science Research Plan, http://research.hq.nasa.gov/code_y/nra/current/AO-97-MTPE-01/ApendixA.htm (accessed January 17, 2007).

²⁹ George H. W. Bush, “Remarks on the 20th Anniversary of the Apollo 11 Moon Landing,” July 20, 1989, <http://bushlibrary.tamu.edu/research/papers/1989/89072000.html> (accessed February 14, 2006).

³⁰ Senate Resolution 156, “A Resolution To Express the Sense of the Senate with Respect to the Apollo 11 Lunar Mission, the International Space Station Freedom Program, and the ‘Mission to Planet Earth,’” July 20, 1989, 101st Congress, 1st sess., <http://thomas.loc.gov/cgi-bin/bdquery/z?d101:SE00156:@@L&summ2=m&> (accessed 31 January 2007).

³¹ “Report of the Advisory Committee on the Future of the U.S. Space Program” (Washington, DC: National Aeronautics and Space Administration, December 1990).

Earth.”³² NASA Administrator Goldin called MTPE “a moral commitment to future generations,” citing the need to “understand our environment—separating natural from human causes and effects—so policymakers can make decisions on hard data, not suppositions.”³³

Organizationally, the Office of Mission to Planet Earth was established in 1992 (later becoming the MTPE Enterprise). It focused on five major Earth science disciplines— land surface cover, near-term climate change, long-term climate change, natural hazards research, and atmospheric ozone—and sought to understand the components of the Earth system and their interactions, how they functioned, and how they were expected to change over time.³⁴ Specifically, MTPE committed to measuring 24 global environmental variables in five areas over a 15-year period (see table 2-55).

Phase 1 of MTPE began with the September 1991 launch of UARS. The second phase of MTPE consisted primarily of the EOS program. EOS was designed to provide systematic, continuous observations from low-Earth orbit for a minimum of 15 years to quantify changes in Earth’s system.³⁵

EOS

EOS was a broad program of Earth system science that obtained and analyzed long-term, comprehensive observations from space. It consisted of a planned series of spacecraft carrying a variety of sophisticated instruments to make the most wide-ranging measurements ever taken of

³² Al Gore, *Earth in the Balance: Ecology and the Human Spirit* (Boston: Houghton-Mifflin, 2000).

³³ “Goldin Announces Changes in NASA Organization To Focus and Strengthen Programs and Management,” *NASA News Release 92-172*, October 15, 1992. NASA History Division folder 18429, Historical Reference Collection, NASA Headquarters, Washington, DC.

³⁴ “Mission to Planet Earth Enterprise Name Changed to Earth Science,” *NASA News Release 98-12*, January 21, 1998, <ftp://ftp.hq.nasa.gov/pub/pao/pressrel/1998/98-012.txt> (accessed March 5, 2006).

³⁵ In 1995, NASA changed from the program office structure to the strategic enterprise structure, with MTPE named as one of five strategic enterprises. In 1998, its name was changed to the Earth Science Enterprise (ESE).

the interrelated elements of the global environment. These measurements—along with measurements from other MTPE satellites, ground experiments, and scientific research—enabled scientists to model Earth as a total system, with the goal of assessing how human activity had affected the planet and projecting how it would affect it in the future.

The mission goals of the EOS program were to 1) create an integrated, scientific observing system emphasizing climate change that would enable multidisciplinary studies of Earth's critical, interrelated processes; 2) develop a comprehensive data information system, including a data retrieval and processing system; 3) serve the needs of scientists performing an integrated multidisciplinary study of planet Earth; and 4) acquire and assemble a global database of remote-sensing measurements from space over a decade or more to enable definitive and conclusive studies of Earth's system.³⁶ The priorities for acquiring this data would conform to the four priority environmental science issues identified by the USGCRP as key to understanding global climate change.³⁷ These priorities were to:

- 1) Understand Earth's climate system to improve our understanding of the climate system as a whole, rather than focusing on its individual components, and thus improve our ability to predict climate change and variability
- 2) Investigate the biology and biogeochemistry of ecosystems to improve our understanding of the relationship between a changing biosphere and a changing climate and the effects of global change on managed and natural ecosystems

³⁶ "Science Writers' Guide to Terra," NASA Publication-1999-10-169-GSFC, p. 19, http://www.nasa.gov/pdf/156294main_terra_sw_guide.pdf (accessed November 4, 2005).

³⁷ Michael D. King and Reynold Greenstone, eds., *1999 EOS Reference Handbook; A Guide to NASA's Earth Science Enterprise and the Earth Observing System*, EOS Project Science Office, NASA/Goddard Space Flight Center, NASA Publication-1999-08-134-GSFC, pp. 10–11.

- 3) Assess the composition and chemistry of the atmosphere to improve our understanding of the global-scale effects of natural and human processes on the chemical composition of the atmosphere, and determine the effect of such changes on air quality and human health
- 4) Investigate the global water cycle to improve our understanding of the movement of water through the land, atmosphere, and ocean, and determine how global change may increase or decrease regional water availability.

Planning for the EOS mission began in 1983 when the EOS Science and Mission Requirements Working Group (SMRWG) defined the science and mission requirements. The SMRWG looked particularly at the major Earth science questions for the next decade and the requirements for low-Earth-orbit observations needed to answer these questions on a comprehensive multidisciplinary basis. The direction and definition of the program were further refined by other advisory groups and steering committees, which also offered implementation strategies.

The EOS study project had also been established at Goddard in 1983. During the early study periods, Goddard and the Jet Propulsion Laboratory (JPL) performed mission, data system, and spacecraft studies that resulted in a conceptual design for a dual series of spacecraft missions to satisfy the EOS requirements. These polar-orbiting spacecraft were designated EOS-A and EOS-B, with Goddard and JPL having respective managerial responsibilities.

By the late 1980s, the EOS program had adopted the concept of an integrated Earth system as its scientific thrust. The program had also been included under the broader NASA MTPE initiative, which encompassed other NASA efforts, as well as Earth Probe missions and the Agency's

participation in the International Geosphere Biosphere Program (IGBP) and the World Climate Research Program (WCRP)³⁸ as well.

An announcement of opportunity (AO) for the selection of EOS instruments and science teams was issued in 1988. NASA received 455 proposals in response to the AO. In February 1989, NASA announced the selection of scientific investigations for EOS. The selections were made for three types of investigations: instrument investigations, research facility investigations, and interdisciplinary investigations.³⁹ Early in 1990, NASA announced the selection of 30 instruments to be developed for EOS-A and -B, along with their science teams. In addition, 29 interdisciplinary science investigation teams were selected.

The EOS Investigators Working Group (IWG) was formed in 1989. It consisted of instrument and interdisciplinary principal investigators (PIs) and team leaders to provide scientific advice and guidance for the program. The IWG played a leading role in defining the overall science thrust for the EOS program.

In June 1989, the EOS Non-Advocacy Review (NAR) was held. The program was recognized as part of the presidential initiative MTPE in 1990 and received its “new start” from Congress in October, which allowed it to move on to the execution phase. Responsibility for developing the EOS-A platform was transferred from the Space Station program to the EOS project, and management for all elements of the project became centralized within the EOS project at

³⁸ “Science, Aeronautics, and Technology Fiscal Year 1998 Estimates, Budget Summary, Office of Mission to Planet Earth, Mission to Planet Earth,” <http://www.hq.nasa.gov/office/codeb/budget/mtpe.html> (accessed November 3, 2005).

³⁹ “NASA Announces Earth Observation System Investigations,” *NASA News Release 98-15*, February 8, 1989, NASA History Division electronic record, Historical Reference Collection, NASA Headquarters, Washington, DC.

Goddard.⁴⁰ The EOS program was initially funded under a continuing resolution; it received full funding with approval of the FY 1991 budget in January 1991.

The baseline design consisted of two series of large observatories, EOS-A and EOS-B, in 1:30 p.m. ascending, Sun-synchronous polar orbit, launched by Titan IV ELVs. Each observatory had a five-year life and each was to be replaced twice during the 15-year mission. At the time, the budget through FY 2000 was \$17 billion.⁴¹ Additional instruments were also selected for the proposed Japanese and European polar-orbiting satellites, which at the time were referred to as the Japanese Polar-Orbiting Platform and the European Polar-Orbiting Platform.⁴²

The EOS polar platform had originally been part of the procurement package for the Work Package 3 components of Space Station Freedom awarded to GE Astro Space in 1987 by Goddard. NASA claimed this polar platform would use many of the same systems as the Station and be serviced by the Space Shuttle, although it would reside in a different orbit than the main Station complex. When the Space Station's budget was reduced and Work Package 3 was eliminated in 1990, the joint contract was terminated, and a new contract with GE Astro for the EOS-A platform was written.⁴³ The contract also included an option for a duplicate EOS-A spacecraft; however, this was never exercised.⁴⁴

⁴⁰ "Science, Aeronautics, and Technology Fiscal Year 1998 Estimates, Budget Summary, Office of Mission to Planet Earth, Mission to Planet Earth," <http://www.hq.nasa.gov/office/codeb/budget/mtpe.html> (accessed November 3, 2005).

⁴¹ "Science, Aeronautics, and Technology Fiscal Year 1998 Estimates, Budget Summary, Office of Mission to Planet Earth, Mission to Planet Earth," p. SAT 3-9.

⁴² *1993 EOS Reference Handbook*, NASA Publication-202 (Washington, DC: NASA Earth Science Support Office, 1993), p. 9.

⁴³ "NASA GSFC Active Contract Register," for contract no. NAS5-32500, <http://gsfc-aphrodite.gsfc.nasa.gov/acr/acrcontract.cfm> (accessed 21 March 2006).

⁴⁴ Telephone conversations with Kevin Grady, former Terra project manager, March 17, 2006, and James S. King, Contracting Officer, Goddard Space Flight Center, formerly EOS/Terra Observatory Contracting Officer, March 21, 2005.

The EOS-A series was to provide a suite of measurements yielding information on global warming and other critical aspects of global change, including Earth's radiation balance, atmospheric circulation, air-sea interaction, biological productivity, and land-surface properties. It was to be followed by the EOS-B mission, which would provide a suite of measurements related to potential global warming and other critical aspects of global change complementary to those provided by EOS-A. EOS-B would conduct an expanded study of stratospheric ozone, obtaining complete coverage of chemical species and winds, and achieving the first global monitoring of tropospheric chemistry.

The Synthetic Aperture Radar (SAR) investigation, a facilities investigation planned for EOS-B, was identified as a candidate for separate program approval as an independent mission to be flown on a third dedicated spacecraft under the management of JPL. The EOS SAR mission was to monitor global deforestation and its effect on greenhouse gases, soil, snow, canopy moisture, and flood inundation, explore their relationship to the global hydrologic cycle, and assess sea ice properties and their effect on polar heat flux.⁴⁵

Over the next several years, the EOS program underwent several restructurings and rescopings. The first began in 1991 when NASA restructured and reduced the scope of the program as directed by congressional appropriations committees to adapt to potential funding constraints and to take advantage of new launch opportunities.

⁴⁵ McElroy and Williamson, in Logsdon, p. 458. Also *1991 EOS Reference Handbook*, Goddard Space Flight Center, p. 33.

In July 1991, an EOS External Engineering Review (EER) committee convened in La Jolla, California. NASA and selected Interdisciplinary Science Investigation Principal Investigators (PI) briefed the EER committee on the congressional constraints, their opinions regarding reconfiguration, and options to be considered. The EER committee endorsed options for an EOS containing a “favorable measure of resiliency.”⁴⁶ In August 1991, NASA discussed payload options at the Seattle EOS Instrument Working Group (IWG) meeting. In October, a formal review was conducted by the EOS Payload Advisory Panel in Easton, Maryland. This body, consisting of the EOS Interdisciplinary Science Investigation PIs, was formally charged with examining and recommending EOS payloads to NASA based on the scientific requirements and priorities established by the Earth science community at large. Concurrently, extensive engineering studies were conducted at Goddard to determine the most effective spacecraft configurations to accommodate the instruments on smaller platforms. The studies recommended that EOS be reconfigured to fly the 17 instruments required for the global climate change studies. The overall system would include three series of spacecraft: intermediate spacecraft (EOS-AM, EOS-PM, and EOS-CHEM) to be launched on intermediate ELVs, one smaller spacecraft (COLOR) to be launched on a medium ELV, and two small spacecraft (AERO-1 and AERO-2) to be launched on small ELVs (see figure 2-4). Attached payloads for Space Station *Freedom* were no longer included. In December 1991, the NASA Administrator reviewed and approved the restructured program.⁴⁷

⁴⁶ The report of the EER committee is partially reprinted in Logsdon, pp. 566–575.

⁴⁷ 1993 *EOS Reference Handbook*, p. 10.

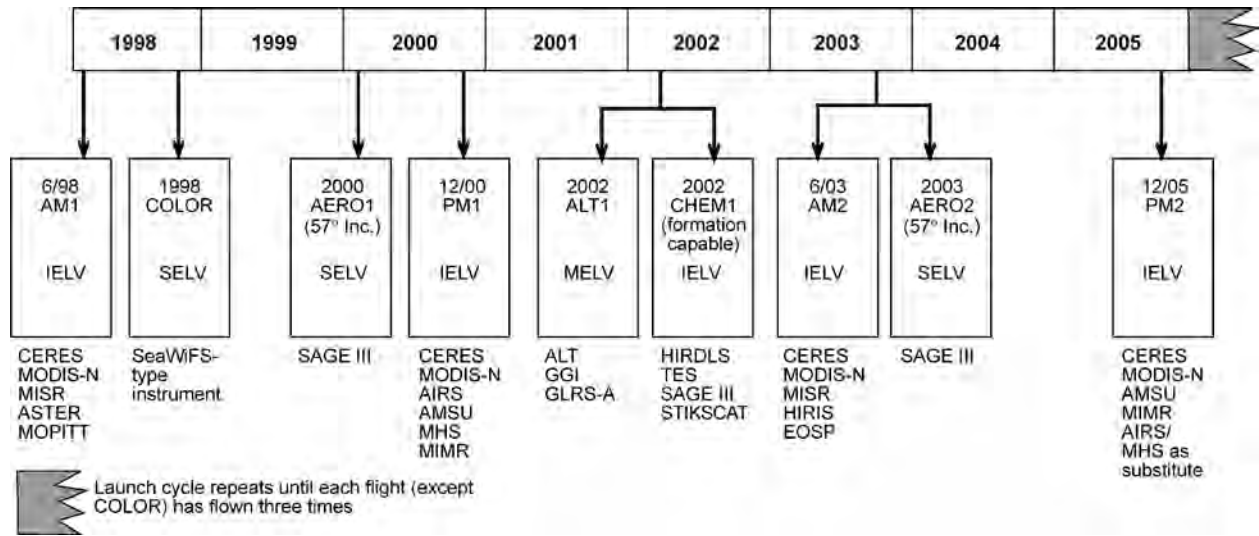

Figure 2-4. Restructured EOS launch profile, March 1992.

On 9 March 1992, NASA submitted its report on the restructuring of EOS to the House and Senate appropriations committees. Congress endorsed the report as being both comprehensive and fiscally responsible, with the final payload configurations for the restructured EOS satisfying all congressional constraints.⁴⁸ As a result of the restructuring, 17 EOS instruments were to fly on a number of small and intermediate spacecraft before 2002 rather than on larger platforms, a reduction of seven instruments. The missions would launch on smaller ELVs in place of Titan IV launch vehicles. NASA dropped the measurement of mesospheric and ionospheric chemistry and solid earth processes. Instead, the Agency adopted the “a.m./p.m.” concept, permitting the study of daily variations.⁴⁹ EOS-AM would be a “morning” satellite, having a descending equatorial crossing time in the morning, while EOS-PM would be an “afternoon” satellite, having an afternoon equatorial crossing time. Along with reducing the number of instruments, NASA

⁴⁸ 1993 EOS Reference Handbook, p. 10.

⁴⁹ U.S. General Accounting Office, *Earth Observing System: Cost and Research Issues, Testimony Before the Committee on Science, House of Representatives*, GAO/T-NSIAD-96-116, March 6, 1996, p. 2, NASA History Division folder 156355, Historical Reference Collection, NASA Headquarters, Washington, DC. Also available at <http://archive.gao.gov/papr2pdf/156355.pdf>.

reduced overall EOS development costs from \$17 billion to \$11 billion through FY 2000 primarily by focusing the mission on global climate change and altering the development schedule. NASA was also to integrate Earth remote-sensing activities with the Department of Energy (DOE) and DOD.⁵⁰

In June 1992, the National Space Council, chaired by Vice President Dan Quayle, issued National Space Policy Directive 7, which covered the space-based elements of the U.S. Global Change Research Program.⁵¹ The document directed NASA to implement the restructured EOS program as part of an overall space-based global-change observation system.

In October 1992, the FY 1993 appropriations bill passed by Congress reduced the budget for EOS through FY 2000 to \$8 billion, forcing NASA to further reconfigure EOS. Rescoping studies had already begun soon after the restructured EOS program had been endorsed by Congress. As part of an internal review of all major programs, NASA Administrator Goldin established “red” and “blue” teams in May 1992 to review program content, schedule, and cost. He also set a 30 percent reduction in budget as a target (from \$11 billion to \$8 billion). NASA Headquarters carefully considered the input of the teams and the EOS Payload Advisory Panel to arrive at the rescoped payloads.⁵² The rescoping was done without significant changes to the scientific complement. The program adopted a common spacecraft for all but the EOS AM-1 mission, adopted a cost-driven approach to instrument development, reduced the number of data products required before launch, deleted one instrument, and relied more on other Agency and

⁵⁰ *Aeronautics and Space Report of the President, Fiscal Year 1992 Activities* (Washington, DC: National Aeronautics and Space Administration, 1993, p. 46). Also *1993 EOS Reference Handbook*, p. 10; King and Greenstone, eds., *1999 EOS Reference Handbook*, pp. 17–18.

⁵¹ *Space-Based Global Change Observation, NSPD-7*, May 28, 1992, <http://www.fas.org/spp/military/docops/national/nspd7.htm> (accessed March 6, 2006).

⁵² *1993 EOS Reference Handbook*, p. 11.

international partners to meet some scientific requirements by flying international instruments.⁵³ Program contingency funds were also reduced. It was believed that with the instruments being flown in five-year cycles, any problems that were discovered could be handled in the next version of the instrument.⁵⁴

In the fall of 1994, the EOS program was redesigned once more to respond to a reduced program budget. In response to federal budget constraints, the Agency took several steps to trim the EOS and EOSDIS budget through FY 2000 by approximately \$750 million (9 percent) to a total of \$7.25 billion.⁵⁵ NASA's objectives were to preserve the scientific integrity of EOS as a global-change program and to maintain the target launch schedule for core EOS missions. Realigning the EOS program meant relying more on both domestic products and measurements. Some high-priority scientific items were added to the program or scheduled sooner, such as the flight of an additional SAGE instrument in 2000 and the incorporation of a Landsat-type instrument on the EOS AM-2 spacecraft. The redesign removed three instruments from the CHEM-1 mission and moved one instrument from the AM-2 mission to CHEM-1. Additionally, Landsat 7 was added to the EOS program, and EOS COLOR was canceled; the EOS-Altimetry mission was split into Laser and Radar components, and the Radar Altimetry segment was cost-capped.⁵⁶ In September

⁵³ *Aeronautics and Space Report of the President, Fiscal Year 1992 Activities*, p. 46. Also King and Greenstone, eds., *1999 EOS Reference Handbook*, pp. 17–18.

⁵⁴ *1993 EOS Reference Handbook*, pp. 11–12.

⁵⁵ King and Greenstone, eds., *1999 EOS Reference Handbook*, p. 18. Also GAO, *Earth Observing System: Cost and Research Issues*, March 6, 1996, NASA History Division folder 156355, Historical Reference Collection, NASA Headquarters, Washington, DC. Also at <http://archive.gao.gov/papr2pdf/156355.pdf>.

⁵⁶ King and Greenstone, eds., *1999 EOS Reference Handbook*, p. 18. David P. Radzanowski and Stephen J. Garber, *An Overview of NASA's Mission to Planet Earth (MTPE)*, CRS Report for Congress, 95-312 SPR, March 1, 1995, pp. CRS-3-CRS-4, NASA History Division folder 005704, Historical Reference Collection, NASA Headquarters, Washington, DC.

1994, NASA released a major solicitation seeking proposals for a “common” spacecraft bus for several of the subsequent EOS flights, with selection expected in 1995.⁵⁷

During the spring and summer of 1995, NASA focused on a series of important reshaping exercises for MTPE and EOS designed to chart the long-term implementation plans for the program while staying below the cost cap. In April 1995, Congress asked the National Academy of Sciences to review the MTPE/EOS program. Several study teams examined various ways to preserve the 24 science measurements while further reducing the system’s cost. This effort showed that the program could meet a long-term budget cap of \$1 billion per year while maintaining the basic 24 measurements sets. To achieve this, it was proposed that the initial satellite in each EOS series be built as planned while succeeding satellites would be built smaller and at a lower cost using new technology developed under the New Millennium Program (NMP)—NASA’s cross-enterprise technology demonstration and infusion program. The process also proposed a third series of missions termed “continuity missions” also featuring missions from NMP. Earth System Science Pathfinder (ESSP)—concepts that would allow rapid deployment of new science instruments—was also proposed.⁵⁸

In September 1995, the National Academy of Sciences’ Board on Sustainable Development released a strong scientific endorsement of EOS. The board concluded that MTPE should proceed with near-term EOS missions “without delay” and urged MTPE to continue infusing new cost-saving science and technology into later elements of the program. The board also

⁵⁷ *Aeronautics and Space Report of the President, Fiscal Year 1994 Activities* (Washington, DC: National Aeronautics and Space Administration, 1995), p. 56.

⁵⁸ King and Greenstone, eds., *1999 EOS Reference Handbook*, p. 18. Also “The Earth Observing System: Understanding Planet Earth,” NASA Facts Online, [http://www.gsfc.nasa.gov/gsfcservice/gallery/fact_sheets/earthsci/fs-96\(06\)-009.htm](http://www.gsfc.nasa.gov/gsfcservice/gallery/fact_sheets/earthsci/fs-96(06)-009.htm) (accessed March 7, 2006).

recommended that NASA transfer responsibility for information product generation, publication, and user services to a federation of partners selected through an open competitive process. With participation from the external research community, NASA began a study of the best approaches to implement these recommendations.⁵⁹

Also in September 1995, NASA awarded a \$398.7 million contract to TRW, Inc., for the EOS Common Spacecraft, which would be used for the EOS-PM-1 and EOS-CHEM missions. The contract was for two spacecraft with separate options for two additional spacecraft. TRW, Inc. would design, fabricate, integrate, test, deliver, and provide launch support and flight operations support for the spacecraft. EOS PM-1 was to focus on climate-related measurements of Earth's atmosphere, cloud cover, precipitation, terrestrial snow cover, and sea ice. EOS CHEM-1 was to measure a variety of chemicals in Earth's atmosphere.⁶⁰

In 1996, NASA initiated three efforts designed to help the future evolution of MTPE. First, NASA expanded implementation of NMP. In the spring of 1996, MTPE managers selected the first Earth-orbiting NMP mission, the Earth Observing (EO)-1, which would demonstrate an advanced land imager system and hyperspectral imaging technologies incorporating several innovative design features.⁶¹ The mission was planned to launch in 2000. Second, MTPE began the ESSP program to expedite the acquisition of key scientific data. The program would

⁵⁹ *Aeronautics and Space Report of the President, Fiscal Year 1995 Activities* (Washington, DC: National Aeronautics and Space Administration, [no date]), p. 54. Also National Research Council (NRC), Committee on Global Change Research and Board on Sustainable Development. *A Review of the U.S. Global Change Research Program and NASA's Mission to Planet Earth/Earth Observing System* (La Jolla report) (Washington, DC: National Academy Press, 1995).

⁶⁰ "EOS Contract Highlights NASA's New Business Practices," *NASA News Release 95-186*, September 15, 1995, <http://www.gsfc.nasa.gov/news-release/releases/1995/95-186.txt> (accessed March 6, 2006).

⁶¹ "NASA Will Study Ideas To Transform Earth Observations," *NASA News Release 99-30*, March 2, 1999, <http://www.nasa.gov/home/hqnews/1999/99-030.txt> (accessed February 12, 2007).

accommodate new scientific priorities and infuse new scientific participation into MTPE. The first AOs were issued in July 1996. Third, MTPE conducted a joint workshop with the commercial sector to incorporate industry suggestions into the final version of MTPE's commercial strategy.⁶²

In late 1996, MTPE began the first of a planned series of biennial reviews to assess its planning and implementation of all elements of the MTPE program. The review, completed in the summer of 1997 in time to affect FY 1999 budget planning, helped define a new model for missions following the first EOS series that would have reduced costs and development times. It stressed NASA's goal of making key decisions as late as possible to best take advantage of the most recent science and advanced technology available. It emphasized the philosophy of flexible mission designs that would grow from progress in MTPE's five major science themes: land-cover and land-use change, seasonal climate variability, long-term climate change, atmospheric ozone, and natural hazards such as hurricanes and earthquakes. The program committed to a combination of commercial off-the-shelf spacecraft and "aggressive instrument technology development." It also stressed the need to focus more effort on infusing new technology into the EOS missions to follow the CHEM-1 mission.⁶³

The schedule for the first series of Earth science missions as of March 1999, including the EOS, NMP, and ESSP missions, is illustrated in figure 2-5.

⁶² *Aeronautics and Space Report of the President, Fiscal Year 1996 Activities* (Washington, DC: National Aeronautics and Space Administration, [no date]), p. 60.

⁶³ McElroy and Williamson, in Logsdon, p. 463. Also "Major Review of Mission to Planet Earth Endorses Flexible Approach to Future Satellites, Steers Data System Development," *NASA News Release 97-180*, August 21, 1997, <ftp://ftp.hq.nasa.gov/pub/pao/pressrel/1997/97-180.txt> (accessed March 9, 2006).

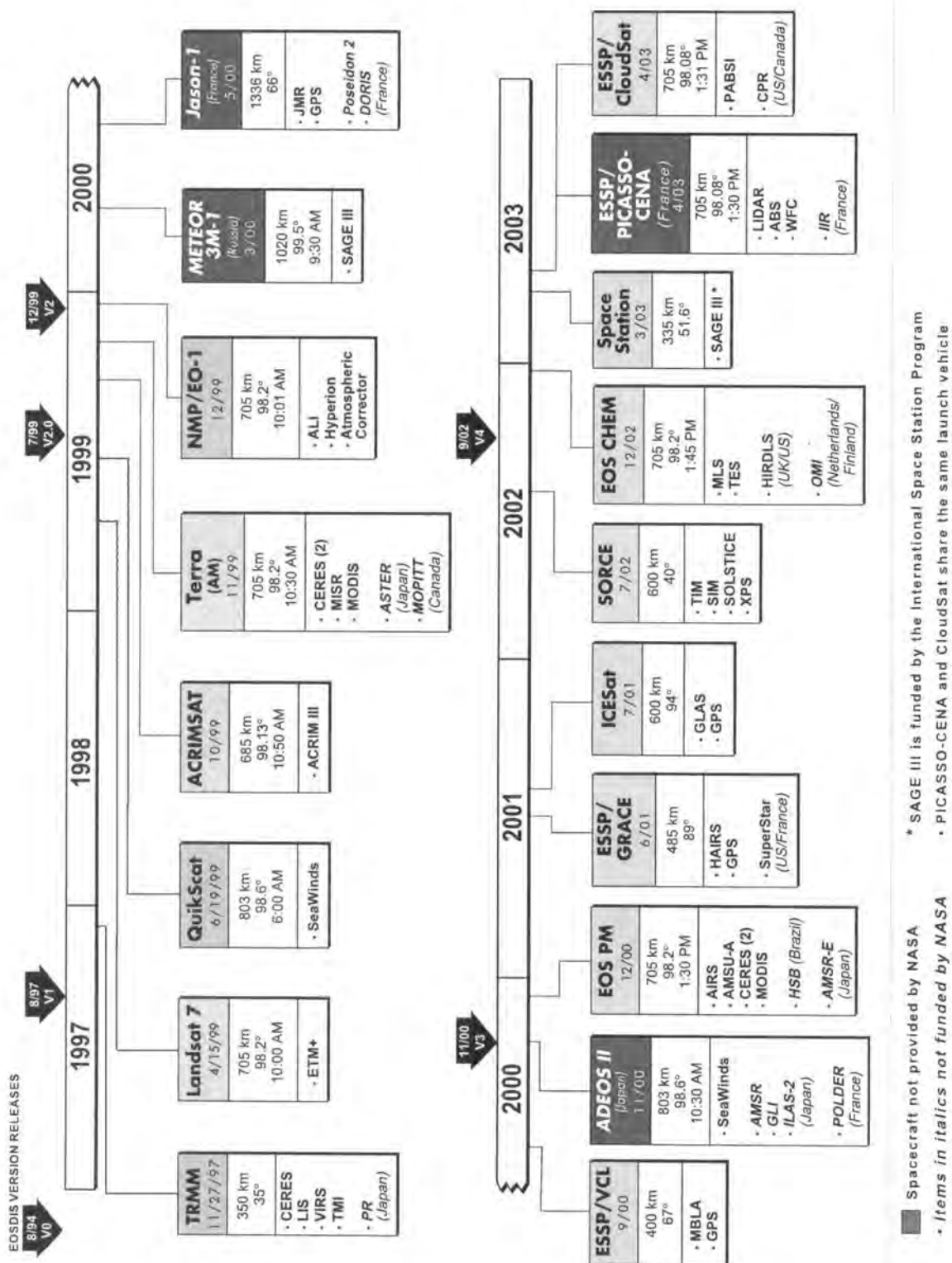

Figure 2-5. Earth Science mission profile 1999 (1999 EOS Reference Handbook).

At the end of August 1998, EOS AM-1 reached a critical milestone when the last science instrument for the spacecraft was delivered, allowing completion of module testing and integration of the instruments and spacecraft at the Lockheed Martin production facility in Valley Forge, Pennsylvania. After testing was completed, the spacecraft was delivered to Vandenberg Air Force Base for launch processing.⁶⁴

Launch of EOS AM-1 was originally planned for mid-1998, but because of performance problems with ground system software required to control, monitor, and schedule science activities on the spacecraft, NASA postponed its launch in April 1998.⁶⁵ In February 1999, the launch date for the newly renamed Terra was set for July 15, 1999; however, launch was delayed again until December 18, 1999, when Terra was finally sent into a polar, Sun-synchronous 705-kilometer (438-mile) orbit. Terra had a descending equatorial crossing time of 10:30 a.m.; at this time the daily cloud cover was typically at a minimum over land, and thus surface features could be more easily observed.

EOS PM-1 (renamed Aqua) launched in 2002, followed by EOS CHEM-1 (AURA) in 2004. Additional observations were to be provided by Landsat 7, launched in April 1999, and several other missions.⁶⁶

The Terra spacecraft consisted of a spacecraft platform provided under contract with Lockheed Martin Missiles and Space and five instruments procured under contracts with U.S. and

⁶⁴ “Major Earth Science Spacecraft Reaches Critical Milestone, *NASA News Release 97-195*, August 28, 1997, <ftp://ftp.hq.nasa.gov/pub/pao/pressrel/1997/97-185.txt> (accessed March 8, 2006).

⁶⁵ “NASA Finds Problems in EOSDIS Flight Operations Software Development,” *NASA News Release 98-60*, April 10, 1998, <ftp://ftp.hq.nasa.gov/pub/pao/pressrel/1998/98-060.txt> (accessed March 7, 2006).

⁶⁶ “Science Writers’ Guide to Terra,” 19, http://terra.nasa.gov/Publications/terra_sw_guide.pdf (accessed February 13, 2006).

international corporations (see figure 2-6). Raytheon (formerly Hughes Santa Barbara Remote Sensing [SBRS]) built the Moderate Resolution Imaging Spectroradiometer (MODIS) under contract to Goddard, TRW provided the Clouds and Earth's Radiant Energy System (CERES) instrument, and the Multi-Angle Imaging Spectro-Radiometer (MISR) instrument was built at JPL.⁶⁷ Japan provided the Advanced Spaceborne Thermal Emission and Reflection Radiometer (ASTER), which was built by Mitsubishi Electronics Company and Fujitsu, Ltd., and Canada provided the Measurement of Pollution in the Troposphere (MOPITT) instrument, which was built by COM DEV International.⁶⁸

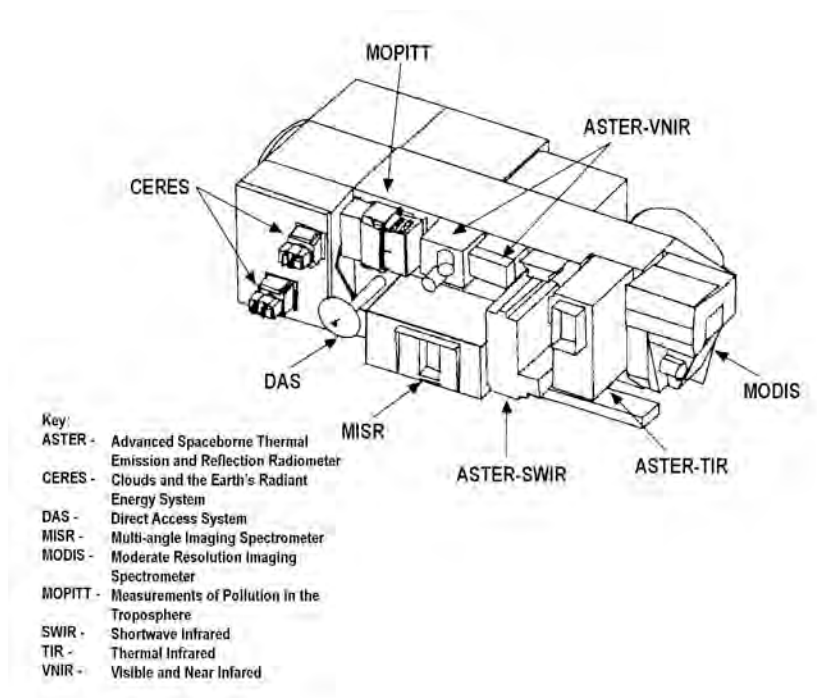

Figure 2-6. Terra (EOS AM-1) platform and instruments (1999 EOS Reference Manual).

⁶⁷ CERES was also flown on the TRMM in 1997 and on the PM series spacecraft as a flight of opportunity.

⁶⁸ "Science, Aeronautics, and Technology Fiscal Year 1998 Estimates, Budget Summary, Office of Mission to Planet Earth, Mission to Planet Earth," <http://www.hq.nasa.gov/office/codeb/budget/mtpe.html> (accessed November 3, 2005). Also "Terra: Flagship of the Earth Observing System," Press Kit, November 1999, p. 4, http://terra.nasa.gov/Publications/terra_press_kit.pdf (accessed March 7, 2006).

The spacecraft was constructed with a truss-like primary structure of graphite epoxy tubular members. This lightweight structure provided the strength and stiffness needed to support the spacecraft throughout its mission phases. The zenith face of the spacecraft housed equipment modules (EMs) containing the spacecraft bus components. The EMs were sized and partitioned to facilitate prelaunch integration and test of the spacecraft. A large single-wing solar array was deployed on the sunlit side of the spacecraft. Locating the array on this side maximized both its power-generation capability and the cold-space field of view available to instrument and equipment module radiators. A steerable high-gain antenna and associated electronics were mounted on a deployed boom extending from the zenith side of the spacecraft. This location maximized the amount of time available for communications with the Tracking and Data Relay Satellite System (TDRSS) via this antenna without obstruction by other parts of the spacecraft. All instruments were mounted on the nadir-facing deck of the spacecraft for a clear view of Earth.⁶⁹

Terra's instruments operated by gathering sunlight that was reflected by Earth or heat emitted by Earth. This energy was focused on specially designed detectors sensitive to selected regions of the electromagnetic spectrum, ranging from visible light to thermal infrared light.⁷⁰ The science data generated by each instrument was sent to the spacecraft over high-bandwidth communication lines. These data were multiplexed and recorded in a solid-state recorder and then sent to the communication subsystem for transmission to the ground, where they were processed into images by computers. The solid-state recorder was designed to hold approximately two orbits of data, up to 140 gigabytes.

⁶⁹“Terra (EOS AM-1),” <http://library01.gsfc.nasa.gov/gdprojs/projinfo/terra.pdf> (accessed March 8, 2006). Also “EOS AM-1: The First EOS Satellite, NASA’s Earth Observing System,” NASA Publication NP-1998-03-018-GSFC.

⁷⁰“Terra: Flagship of the Earth Observing System,” Press Kit, p. 12, http://terra.nasa.gov/Publications/terra_press_kit.pdf (accessed March 7, 2006).

Two communications capabilities were available for transmission to the ground. First, data was transmitted via the TDRSS on Ku-band to the TDRSS Ground Station at White Sands, New Mexico. Second, data were transmitted directly to the ground using the Direct Access System, which was composed of the Direct Playback, the Direct Broadcast, and the Direct Downlink subsystems. This backup option could transmit via an X-band transmitter should the satellite lose its TDRSS link.⁷¹ In both cases, transmission was scheduled to occur at specific times based on the availability of TDRSS or the proximity of a ground station. Continuous direct broadcasts of MODIS data were available on X-band and could be received by individuals around the world.

The guidance, navigation, and control subsystem maintained the pointing accuracy of the spacecraft to within 150 arc seconds of the desired pointing direction and determined pointing to within 90 arc seconds using star trackers. Additionally, this subsystem provided safhold control in the event of a spacecraft operational anomaly.⁷²

The spacecraft design supported an instrument mass of 1,155 kilograms (2,546 pounds), an average power for the spacecraft and instruments of 2.5 kilowatts, and an average data rate of 18 Mbps (109 Mbps peak).⁷³ The global climate change research emphasized by Terra included cloud physics, atmospheric radiation properties, and terrestrial and oceanic characteristics.⁷⁴ Table 2-56 lists the measurements provided by the Terra instruments. See table 2-57 for further information.

⁷¹ King and Greenstone, eds., *1999 EOS Reference Handbook*, p. 76.

⁷² “EOS AM-1: The First EOS Satellite, NASA’s Earth Observing System,” 22.

⁷³ King and Greenstone, eds., *1999 EOS Reference Handbook*, pp. 75–76.

⁷⁴ “Science, Aeronautics, and Technology Fiscal Year 1998 Estimates, Budget Summary, Office of Mission to Planet Earth, Mission to Planet Earth,” <http://www.hq.nasa.gov/office/codeb/budget/mtpe.html> (accessed November 3, 2005).

EOS Data and Information System

The MTPE/Earth Sciences Enterprise was strongly committed to making the vast quantity of Earth science data from NASA's Earth science research satellites and field measurement programs easily available and affordable to a wide community of users. Consequently, concurrently with development of EOS, the Enterprise developed the Earth Observing System Data and Information System (EOSDIS), a system for acquiring, archiving, managing, and distributing Earth observation data to diverse users.⁷⁵

EOSDIS was NASA's contribution to the interagency Global Change Data and Information System (GCDIS), a collection of distributed information systems operated by government agencies involved in global-change research. The system had several functions. It managed data acquired from pre-EOS and EOS missions, as well as Earth-Sensing Legacy data, and provided data archiving/distribution and information-management services. It provided the mission-operation systems that commanded and controlled the spacecraft and instruments and monitored health and safety, in addition to performing mission planning and scheduling, initial data capture, and Level 0 data processing.⁷⁶ The system supported the generation of datasets by assimilating satellite and observations into global climate models.⁷⁷ All EOS spacecraft and instruments were commanded by the EOS Operations Center at Goddard.

⁷⁵ "Earth Observing System Data and Information System," <http://spsosun.gsfc.nasa.gov/eosinfo/Welcome/index.html> (accessed February 13, 2006).

⁷⁶ Level 0 data processing consists of instrument science data at full resolution, time ordered, with duplicates and transmission errors removed. "MER [Mars Exploration Rover] Analyst Notebook Users Guide," Washington University citing NASA Planetary Data System, <http://anserver1.eprsl.wustl.edu/anteam/mera/help/index.html?dataprocessinglevel.htm> (accessed January 17, 2007).

⁷⁷ "What Is EOSDIS?" http://spsosun.gsfc.nasa.gov/eosinfo/EOSDIS_Site/index.html (accessed February 13, 2006).

Researchers used Science Computing Facilities (SCFs) ranging from individual workstations to supercomputers to develop algorithms and models to generate data products, access services in EOSDIS, conduct scientific research, and achieve scientific quality control of the data products. Some SCFs supported the planning, scheduling, command and control, and analysis of instrument engineering data. Additionally, each EOS instrument team had its own SCF.

Originally, EOSDIS was designed so that all functions would be centralized at Goddard. Users, however, believed that such an arrangement prevented them from having adequate input into system development. Based on a 1990 report by the EOS IWG, EOSDIS created a system of Distributed Active Archive Centers (DAACs), each with a particular area of expertise in Earth science.

EOSDIS began operating in August 1994 at eight DAACs around the United States and interoperating with six foreign sites (table 2-58).⁷⁸ These DAACs processed, archived, and distributed EOS and EOS-related data and provided a full range of user support. The system-wide EOSDIS Core System (ECS) provided uniform support across all DAACs for these activities. In 1996, an agreement was completed between NASA and the Russian Academy of Sciences Institute for Radioengineering and Electronics to extend EOSDIS to Russia.

Through 1998, two versions of the EOSDIS were in use. EOSDIS Version 0 (V0) was a working prototype with some operational elements. Because this version was put in use before the major EOS missions were launched, satellite data from earlier missions served as a prototype of the

⁷⁸ “An Overview of EOSDIS,” http://spsosun.gsfc.nasa.gov/eosinfo/EOSDIS_Site/Overview.html (accessed January 8, 2006).

data that would be gathered by the EOS spacecraft. This initial version interconnected existing Earth science data systems via electronic networks, interoperable catalogs, and common data-distribution procedures to improve access to existing and pre-EOS data. It did not have all the capabilities, fault tolerance, or reliability of later versions, but could support use by the scientific community in day-to-day activities. Development of V0 had been initiated in 1991 as a collaboration among the Earth Science Data and Information System Project, the DAACs, and the NOAA Satellite Active Archive (SAA). It became operational in August 1994.

The Goddard and Langley DAACs extended V0 to Version 1 (V1), which has provided full support to TRMM since it was launched in November 1997.

Version 2.0 was ready in March 1999 to provide early-orbit support for Landsat 7. It was augmented to be cable of providing early-orbit support for Terra by July 1999, and was providing full support for Landsat 7 and Terra by December 1999. Its functions included spacecraft command and control, data capture and backup archiving, and the production of at-launch standard products. Version 2.0 also supported quality assessment of these products at the SCFs, and their archiving and distribution to users.⁷⁹

Data from the Terra spacecraft flowed via TDRSS to the TDRSS ground terminals in White Sands, New Mexico, where the data were captured and recorded at 150 Mbps. The data were forwarded via a 45-Mbps communications link to the EOS Data and Operations System (EDOS) at Goddard, where it underwent Level 0 processing. Level 0 datasets for four of the five Terra

⁷⁹ King and Greenstone, eds., *1999 EOS Reference Handbook*, pp. 33–34. Also e-mail from H. K. Ramapriyan, ESDIS Project, to author, February 12, 2007.

instruments (MODIS, CERES, MISR, and MOPITT) were then transferred over the EOS networks to the appropriate DAAC for further processing, using algorithms provided by the Instrument Science Teams. Level 0 data for the ASTER instrument were sent via physical media to the ASTER Ground Data System (GDS) in Tokyo, Japan, for further processing. A set of ASTER Level 1 data products was sent via physical media from the ASTER GDS to the EROS Data Center (EDC), where it was processed to produce higher-level data products.⁸⁰

Teams of scientists worldwide received the data to perform their research. Additionally, EOS data and products were available to all users, without restriction, at no more than the cost of dissemination and regardless of the intended use.⁸¹

SeaWiFS

SeaWiFS was a follow-on ocean color sensor to the Coastal Zone Color Scanner (CZCS), which flew on Nimbus-7 from 1978 to 1986, and a precursor to EOS. It was the only scientific payload aboard the commercially built and operated OrbView-2 satellite (originally called SeaStar), owned by Orbital Sciences Corporation (OSC) (see figure 2-7). OrbView-2 was launched on August 1, 1997, from Vandenberg Air Force Base, California, aboard a Pegasus XL launch vehicle. Data collection began 30 days after launch. SeaWiFS was part of NASA's MTPE (later the Earth Science Enterprise).

⁸⁰ "EOS AM-1: The First EOS Satellite, NASA's Earth Observing System," 23–24.

⁸¹ "EOS AM-1: The First EOS Satellite, NASA's Earth Observing System," 23–24.

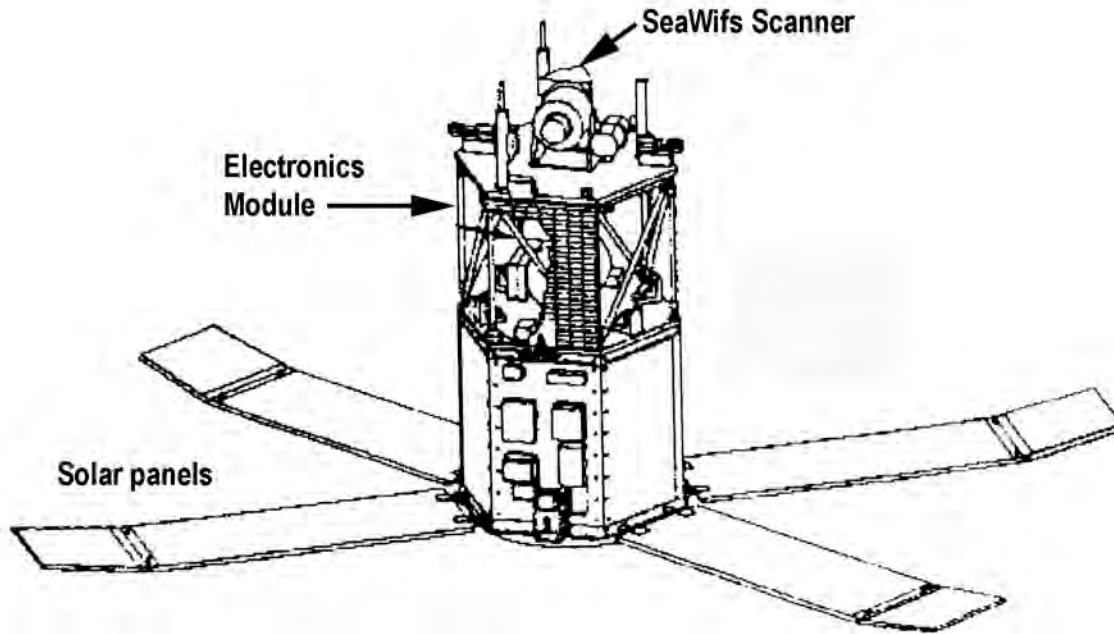

Figure 2-7. SeaStar spacecraft with solar panels deployed (“Sea-viewing Wide Field-of-view Sensor,” NASA Facts Online, FS-97[03]-004-GSFC).

SeaWiFS represented a new way of doing business for NASA. Rather than building, launching, and controlling a satellite to study an important aspect of Earth’s environment, NASA purchased commercially available data acquired from a privately built satellite and used the data for environmental research. NASA’s SeaWiFS project specified the data it wanted to purchase, and the owner of the satellite retained the rights to sell the data to other clients.⁸²

Because the earlier CZCS had an anticipated two-year design life, planning for a replacement ocean color sensor began in the early 1980s. After considering a number of options during the 1986–1989 period for maintaining continuity of ocean color data (including “piggybacking” on

⁸² “First Global Ocean-Color Images From New Sensor Show Promise for Climate, Biological Studies,” *NASA News Release 97-211*, 23 September 1997, <ftp://ftp.hq.nasa.gov/pub/pao/pressrel/1997/97-211.txt> (accessed January 23, 2006). Also *Aeronautics and Space Report of the President, Fiscal Year 1991 Activities*, p. 24. “Mission to Planet Earth: Understanding Our Changing Planet,” February 7, 1994, NASA History Division folder 16434, Historical Reference Collection, NASA Headquarters, Washington, DC.

Landsat 6), NASA, Hughes Santa Barbara Remote Sensing, and OSC explored a stand-alone “lightsat” solution for the mission that would be as commercially oriented as possible. This process led to a competitive procurement for an ocean color data stream in which NASA would pay in advance for data to be provided later to the scientific community. The cost of \$43.5 million for the data was generally considered to be lower than what would be required for NASA itself to develop and field the system. The commercial sale of the data would recoup additional costs. In March 1991, NASA selected OSC to build the spacecraft. In May 1991, OSC contracted with Hughes to build the SeaWiFS instrument. It was completed and ready for delivery 24 months later, an exceptionally short time.

Tests at the time revealed that the instrument specifications had failed to include an important requirement desired by the science community, resulting in the sensor having a significantly higher off-axis response that would degrade the scientific usefulness of the data. Although OSC and Hughes were under no obligation to do so since this was a firm fixed-price contract, the two companies modified the instrument at their own expense to improve its performance to satisfy the science community. Hughes delivered the modified and retested instrument to OSC for spacecraft integration in December 1993. However, OSC encountered problems with spacecraft development and the Pegasus launch vehicle, causing the launch to be delayed until August 1997—more than three years after instrument delivery.⁸³

The primary objective of the SeaWiFS project was to distribute SeaWiFS data to scientists conducting research into the role of oceans in cycling carbon throughout Earth’s land, sea, and

⁸³ Committee on Earth Studies, Space Studies Board, *The Role of Small Satellites in NASA and NOAA Earth Observation Programs* (Washington, DC: National Academy Press, 2000), pp. 84–87.

life.⁸⁴ The goals of SeaWiFS included determining the size and types of primary production by marine phytoplankton on a global scale and measuring the oceans' role in the global carbon cycle and other bio-geochemical cycles. Other goals were to calibrate the SeaWiFS instrument, develop and validate methods of removing atmospheric effects that could degrade data quality, and develop and validate derived data, such as chlorophyll concentrations and the fluctuation of the amount of light penetrating the oceans. Finally, in preparation for future EOS missions, the scientific and technical experience gained from the SeaWiFS project advanced the applications of ocean color data and the technical capabilities required for processing, managing, analyzing, and distributing large amounts of data.⁸⁵

SeaWiFS data illuminated one of the most poorly understood aspects of climate change. Oceans cover 70 percent of Earth's surface, and SeaWiFS provided information on a large part of the global biosphere. It also provided important information for fisheries and coastal zone management. Additionally, SeaWiFS was useful for viewing plants on land, and its data could be combined with plant productivity data from other satellites (such as Landsat and some weather satellites operated by NOAA) to measure the total global carbon exchange.⁸⁶ During its first year of operation, it provided insights into the impact of El Niño on ocean life and allowed scientists to witness the ocean transition from El Niño to La Niña conditions in the equatorial Pacific, specifically around the Galapagos Islands. The instrument also enabled scientists to observe the remarkable speed with which the ocean returned to its pre-El Niño state, including

⁸⁴ "NASA's Mission to Planet Earth: Space-Based Missions, 1997–2000," NASA Facts Online, Goddard Space Flight Center, http://www.gsfc.nasa.gov/gsfc/service/gallery/fact_sheets/earthsci/mtpe2000.htm (accessed January 23, 2006).

⁸⁵ "Sea-viewing Wide Field-of-view Sensor (SeaWiFS)," NASA Facts Online, FS-97(03)-004-GSFC, http://www.gsfc.nasa.gov/gsfc/service/gallery/fact_sheets/earthsci/seawifs.htm (accessed January 23, 2006).

⁸⁶ "Sea-viewing Wide Field-of-view Sensor (SeaWiFS)," NASA Facts Online, FS-97(03)-004-GSFC, http://www.gsfc.nasa.gov/gsfc/service/gallery/fact_sheets/earthsci/seawifs.htm (accessed January 23, 2006).

unprecedented phytoplankton blooms stretching across the entire basin from the coast of South America to the Western Pacific warm pool.⁸⁷

SeaWiFS could view the world's oceans every two days. The SeaWiFS Data Processing System (SDPS) received approximately 381 megabytes of science data per day and generated science data products totaling up to three gigabytes (3,000 megabytes) per day. The SDPS computers were sized to perform preliminary data processing within 24 hours of collection and could reprocess the same data using additional information to increase the accuracy when required.

SeaWiFS produced two types of science data: local area coverage (LAC) and global area coverage (GAC). The LAC provided coded data collected from the local area under the spacecraft's flight path within a 1,500-mile (2,414-kilometer) swath, with three quarters of a mile (1.2 kilometers) as the smallest visible area. The data was coded for security and transmitted continuously when the satellite was in daylight. The GAC provided global coverage at 2.5-mile (4-kilometer) ground resolution. Every fourth LAC sample was stored on board the spacecraft to produce the GAC. These data were transmitted to a ground station at NASA's Wallops Flight Facility, Wallops Island, Virginia, every 12 hours. The permanent data archive resided at Goddard's EOSDIS DAAC. The data archive was planned to reach a storage capacity of six terabytes over the life of the mission.⁸⁸ Users also could access the archive electronically and receive SeaWiFS data at reproduction costs.⁸⁹

⁸⁷ "SeaWiFS Completes a Year of Remarkable Earth Observations," *NASA News Release 98-170*, September 17, 1998, <ftp://ftp.hq.nasa.gov/pub/pao/pressrel/1998/98-170.txt> (accessed February 28, 2006).

⁸⁸ A terabyte is equal to 1,000 gigabytes.

⁸⁹ "Sea-Viewing Wide Fields of View Sensor (Sea-WiFS)," *NASA Facts On-Line, FS-97 (03)-004-GSFC*, http://www.gsfc.nasa.gov/gsfcservice/gallery/fact_sheets/earthsci/seawifs.htm (accessed January 23, 2006).

NASA led an international group of more than 800 scientists representing 35 countries who registered to use SeaWiFS data. More than 50 ground stations worldwide received data from the spacecraft.⁹⁰

Figure 2-8 shows a schematic of the SeaWiFS scanner assembly. See table 2-59 for further mission information.

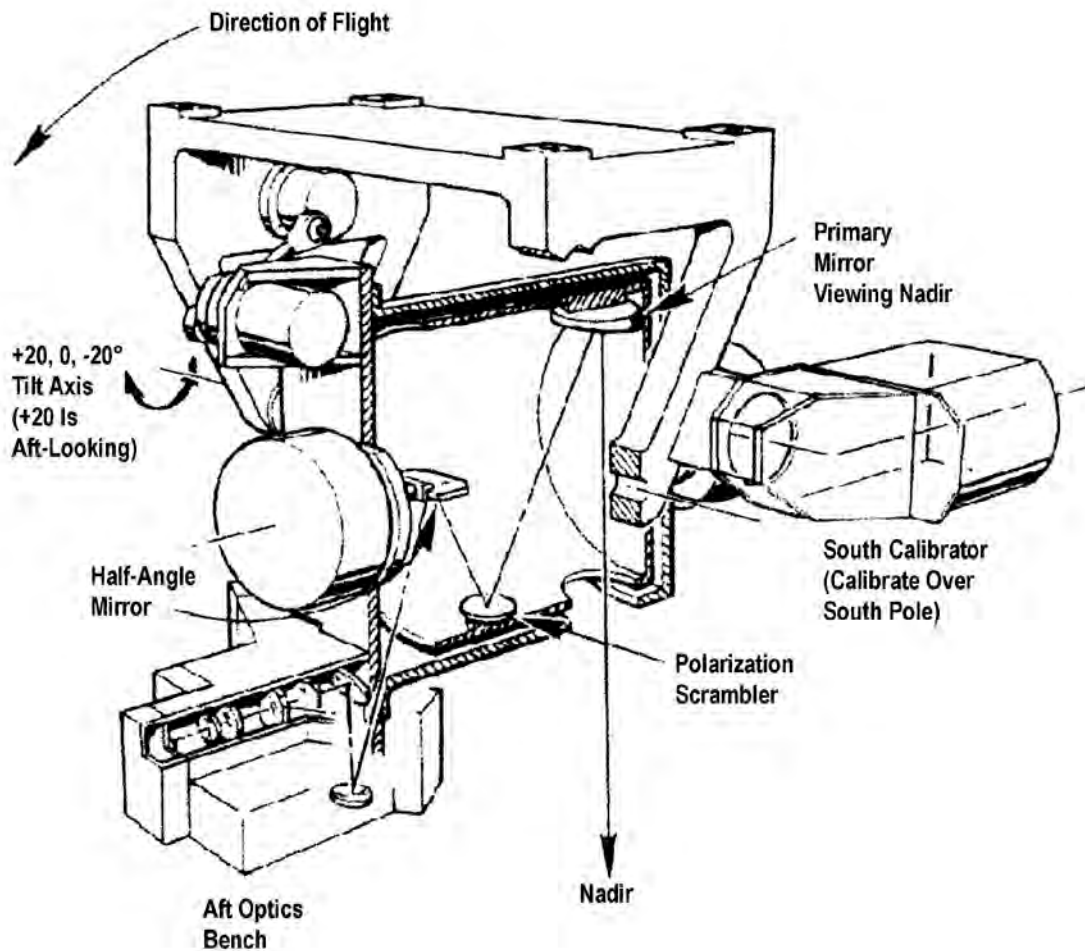

Figure 2-8. The SeaWiFS scanner assembly scans from west to east (“An Overview of SeaWiFS and the SeaStar Spacecraft,” NASA-GSFC).

⁹⁰ “SeaWiFS Completes a Year of Remarkable Earth Observations,” *NASA News Release 98-170*, September 17, 1998, <ftp://ftp.hq.nasa.gov/pub/pao/pressrel/1998/98-170.txt> (accessed February 28, 2006).

Landsat

The Landsat series of spacecraft has been the longest-running project for acquiring moderate-resolution imagery of Earth from space. Since the 1970s, Landsat has provided regular observations of Earth's surface, monitoring renewable and nonrenewable resources and supporting programs such as global change research, coastal zone monitoring, timber management, regional planning, and environmental monitoring. Through the 1990s, data from the Landsat 5 satellite (launched in 1984) continued to prove valuable for numerous practical applications, such as forest management; wheat yield, fisheries, and water resource development; earthquake and flood damage assessments; ecological, glaciological, hydrological, and agricultural research; and geological explorations. The commercial potential of Landsat data was demonstrated by their use in efforts to fight louse infestation damage to California grape vineyards; design a complex geographic database to access fire hazard assessments, pollution runoff analyses, and power-demand predictions in the San Francisco Bay area; identify specific crop types and assess crop health and potential yield in Kansas; identify areas of rapid Chesapeake Bay-area marsh loss in which remediation efforts might be effective; and help timber companies design and implement long-range sustainable forest management plans.⁹¹

History

Landsat was a joint initiative of the Department of the Interior's U.S. Geological Survey (USGS) and NASA that was designed to gather Earth resource data from space. NASA developed and launched the spacecraft, while the USGS handled operations, maintenance, and management of

⁹¹ *Aeronautics and Space Report of the President, Fiscal Year 1995 Activities*, p. 53.

all ground data reception, processing, archiving, product generation, and distribution.⁹² The program began in the 1960s when the Department of the Interior, NASA, the Department of Agriculture, and other organizations, stimulated by success in planetary exploration using remote sensing satellites, embarked on an initiative to develop and launch the first civilian Earth-observing satellite to meet the needs of resource managers and Earth scientists. The USGS assumed responsibility for archiving the data acquired by the program and distributing the anticipated data product.⁹³ The first satellite in the Landsat series (originally named the Earth Resources Technology Satellite [ERTS]) was designed to provide repetitive global coverage of Earth's land masses and launched by NASA on July 23, 1972. The program was renamed Landsat in 1975.⁹⁴

During the 1980s, discussions about control of the Landsat system mirrored a fundamental shift in the country's policy toward remote sensing of Earth. Intense debates focused on the respective roles of the government and the private sector. One view was that the private sector should perform all civilian remote sensing (meteorological, oceanic, and land) of Earth. An opposing view was that this was a proper function of government since it was for the common good. As a compromise, it was decided that the government would handle land remote sensing, while meteorological and oceanic remote sensing would go to the private sector.

This compromise remained in place through the early part of the decade. NASA was responsible for operating the Landsat system, while the USGS had responsibility for archiving the data and

⁹² "Landsat: A Global Land-Observation Project,"

http://landsat.usgs.gov/project_facts/files/landsat_fact_sheet_20023-03.pdf (accessed February 14, 2006).

⁹³ "Landsat: A Global Land-Observing Program," Fact Sheet 023-03 (March 2003),

<http://erg.usgs.gov/isb/pubs/factsheets/fs02303.html> (accessed February 15, 2006).

⁹⁴ "Science Writers' Guide to Landsat 7," March 1999, p. 1,

http://eosps0.gsfc.nasa.gov/ftp_docs/Landsat7_writer_guide.pdf (accessed January 31, 2007).

producing image products. In January 1983, a plan was made to transfer operation of the Landsat program (consisting of land remote sensing) to the private sector. The first step of this plan transferred the Landsat system from NASA to NOAA, part of the Department of Commerce (DOC).⁹⁵ The Land Remote Sensing Commercialization Act of 1984 charged NOAA with transferring the Landsat program to the private sector. In October 1985, the Earth Observation Satellite Company (EOSAT), a partnership of Hughes and RCA (later Space Imaging), was selected by NOAA to operate the Landsat system under a 10-year contract. EOSAT would operate Landsats 4 and 5 and build two new satellites (Landsats 6 and 7) with government funds. EOSAT received exclusive rights to market Landsat data collected before the date of the contract through July 16, 1994—the contract’s expiration date—and data collected after the contract date for 10 years from the date of acquisition. It also received all foreign ground station fees. The primary effects of the commercialization of Landsat data was a substantial increase in the price and a loss of government control of the acquisition policy. Use of data declined with the price increase, and the systematic data acquisition was replaced by a policy of acquiring only requested data.⁹⁶

This policy was in force until 1992, when President Bush signed into law the Land Remote Sensing Policy Act of 1992, which repealed the 1984 act and began to shift the Landsat program

⁹⁵ “Landsat: A Global Land-Observing Program,” Fact Sheet 023-03 (March 2003), <http://erg.usgs.gov/isb/pubs/factsheets/fs02303.html> (accessed February 15, 2006).

⁹⁶ “Landsat 7 Color Brochure,” <http://landsat.gsfc.nasa.gov/main/PDF/Landsat.pdf> (accessed February 14, 2006). Also “Science Writers’ Guide to Landsat 7,” March 1999, p. 1, http://eospsa.gsfc.nasa.gov/ftp_docs/Landsat7_writer_guide.pdf (accessed February 15, 2006); E.J. Sheffner, “The Landsat Program and Landsat Science,” <http://geo.arc.nasa.gov/sge/landsat/lswg.html> (accessed March 20, 2006); U.S. Congress, Senate Report 104-081 “Landsat Amendments Act of 1995,” 104th Congress, 1st sess., May 15, 1995, http://thomas.loc.gov/cgi-bin/cpquery/?&dbname=cp104&sid=cp104k3Hfz&refer=&r_n=sr081.104&item=&sel=TOC_2330 (accessed March 20, 2006).

from the commercial sector back to the federal government, transferring oversight from NOAA and operations by EOSAT to a joint NASA-DOD Landsat Program Management. The act also:

- Directed Landsat program management to contract with the private sector for Landsat 7
- Directed Landsat program management to negotiate with EOSAT for the phased introduction of a pricing system for data from Landsats 4–6 that would enable researchers to purchase the data at “the cost of fulfilling the user request”
- Provided that the outcome of negotiations with EOSAT should be a transition to a data policy consistent with the data policy established in the legislation for Landsat 7 data
- Required a data policy for Landsat 7 data ensuring that such data would be available to all users at the cost of fulfilling user requests
- Authorized the Secretary of Commerce to license operators of private sector remote sensing systems
- Directed the President to establish a 5-year technology demonstration program to assess advanced technologies and approaches for their potential use on Landsat 8⁹⁷

The basis for this reversal was the realization that a broad national constituency, including state and local governments, had become dependent on observations from meteorological satellites, and, therefore, the federal government needed to guarantee the availability of past, present, and future Landsat data. This act identified data continuity as the fundamental goal of the Landsat

⁹⁷ “Science Writers’ Guide to Landsat 7,” March 1999, p. 1, http://eosps0.gsfc.nasa.gov/ftp_docs/Landsat7_writer_guide.pdf (accessed January 31, 2007).

program.⁹⁸ The same year, Congress authorized the procurement, launch, and operation of a new Landsat satellite, Landsat 7.⁹⁹

On October 5, 1993, NASA launched Landsat 6. This commercial program, developed by the Department of Commerce (NOAA) and the EOSAT Company, was designed to provide data for a wide range of Earth resources applications, including environmental monitoring, natural resource exploration, urban planning, and cartography. It differed from previous Landsat missions in that it carried only one remote sensing instrument—the Enhanced Thematic Mapper (ETM). The Landsat 6 spacecraft, built by GE Astro Space, was based on RCA’s Advanced Television Infrared Observation Satellite-N/Defense Meteorological Satellite Program (TIROS-N/DMSP) spacecraft design, which was used for the operational NOAA and DMSP polar-orbiting meteorological spacecraft.¹⁰⁰ The spacecraft failed to achieve orbit, however, leading NASA to develop and carry out a plan to keep Landsats 4 and 5 operational well beyond their design life. Landsats 4 and 5 carried both the multispectral scanner system (MSS) and the thematic mapper (TM) sensors. The MSS sensors were identical to those carried on Landsat 3. The TM sensors on Landsats 4 and 5 were improvements over earlier instruments and operated in seven spectral bands at a spatial resolution of 120 meters (394 feet) for the thermal-infrared band and 30 meters (98.4 feet) for the six reflective bands. The band characteristics of the MSS and TM are shown in tables 2-60 and 2-61.¹⁰¹

⁹⁸ “Landsat 7 Press Kit,” April 1999, NASA, USGS, p. 10, <http://landsat.gsfc.nasa.gov/announcements/landsat7.pdf> (accessed February 16, 2006).

⁹⁹ “Landsat 7 Basic Facts,” <http://landsat.gsfc.nasa.gov/project/L7basix.html> (accessed February 14, 2006).

¹⁰⁰ “Landsat 6,” NSSDC Master Catalog, <http://nssdc.gsfc.nasa.gov/nmc/tmp/LNDSAT6.html> (accessed March 20, 2006).

¹⁰¹ “Landsat 6,” <http://www.earth.nasa.gov/history/landsat/landsat6.html> (accessed January 5, 2006).

The failure of on-board electronics on Landsat 4 halted data collection by the satellite in August 1993. The spacecraft was maintained on orbit as a testbed until it was decommissioned in June 2001. Landsat 5 continued to orbit at an altitude of 705 kilometers (438 miles), providing a 16-day, 233-orbit cycle.

Table 2-62 presents Landsat 6 characteristics.

In May 1994, President Bill Clinton signed a Presidential Decision Directive to further stabilize the Landsat program.¹⁰² This directive clarified the roles of NASA and the Departments of Commerce, Interior, and Defense. In particular, it charged NASA with assuming responsibilities previously shared with DOD and developing a strategy to maintain the continuity of Landsat-type data beyond Landsat 7. NOAA was to manage Landsat 7 mission operations. The USGS's EROS Data Center, under the Department of the Interior (DOI), would maintain the national archive of existing and future Landsat-type remote sensing data within the United States, and would make this data readily available to the federal government and other users. DOD withdrew from the program, and NASA was named the lead agency in working with NOAA and USGS. The Space Imaging contract was transferred from NOAA to USGS in 1998, but Space Imaging continued to operate Landsats 4 and 5.¹⁰³ Also in 1994, Landsat became part of the EOS program. A memorandum of understanding (MOU) regarding Landsat 7 and EOS AM-1 (the first satellite in Phase 2 of the MTPE program) was signed in 1996. The MOU specified that the

¹⁰² "Landsat Remote Sensing Strategy," (National Science and Technology Council) NSTC-3, May 5, 1994, <http://www.au.af.mil/au/awc/awcgate/nstc3.htm> (accessed February 15, 2006).

¹⁰³ "Landsat: A Global Land-Observing Program," Fact Sheet 023-03, March 2003, <http://erg.usgs.gov/isb/pubs/factsheets/fs02303.html> (accessed February 15, 2006).

two spacecraft would be flown in “loose formation” covering the same ground track 15–60 minutes apart. Significant benefits resulted from this arrangement.¹⁰⁴

Meanwhile, in 1996, NASA began the New Millennium Program (NMP), designed to identify, develop, and flight-validate key instrument and spacecraft technologies that could enable new or more cost-effective approaches to conducting science missions in the next century. The first NMP Earth-orbiting mission, Earth Observing-1 (EO-1), would be an advanced land imaging mission demonstrating new instruments and spacecraft systems, and helping to ensure the continuity of Landsat-type data. It would validate technologies that could help reduce the cost of follow-on Landsat missions. The prime EO-1 instrument, the Advanced Land Imager, would have one-seventh the mass, power consumption, and volume of the Landsat 7 imager, the Enhanced Thematic Mapper Plus (ETM+).¹⁰⁵

Landsat 7 launched successfully on April 15, 1999 from Vandenberg Air Force Base, California. Its Sun-synchronous polar orbit allowed it to maintain a constant orientation between Earth and the Sun. As a result, the mean Sun time at each point in the orbit remained fixed. The 705-kilometer (438-mile) Earth mapping orbit had a 16-day repeat cycle. The orbits of Landsats 5 and 7 were offset, allowing eight-day repeat coverage.¹⁰⁶

Landsat 7 produced Landsat scenes based on the World Wide Reference System, a catalog of more than 57,000 land mass and coastal scenes, each 185 kilometers (115 miles) wide by 170

¹⁰⁴ George J. Komar et al., “The Landsat Program: Toward Landsat 7 and Beyond,” paper presented August 22, 1996, <http://geo.arc.nasa.gov/sge/landsat/pecora.html> (accessed February 20, 2006).

¹⁰⁵ “Landsat 7 Press Kit,” April 1999, NASA, USGS, p. 10, <http://landsat.gsfc.nasa.gov/announcements/landsat7.pdf> (accessed February 16, 2006).

¹⁰⁶ “Landsat: A Global Land-Observing Program,” Fact Sheet 023-03, March 2003.

kilometers (106 miles) long.¹⁰⁷ Its payload consisted of a single nadir-pointing instrument, the ETM+. The ETM+ provided for an eight-band multispectral scanning radiometer capable of providing high-resolution image information of Earth's surface. It had a thermal infrared channel with 60-meter (197-foot) spatial resolution, a panchromatic band with 15-meter (49.2-foot) spatial resolution, and on-board, full-aperture, 5 percent absolute radiometric calibration, as well as the six reflective bands found on the earlier TM. The ETM+ provided scientists with critical data about Earth's land surfaces, geological features, and vegetation cover.¹⁰⁸ Band characteristics are shown in table 2-63.

The Landsat 7 spacecraft was built by Lockheed Martin in Valley Forge, Pennsylvania. The ETM+ instrument was a product of Hughes Santa Barbara Remote Sensing. Construction of both was managed through contracts between the manufacturers and Goddard.¹⁰⁹ Figure 2-9 shows a drawing of Landsat 7.

¹⁰⁷ *1999 EOS Reference Handbook*, p. 73, http://eosps0.gsfc.nasa.gov/ftp_docs/handbook99.pdf (accessed February 13, 2006).

¹⁰⁸ "Landsat 7," http://science.hq.nasa.gov/missions/satellite_48.htm (accessed February 15, 2006).

¹⁰⁹ "Landsat 7 Comparison," <http://landsat.gsfc.nasa.gov/project/Comparison.html> (accessed February 20, 2006).

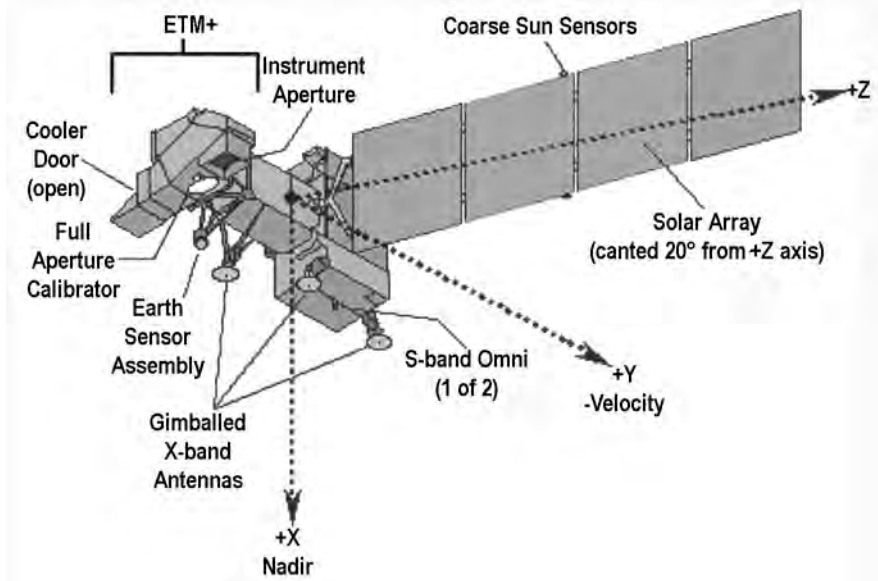

Figure 2-9. Landsat 7 satellite as viewed from the Sun side (Landsat 7 Science Data Users Handbook).

Table 2-64 provides a Landsat program chronology from 1989 to 1998. See table 2-65 for further mission information. Table 2-66 lists members of the Landsat science investigation teams.

Laser Geodynamics Satellite II (LAGEOS II)

LAGEOS II, a joint U.S.-Italian project, was designed to provide precise measurements of movements in Earth's tectonic plate. It launched October 22, 1992 on STS-52 from the Space Shuttle *Discovery*. LAGEOS II was deployed on flight day 2 of the mission and boosted into an initial elliptical orbit by the solid-fueled Italian Research Interim Stage (IRIS), which was flying for the first time (see figure 2-10). Its apogee kick motor later fired to adjust the spacecraft's orbit at an operational altitude of 5,616 kilometers by 5,905 kilometers (3,490 miles by 3,669 miles).¹¹⁰

¹¹⁰ E-mail from Carey Noll; data provided by LAGEOS science contact Peter Dunn (November 25, 2005).

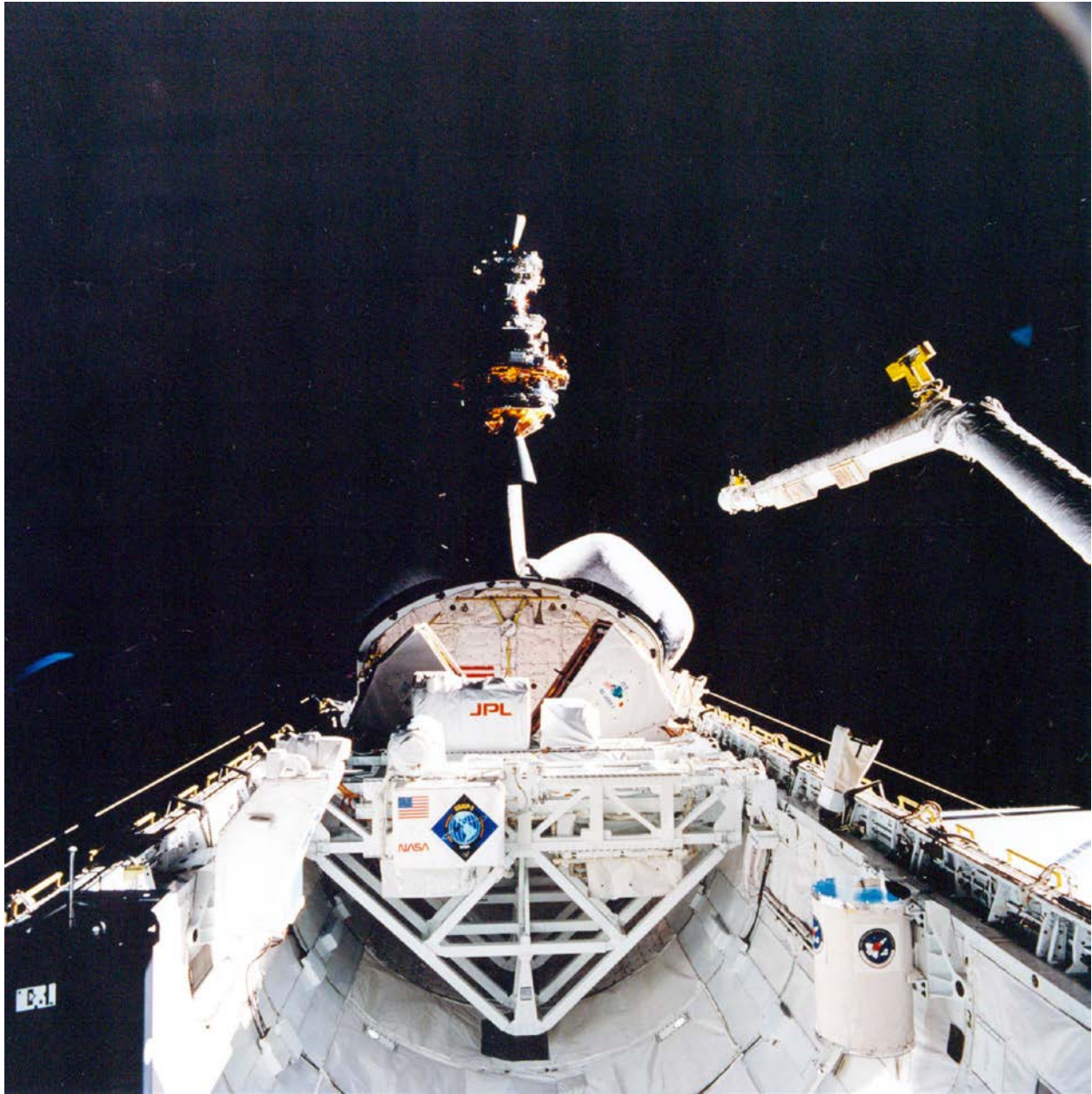

Figure 2-10. During STS-52 deployment activities, the Italian Research Interim Stage (IRIS), a spinning solid fuel rocket, lifts the Laser Geodynamics Satellite II (LAGEOS II) out of its support cradle and above the thermal shield aboard Columbia (NASA photo STS052-80-030).

LAGEOS II was a dense 0.6-meter (2-foot)-diameter spherical satellite with an aluminum shell wrapped around a brass core and 426 cube-corner retroreflectors embedded in the satellite's surface; 422 of these retroreflectors were made of fused silica glass, while the other four were

made of germanium (see figure 2-11). The design was a compromise among numerous factors. It needed to be as heavy as possible to minimize the effects of non-gravitational forces but light enough to be placed in a high orbit. It also had to accommodate as many retroreflectors as possible while still minimizing the surface area to lessen the effects of solar pressure. The materials were chosen to reduce the effects of Earth's magnetic field on the satellite's orbit.¹¹¹



Figure 2-11. LAGEOS II satellite in the apogee stage structure (Alenia Spazio brochure provided by Carey Noll, GSFC).

¹¹¹ “40+ Years of Earth Science: Laser Geodynamics Satellite-2,” <http://www.earth.nasa.gov/history/lageos/lageos2.html> (accessed January 12, 2006).

A passive satellite, LAGEOS II had no onboard sensors or electronics and was not attitude-controlled.¹¹² The retroreflectors “bounced” pulses beamed from Earth stations back to their sources. Measurements of the time it took a pulse to travel to the satellite and back to Earth allowed high accuracy in determining specific positions, and such measurements over many years would tell scientists how far specific locations on Earth moved relative to one another. Since most earthquakes and volcanic eruptions occur where plates meet, LAGEOS II shed light on how those events occurred and when they were likely to happen. A team of 27 international investigators representing the United States, Italy, Germany, France, the Netherlands, and Hungary studied the data from LAGEOS II. The spacecraft was built by Alenia Spazio for the Italian space agency based on NASA’s LAGEOS I design. Alenia Spazio was also responsible for the thermal control and the structure of the LAGEOS apogee stage that held the satellite in place during launch. The system contained the apogee kick motor and electronics for transfer orbit control.¹¹³ See table 2-67 for further mission information and table 2-68 for a list of LAGEOS investigations.

Radar Satellite (RADARSAT-1)

The first radar satellite (RADARSAT-1), a joint program of the CSA, NASA, and NOAA, was an advanced EOS project developed by Canada to monitor environmental change and support resource sustainability. It provided detailed information on ice cover for climate research and radar imagery for applications in oceanography, agriculture, forestry, hydrology, and geology. The satellite also provided real-time data for Arctic Ocean navigation, including iceberg surveillance, and made the first full map of the Antarctic ice sheet.

¹¹² “40+ Years of Earth Science: Laser Geodynamics Satellite-2,” <http://www.earth.nasa.gov/history/lageos/lageos2.html> (accessed January 12, 2006).

¹¹³ *Aeronautics and Space Report of the President, Fiscal Year 1993 Activities*, p. 52.

The RADARSAT-1 program involved both public and private Canadian sectors. The public sector included the CSA, the Canadian government, and the provincial governments of Quebec, Ontario, Saskatchewan, and British Columbia. The satellite was fully owned and operated by the Canadian government, and Canada also provided the radar instrument and managed the mission. NASA provided the Delta II launch vehicle and arranged for launch from Vandenberg Air Force Base, California. NASA and NOAA participated in the data analysis.¹¹⁴ The information supplied by RADARSAT-1 supported commercial and scientific users in such fields as disaster management, interferometry, agriculture, cartography, hydrology, forestry, oceanography, ice studies, and coastal monitoring.¹¹⁵

RADARSAT-1 was the world's first fully successful commercial synthetic aperture radar (SAR) satellite. Its active microwave sensor allowed 24-hour data collection regardless of weather conditions and illumination. The SAR sensor used a 5.6-centimeter (2.2-inch) wavelength (C-band) and had HH polarization (horizontal transmit, horizontal receive) and selective viewing angles that allowed a wide range of terrain conditions, applications, and ground coverage requirements to be accommodated.¹¹⁶

The SAR sensor could image Earth regardless of the time of day, clouds, haze, or smoke over an area. The instrument was classified as "active" because it emitted the microwave energy necessary to image Earth's surface. In contrast, "passive" or "optical" sensors relied on the Sun's

¹¹⁴ "NASA's Mission to Planet Earth: Space-Based Missions, 1994–2000, NASA Facts, February 1994, NASA History Division folder 18482, Historical Reference Collection, NASA Headquarters, Washington, DC. Also "CSA—RADARSAT-1: Milestones," <http://radarsat.space.gc.ca/asc/eng/satellites/radarsat1/milestones.asp> (accessed February 13, 2006).

¹¹⁵ "RADARSAT-1 Celebrates Ten Years in Space," *Directions Magazine*, November 4, 2005, <http://www.directionsmag.com/press.releases/index.php?duty=Show&id=12953> (accessed May 23, 2007).

¹¹⁶ "RADARSAT," <http://www.crisp.nus.edu.sg/rsat/rsat.html> (accessed February 15, 2006).

reflected energy to image Earth. The SAR sensor on RADARSAT-1 had the unique capability to acquire data in any of 25 possible imaging modes. Each mode varied with respect to swath width, resolution, incidence angle, and number of looks. Imaging modes for RADARSAT-1 included Fine, Standard, Wide, ScanSAR (narrow and wide), and Extended Beam (high and low incidence angles).¹¹⁷ Because different applications required different imaging modes, RADARSAT-1 gave users tremendous flexibility in choosing the most suitable types of SAR data for their applications.¹¹⁸ Table 2-69 lists generalized RADARSAT-1 SAR applications.

In 1994, the Canadian government established its Long-Term Space Plan. RADARSAT-1 was a main element of the plan.

RADARSAT-1 was launched on November 4, 1995. Designed for a 5-year lifetime, it continued to operate into the next decade. The satellite traveled in a Sun-synchronous polar orbit. This orbit placed the satellite's solar arrays in almost continuous sunlight, which ensured the satellite's successful use of solar rather than battery power and provided users with the optimum number of viewing opportunities.¹¹⁹

RADARSAT-1 sent its first image on November 28, 1995, showing a portion of Cape Breton Island in Nova Scotia, Canada. Covering an area of 132 kilometers by 127 kilometers (82 miles

¹¹⁷ "RADARSAT," <http://www.crisp.nus.edu.sg/rsat/rsat.html> (accessed February 15, 2006).

¹¹⁸ "RADARSAT," Australian Government, Geoscience Australia, http://www.ga.gov.au/acres/prod_ser/radadata.jsp (accessed May 23, 2007).

¹¹⁹ RADARSAT: Components and Specifications, <http://radarsat.space.gc.ca/asc/eng/satellites/radarsat1/components.asp> (accessed March 1, 2006).

by 80 miles), it revealed geological and land-use patterns, as well as wind and current patterns in lakes and the surrounding oceans.¹²⁰

In 1997, RADARSAT-1 was rotated in orbit so that its SAR antenna looked south toward Antarctica. This permitted the first high-resolution mapping of the entire continent of Antarctica. In less than three weeks, the satellite acquired a complete coverage of radar image swaths as part of the first Antarctic Mapping Mission (AMM-1). Swath images were assembled into an image mosaic depicting the entire continent at 25-meter (82-foot) resolution. The mosaic provided a detailed look at ice sheet morphology, rock outcrops, research infrastructure, the coastline, and other features of Antarctica. In addition, it provided calibrated radar backscatter data that could potentially provide insight into climate processes affecting the upper few meters of snow cover. The RADARSAT-1 Antarctic Mapping Project was a joint effort of NASA and CSA.¹²¹ Figure 2-12 shows a drawing of the satellite. See table 2-70 for further information.

¹²⁰ "Milestones," <http://radarsat.space.gc.ca/asc/eng/satellites/radarsat1/milestones.asp> (accessed March 1, 2006).

¹²¹ "RADARSAT Antarctic Mapping Project," National Snow and Ice Data Center Distributed Active Archive Center, <http://nsidc.org/daac/ramp/> (accessed February 15, 2006).

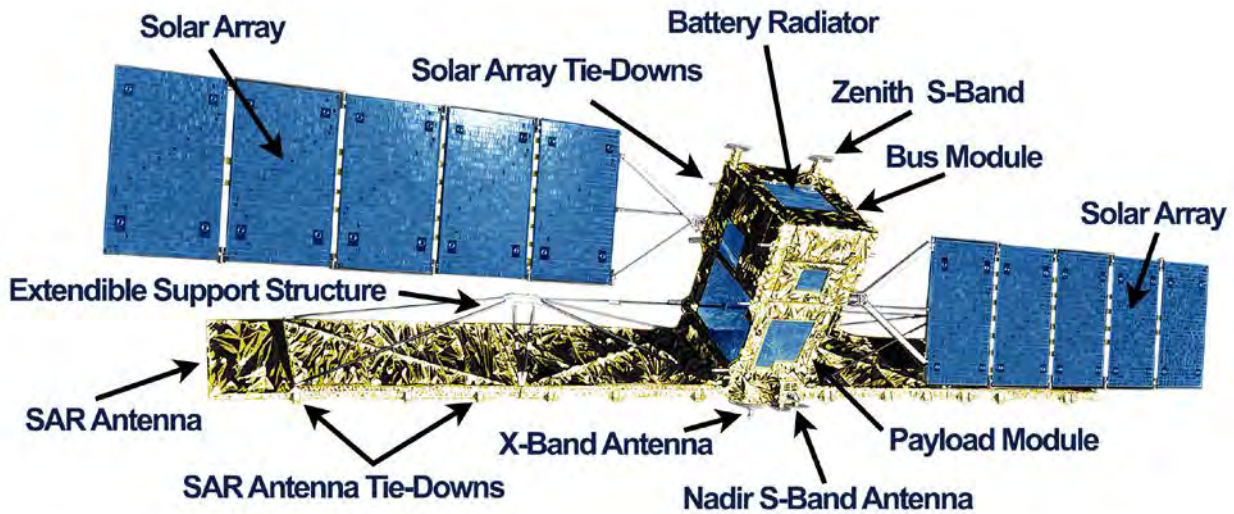

Figure 2-12. RADARSAT-1 (Canadian Space Agency, <http://www.space.gc.ca>)

Atmospheric Studies

NASA's atmospheric studies concentrated on monitoring ozone depletion, primarily with UARS, the two Airborne Arctic Stratospheric Expedition (AASE) satellites, and TOMS. NOAA meteorological satellites also monitored ozone along with their other functions. One area of special interest was the effects of the Mount Pinatubo eruption in June 1991. Data from NASA instruments, such as TOMS aboard the Russian Meteor-3 satellite (launched in 1991), as well as NOAA instruments aboard balloons and the polar-orbiting NOAA-9 satellite, enabled scientists to study the global cooling effects and loss of ozone resulting from the eruption. These were the first unambiguous, direct measurements of large-scale changes in Earth's radiation budget caused by a volcanic eruption.¹²² In addition, the Earth Radiation Budget Satellite (ERBS), which had been launched from STS-41-G in 1984, continued to monitor stratospheric aerosols and provide critical ozone data.

¹²² *Aeronautics and Space Report of the President, Fiscal Year 1993 Activities*, p. 55.

Earth Radiation Budget Satellite

ERBS was designed as a two-year mission to gather radiation budget data, aerosol data, and ozone data to assess climate change and ozone depletion. The satellite was designed and built by Ball Aerospace Systems under contract to Goddard. It was the first spacecraft dedicated to NASA science experiments to be launched by the Space Shuttle.¹²³

The satellite had three scientific instruments: SAGE II built by Ball Aerospace, the Earth Radiation Budget Experiment (ERBE) nonscanner built by TRW, and the ERBS scanner also built by TRW. The spacecraft structure consisted of three basic modules: the keel module, the base module, and the instrument module. The keel module was a torque-box structure that provided structural support for the propulsion system, the solar array panels, and the antennas. The base module was a torque-box structure that provided a direct interface to the Shuttle. The ERBE nonscanning instrument and electronics were attached to the base module. The instrument module was mounted directly to the base module and housed the ERBS scanner and the SAGE II instrument. Each instrument had contamination doors that protected the sensitive detectors and optics from accumulating outgassing products from the spacecraft.

The ERBS scanner failed on February 28, 1990; however, the nonscanning instrument and SAGE II functioned as late as 2005.¹²⁴ Figure 2-13 shows the SAGE II Shuttle launch package. See table 2-71 for further mission information.

¹²³ "Earth Radiation Budget Experiment (ERBE) Solar Monitor Irradiance Langley ASDC Data Set Document," Atmospheric Science Data Center, http://eosweb.larc.nasa.gov/GUIDE/dataset_documents/erbe_tsi_erbs_dataset.html (accessed March 14, 2006).

¹²⁴ "SAGE II Mission Status," http://www-sage2.larc.nasa.gov/mission_status/ (accessed March 20, 2006).



Figure 2-13. The ERBE SAGE II Shuttle Launch Package was designed to measure and analyze fluctuations in the amount of heat energy emitted by the Sun and reflected or absorbed by Earth (NASA photo EL-2001-00409, NASA LaRC).

Microlab-1

Microlab-1 (renamed OrbView-1 in 1997) was launched from an airborne Pegasus launch vehicle on 3 April 1995.¹²⁵ It carried two sensors: the Optical Transient Detector (OTD), provided by Marshall Space Flight Center and the GPS Meteorology (GPS Met) atmospheric monitoring instrument, sponsored by the NSF and the University Consortium for Atmospheric

¹²⁵ Two communications payloads—ORBCOMM-FM1 and ORBCOMM-FM2—were also deployed on this mission.

Research and developed by JPL. The Microlab atmospheric imaging satellite provided the world's first broad-area cloud-to-cloud lightning data.

The Microlab/OrbView program resulted from a government–industry partnership between ORBIMAGE (a company partly owned by Orbital Sciences Corporation) and NASA. Under this arrangement, NASA provided the OTD sensor for use on OrbView-1, and ORBIMAGE agreed to conduct an initial six-month experiment USING the sensor.¹²⁶

The GPS Met, a modified commercial high-precision GPS receiver, proved that signals from the U.S. military GPS satellite constellation used for precision navigation could also be used to provide atmospheric data to researchers. By precisely measuring the GPS's increasing travel time and fluctuating signal strength as the atmosphere caused the signal's path to bend, observers could recover highly accurate profiles of atmospheric density, pressure, temperature, and, to some degree, turbulence and winds. GPS Met was also used to study the amount of water vapor in the lower atmosphere.¹²⁷

The OTD was a highly compact combination of optical and electronic elements that increased our understanding of Earth's atmosphere system by investigating the distribution and variability of total lightning over Earth. The instrument detected momentary changes in an optical scene that indicated the occurrence of lightning and detected, located, and measured the intensity of

¹²⁶ “ORBIMAGE's Orbview-1 Imaging Satellite Celebrates Fifth Anniversary in Orbit,” Press Release, April 7, 2000, Orbital Sciences Corporation, <http://www.orbimage.com/news/releases/04-07-00.html> (accessed May 23, 2007).

¹²⁷ “JPL Instrument Will Measure Earth's Atmospheric Temperature, Jet Propulsion Laboratory,” *Universe* 25, no. 7 (April 7, 1995): 1, http://www.jpl.nasa.gov/releases/95/release_1995_9524.html (accessed January 12, 2006). Also “ORBIMAGE's Orbview-1 Imaging Satellite Celebrates Fifth Anniversary in Orbit,” Press Release, April 7, 2000, Orbital Sciences Corporation, <http://www.spaceref.com:16080/news/viewpr.html?pid=1371> (accessed February 28, 2006).

lightning during both daytime and nighttime with a detection efficiency ranging from 40 percent to 65 percent. Because the OTD never observed a given location for more than a few minutes each day, its data were more suitable for studying global lightning patterns and how they changed with time than for studying localized weather.¹²⁸ Figure 2-14 shows the satellite. See table 2-72 for further mission information.

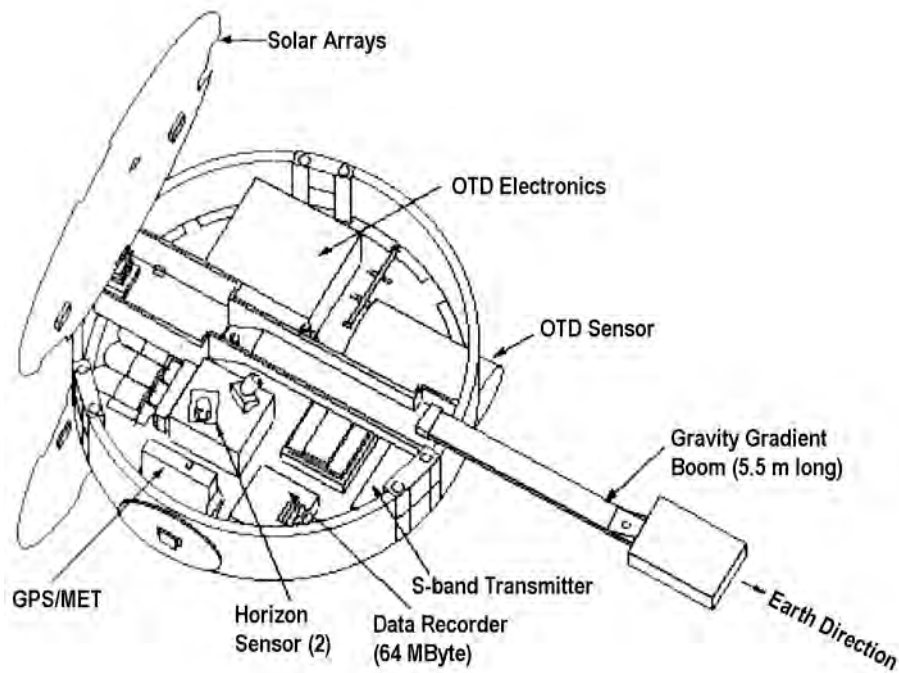

Figure 2-14. OrbView-1 spacecraft (“Orbiew-1,” Earth Observation Portal http://directory/eoportal.org/pres_OrbView1.html).

Upper Atmosphere Research Satellite S

The UARS program was the first major flight element of NASA’s MTPE. Its primary aim was to gather extensive data on the planet’s threatened ozone layer and provide details on chemical

¹²⁸ “Optical Transient Detector,” Space Research & Observations, <http://thunder.nsstc.nasa.gov/otd/> (accessed February 28, 2006). Also “Background: Optical Transient Detector,” http://www.ghcc.msfc.nasa.gov/otd_old.html (accessed January 12, 2006).

processes taking place in the upper atmosphere, and the effect of humans on these processes. It performed the first systematic detailed satellite study of Earth's stratosphere, mesosphere, and lower thermosphere, established the comprehensive database needed to understand stratospheric ozone depletion and to assess the role of human activities in atmospheric change, and laid the foundation for a broader study of the influence of the upper atmosphere on climate and climate variations. Carrying 10 instruments and weighing more than 7 tons, the spacecraft was the largest, most complex, and most expensive environmental satellite ever built.

In 1976, Congress responded to the identification of new causes of ozone depletion by directing NASA in the 1976 NASA Authorization Act to “develop and carry out a comprehensive program of research, technology and monitoring of the phenomena of the upper atmosphere so as to provide for an understanding of and to maintain the chemical and physical integrity of Earth's upper atmosphere.”¹²⁹ The Clean Air Act Amendments of 1977 (Public Law 95-95) further directed NASA to “continue programs of research, technology, and monitoring of the stratosphere for the purpose of understanding the physics and chemistry of the stratosphere and for the early detection of potentially harmful changes in the ozone of the stratosphere.”¹³⁰ A research initiative was established involving sounding rockets, aircraft, and balloons along with laboratory and theoretical studies. These investigations confirmed that manufactured chemicals were indeed depleting stratospheric ozone, and NASA identified requirements for a satellite to study the changing properties of Earth's atmosphere on a global scale to spearhead a long-term, international space research program. Only remote sensing from space, it concluded, could

¹²⁹ *A Bill To Authorize Appropriations to the National Aeronautics and Space Administration for Research and Development, Construction of Facilities, and Research and Program Management*, June 19, 1975, H.R. 4700, Public Law 94-39, 94th Congress, 1st sess. Quoted in “Upper Atmosphere Research Satellite (UARS) Prelaunch Mission Operations Report,” Report No. S-678-48-91-01, April 30, 1991, p. 2, and in “All Information” reference to H.R. 4700 on <http://thomas.loc.gov> (accessed January 17, 2007).

¹³⁰ *Clean Air Act Amendments of 1977*, Public Law 95-95, August 7, 1977, 95th Congress, 1st sess.

provide the temporal and spatial coverage needed to study such highly variable processes worldwide.

NASA officially announced its intent to develop UARS in 1979.¹³¹ In early 1980, a preliminary selection of candidate instruments was made from proposals solicited from national and international atmospheric physics communities. Following a definition study of candidate instruments, a final selection of nine instruments was made in November 1981 based on scientific merit for the mission and maturity of design. After selection, two additional instruments, the Solar Backscatter Ultraviolet (SBUV) measurement system and the Active Cavity Irradiance Monitor (ACRIM), developed for other flight programs, were added to the mission as mission-of-opportunity instruments to extend databases already begun as part of earlier flight programs.¹³² In 1984 the SBUV was removed from the payload complement because an identical instrument was designated to be flown in the same time frame on an operational NOAA satellite.¹³³ The observatory instrument module structure completed its qualification testing in 1989, and all 10 of the instruments were delivered by January 1990. Full integration and testing of the spacecraft and instruments was completed in the summer of 1990.¹³⁴

¹³¹ “UARS Science Highlights: A Summary of the Upper Atmosphere Research Satellite (UARS),” http://uars.gsfc.nasa.gov/www_root/homepage/uars-science/science_highlights1.html#facts (accessed January 12, 2006).

¹³² “Execution Phase Project Plan for the Upper Atmosphere Research Satellite,” Goddard Space Flight Center, July 1984, p. 4-1.

¹³³ Carl A. Reber, “Upper Atmosphere Research Satellite (UARS) Mission,” 430-1003-001, Goddard Space Flight Center, May 1985, p. 5, http://ntrs.nasa.gov/archive/nasa/casi.ntrs.nasa.gov/19900066464_1990066464.pdf (accessed January 31, 2007).

¹³⁴ *Aeronautics and Space Report of the President, 1989–1990 Activities* (Washington, DC: National Aeronautics and Space Administration, 1991), p. 21.

The \$750-million UARS was carried aloft by the Space Shuttle *Discovery* on 12 September 1991 and released on 15 September, the third day of the mission. NASA timed the UARS launch to coincide with the breakup of the ozone hole in 1991 and enable it to observe a full cycle during the following year. The satellite provided three-dimensional pictures of the ozone hole and the chemicals forming it.¹³⁵ Figure 2-15 shows UARS at the end of *Discovery*'s robot arm during STS-48 pre-deployment checkout procedures.

¹³⁵ W. Henry Lambright, *NASA and the Environment: The Case of Ozone Depletion*, Monographs in Aerospace History No. 38 (Washington, DC: National Aeronautics and Space Administration Special Publication-2005, 4538, 2000), p. 29.

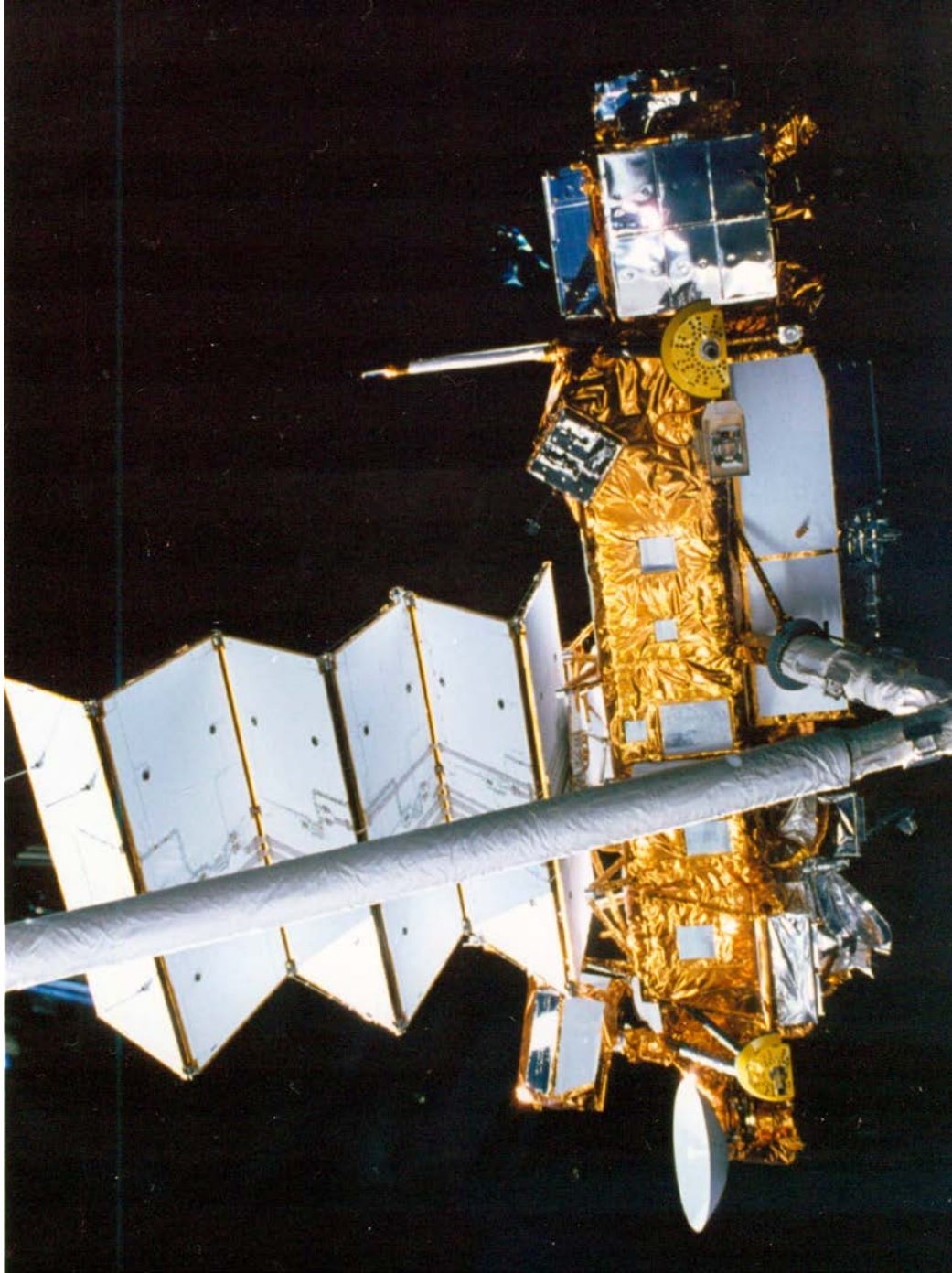

Figure 2-15. The UARS is grasped by the remote manipulator system end effector above the payload bay of Discovery. The UARS solar array is in the process of being deployed. Visible on the UARS are (top to bottom) the high-gain antenna, Solar Stellar Pointing Platform, outrigger truss, Microwave Limb Sounder, spectrometer, solar array, remote manipulator system grapple fixture, Particle Environment Monitor, Zenith Particle Environment Monitor, Nadir Particle Environment Monitor, magnetometer, outrigger truss and keel pin, and multimission modular spacecraft (NASA photo STS048-05-024).

UARS carried 10 instruments: nine complementary instruments that enabled UARS to fulfill its program objectives, and a tenth instrument that continued to measure the solar constant (see figure 2-16).¹³⁶ The common goal of these instruments was to the detailed study of energy inputs and vertical profiles of temperature, chemical species concentrations, and winds in the upper atmosphere. UARS instruments observed phenomena in the microwave, infrared, visible, and ultraviolet regions of the electromagnetic spectrum. In addition, the Particle Environment Monitor measured soft and hard x-rays, electrons, and protons, as well as magnetic fields. The infrared and microwave instruments measured atmospheric temperature and pressure and detected trace amounts of ozone, chlorofluorocarbons (CFCs), nitrogen oxides, nitric acid, water, carbon dioxide, chlorine-containing radicals, methane, and other chemical species involved in stratospheric ozone depletion. Wind velocity was measured by observing Doppler shifts using Fabry-Perot and Michelson interferometry. With a total observatory mass of 6,540 kilograms (7.2 tons), including approximately 2,390 kilograms (2.6 tons) of scientific payload, UARS occupied most of the volume of the Shuttle payload bay before deployment. In addition to the instrument payload, the observatory consisted of a specially designed instrument module and the multimission modular spacecraft (MMS). The MMS incorporated standard modules for attitude control, communications and data handling, electrical power, and propulsion. Mission-unique components included a silicon-cell solar array capable of supporting a 1,600-watt load, and a high-gain parabolic antenna compatible with the Tracking and Data Relay Satellite System.¹³⁷

¹³⁶ “Upper Atmosphere Research Satellite (UARS) Prelaunch Mission Operations Report,” Report No. S-678-48-91-01, April 30, 1991, 9.

¹³⁷ “Upper Atmosphere Research Satellite (UARS) Post Launch Mission Operation Report,” Report No. U-678-48-91-02, September 1994, 5.

UARS was far larger and more complex and comprehensive than any of its predecessors, and had considerably greater resolving power.¹³⁸

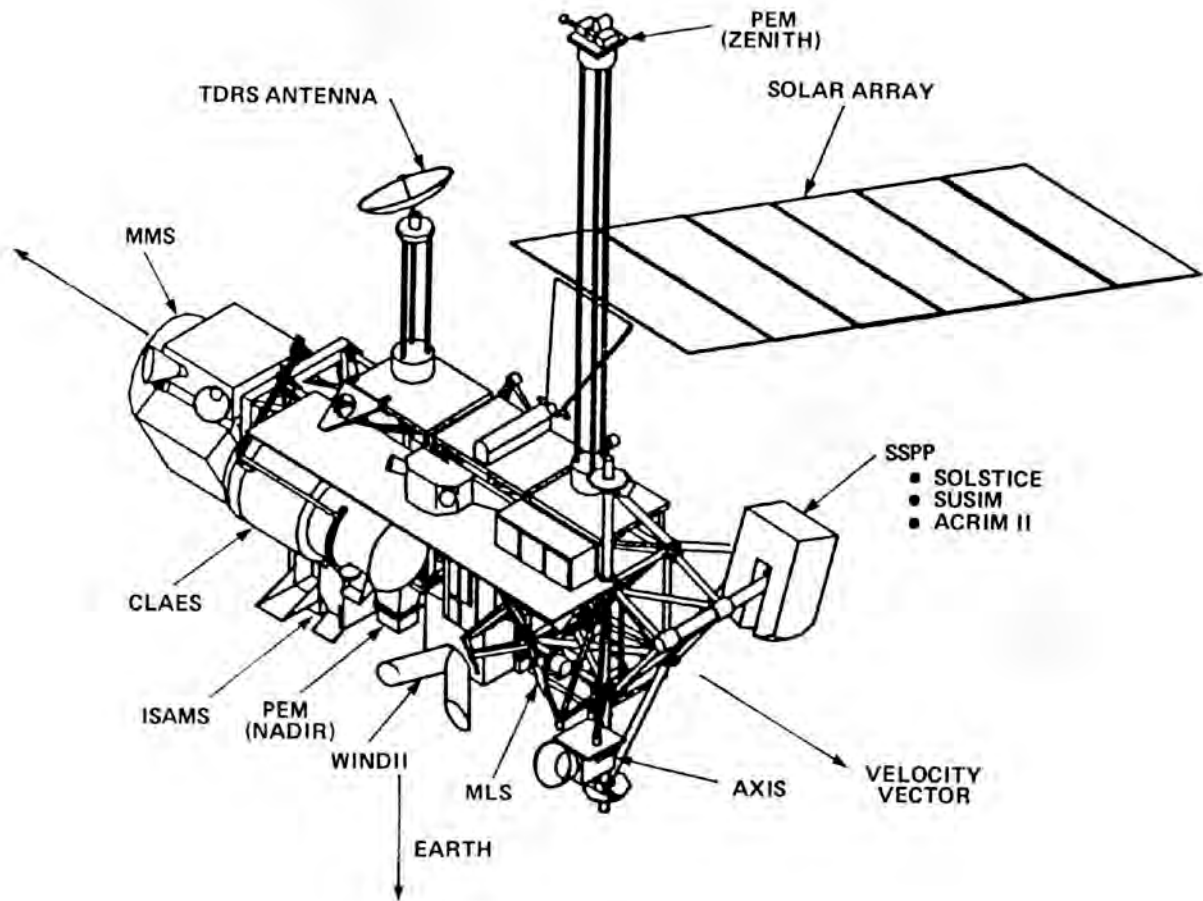

Figure 2-16. View of the UARS from the anti-Sun side, showing instrument placement, the solar array, and the multimission modular spacecraft. The HALOE and HRDI instruments cannot be seen from this view (Upper Atmosphere Research Satellite [UARS] Mission, Document 430-1003-001).

¹³⁸ “Upper Atmosphere Research Satellite (UARS) Prelaunch Mission Operations Report,” 16, 33.

UARS has led to major scientific discoveries, several are listed below:¹³⁹

- Seasonal mapping of chlorine radicals and reservoirs in the lower stratosphere. A few months after launch, the Microwave Limb Sounder (MLS) mapped ClO (chlorine monoxide—an ozone-destroying radical) within the Arctic vortex, showing the extent of ClO formation and its close association with polar stratospheric cloud formation temperatures. This was important confirmation of earlier aircraft results and also showed the extent of the zone of elevated ClO. After these initial observations, UARS continued to monitor both the Arctic and Antarctic late winter-spring ozone depletions. The Northern Hemisphere depletion in January–March 1996 was one of the largest to date.
- Containment of polar vortex chemistry within the vortex region. At the time of the UARS launch, some scientists speculated that ozone-destroying chemicals within the polar vortex would leak to mid-latitudes. Other scientists argued from a dynamical perspective that containment of the chemicals must occur. It was not until the UARS launch and trace species were mapped by UARS instruments that containment could be demonstrated.
- Infrared mapping of aerosols and polar stratospheric clouds (PSCs). Mt. Pinatubo erupted on June 15, 1991, injecting up to 20 megatons of sulfur dioxide (SO₂) directly into the stratosphere. The reaction of SO₂ with stratospheric hydroxide (OH) produced sulfuric acid that condensed into aerosols at stratospheric temperatures and pressures. UARS observations by the Cryogenic Limb Array Etalon Spectrometer (CLAES), Halogen Occultation Experiment (HALOE), and Improved Stratospheric and Mesospheric Sounder (ISAMS) were used to track the aerosol cloud from its infrared emissions. This was the first near-synoptic mapping of volcanic aerosol layers.

¹³⁹ “UARS Science Highlights; A Summary of the Upper Atmosphere Research Satellite (UARS),” http://uars.gsfc.nasa.gov/www_root/homepage/uars-science/science_highlights1.html#facts (accessed January 12, 2006).

- Descent in the center of the polar vortex. HALOE scientists were the first to notice very low concentrations of the long-lived trace gas methane (CH_4) in the center of the spring Antarctic polar vortex. Analysis showed that very low values of methane existed within the mid and upper stratosphere in late fall, and these values descended to the lower stratosphere by late spring—a net change of 12–15 kilometers (7.5–9.3 miles) over six months. This amount of descent is remarkable in any part of the atmosphere and was later confirmed by measurements by CLAES (N_2O , and CH_4) and ISAMS (N_2O and CO).
- The first direct measurement of winds from space. Both the Wind Imaging Interferometer (WINDII) and High Resolution Doppler Imager (HRDI) on UARS measured winds from space. Although the techniques differed, both relied on the Doppler shift of an oxygen emission line in the mesosphere. HRDI additionally detected daytime stratospheric winds using the Doppler shift of an oxygen absorption line in the stratosphere. These were the first remote spaceborne wind sounders. HRDI and WINDII both provided the first complete global picture of the atmospheric tide. HRDI also measured the tropical quasibiennial oscillation winds in the stratosphere.
- The first global maps of CFCs and their products from space. Some people outside the scientific community believe that CFCs are not responsible for ozone loss at the poles. They state that CFCs were heavy molecules and would never rise into the stratosphere. They credit the observed high levels of stratospheric chlorine were to volcanic activity. CLAES detected both CFC13 (F11) (fluorotrichloromethane) and CF_2Cl_2 (F12) (difluorodichloromethane) in the stratosphere. Both were found to decrease strongly with altitude above the tropopause. As the CFCs broke down in the stratosphere, they released chlorine (Cl) and fluorine (F) that formed hydrogen chloride (HCl) and hydrogen fluoride (HF). (HF was a long-lived trace gas with no

important natural sources.) HALOE detected HF and HCl in the stratosphere and found that both increased with altitude as the CFCs decreased and were increasing with time.

- Tropical transport in the stratosphere. The long lifetime of the UARS mission has led to trace gas trend information showing the vertical transport of water vapor upward in the tropical stratosphere. The amount of water vapor entering the stratosphere changes throughout the year as the tropical tropopause becomes colder and warmer. These variations in water vapor climbed slowly into the stratosphere and appear coherent to about 30 kilometers (18.6 miles) from the previous 16 kilometers (10 miles). The water vapor observations indicates that the tropical region is quite isolated from the rest of the stratosphere, since otherwise these variations would be diluted.
- Measurement of the ultraviolet and visible component of solar variability. The Active Cavity Radiometer Irradiance Monitor (ACRIM) recorded total solar irradiance, while the Solar-stellar Irradiance Comparison Experiment (SOLSTICE) and Solar Ultraviolet Spectral Irradiance Monitor (SUSIM) measured ultraviolet flux from ~121.6-400 nanometers. SOLSTICE used the stars, and SUSIM used on-board calibration lamps to correct for instrument changes over time. UARS was launched near the end of the maximum of solar cycle 22. A comparison of energy changes over the period between the maximum of solar cycle 22 and the minimum between solar cycles 22 and 23 by these instruments showed that the ultraviolet variation accounted for a significant 40 percent of the change in the total solar irradiance.
- The role of energetic particles in stratospheric chemistry. Energetic particle observations by the Particle Environment Monitor (PEM) showed that most of the relativistic electrons observed at geosynchronous altitudes (e.g., by GOES) were trapped. Only about 1–10 percent of the relativistic electron precipitations (REPs) measured at geosynchronous altitudes actually

precipitated into Earth's atmosphere. These measurements thus showed that REPs had a relatively small global effect on stratospheric odd nitrogen, which was a subject of controversy before the UARS launch.

- Upper tropospheric water vapor in the presence of clouds. The MLS team noticed that they were getting some spectral interference from water vapor. Further analysis showed that they could use the MLS to actually measure upper tropospheric water. Since the MLS was a microwave emission instrument, the measurements could be made even if ice clouds were present. These new water vapor measurements were used to study how cirrus clouds affected climate.

See table 2-73 for further mission information.

Active Cavity Radiometer Irradiance Monitor

ACRIM III was the third in a series of long-term solar-monitoring tools built for NASA by the JPL. The sensor extended the total solar irradiance (TSI) database first created by ACRIM I, which was launched in 1980 on the Solar Maximum Mission (SMM) spacecraft, and followed by ACRIM II on UARS, launched in 1991 (see above). The Earth Radiation Budget instrument (launched on Nimbus-7 in 1978), the Earth Radiation Budget Satellite (launched in 1984 and carrying the ERBE), and the Solar and Heliospheric Observatory (SOHO) satellite (launched in 1995 and carrying the Variability of Solar Irradiance and Gravity Oscillations [VIRGO] instrument) also contributed to a long-term TSI database.¹⁴⁰ Space Shuttle flights STS-45, -56,

¹⁴⁰ "ACRIM: Total Solar Irradiance (TSI) Monitoring, <http://www.acrim.com>. Also "Instrument Heritage," http://acrim.jpl.nasa.gov/missions/instrument_heritage.html (both accessed January 23, 2007).

and -66 also carried an ACR. ACRIM III was launched from the ACRIM satellite (AcrimSat) spacecraft.

The ACRIM experiment was accepted by NASA in the late 1980s as part of the EOS mission. Initially scheduled for launch as part of the EOS-CHEM platform payload, EOS restructuring removed it from the CHEM satellite in the mid-1990s and placed ACRIM III on “flight-of-opportunity” status. The implementation approach shifted to a “faster, better, cheaper” mode of a small, dedicated satellite and launch as a secondary payload. The instrument was redesigned, updated, and miniaturized to conform to the latest techniques and technology and to maximize its adaptability to a small-satellite environment. It embodied an optimized combination of the best features of the earlier ACRIM instruments along with new electronics and package design.¹⁴¹

The ACRIM III instrument included three identical active cavity radiometers used in different cycles. One monitored the Sun continuously. Data from the second instrument were compared with data from the first instrument every few months. The third sensor’s data were compared with the other two instruments’ data every two months. This rotating system of data comparison allowed anticipated slow changes in the first sensor caused by exposure to the Sun and space to be calibrated and removed from its measurement results.¹⁴² Figure 2-17 shows an illustration of the spacecraft.

¹⁴¹ Willson, “The ACRIMSAT/ACRIM III Experiment, 14.

¹⁴² “AcrimSat Launch Press Kit,” December 1999, p. 17, http://www.jpl.nasa.gov/news/press_kits/acrimsat.pdf (accessed January 23, 2007).

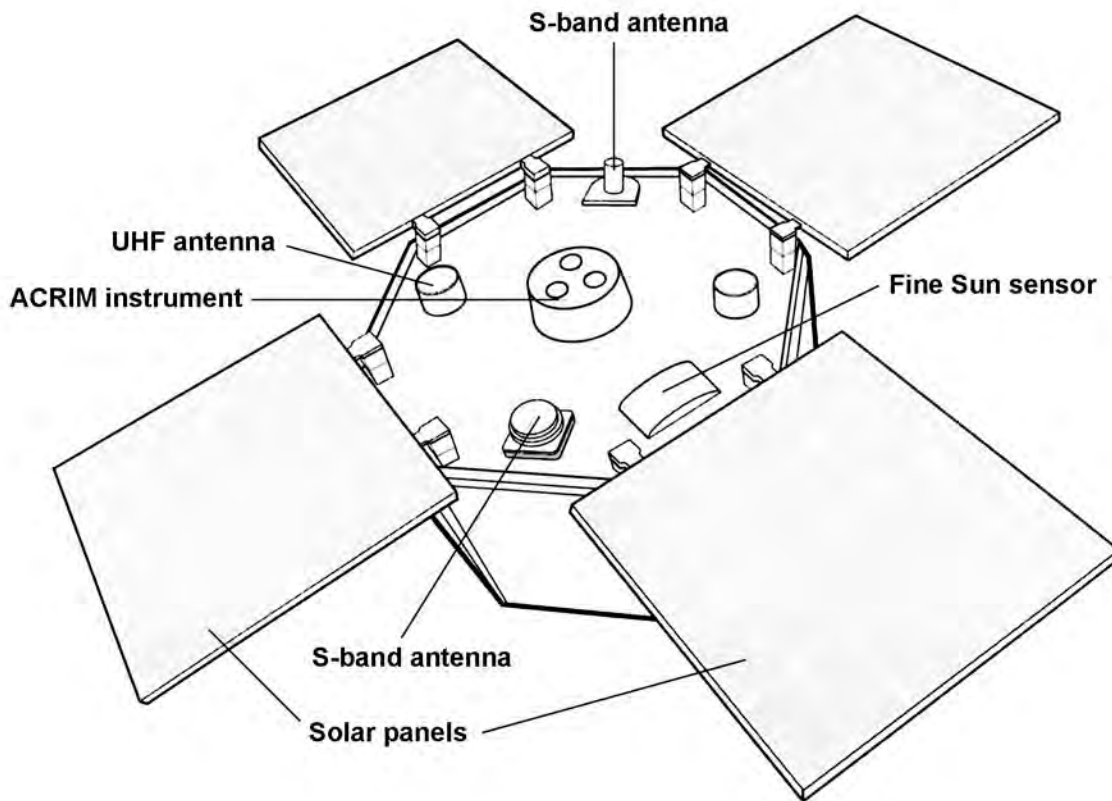

Figure 2-17. AcrimSat spacecraft (AcrimSat Launch Press Kit).

Immediately after launch, the satellite experienced an unexpected four-month period during which the instrument could not gather scientific data because it was not pointing directly at the Sun; instead, it was pointing 16 degrees away from the Sun in a higher-than-expected orbit of 443 miles (714 kilometers).¹⁴³ A series of software commands corrected the problem and allowed ACRIM III to successfully complete its mission of monitoring TSI over a five-year period.

The instrument was more than twice as light and compact as its predecessor, allowing the radiometer to be flown in a small, dedicated spacecraft such as AcrimSat. The octagonal-shaped

¹⁴³ Paul Hoversten, "Software Fix Puts Acrimsat Satellite Back on Track," Space.com, http://www.space.com/missionlaunches/missions/acrimsat_000614.html (accessed January 23, 2007).

AcrimSat was carried as a secondary payload on the Taurus launch vehicle and launched into Sun-synchronous orbit.¹⁴⁴

The AcrimSat project was funded as part of the EOS program and managed by the Earth Sciences Program Office at Goddard. The principal investigator was Dr. Richard Willson of Columbia University. The AcrimSat Project Office at JPL managed the design, fabrication, and testing of the instrument and the subcontract with Orbital Sciences Corporation, builder of the spacecraft and the Taurus launch vehicle. See table 2-74 for further information.

Airborne Arctic Stratospheric Expedition (AASE)

NASA and NOAA jointly coordinated two AASEs in 1989 and 1991–1992 to continue to study production and loss mechanisms for ozone in the polar stratosphere and to assess the growing human influence on the environment. The missions were elements of the Upper Atmospheric Research Program sponsored by NASA's Office of Space Science and Applications. The missions used the NASA ER-2, and DC-8 research aircraft, satellites, and balloons, which carried a number of detectors, samplers, spectrometers, and other instruments to analyze the stratospheric environment.

First AASE

The first AASE, staged from Stavanger, Norway, from January 1 to February 28, 1989, began about 18 months after the 1987 Airborne Antarctic Ozone Experiment, which determined that the ozone hole that appears every year over Antarctica is caused by perturbed chlorine chemistry. The primary objectives of the expedition were to study the production and loss mechanisms of

¹⁴⁴ The primary payload was a South Korean satellite.

ozone in the north polar stratospheric environment and the effect on ozone distribution of the Arctic polar vortex and the cold temperatures associated with the formation of PSCs.¹⁴⁵ Stratospheric conditions in the Southern Hemisphere winter differ in some important aspects from those of the Northern Hemisphere: the southern temperatures are colder (and the cold temperatures last longer), and the ring of winds circling the pole—the polar vortex—is more circular and isolates the polar air more. These differences affect the relevant chemical reactions that take place. AASE took measurements in the northern polar winter to determine whether the same kinds of processes observed in the Southern Hemisphere were occurring.¹⁴⁶

The AASE studied stratospheric chemistry and meteorology over the Arctic using NASA ER-2 and DC-8 aircraft. The aircraft, which flew 28 missions over the Arctic as far as the North Pole, carried instruments similar to those used in the 1987 Antarctic expedition.

The expedition investigated the chemical and dynamical processes controlling ozone in the Arctic polar stratosphere. The flights into the Arctic stratosphere took place during early winter, when polar stratospheric clouds are most likely to form. They revealed that large amounts of chlorine monoxide were found in the polar regions, and that chlorine monoxide and bromine monoxide were present at concentrations comparable to those observed over Antarctica in 1987.¹⁴⁷ Preliminary results from the study indicated that while no large ozone losses were observed in the Arctic, and scientists could not predict with certainty that a substantial loss of ozone would occur, strong perturbations in active chlorine were observed.¹⁴⁸ The highly

¹⁴⁵ “AASE Mission Overview,” <http://cloud1.arc.nasa.gov/aase/project/overview.html> (accessed February 16, 2006).

¹⁴⁶ “The Airborne Arctic Stratospheric Expedition (AASE),” GSFC Code 916: Atmospheric Chemistry and Dynamics Branch, <http://code916.gsfc.nasa.gov/Public/Analysis/aircraft/aase/aase.html> (accessed February 16, 2006).

¹⁴⁷ “The Airborne Arctic Stratospheric Expedition (AASE).”

¹⁴⁸ *Aeronautics and Space Report of the President, 1989–1990 Activities*, p. 22. Also Lambright, p. 26.

perturbed chemical composition of the Arctic polar stratosphere resembled the situation in the Southern Hemisphere winter, and these perturbations occurred over a wide range of altitudes in the stratosphere.¹⁴⁹

In addition to NASA and NOAA, other participants in the AASE included the National Science Foundation and the Chemical Manufacturers Association.¹⁵⁰

AASE II

AASE II consisted of several two-week data-gathering phases over eight months between October 1991 and April 1992. The expedition was staged from Moffett Field, California; Fairbanks, Alaska; Anchorage, Alaska; Stavanger, Norway; and Bangor, Maine.¹⁵¹ The mission used a high altitude ER-2 aircraft for in-situ studies of the lower stratosphere and a long-range DC-9 for remote sensing observations. AASE II involved 100 scientists from NASA, NOAA, the NSF's National Center for Atmospheric Research, many universities, and an industry group.¹⁵² The extended aircraft campaign investigated the Arctic polar stratosphere over the complete annual lifetime of the Northern Hemisphere polar vortex.

AASE II consisted of four major program elements: a high-altitude ER-2 aircraft; a long-range DC-8 aircraft; extensive meteorological predictions and analyses, which included an array of computational programs to correlate and interpret the aircraft observations; and the TOMS on the Nimbus-7 satellite, which monitored the global distribution of total ozone. The instrument

¹⁴⁹ "Airborne Arctic Stratospheric Expedition II, Mission Statement," <http://cloud1.arc.nasa.gov/aase2/project/statement.html> (accessed February 16, 2006).

¹⁵⁰ Lambright, p. 26.

¹⁵¹ "Airborne Arctic Stratospheric Expedition II, Mission Statement."

¹⁵² Lambright, p. 30.

packages on the two aircraft measured an array of chemical species and other atmospheric parameters associated with the mechanisms that determine the distribution of ozone.¹⁵³

Meteorological analyses from the NOAA National Meteorological Center (NMC) provided the historical context, analysis, and predictive capability for temperature, pressure, and wind fields for the Northern Hemisphere during the field deployment.¹⁵⁴

Three questions defined the principal mission objectives for AASE-II:

- Will significant erosion of stratospheric ozone occur over the Arctic as stratospheric chlorine levels increase during the next decade?
- What were the causes of mid-latitude stratospheric ozone decreases in late fall through early summer, as revealed over the past decade by ground and satellite observations?
- What effects did volcanoes have on the chemical processes governing stratospheric ozone? In particular, could volcano aerosols modify the stratospheric ozone depletion associated with industrial halocarbons?

On January 11, 1992, satellite data indicated high levels of chlorine in the northern latitudes, including regions around such cities as London, Moscow, and Amsterdam. On January 20, an ER-2 flew into the center of a polar vortex, making in situ measurements with instruments that could sample the air outside the aircraft in real time and obtain air samples that could be

¹⁵³ “End of Mission Statement, Second Airborne Arctic Stratospheric Expedition (AASE-II), NASA Headquarters, 30 April 1992, http://code916.gsfc.nasa.gov/Public/Analysis/aircraft/aase2/eom_aaseII.txt (accessed February 16, 2006).

¹⁵⁴ “Airborne Arctic Stratospheric Expedition II, Mission Statement.”

analyzed on the ground later.¹⁵⁵ When analyzed, the air samples showed the highest levels of chlorine monoxide—a compound that plays a critical role in polar ozone destruction—ever measured in the Arctic region. Data from UARS seemed to confirm the findings that chlorine monoxide molecules (thought to be derived primarily from chlorofluorocarbons) were building up in the vortex. This information verified what scientists had hypothesized from the 1989 AASE mission.

Airborne Visible/InfraRed Imaging Spectrometer (AVIRIS)

The AVIRIS project provided calibrated data from an airborne sensor to customers at NASA, NOAA, EPA, and USGS, as well as in academia and industry. Its main objective was to identify, measure, and monitor constituents of Earth’s surface and atmosphere based on molecular absorption and particle scattering signatures. Research was directed toward understanding processes related to the global environment and climate change, and the AVIRIS instrument was used for investigations relating to ecology, mineralogy, forestry, snow hydrology, oceanography, and cloud and atmospheric studies.¹⁵⁶ The instrument was carried on the ER-2 aircraft, which flies at approximately 20 kilometers (12.4 miles) above sea level at a speed of approximately 730 kilometers per hour (454 miles per hour). AVIRIS was the second in a series of imaging spectrometer instruments developed at JPL for Earth remote sensing. It has flown across the United States, as well as in Canada and Europe.

¹⁵⁵ Lambright, p. 30.

¹⁵⁶ “ER-2 No. 908 Is Out of the Shop and Into the Sky,” *Dryden X-Press* 48 (May 27, 1999): 1, [http://www.dfrc.nasa.gov/Newsroom/X-Press/1999/May 16/people.html](http://www.dfrc.nasa.gov/Newsroom/X-Press/1999/May%2016/people.html). Also “What Is AVIRIS?” <http://www.ltid.inpe.br/html/pub/docs/html/aboutAV.htm> (both accessed January 23, 2007).

The 340-kilogram (750-pound) AVIRIS instrument contained 224 different detectors, each with a wavelength sensitive range (or spectral bandwidth) of approximately 10 nanometers (nm), allowing it to cover an entire range between 380 nm and 2,500 nm (see table 2-75). When the data from each detector were plotted on a graph, they yielded a spectrum. Comparison of the resulting spectrum with those of known substances revealed information about the composition of the area being viewed by the instrument.

The AVIRIS scanning mirror swept back and forth in a “whisk-broom fashion,” producing 677 pixels for the 224 detectors on each scan. The pixel size and swath width of the AVIRIS data depended on the altitude at which the data were collected. When collected by the ER-2 (about 20 kilometers above the ground), each pixel produced by the instrument covered an area approximately 20 meters (65.6 feet) diameter on the ground (with some overlap between pixels), thus yielding a ground swath about 11 kilometers (6.8 miles) wide. The ground data were recorded on board the instrument along with navigation and engineering data and the readings from the AVIRIS on-board calibrator. When all of these data were processed and stored on the ground, they yielded approximately 140 megabytes for every 512 scans (or lines) of data. Each 512-line set of data, or scene, corresponded to an area about 10 kilometers (6.2 miles) long on the ground.¹⁵⁷ Through 1994, the instrument had a data rate of 17 Mbps. Beginning in 1995, its data rate increased to 20.4 Mbps.¹⁵⁸

Every time AVIRIS flew, the instrument took several “runs” of data (also known as flight lines). Originally, AVIRIS had an approximately 40-minute recording limit using a reel-to-reel tape

¹⁵⁷ “The AVIRIS Concept,” <http://aviris.jpl.nasa.gov/html/aviris.concept.html> (accessed January 23, 2007).

¹⁵⁸ “AVIRIS Instrument,” <http://aviris.jpl.nasa.gov/html/aviris.instrument.html> (accessed February 1, 2007).

drive. In 1992, it upgraded to a Metrum VLDS recorder, which used VHS-style tape cartridges with a tape capacity of just over an hour. A full AVIRIS tape of this type could yield about 16 gigabytes of data per day.¹⁵⁹ In 1998, AVIRIS upgraded to a Metrum DLT tape drive with a 35-gigabyte capacity, allowing about two hours of data collection.¹⁶⁰ The AVIRIS Data Facility performed low-level processing, data archiving, and data distribution, and assisted the hardware team in judging the performance of the instrument and modeling instrument anomalies.¹⁶¹

AVIRIS began operating in the summer of 1987, with the first engineering/integration test flights using the ER-2 aircraft, three years after design and construction of the instrument began. The first season of operations was dedicated to a NASA-sponsored data evaluation and technology assessment program to determine the full performance potential of the AVIRIS system.¹⁶² An ER-2 deployment in June 1991 to Alconbury, England, brought the instrument to Europe. Multiple flights were flown over Iceland, Wales, England, France, Italy, Spain, Austria, Germany, and the Netherlands. When it returned to the United States, it conducted stratospheric sampling from Eielson Air Force Base, Alaska, to the North Pole.¹⁶³

¹⁵⁹ “The AVIRIS Concept,” <http://www.ltid.inpe.br/html/pub/docs/html/concept.htm> (accessed January 23, 2007).

¹⁶⁰ Michael Eastwood, e-mail to author, February 12, 2007.

¹⁶¹ “The AVIRIS Data Facility,” <http://www.ltid.inpe.br/html/pub/docs/html/adf.htm> (accessed January 23, 2007).

¹⁶² Gregg Vane, editor, *Airborne Visible/Infrared Imaging Spectrometer (AVIRIS): A Description of the Sensor, Ground Data Processing Facility, Laboratory Calibration, and First Results* (Pasadena, CA: Jet Propulsion Laboratory Publication 87-38, 1987), p. 1, ftp://popojpl.nasa.gov/pub/docs/workshops/87_docs/JPLPUB87-38.pdf (accessed January 22, 2007).

¹⁶³ “ER-2 Program History,” <http://www.nasa.gov/centers/dryden/research/AirSci/ER-2/history.html> (accessed January 23, 2007).

TOMS

NASA began using monitors in the 1970s to map the level of ozone in the atmosphere. During the decade from 1989–1998, four TOMS flew—two on NASA spacecraft and two on international spacecraft. Table 2-76 summarizes the four missions.

Nimbus-7 TOMS

The TOMS program began with the launch of TOMS Flight Model #1 on the Nimbus-7 spacecraft on October 24, 1978. Valid measurements started in November of the same year, and the instrument continued to return data until May 1993, long after all other on-board experiments on Nimbus had failed. The Nimbus TOMS provided daily global coverage of Earth's total ozone by measuring backscattered Earth radiance in six 1-nm bands.¹⁶⁴ This instrument offered the first opportunity for NASA and ESA to receive data concerning the global atmosphere in real time.¹⁶⁵ In October 1990, data from TOMS indicated that a hole it had observed earlier in the ozone layer had reopened over Antarctica, and the depletion of ozone there seemed to be nearly as severe as it had been in the worst years of 1987 and 1989.¹⁶⁶ On October 8, 1991, NASA announced that in its 13th year of monitoring ozone with the Nimbus-7 TOMS, preliminary data suggested that 1991 would be the third consecutive year that severe ozone depletion had developed over the Antarctic.¹⁶⁷

¹⁶⁴ Richard D. McPeters et al., "Nimbus-7 Total Ozone Mapping Spectrometer (TOMS) Data Products User's Guide," 5, <http://toms.gsfc.nasa.gov/datainfo/n7usrguide.pdf> (accessed March 1, 2006). Backscattered radiation is solar radiation that has penetrated to the Earth's lower atmosphere. There it is scattered by air molecules and clouds back through the stratosphere to the satellite sensors.

¹⁶⁵ "Nimbus-7, 40+ Years of Earth Science," <http://www.earth.nasa.gov/history/nimbus/nimbus7.html> (accessed March 1, 2006).

¹⁶⁶ Lambright, p. 29.

¹⁶⁷ "1991 Ozone Level Matches Three Previous Years," *NASA News Release 91-165*, October 8, 1991, <ftp://ftp.hq.nasa.gov/pub/pao/pressrel/1991/91-165.txt> (accessed February 13, 2006).

Data relating to global ozone in late 1992 and early 1993 agreed with data from the Solar Backscatter Ultraviolet (SBUV/2) spectral radiometer flying on the NOAA-11 satellite and the TOMS on the Russian Meteor-3 satellite. Scientists from Goddard discovered that global ozone levels during this period were the lowest ever observed, substantially lower than the reduced values that had been predicted for 1992, and some 2–3 percent lower than in any previous year. Ozone amounts were low in a wide range of latitudes in both the Northern and Southern hemispheres, with the largest decreases in the regions from 10°S to 20°S and 10°N to 60°N. The data also agreed with preliminary findings from the Shuttle Solar Backscatter Ultraviolet (SSBUV) instrument flying on the ATLAS-2 mission on the Space Shuttle in April 1993.¹⁶⁸

Meteor-3 TOMS

The Meteor-3 TOMS project was conducted under the 1987 United States–Soviet Union agreement on “Cooperation in the Exploration and Use of Outer Space for Peaceful Purposes,” as amended in May 1988 and the implementation agreement between NASA and the Soviet Union signed on July 25, 1990 to fly a TOMS on the Russian Meteor-3 spacecraft.¹⁶⁹ A TOMS instrument on the Meteor-3 flight would be able to gather critical environmental data about the yearly variability of the ozone hole over Antarctica.¹⁷⁰

¹⁶⁸ *Aeronautics and Space Report of the President, Fiscal Year 1993 Activities*, p. 57. Also J.F. Gleason et al., “Record Low Global Ozone in 1992,” *Science* 206 (April 1993): 523–526, <http://www.ciesin.org/docs/011-427/011-427.html> (accessed March 1, 2006).

¹⁶⁹ “Soviets To Launch NASA Instrument To Study Ozone Levels,” *NASA News Release* 91-127, August 12, 1991, <ftp://ftp.hq.nasa.gov/pub/pao/pressrel/1991/91-127.txt> (accessed March 1, 2006). Also “Agreement Between the United States of America and the Union of Soviet Socialist Republics Concerning Cooperation in the Exploration and Use of Outer Space for Peaceful Purposes, April 5, 1987, revised May 31, 1988 (but the revised version was not enacted), http://www.jaxa.jp/jda/library/space-law/chapter_3/3-2-2-7_e.html (accessed March 1, 2006).

¹⁷⁰ Lambright, p. 29.

NASA refurbished a Nimbus-7 Engineering Model TOMS to flight status, adding an Interface Adapter Model (IAM) to make the TOMS compatible with the Meteor-3. The IAM converted the Meteor-3 power, commands, clock, telemetry, and data interfaces into a system compatible with TOMS. NASA also replaced the diffractions grating, resurfaced the mirrors, added flight-qualified electronics, and replaced the tape recorder that had been used for Nimbus- with a solid-state data recorder. The most significant change was the replacement of the single diffuser plate of Nimbus-7 with a three-diffuser system on Meteor-3. Aside from the change in the diffuser, the optics of the Meteor TOMS had the same optics as the Nimbus-7 TOMS.¹⁷¹

The Meteor-3 carrying TOMS launched on a Soviet Cyclone ELV from the Plesetsk facility near the White Sea on August 15, 1991. It was the first U.S.-built remote-sensing instrument, and the first NASA instrument of any kind, to fly on a Soviet spacecraft.¹⁷² Unlike Nimbus-7, the Meteor-3 orbit was not Sun-synchronous but had a precession period of 212 days.¹⁷³ The instrument measured the solar irradiance and the radiance backscattered by Earth's atmosphere in six selected wavelength bands in the ultraviolet region.¹⁷⁴

Data from the Meteor-3 TOMS were gathered from August 22, 1991, to December 27, 1994, which was the last day useful data were received. At the time, spacecraft telemetry indicated a lack of steady electrical current to the instrument's chopper motor. Attempts to revive the

¹⁷¹ Jay R. Herman et al., "Meteor-3 Total Ozone Mapping Spectrometer (TOMS) Data Products User's Guide," Goddard Space Flight Center, Scientific and Technical Information Branch, NASA Reference Publication, 1996, p. 5, <http://jwocky.gsfc.nasa.gov/datainfo/m3usrguide.pdf> (accessed January 10, 2006).

¹⁷² "Total Ozone Mapping Spectrometer, Ozone Processing Team—NASA/GSFC Code 613.3, Meteor-3 TOMS Instrument and Satellite Information <http://jwocky.gsfc.nasa.gov/m3toms/m3sat.html> (accessed January 18, 2007). Also e-mail to author from Arlin Krueger, NASA TOMS scientist (retired) and proposer of TOMS instrument, January 19, 2007.

¹⁷³ Herman et al., p. 5.

¹⁷⁴ Herman et al., p. 1.

instrument failed.¹⁷⁵ The Meteor-3 TOMS data were archived at the Goddard Distributed Active Archive Center.

TOMS-Earth Probe and ADEOS TOMS

NASA launched a small EP spacecraft carrying TOMS-EP from a Pegasus XL launch vehicle in July 1996. Although the sensor had been ready for launch earlier, launch failures of the first two Pegasus XL vehicles led to a two-year delay, causing the mission to fly at the same time as the TOMS on the Japanese ADEOS. Consequently, the mission was altered and TOMS-EP was placed into a lower orbit than previously planned so that researchers could achieve higher-resolution measurements and study ultraviolet-absorbing aerosols in the troposphere more thoroughly. The lower orbit complemented measurements taken from the ADEOS TOMS, launched only a month later, in August 1996.¹⁷⁶

TOMS-EP was a second-generation backscatter ultraviolet ozone sounder that provided high-resolution global mapping of total ozone on a daily basis. It measured “total column ozone” (the total amount of ozone in a “column” of air from Earth’s surface to the top of the atmosphere) under all daytime observing and geophysical conditions. Like the earlier instruments, TOMS covered the near-ultraviolet region of the electromagnetic spectrum, where sunlight was absorbed only partially by ozone.

¹⁷⁵ “Successful U.S.-Russian Ozone-Monitoring Mission Appears Over,” *NASA News Release 95-11*, February 2, 1995, <ftp://ftp.hq.nasa.gov/pub/pao/pressrel/1995/95-11.txt> (accessed January 10, 2006).

¹⁷⁶ “Earth Probe TOMS (Total Ozone Mapping Spectrometer,” Ozone Processing Team—NASA/GSFC Code 613.3, <http://jwocky.gsfc.nasa.gov/eptoms/eptech2.html> (accessed March 1, 2006).

TOMS-EP measured total ozone by observing both incoming solar energy and backscattered ultraviolet radiation at six wavelengths. Every 8 seconds it made 35 measurements, each covering an area 30–125 miles (50–200 kilometers) wide on the ground along a line perpendicular to the motion of the satellite. Almost 200,000 daily measurements covered every spot on Earth except areas near the poles, where the Sun remained close to or below the horizon during the entire 24-hour period. In addition to housekeeping sensors to monitor the well-being of the instrument, TOMS-EP used several inflight calibration modes to assess system performance.¹⁷⁷ Figure 2-18 shows global ozone on July 25, 1996, one of the first days that data were received from TOMS-EP.

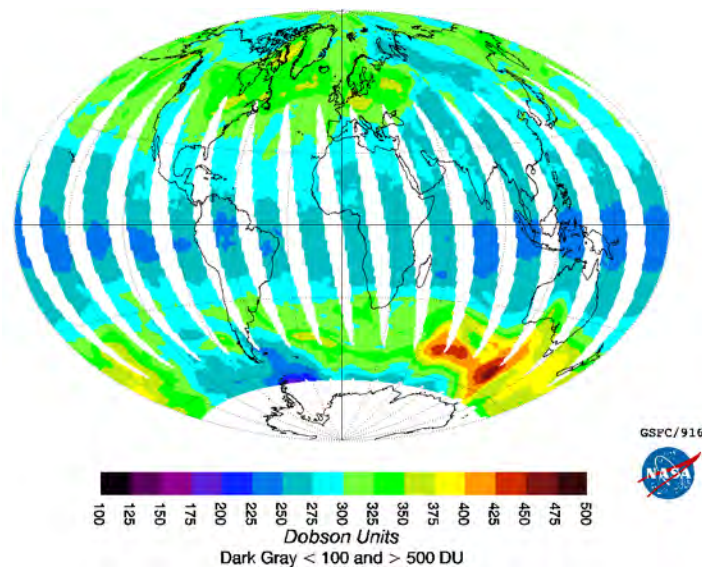

Figure 2-18. Global ozone for 25 July 25, 1996, as detected by TOMS-EP. (GSFC/Code 916).

New analysis techniques developed for earlier TOMS data provided the first global dataset on surface ultraviolet radiation. These results documented the first confirmation of global trends in

¹⁷⁷ “Total Ozone Mapping Spectrometer/Earth Probe,” NASA Facts, September 22, 1997, http://www.gsfc.nasa.gov/gsfcservice/gallery/fact_sheets/earthsci/toms.htm (accessed March 1, 2006).

increasing ultraviolet radiation related to stratospheric ozone depletion and provided the basis for improved assessments of the effects on health. Atmospheric ozone studies indicated a promising response to policy actions such as the Montreal Protocol, a 1987 agreement that challenged its international signatories to adopt rigorous environmental standards. NASA and NOAA ground-based measurements documented a continued decrease in the growth of ozone-depleting industrial chemicals in the lower atmosphere, confirming industry's response to the Montreal Protocol. From these results, scientists expected stratospheric ozone to reach a minimum within the next decade and then begin to recover. In addition, NASA cooperated with private industry researchers to verify the environmental acceptability of the chemicals used to replace chlorofluorocarbons.

TOMS-EP continued to be one of NASA's most successful environmental programs, extending a 15-year database of global ozone levels. TOMS data, along with data from aircraft and ground-based research, were instrumental in creating international agreements to phase out the use of ozone-destroying chemicals in many industries.

ADEOS, carrying a TOMS and the NSCAT, launched in August 1996. This TOMS provided its first global total ozone image on September 13, 1996. On October 7, 1996, near-real-time ADEOS-TOMS data became available on the TOMS Web site. The ADEOS TOMS, along with TOMS-EP, observed the unusual loss of Arctic polar ozone. TOMS-EP also provided high-ground-resolution research data from its lower orbit to complement global data from the

spectrometer on ADEOS. The ADEOS-TOMS instrument performed well until June 1997, when the ADEOS satellite failed. The spacecraft was declared lost on June 30, 1997.¹⁷⁸

After ADEOS failed, NASA chose TOMS-EP in December 1997 to monitor ozone trends for an additional three years, filling the gap left by the loss of ADEOS. A series of thruster burns over nine days boosted TOMS-EP into a 740-kilometer (460-mile) Sun-synchronous orbit from its 490-kilometer (320-mile) orbit, making possible contiguous Earth coverage for monitoring ozone and volcanic eruption clouds.¹⁷⁹ The higher altitude widened the coverage of TOMS and exerted less atmospheric drag on the satellite, enabling it to continue providing measurements into the next decade, well beyond its two-year design life.¹⁸⁰

Tropical Rainfall Measuring Mission

TRMM was the first mission dedicated to measuring tropical and subtropical rainfall through microwave and visible infrared sensors; and it included the first space-borne rain radar.¹⁸¹

Tropical rainfall comprises more than two-thirds of global rainfall and is the primary distributor of heat through the atmosphere. Understanding rainfall and how it varies is crucial for understanding and predicting global climate change.

TRMM was first proposed in the mid-1980s as a satellite project to be jointly conducted by Japan and the United States. Early in 1984, the NASA Headquarters atmospheric program

¹⁷⁸ “ADEOS Operations Status Report Meeting,” Earth Observation Center, Japan Space Exploration Agency, <http://suzaku.eorc.jaxa.jp/GLI2/adeos/NewsLetters/newsletter10/status.html> (accessed May 23, 2007).

¹⁷⁹ “NASA Mission to Planet Earth (MTPE), Education Program Update-July 1997,” <http://science.hq.nasa.gov/education/edreports/mtpeedjul97.html> (accessed February 1, 2007).

¹⁸⁰ “NASA Redeploys Ozone Monitoring Satellite,” *SpaceDaily*, December 17, 1997, <http://www.spacedaily.com/spacenet/text/adeos-j.html> (accessed March 2, 2006).

¹⁸¹ “TRMM Background,” http://tsdis.gsfc.nasa.gov/tsdis/tsdis_redesign/TRMMBackground.html (accessed January 12, 2006).

manager had held an informal competition for an inexpensive space mission that could answer focused science questions about the atmosphere and Earth environment. The winner, TRMM, was proposed by scientists at GSFC. In 1985, when the United States conducted aircraft experiments together with Japan, it became clear that the two countries were both interested in measuring rain from space. The U.S. and Japan agreed that Japan would build the Precipitation Radar instrument to fly on TRMM and provide the launch services with an H-II rocket, while the United States would provide the spacecraft and passive microwave and visible/infrared (VIS/IR) sensors.¹⁸²

In 1987, a feasibility study was performed, and development of a model began in 1988, continuing until 1993. In 1988, the TRMM Science Steering Group (SSG) issued a report called “TRMM: A Satellite Mission to Measure Rainfall,” as well as a shorter summary. The SSG report included the science background, requirements and “desirements,” ground truth validation plan, goals, and specific questions the mission was to address. It spelled out specifications of the rain instruments and suggested how they might complement each other.¹⁸³

In late 1990, pressure exerted by the science community led to a congressional initiative to budget for a TRMM “new start” in 1991. TRMM was designated as one of the first missions in NASA’s Earth Probeseries, which was part of MTPE. In 1991, the TRMM project was staffed and organized, GSFC began the in-house design of the spacecraft, and the first science team of 31 scientists was selected from more than 100 proposals submitted in response to a NASA research announcement.

¹⁸² J. Simpson et al., “On the Tropical Rainfall Measuring Mission (TRMM), *Meteorology and Atmospheric Physics*, 60 (1996): pp. 4–7, http://rain.atmos.colostate.edu/papers/kummerow/J_Simpson.pdf (accessed February 27, 2006). Also “NASA’s Mission to Planet Earth: Space-Based Missions, 1994–2000,” NASA Facts, February 1994, NASA History Division folder 18482, Historical Reference Collection, NASA Headquarters, Washington, DC.

¹⁸³ Simpson et al., pp. 4–7.

NASA began instrument development in 1991, and the instrument complement evolved between 1991 and 1994. The TRMM observatory entered its integration and test phase in early 1995.¹⁸⁴

On October 20, 1995, Japan and the United States signed a memorandum of understanding for TRMM, making the joint program official and stating the responsibilities of each party.¹⁸⁵ Soon after, technicians integrated the spacecraft and payload of five instruments and began testing.¹⁸⁶ In 1997, NASA completed instrument integration and delivered the satellite to Japan. Launch took place on November 27, 1997 from the Japanese Tanegashima Space Facility. Goddard developed and constructed the observatory, provided four instruments, integrated and tested the observatory, and operated the satellite via the TDRSS. TRMM was the largest spacecraft ever built in-house at Goddard.¹⁸⁷ The spacecraft had a design lifetime of three years but continued to operate into the next decade.

TRMM provided unprecedented insights into rainfall cloud systems in the tropics and subtropics. TRMM's all-weather sea-surface temperature data from September 1998 indicated a possibly waning La Niña event, a cooling phase of El Niño. In August 1998, TRMM provided spectacular images of Hurricane Bonnie over the Atlantic Ocean by capturing towering clouds extending up to 59,000 feet (17,983 meters) above the hurricane's eye. Earth scientists also completed an experiment (the third Convection and Moisture Experiment [CAMEX-3]) off the coast of

¹⁸⁴ Simpson et al.: 14.

¹⁸⁵ "Second Joint Tropical Rainfall Measuring Mission (TRMM) Science Team Meeting, *The Earth Observer* 8, no. 2 (March/April 1996), http://eosps0.gsfc.nasa.gov/eos_observ/3_4_96/p15.html (accessed February 27, 2006). Also Subcommittee on Global Change Research, Committee on Environment and Natural Resources Research of the National Science and Technology Council, *Our Changing Planet FY 1996; The FY 1996 U.S. Global Change Research Program*, <http://www.gcrio.org/ocp96/ch3.html> (accessed February 27, 2006).

¹⁸⁶ *Aeronautics and Space Report of the President, Fiscal Year 1996 Activities*, p. 68.

¹⁸⁷ "Tropical Rainfall Measuring Mission (TRMM) Source Document," http://ghrc.msfc.nasa.gov:5721/source_documents/trmm_source.html (accessed January 18, 2007).

Florida, based at Patrick Air Force Base, from August 6 to September 23, 1998. CAMEX-3 successfully studied hurricanes Bonnie, Danielle, Earl, and Georges, collecting data for research on tropical cyclone development, tracking intensification, and landfalling impacts and measuring. It also measured the hurricanes' structure, environment, and changes in intensity.¹⁸⁸

TRMM's orbit ranged between 35°N and 35°S, which allowed the spacecraft to fly over each position on Earth's surface at a different local time each day. Scientists used data from this orbit to calculate rain variations over a 24-hour period to provide a dataset that was vastly more informative than any previously available. Figure 2-19 shows a drawing of the on-orbit spacecraft. Table 2-77 provides further mission information.

¹⁸⁸ *Aeronautics and Space Report of the President, Fiscal Year 1998 Activities* (Washington, DC: National Aeronautics and Space Administration, [no date]), p. 6. Also "3rd Convection and Moisture Experiment," <http://ghrc.msfc.nasa.gov/camex3> (accessed January 18, 2007).

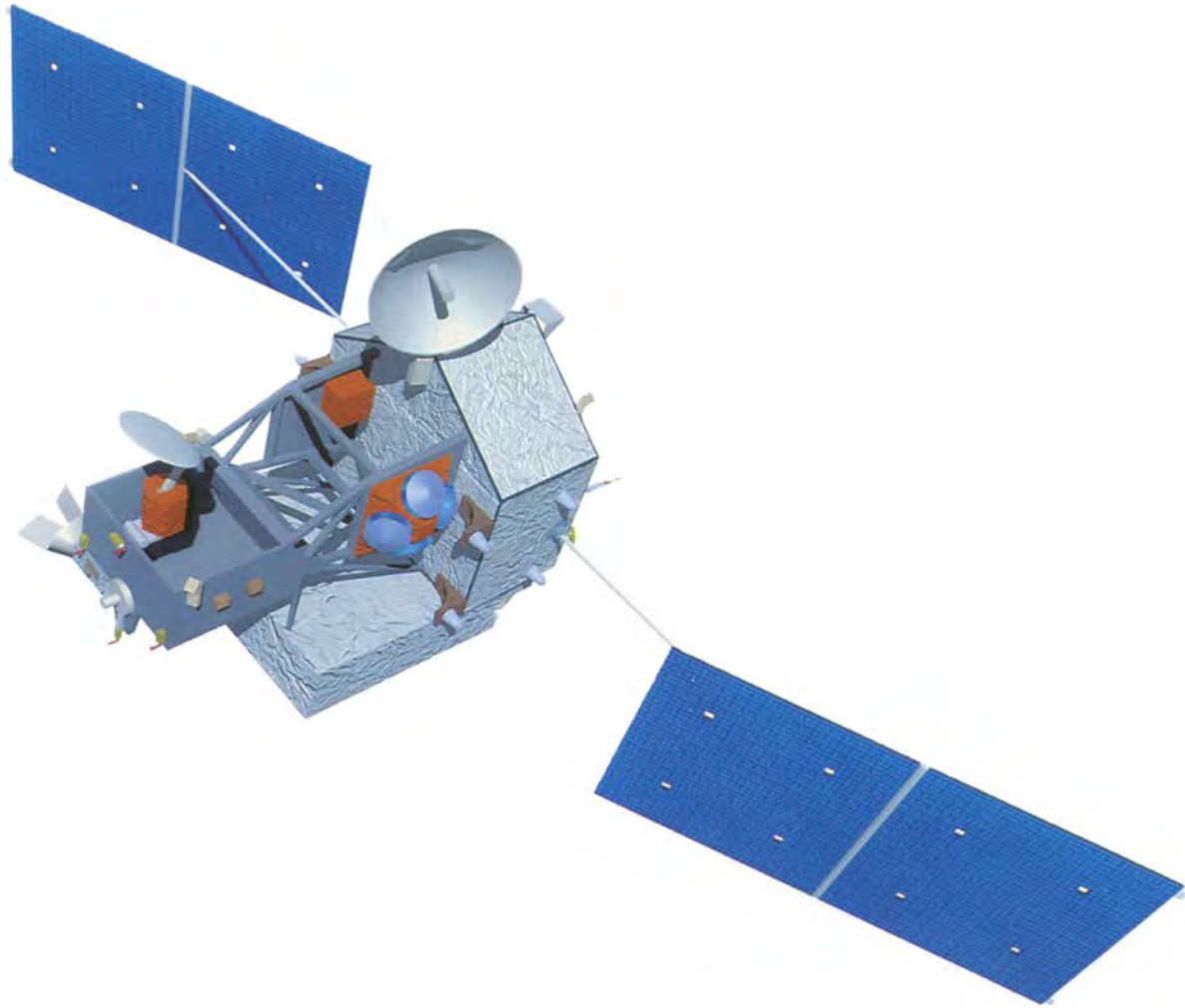

Figure 2-19. TRMM on-orbit configuration (TRMM project/GSFC).

Airborne Southern Hemisphere Ozone Experiment/Measurements for Assessing the Effects of Stratospheric Aircraft (ASHOE/MAESA)

The ASHOE/MAESA mission consisted of a series of high-altitude flights by NASA ER-2 aircraft in 1994. The flights obtained the first inflight measurements of the exhaust gases and particles produced by a supersonic aircraft.¹⁸⁹ The mission's primary objective was to investigate the causes of long-term reductions of ozone in the wintertime mid-latitudes in the Southern

¹⁸⁹ "FY96 Annual Operating Plan," NOAA Aeronomy Laboratory, <http://www.al.noaa.gov/plans/planstextfy96.html> (accessed January 22, 2007).

Hemisphere, which had been observed by ground-based measurements and satellites for the last 15 years. To meet this objective, ER-2 flights were designed to observe several aspects of ozone loss: the rapid ozone decline over Antarctica, the spread of this ozone-poor air to the mid-latitudes, and the activation of ozone-destroying chlorine directly in the mid-latitudes by reactions on sulfate aerosols. The observations also allowed researchers to determine the rate of chemical ozone destruction by reactive trace chemicals in the nitrogen, hydrogen, chlorine, and bromine chemical families and to test the amount of these chemicals in the reactive forms. Some flights focused on observations to study the mixing of air between the mid-latitudes and tropics because that process helped establish ozone distributions and rates of ozone change.¹⁹⁰

The second objective was to obtain measurements to assess the atmospheric effects of future supersonic (high-speed civil transport) aircraft then being considered.¹⁹¹ ASHOE investigated the causes of lower stratospheric ozone loss in the Southern Hemisphere in the last 15 years to determine how the loss was related to polar, mid-latitude, and tropical processes. The MAESA campaign, conducted in parallel with ASHOE, focused on evaluating the potential environmental effects of emissions from a proposed fleet of high-altitude civilian aircraft.

The mission was sponsored by NASA's Upper Atmosphere Research Program and High Speed Research Program. NOAA and the NSF contributed, as did the meteorological services of New Zealand, Australia, the United Kingdom, and others who signed the convention governing the European Centre for Medium-Range Weather Forecasts.¹⁹²

¹⁹⁰ "ASHOE/MAESA End of Mission Summary of Preliminary Results," http://code916.gsfc.nasa.gov/Public/Analysis/aircraft/ashoe/eom_ashoe.txt (accessed January 20, 2007).

¹⁹¹ "ASHOE/MAESA Mission Statement," http://cloud1.arc.nasa.gov/ashoe_maesa/project/statement.html (accessed March 3, 2006).

¹⁹² "ASHOE/MAESA Mission Statement," http://cloud1.arc.nasa.gov/ashoe_maesa/project/statement.html (accessed March 3, 2006).

The aircraft carried as many as 16 instruments that provided new observations to diagnose the chemistry, physics, and fluid motion of air in the lower stratosphere. Measurements spanned February to November 1994, and from the edge of Antarctica at 70°S to upper Canada at 60°N, in conjunction with observations from the ground, balloons, and satellites, particularly the MLS and HALOE on UARS, and the TOMS on Meteor-3. Forty-five ER-2 flights were made.

Researchers used ASHOE data to investigate aspects of global atmospheric circulation and the transport of gases from the lower atmosphere to the stratosphere. The findings showed a smaller percentage of mid-latitude air in the tropical ascent region than global models had assumed, which suggested that ozone-layer reductions caused by a future fleet of supersonic transport aircraft would be smaller than was generally predicted. The findings also suggested that stratospheric ozone at the mid-latitudes might be more sensitive to depletion by halocarbons than many models currently predicted.¹⁹³

Observations from ASHOE/MAESA would be used to improve understanding of the processes leading to the Antarctic ozone hole and to ozone loss at the mid-latitudes. These processes include the formation of polar stratospheric clouds, the conversion of chlorine from its reservoir forms to its ozone-destroying reactive form on cold sulfate aerosols, and the return of chlorine to its inactive forms after all ozone is destroyed inside the ozone hole. The transport mechanisms redistributing the effects of these chemical processes, as well as the detailed mechanisms of the processes themselves, would also be better understood. This helped improve the numerical models used to simulate the stratosphere. Simultaneous measurement of reactive hydrogen,

¹⁹³ “FY 96 Annual Operating Plan,” NOAA Aeronomy Laboratory, <http://www.al.noaa.gov/plans/planstextfy96.html> (accessed January 22, 2007).

reactive chlorine, and reactive bromine showed that these species destroyed ozone faster in the lower stratosphere than did reactive nitrogen in the chlorine-laden stratosphere of the 1990s. Reactive nitrogen was then thought to be dominant only higher in the stratosphere, above altitudes sampled by the ER-2. Thus, the calculated effect of High Speed Civil Transport (HSCT) exhaust on ozone was small ozone increases in the lower stratosphere. The importance of reactions on sulfate aerosols that converted reactive nitrogen to reservoir forms was confirmed for a stratosphere with the low aerosol amounts characteristic of the period three or more years after a major volcanic eruption.¹⁹⁴

Meteorological Satellites

NASA and NOAA launched and operated two series of meteorological satellites during the decade from 1989 to 1998: a series of polar-orbiting satellites (given the name “NOAA”) and the Geostationary Operational Environmental Satellites. NASA was responsible for procuring and developing the spacecraft, instruments, and associated ground stations; launching the spacecraft; and conducting on-orbit checkout of the spacecraft. NOAA had responsibility for establishing the operational requirements and operating the system.¹⁹⁵ NASA’s Polar-Orbiting Operational Environmental Satellite (POES) project managed the polar-orbiting satellites. The GOES project managed the geostationary satellites. Both were headquartered at Goddard.

Polar-orbiting Operational Environmental Satellites

The POES system (the “NOAA” series) consisted of a pair of orbiting satellites operating in low-Earth orbit. These satellites provided global coverage of numerous atmospheric and surface parameters that affect weather and climate, and furnished quantitative measurements for input to

¹⁹⁴ “ASHOE/MAESA Mission Statement,” http://cloud1.arc.nasa.gov/ashoe_maesa/project/statement.html (accessed January 22, 2007).

¹⁹⁵ *Aeronautics and Space Report of the President, 1989–1990 Activities*, p. 22.

global atmospheric and surface forecast models. They collected global data on cloud cover; surface conditions such as ice, snow, and vegetation; atmospheric temperatures and moisture; and aerosol and ozone distributions. They also collected and relayed information from fixed and moving data platforms. (See figure 2-20 for an example of a sea-surface temperature product.) Beginning in 1982, the satellites also supported an international search-and-rescue program that was credited with saving thousands of lives by detecting and locating emergency beacons from ships, aircraft, and people in distress.¹⁹⁶ Between 1989 and 1998, NASA launched four polar-orbiting meteorological satellites: NOAA-12 (D), NOAA-13 (I), NOAA-14 (J), and NOAA-15 (K).¹⁹⁷

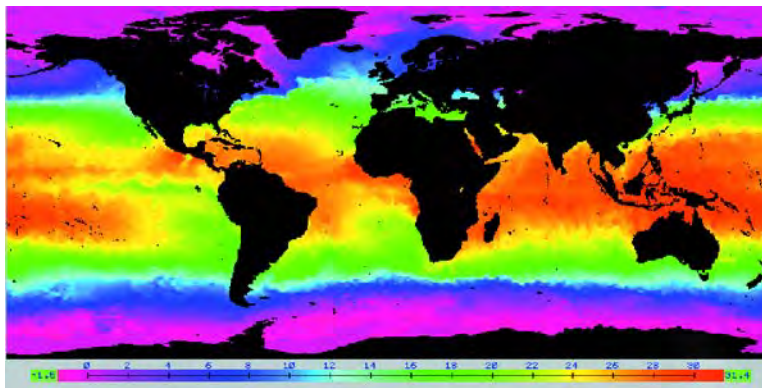

Figure 2-20. This image shows a sea surface temperature product produced from the NOAA-14 satellite. It is an example of a global product produced at 50-km (31-mi) resolution, available twice weekly (NOAA).

The NOAA series of satellites circled Earth in a near-polar orbit. As Earth rotated beneath them, each satellite viewed Earth's entire surface twice a day, with the two-satellite system viewing every part of Earth at least twice every 12 hours. Each satellite made about 14 orbits a day. One satellite was designated the "morning satellite," meaning that it crossed over the Northern

¹⁹⁶ "NOAA-N," Goddard Space Flight Center, NP-2004-8-666-GSFC, p. 4.

¹⁹⁷ Spacecraft are first given a letter designation, e.g., NOAA-D. They receive a number, e.g., NOAA-12, when they achieve orbit.

Hemisphere traveling from north to south during the morning. The second satellite was called the “afternoon satellite,” meaning that it crossed the Northern Hemisphere traveling in a northward direction during the afternoon. Besides the two operational satellites, older satellites in orbit still collected some data and were available to provide limited backup to the operational satellites should they degrade or fail. Each satellite carried a suite of instruments that collected global data. The instruments carried on NOAA satellites are summarized in table 2-78.

NOAA-12 (NOAA-D)

NOAA-12 was launched May 14, 1991—replacing NOAA-10, which had been orbiting since September 1986—in the morning orbit. It crossed the equator at 7:30 a.m. southbound and 7:30 p.m. northbound, local solar time. NOAA-12 was the last of the Television Infrared Operational Satellite (TIROS)-N-class spacecraft and was shorter in length than the spacecraft in the follow-on Advanced TIROS-N (ATN) series. It also did not have a search-and-rescue package.¹⁹⁸ The instrument systems provided both direct readout and on-board recording and playback of environmental data during day and night operations. NOAA-12 carried five primary instruments: the AVHRR/2, HIRS/2, SEM, MSU, and Argos DCS. NOAA-12 operated until it was placed in standby mode on 14 December 1998, when NOAA-15 became operational.

Operational ground facilities included command and data-acquisition stations in Fairbanks, Alaska, and Wallops Island, Virginia; the Satellite Operations Control Center and data-processing services subsystem facilities in Suitland, Maryland; and a data-receiving station in Lannion, France. The U.S. Air Force (USAF) provided launch support with its Atlas-E launch

¹⁹⁸ Earlier spacecraft in the TIROS-N series were NOAA-6 and NOAA-7.

vehicle, built by the Space Systems Division of General Dynamics.¹⁹⁹ See table 2-79 for further mission information.

NOAA-13 (NOAA-I)

NOAA-13 was launched August 9, 1993 from Vandenberg Air Force Base, California, into an afternoon orbit. On August 21, 1993, the spacecraft suffered a power system anomaly. The spacecraft had operated normally on orbit 175, but when controllers communicated with the spacecraft on orbit 177, they noted low-voltage and high-temperature flags on all three batteries—the first indications of a problem. No further signals from the satellite were received, and all attempts to contact or command the spacecraft were unsuccessful. According to the report of an investigating board, released in September 1994, the probable cause of the failure was a short circuit that prevented the solar array current from powering the spacecraft and recharging the batteries. The board indicated that the most probable cause was a 1.25-inch (3.2-centimeter) screw that extended too far below an aluminum plate designed to dissipate heat. The screw end penetrated the insulation and made contact with a radiator plate, causing the short circuit.²⁰⁰

Since the failure of NOAA-13 occurred only two weeks after launch, the spacecraft was never declared operational. Other NOAA spacecraft in the constellation continued to provide data until they were replaced by later spacecraft.

¹⁹⁹ “NASA To Launch NOAA-D Meteorological Satellite,” *NASA News Release 91-72*, May 9, 1991, <ftp://ftp.hq.nasa.gov/pub/pao/pressrel/1991/91-060.txt> (accessed February 22, 2006).

²⁰⁰ “Investigation Panel Releases Report on NOAA-13 Failure,” *NASA News Release 94-157*, September 20, 1994, <ftp://ftp.hq.nasa.gov/pub/pao/pressrel/1994/94-157.txt> (accessed February 23, 2006).

NOAA-13 was an Advanced TIROS-N (ATN) spacecraft. The ATN spacecraft was a “stretched” version of the earlier TIROS-N spacecraft and provided growth capability, particularly additional instruments. A principal operating feature of the ATN series was the centralized remote control of the satellite through the command and data-acquisition stations at Fairbanks, Alaska, and Wallops Island, Virginia, by NOAA’s National Environmental Satellite, Data, and Information Service (NESDIS) Satellite Operations Control Center (SOCC), located at Suitland, Maryland.²⁰¹ See table 2-80 for further mission information.

NOAA-14 (NOAA-J)

NASA successfully launched the NOAA-J satellite on 30 December 1994 from Vandenberg Air Force Base, California. This satellite, which was renamed NOAA-14 once it achieved orbit, assumed the role as the primary afternoon spacecraft in the polar-orbiting satellite constellation, replacing NOAA-11. Following the initial spacecraft checkout, NOAA-14 assumed full operational capability in June 1995. The spacecraft provided temperature and humidity profiles for weather forecasting, imagery for cloud/frontal/snow cover analysis, warnings of tropical cyclones and volcanic eruptions, data for sea-surface temperature and ice analysis, and vegetation indices for climate and global change.²⁰²

NOAA-14 was an ATN spacecraft. It carried seven scientific instruments and two search-and-rescue instruments. The instruments on board were the AVHRR; SBUV/2; the TOVS suite consisting of the SSU, HIRS/2I, and MSU; the SEM; and the DCS. The two search-and-rescue instruments were the SARR and the SARP with memory (SARM). NOAA-14 joined NOAA-9

²⁰¹ “Advanced TIROS-N (ATN), NOAA-J,” p. 19.

²⁰² *Aeronautics and Space Report of the President, Fiscal Year 1995 Activities*, pp. 60–61.

(launched in December 1984), NOAA-10 (launched in September 1986), NOAA-11 (launched in September 1988), and NOAA-12 (launched in May 1991) in polar orbit. See table 2-81 for further mission information.

NOAA-15 (NOAA-K)

NOAA-15, was launched on May 13, 1998, from Vandenberg Air Force Base, California. It replaced NOAA-12 on December 14, 1998, as the primary morning spacecraft.²⁰³

This spacecraft was the first in an improved series of polar-orbiting satellites with better imaging and sounding capabilities. The Microwave Sounding Unit (MSU) and Stratospheric Sounding Unit (SSU) were replaced by the Advanced Microwave Sounding Unit-A (AMSU-A) and AMSU-B, dedicated microwave instruments that generated temperature, moisture, surface, and hydrological products in cloudy regions where visible and infrared instruments had decreased capability. The AMSU instruments had better spatial resolution and upper atmospheric sounding capabilities than the previous MSU.²⁰⁴

The AVHRR, HIRS, Argos DCS, and SEM also added new capabilities. The AVHRR/3 provided spectral and gain changes to the visible channels allowing improved low-energy light detection and added a sixth channel at 1.6 microns for improved snow and ice discrimination.²⁰⁵

Channel 3A was time-shared with the previous 3.7-micron channel, now designated 3B, to provide five channels of continuous data. An external Sun shield and an internal baffle were

²⁰³ “NOAA-L,” National Aeronautics and Space Administration, National Oceanic and Atmospheric Administration, NASA Publication-2000-3-025-GSFC, p. NOAA-L/24.

²⁰⁴ “The NOAA-K, -L, -M Satellites,” <http://www.wmo.ch/web/sat/en/ap9-13.htm> (accessed February 23, 2006).

²⁰⁵ “The NOAA-K, -L, -M Satellites,” <http://www.wmo.ch/web/sat/en/ap9-13.htm> (accessed February 23, 2006).

added to reduce sunlight impingement into the instrument's optical cavity and detectors.²⁰⁶

Figure 2-21 shows a drawing of the spacecraft.

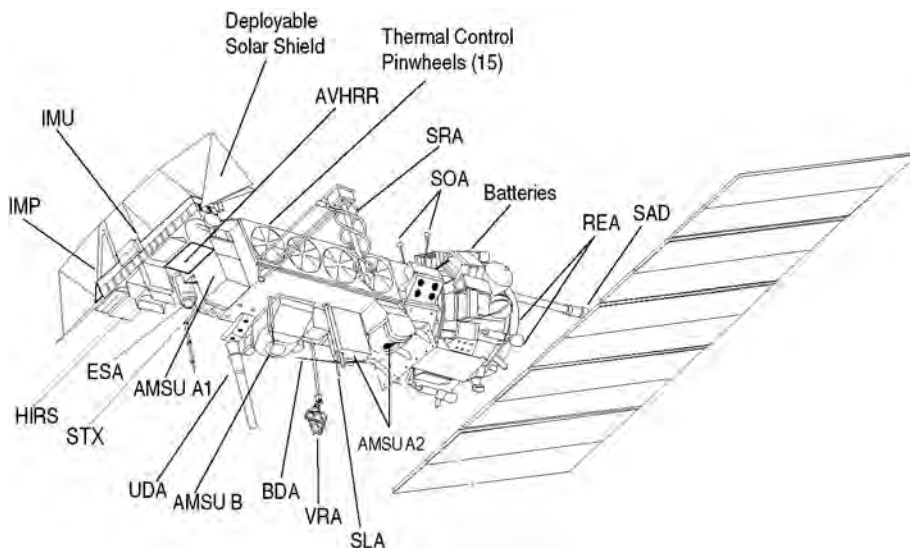

Figure 2-21. NOAA-15 configuration (“NOAA-K,” NASA/NOAA, NASA Publication-1997-12-052-GSFC).

The scan profile on HIRS/3 was modified to eliminate the viewing of the cold blackbody internal calibration target from the automatic calibration sequence. The additional time was used to perform another scan (38 per calibration sequence) of Earth. The DCS/2 increased the data transmission rate and the number of on-board data recovery units. The SEM-2 added inflight calibration capabilities and improved particle detection. The TED measured to a lower energy, and the MEPED added a fourth omnidirectional proton sensor. Also, the telemetry stream included more data.²⁰⁷

²⁰⁶ “NOAA-K,” National Aeronautics and Space Administration, National Oceanic and Atmospheric Administration, NASA Publication-1997-12-052-GSFC, p. NOAA-K/4.

²⁰⁷ “NOAA-K (NOAA-15): A Brief Overview of Changes,” NOAA Polar Satellite Information, <http://www.osdpd.noaa.gov/EBB/ml/nic121.html> (accessed February 23, 2006).

The Solar Backscatter Ultraviolet Radiometer was not carried on this mission.

See table 2-82 for further mission information.

National Polar-Orbiting Operational Environmental Satellite System (N-POESS)

Since the 1960s, the United States operated separate civil and military polar-orbiting environmental satellites that collected, processed, and distributed remotely sensed meteorological, oceanographic, and space environmental data. NASA and NOAA were responsible for the civil Polar-Orbiting Satellite program, which included collecting atmospheric data for weather forecasting, global climate research, and emergency search-and-rescue purposes. NASA had responsibility for designing, engineering, and procuring the satellites and launch services. Once a satellite was launched and checked out, it was turned over to NOAA for operations. DOD was responsible for DMSP. The mission of the DMSP was to collect and distribute global visible and infrared cloud data and other specialized meteorological, oceanographic, and solar geophysical data in support of military operations. NASA, through the development efforts of EOS, provided new remote sensing and spacecraft technologies with the potential to improve satellite operational capabilities.²⁰⁸

In 1992, a National Space Council study recommended convergence of the two separate weather satellite systems.²⁰⁹ The National Performance Review, created by President Bill Clinton in March 1993 and led by Vice President Al Gore, encouraged federal agencies to find more effective ways of operating. Its report called for converging the two operational satellite

²⁰⁸ The White House, Office of the Press Secretary, “Fact Sheet—Convergence of U.S. Polar Orbiting Operational Environmental Satellite Systems, 10 May 1994, <http://www.fas.org/spp/military/docops/national/cnvrgrpf.htm> (accessed February 24, 2006).

²⁰⁹ “The National Polar-orbiting Operational Environmental Satellite System (NPOESS),” <http://www.publicaffairs.noaa.gov/grounders/npoess.html> (accessed February 23, 2006).

programs—POES and DMSP—and incorporating appropriate aspects of EOS to reduce costs and duplication of effort.²¹⁰ In 1993, NOAA, NASA, and DOD initiated studies to determine how to converge the two systems. The completed study stated that a converged system could reduce agency duplication and bureaucracy, substantially reduce costs, and satisfy both civil and military requirements for operational, space-based, remotely sensed environmental data. This tri-agency study formed the basis for development of the Implementation Plan for a Converged Polar-orbiting Environmental Satellite System issued in conjunction with the 1994 Presidential Decision Directive NSTC-2 signed by President Clinton on May 5, 1994. The plan and presidential directive called for a National Polar-orbiting Operational Environmental Satellite System (NPOESS). On October 3, 1994, NOAA, NASA, and DOD created an Integrated Program Office (IPO) to develop, manage, acquire, and operate NPOESS.²¹¹

The IPO concept provided each of the participating agencies with lead responsibility for one of three primary functional areas. NOAA had overall responsibility for the converged system and was also responsible for satellite operations. NOAA was also the primary interface with the international and civil user communities. DOD was responsible for supporting the IPO for major systems acquisitions, including launch support. NASA had primary responsibility for facilitating

²¹⁰ Al Gore, *From Red Tape to Results: Creating a Government That Works Better and Costs Less*, Report of the National Performance Review, September 7, 1993, Appendix A, Major Recommendations by Agency, <http://govinfo.library.unt.edu/npr/library/nprprt/annrpt/redtpe93/259e.html> (accessed February 23, 2006). Also The White House, Office of the Press Secretary, “Fact Sheet—Convergence of U.S. Polar Orbiting Operational Environmental Satellite Systems, May 10, 1994,” <http://www.fas.org/spp/military/docops/national/cnvrgrpf.htm> (accessed February 24, 2006).

²¹¹ “The National Polar-orbiting Operational Environmental Satellite System (NPOESS),” <http://www.publicaffairs.noaa.gov/grounders/npoess.html> (accessed February 23, 2006).

the development of new cost-effective technologies and incorporating them into the converged system.²¹²

The primary tangible result of the NPOESS effort through 1998 was the transfer of Satellite Control Authority for the existing DMSP satellites from the USAF Space Command to the NPOESS IPO in May 1998.²¹³ The command, control, and communications functions for the DMSP satellites were combined with the control for NOAA's POES satellites at NOAA's Satellite Operations Control Center in Suitland, Maryland, and the DMSP satellites were "flown" by civilian personnel. This was the first time in the 40-year history of this DOD program that the DMSP satellites were not flown by USAF personnel. The transfer of DMSP operations was accomplished in less than four years, on budget, and allowed the USAF to close DMSP satellite operations control facilities at Fairchild Air Force Base, Washington, and Offutt Air Force Base, Nebraska, three months ahead of schedule. A backup satellite operations center, staffed by USAF Reserve personnel, was established at Schriever Air Force Base, Colorado. This interagency team effort provided the U.S. government with new, state-of-the-technology satellite control equipment and resulted in significant cost savings as well as uninterrupted service to the end users.²¹⁴

²¹² The White House, Office of the Press Secretary, "Fact Sheet—Convergence of U.S. Polar Orbiting Operational Environmental Satellite Systems, May 10, 1994," <http://www.fas.org/spp/military/docops/national/cnvrgrpf.htm> (accessed February 24, 2006).

²¹³ "The National Polar-orbiting Operational Environmental Satellite System (NPOESS)," <http://www.publicaffairs.noaa.gov/grounders/npoess.html> (accessed January 17, 2007).

²¹⁴ "The National Polar-orbiting Operational Environmental Satellite System (NPOESS)," <http://www.publicaffairs.noaa.gov/grounders/npoess.html> (accessed February 23, 2006).

Geostationary Operational Environmental Satellites

The GOES, a joint development effort of NASA and NOAA, have provided systematic, continuous observations of weather patterns since 1974. The pilot Synchronous Meteorological Satellite, SMS-A (SMS-1), launched in 1974, was the first in the series. It was followed by a second prototype, SMS-B (SMS-2), in February 1975, and an operational spacecraft, GOES-A (GOES-1), in October 1975. GOES-B (GOES-2) was successfully launched in 1977, and GOES-C (GOES-3) launched in 1978.²¹⁵ The GOES spacecraft obtained both day and night information on Earth's weather through a scanner that formed images of Earth's surface and cloud cover. The images were then transmitted to regional data-user stations for use in weather prediction and forecasting.

GOES-4 through -7, launched during the 1980s, had similar configurations. Beginning with the launch of GOES-4 in 1980 and continuing throughout the series, the instrument complement included an improved Visible/Infrared Spin Scan Radiometer (VISSR). The new VISSR, called the VISSR Atmospheric Sounder, could receive the standard operational VISSR data and also sound the atmosphere in 12 infrared bands, enabling meteorologists to acquire temperature and moisture profiles of the atmosphere.

Normally, two GOES satellites operated concurrently. GOES-East satellites were stationed at 75°W longitude, and GOES-West satellites were located at 135°W longitude. GOES-East observed North and South America and the Atlantic Ocean. GOES-West observed North America and the Pacific Ocean to the west of Hawai'i. Together, these satellites provided coverage for the central and eastern Pacific Ocean; North, Central, and South America; and the

²¹⁵ NOAA assigns a letter to the satellite before it is launched and a number once it has achieved orbit.

central and western Atlantic Ocean.²¹⁶ NASA had responsibility for designing, engineering, and procuring the satellites and launch services. Once a satellite was launched and checked out, it was turned over to NOAA for operations.

In January 1989, GOES-6, which had been launched in 1983, failed, and GOES-7, launched in 1987, became the only U.S. geosynchronous satellite tracking severe storms near the United States. From 1989 through 1991, GOES-7 covered both the Atlantic and Pacific oceans from 108°W longitude in the winter and moving in the summer and early fall to 98°W longitude to observe the formation of Atlantic hurricanes. Beginning in January 1992, in compliance with a contract signed with ESA and the European Meteorological Satellite (EUMETSAT) program, Meteosat-3 was positioned at 50°W longitude to assist in providing Atlantic coverage and permit GOES-7 to remain farther west at 112°W.²¹⁷

GOES-8 and subsequent GOES satellites were the prime observational platforms for dynamic weather and the near-Earth environment for the 1990s and beyond, providing significant improvements over the earlier spacecraft. GOES-8, launched in 1994, was the first three-axis-stabilized satellite in the series. It carried separate and independently operating Imager and Sounder instruments, allowing researchers to gather both imaging and sounding data continuously without having to alternate between the two operating modes (see figures 2-22 and 2-23). Image resolution also improved significantly. The improved resolution and dynamic range

²¹⁶ Judy Rumerman, *NASA Historical Data Book, Volume VI, 1979–1988* (Washington, DC: National Aeronautics and Space Administration Special Publication-2000-4012, 2000), pp. 38–39. Also at http://history.nasa.gov/SP-4012/vol6/vol_vi_ch_2.pdf (accessed February 27, 2006).

²¹⁷ *Aeronautics and Space Report of the President, Fiscal Year 1992 Activities*, p. 47.

of the GOES spacecraft allowed for the development of advanced image products and virtually real-time forecasting techniques.

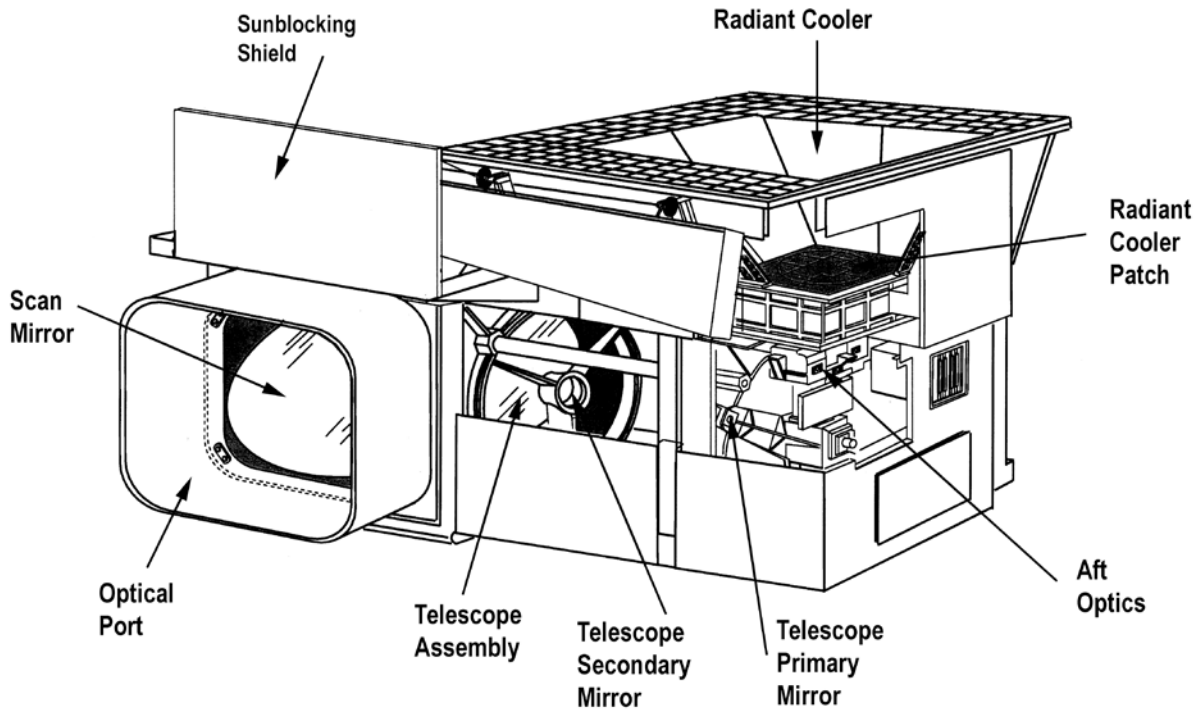

Figure 2-22. GOES Imager (NASA GOES Project).

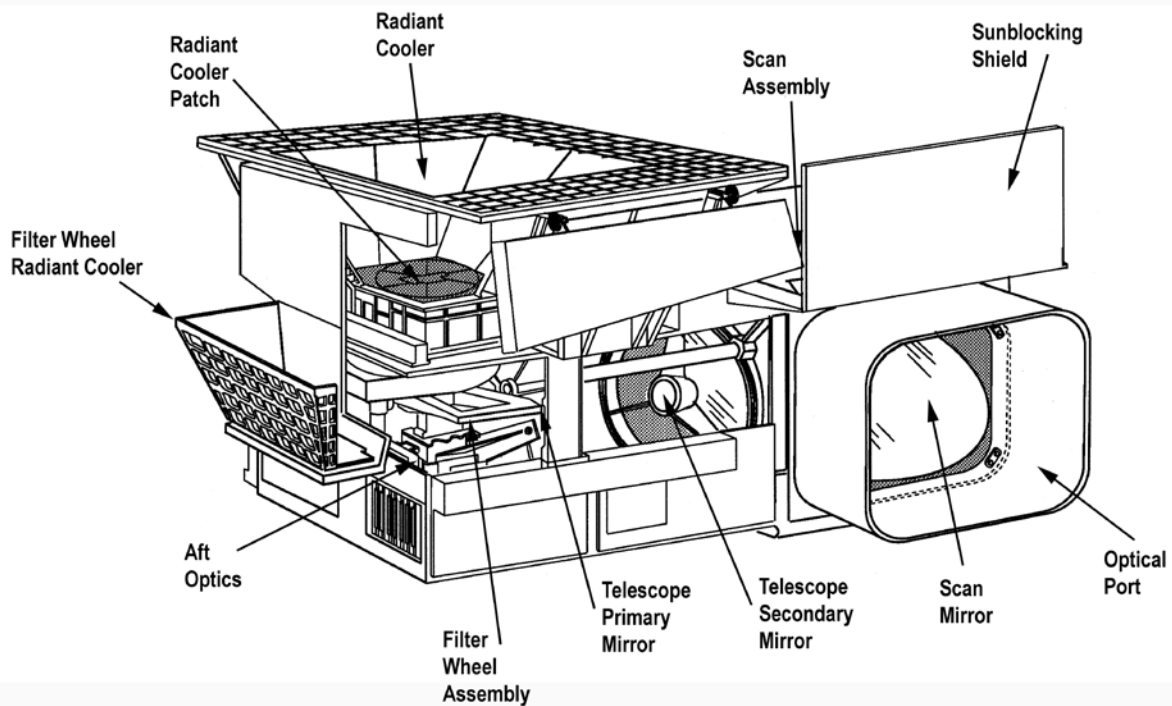

Figure 2-23. GOES Sounder (NASA GOES Project).

The spacecraft system acquired, processed, and disseminated imaging and sounding data, acquired and disseminated Space Environment Monitor (SEM) data, and received and relayed data from ground-based data collection platforms situated in selected urban and remote areas to the NOAA Command and Data Acquisition station. It also continuously relayed Weather Facsimile (WEFAX) and other data to users. The search-and-rescue system could relay distress signals from people, aircraft, and marine vessels to the search-and-rescue ground stations of the SARSAT system.

The cubic spacecraft, approximately 2 meters (6.6 feet) by 2 meters on each side, had a deployed length of 27 meters (88.6 feet). It was derived from Space System/Loral's communications

satellites.²¹⁸ GOES-9 and GOES-10, which followed in 1995 and 1997 respectively, carried the same instrument complement and had the same capabilities as GOES-8.

GOES-8 (GOES-I)

NASA successfully launched the GOES-8 satellite in April 1994. After it obtained orbit, GOES-8 was moved to its final, operational position in February 1995, and on June 8, 1995, NOAA declared it fully operational. GOES-8 provided atmospheric images, temperature and humidity profiles, wind velocity data, and severe storm coverage of Earth's Western Hemisphere. (Figure 2-24 shows cloud cover from Texas to the Atlantic Ocean.) Some GOES-8 data were made available to climate-change researchers through NASA's EOS Data Information System.

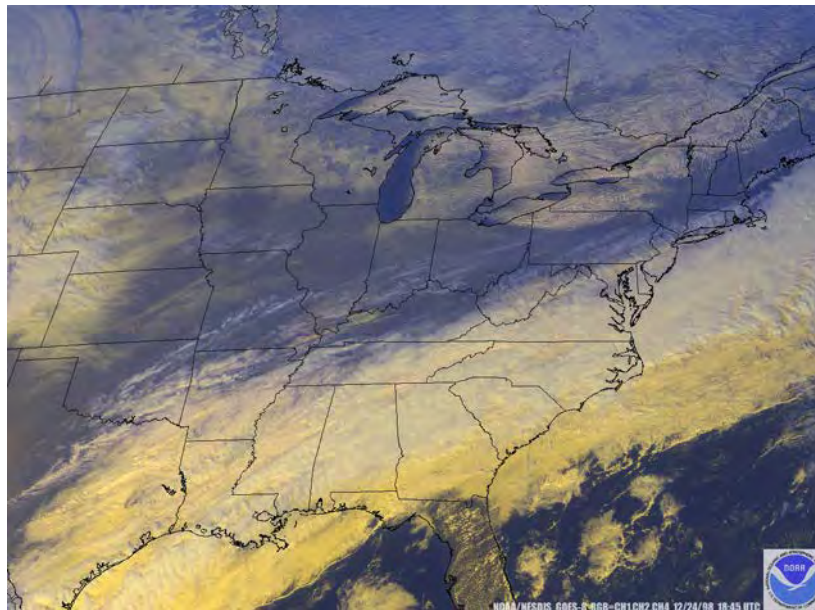

Figure 2-24. A blanket of clouds extends from southeastern Texas to the Atlantic Ocean in this GOES-8 image taken on 24 December 1998. This element brought a mixture of ice and snow to the southern Plains, the Southwest, and the Mid-Atlantic states (NOAA).

²¹⁸ "GOES-8," Destination Earth, 40+ Years of Earth Science, <http://www.earth.nasa.gov/history/goes/goes8.html> (accessed February 27, 2006).

The GOES-8 three-axis-stabilized design allowed its sensors to continuously observe Earth and thus obtain more frequent views of weather systems than the earlier spin-stabilized satellites, which viewed Earth only 5 percent of the time.²¹⁹ See table 2-83 for further mission information.

GOES-9 (GOES-J)

On May 23, 1995, NASA successfully launched GOES-9, the second advanced satellite in the GOES 8-12 series, into a geostationary orbit at 135°W. NOAA assumed control on July 21, 1995.

NOAA removed the GOES-7 satellite from operational status in January 1996 after nine years of uninterrupted service and replaced it with GOES-9 when its on-orbit satellite and instrument checkout was complete. GOES-9 joined GOES-8 in providing the United States with full weather monitoring.²²⁰ With two new-generation GOES spacecraft in orbit, images could be obtained over the continental United States and coastal waters, Hawai'i, and Alaska once every 15 minutes under normal operational modes and at approximately 7.5-minute intervals when severe weather threatened. In special cases, analysts obtained images over hurricanes at 1-minute intervals and over tornado thunderstorms every 30 seconds.²²¹ A number of small improvements were made to GOES-9 to correct problems discovered during the construction, launch, and operation of GOES-8. The Earth sensors on GOES-9 were less sensitive to sunglint and thus produced better images.²²²

²¹⁹ *Aeronautics and Space Report of the President, Fiscal Year 1995 Activities*, p. 60.

²²⁰ *Aeronautics and Space Report of the President, Fiscal Year 1995 Activities*, p. 60.

²²¹ *Aeronautics and Space Report of the President, Fiscal Year 1996 Activities*, p. 70.

²²² "GOES-9," *Destination Earth, 40+ Years of Earth Science*, <http://www.earth.nasa.gov/history/goes/goes9.html> (accessed February 27, 2006). Sunlinc is sunlight deflected back to space from the surface of a body of water.

GOES-9 was deactivated on July 28, 1998, before it met its five-year design lifetime, because of failing bearings in the momentum wheels. It was moved to a storage position.²²³ See table 2-84 for additional mission information.

GOES-10 (GOES-K)

GOES-10 was launched April 25, 1997 and placed in orbit at 105°W.²²⁴ A month after launch, the GOES-10 solar array ceased rotating; however, the GOES government-industry team inverted the satellite, modified software, and operated the solar array in the reverse direction. In the spring of 1998, GOES-10 was shut down and designated an “on-orbit spare” until GOES-8 or GOES-9 failed and the new spacecraft was needed. Soon after, GOES-9 began experiencing problems with its momentum wheels, and GOES-10 was placed in active service as GOES-West at 135°W.²²⁵ See table 2-85 for further mission information.

Oceanographic Studies

Ocean Topography Experiment (TOPEX)/Poseidon

The TOPEX/Poseidon mission was a collaboration between NASA and CNES of France. It was a core element of the World Ocean Circulation Experiment, an international study conducted in the early 1990s to improve our understanding of global climate predictions and global ocean dynamics.²²⁶ NASA provided the spacecraft bus and five instruments with their associated ground elements. CNES furnished two instruments with their associated ground elements and a

²²³ “GOES Project,” <http://goespoes.gsfc.nasa.gov/goes/timeline.html> (accessed February 27, 2006).

²²⁴ “GOES Project,” <http://goespoes.gsfc.nasa.gov/goes/timeline.html> (accessed February 27, 2006).

²²⁵ “GOES N, O, P—The Next Generation,” p. 35, http://www.osd.noaa.gov/GOES/GOES_NQBooklet.pdf (accessed February 26, 2006).

²²⁶ “TOPEX/Poseidon,” NSSDC Master Catalog, <http://nssdc.gsfc.nasa.gov/database/MasterCatalog?sc=1992-052A> (accessed February 22, 2006).

dedicated launch on an Ariane 42P rocket. Both agencies provided precision orbit determination and processed and distributed data to the science investigators.²²⁷

The mission used radar altimetry to accurately observe oceanic sea-surface topography, including sea-surface height, over 90 percent of the world's ice-free oceans. It bounced radar signals off the ocean's surface to obtain precise measurements of the distance between the satellite and the sea surface. In combination with very precise determination of the spacecraft's exact location in space, the altimetry data enabled the study and modeling of oceanic circulation and heat transport and its interaction with the atmosphere, yielding global maps of the oceans' topography to within 3 centimeters (1.2 inches) ACCURACY. From these data, scientists could determine the speeds and directions of ocean currents worldwide, thus gaining a greater understanding of Earth's climate. The data from this mission, along with ship and aircraft research, produced complex computer models of global climate. TOPEX/Poseidon measurements were supplemented by data from other spacecraft, such as the European Remote Sensing Satellite (launched in 1991), the Japanese ADEOS, and NASA's EOS platforms.²²⁸ Every 10 days, scientists could produce a complete map of global ocean topography--the barely perceptible hills and valleys found on the sea surface.²²⁹ Figure 2-25 shows a map of the Pacific Ocean produced using TOPEX/Poseidon measurements.

²²⁷ "TOPEX/Poseidon," http://ilrs.gsfc.nasa.gov/satellite_missions/list_of_satellites/topex/index.html (accessed January 12, 2006).

²²⁸ *Aeronautics and Space Report of the President, Fiscal Year 1992 Activities*, p. 46.

²²⁹ "TOPEX/Poseidon Helps Marine Biologists Study Whales," *NASA News Release 96-209*, October 15, 1996.

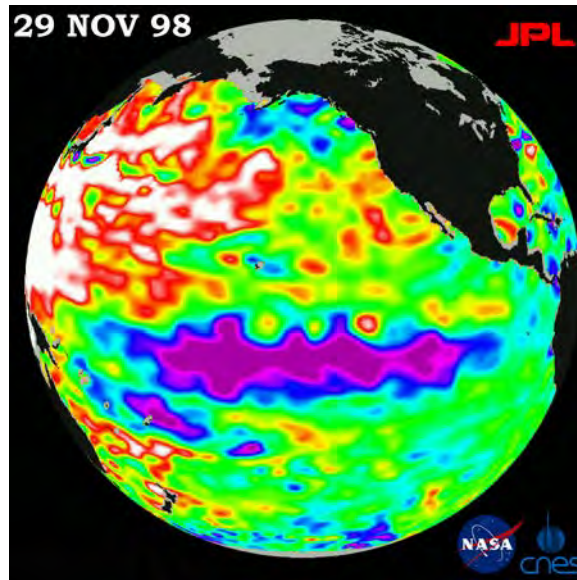

Figure 2-25. This image of the Pacific Ocean was produced using sea-surface height measurements taken by the TOPEX/Poseidon satellite. It shows sea-surface height relative to normal ocean conditions on 29 November 1998, indicative of the changing amount of heat stored in the ocean. The image shows that an unusual large-scale warming (shown in red and white) of the western Pacific, first observed in early November, has spread to the central Pacific. The low sea level or cold pool of water (commonly referred to as La Niña), shown in purple, has remained essentially the same, changing very little in size and heat content (NASA-JPL photo PIA01498).

TOPEX/Poseidon was a precursor to the EOS altimetry instruments and flew as part of NASA's MTPE. NASA's Jet Propulsion Laboratory began planning the TOPEX mission in 1979. At the same time, CNES was designing an oceanographic mission called Poseidon. The two space agencies decided to cooperate and pool their resources to form a single mission.²³⁰ The project's Critical Design Review was successfully conducted in May 1989. Hardware fabrication of the satellite system and instruments took place in 1989 and 1990, and delivery occurred in 1991. The spacecraft was launched from the European Space Center in Kourou, French Guiana, on an Ariane 42P ELV in August 1992.

²³⁰ "Missions—TOPEX/Poseidon Launch," <http://topex-www.jpl.nasa.gov/mission/tp-launch.html> (accessed January 12, 2006).

Measurements obtained by TOPEX/Poseidon provided the most accurate data yet available on global sea level changes, constituting the first map of ocean topography. Oceanographers used it to calibrate computer models to help forecast changes in climate. Using data from TOPEX/Poseidon in early 1993, scientists confirmed that conditions were ripe for development of an El Niño event in the eastern equatorial Pacific Ocean.²³¹ Observations a few months later showing high sea-surface elevation, which reflected an excessive amount of unusually warm water in the upper ocean, confirmed that El Niño had returned and was getting stronger.²³² Investigators analyzed a prominent “Kelvin wave” moving toward the western coast of South America in the TOPEX/Poseidon altimeter data. This large, warm-water mass moving along the equator typically given rise to an El Niño event that dramatically affects fish harvests in the eastern equatorial Pacific and is believed to be responsible for meteorological events, including significant rainfall and temperature variations, across the United States. The seasonal change in sea level observed by TOPEX/Poseidon was about 50 percent greater in the Northern Hemisphere than in the Southern Hemisphere. This previously unknown asymmetry indicated that the air–sea heat exchange was much stronger in the Northern Hemisphere than in the southern half of the globe. Satellite data also enabled scientists to track disturbances caused by the lingering effects of the 1991–1993 El Niño event, the longest in 40 years. Observations made by TOPEX/Poseidon in the North Pacific revealed a northward shift of the Kuroshio, the swift current southeast of Japan, that was traced back to the El Niño event of 1982–1983. Meteorologists believed that the position of the Kuroshio dramatically affected the weather of North America.²³³

²³¹ “TOPEX/Poseidon Data Confirms El Niño Predictions,” *NASA News Release* 93-205, November 9, 1993.

²³² “TOPEX/Poseidon Confirms El Niño Is Back and Stronger than in 1993,” *NASA News Release* 95-7, 24 January 1995.

²³³ *Aeronautics and Space Report of the President, Fiscal Year 1994 Activities*, p. 58.

TOPEX/Poseidon challenged a fundamental oceanographic theory about the speed of large ocean waves, called “Rossby waves.” These waves, which span hundreds of miles from one wave crest to the next, can alter currents and their corresponding sea-surface temperatures, thereby influencing how oceans release heat to the atmosphere and thus affect weather patterns. More precise information about the speed in which these waves travel may help forecasters improve their ability to predict the effects of El Niño events on weather patterns years in advance. Using satellite data, scientists determined that the Rossby waves were moving two to three times faster than previously thought.²³⁴

In August 1995, TOPEX/Poseidon successfully completed its three-year primary mission, providing oceanographers with their first global dataset on Earth’s oceans, and began its extended mission, which ended in January 2006. The extended mission dealt with questions about long-term variations in the ocean and understanding the role oceans play in long-term global change.²³⁵

In 1996, NASA agreed to undertake a follow-on mission to TOPEX/Poseidon. The follow-on altimetry radar mission, called Jason-1, was initially scheduled for launch in 1999.²³⁶ France would provide the spacecraft and altimeter while NASA would provide the radiometer, ground system, and launch.

Among the achievements of TOPEX/Poseidon was its determination of the patterns of ocean circulation, i.e., how heat stored in the ocean moves from one place to another. Since the ocean

²³⁴ *Aeronautics and Space Report of the President, Fiscal Year 1996 Activities*, p. 71.

²³⁵ “TOPEX/Poseidon Completes Prime Mission,” *NASA News Release 95-146*, August 29, 1995.

²³⁶ Jason-1 launched on December 7, 2001.

holds most of Earth's heat from the Sun, ocean circulation is a driving force of climate. Another mission accomplishment was the first mapping of global tides. The mission also was the first to demonstrate that the Global Positioning System could be used to determine a spacecraft's exact location and track it in orbit. Knowing a satellite's precise position (to within 2 centimeters or less than 1 inch] in altitude) was key to making accurate ocean height measurements.²³⁷

The TOPEX/Poseidon spacecraft consisted of the multimission modular spacecraft (MMS) and the instrument module housing the sensors. The MMS was based on the existing MMS bus flown on the French/CNES SPOT 2 spacecraft, Landsats 4 and 5, the Solar Maximum Mission spacecraft, UARS, and the Extreme Ultraviolet Explorer.²³⁸ It included 1) the command and data-handling subsystem containing the main on-board computer; 2) the attitude-determination and -control subsystem for maintaining the spacecraft's attitude, and 3) the electrical-power subsystem containing the solar array and three batteries. The command and data handling subsystem housed three tape recorders for collecting engineering telemetry and instrument data. This subsystem also provided telecommunications using a steerable high-gain antenna dish and two omni antennas. During normal operations, the satellite communicated with the Tracking and Data Relay Satellite System (TDRSS). The 8.7-meter by 3.3-meter (28.5-foot by 10.8-foot) solar array was deployed about two minutes after the satellite separated from the Ariane launch vehicle. The batteries provided power before deployment of the solar array and during the nighttime part of the orbit.²³⁹ Figure 2-26 shows the spacecraft components.

²³⁷ "TOPEX/Poseidon: Sails Off into the Sunset," January 2006, Newsroom—Features, <http://sealevel.jpl.nasa.gov/newsroom/features/200601-1.html> (accessed February 20, 2006).

²³⁸ "TOPEX/Poseidon Spacecraft Features Fairchild's Modular Design," Fairchild News Release, NASA History Division folder 006502, Historical Reference Collection, NASA Headquarters, Washington, DC.

²³⁹ "Topex/Poseidon," NSSDC Master Catalog, <http://nssdc.gsfc.nasa.gov/database/MasterCatalog?sc=1992-052A> (accessed February 22, 2006).

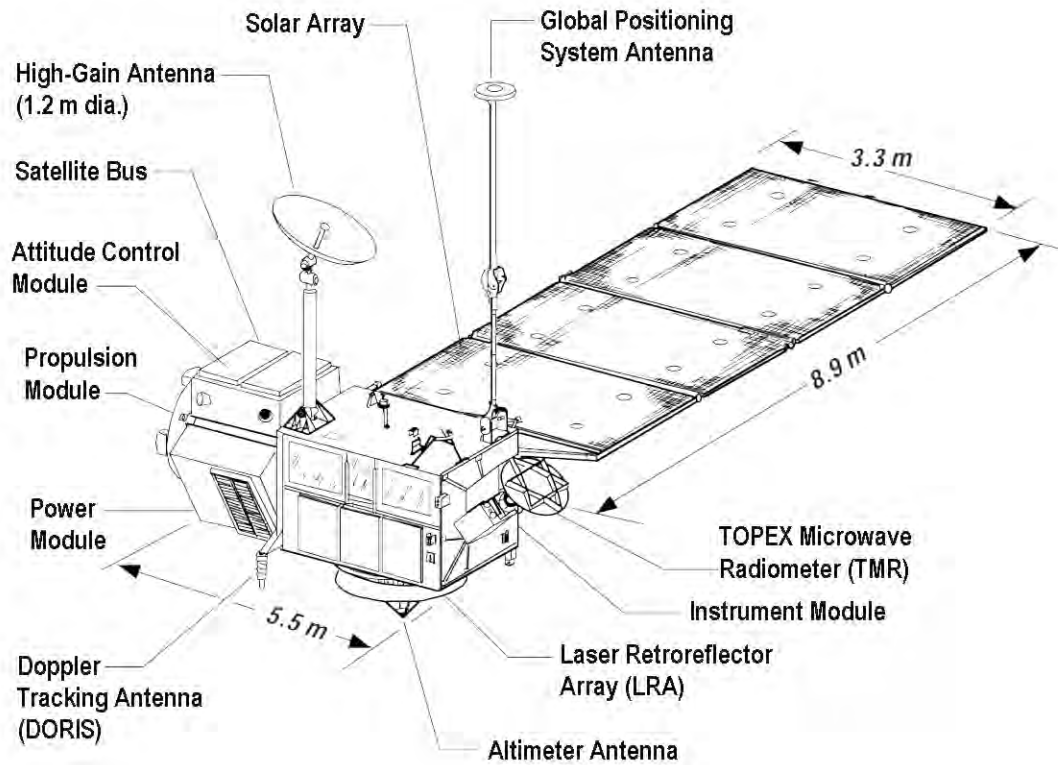

Figure 2-26. TOPEX spacecraft (NASA/JPL-Caltech).

In August 1994, CNES honored members of the U.S.–French TOPEX/Poseidon management team from NASA Headquarters, JPL, and the CNES Project Office by awarding them the CNES Medal in recognition of their achievements.²⁴⁰

See table 2-86 for further mission information. Table 2-87 lists mission investigations.

²⁴⁰ “French Space Agency Honors TOPEX-Poseidon Team,” *NASA News Release 94-132*, August 10, 1994.

NASA Scatterometer and Quick Scatterometer

The NASA Scatterometer (NSCAT), an active microwave satellite scatterometer, flew on the Japanese ADEOS spacecraft from September 1996 until the ADEOS spacecraft was lost in June 1997.²⁴¹ It shared the spacecraft with NASA's TOMS, one French instrument, and several Japanese instruments. NSCAT was developed by JPL as part of the Earth Probe program of MTPE.

The NSCAT program was first initiated in October 1984, and the mission was a key contributor to international ocean research. The Scatterometer was initially planned to launch aboard the Navy Remote Sensing Satellite (N-ROSS), but when N-ROSS was canceled in 1988, NASA proposed to the National Space Development Agency of Japan (NASDA) that NSCAT fly as a payload on ADEOS as a follow-on to the Seasat-1 Scatterometer (SASS), flown in 1978. NSCAT was selected in August 1989 to fly on ADEOS.²⁴²

Launched on August 16, 1996 on ADEOS, NSCAT was a precursor to the scatterometry elements of NASA's EOS program. It measured the ocean surface wind velocity and provided data on air-sea interactions, calculations for large-scale fluxes between atmosphere and ocean, air-sea coupling, and interannual variability of Earth's climate.

²⁴¹ Scatterometry is a form of radar remote sensing that can measure various geophysical properties of surfaces and volumes based on the amplitude of microwave electromagnetic pulses transmitted from and scattered back to an antenna aboard the spacecraft. It is called a scatterometer because it measures these backscattered pulses. "What Is Scatterometry?" http://cires.colorado.edu/~maurerj/scatterometry/what_is_scatterometry.htm (accessed February 5, 2007).

²⁴² Office of the Federal Coordinator for Meteorology, "Weather Programs of Other Agencies," Appendix D in *The Federal Plan for Meteorological Services and Supporting Research, Fiscal Year 1997*, <http://www.ofcm.gov/fp-fy97/text/app-d.htm> (accessed March 2, 2006).

Every two days, under all weather and cloud conditions, NSCAT, flying in a near polar Sun-synchronous orbit, measured wind speeds and directions over at least 90 percent of Earth's ice-free oceans. Since oceans cover approximately 70 percent of Earth's surface, NSCAT played a key role in scientists' efforts to understand and predict complex global weather patterns and climate systems. Its systematic, high-resolution observations of wind over the oceans were critical for understanding the processes by which the oceans and atmosphere help moderate Earth's climate.²⁴³ They were also valuable for understanding the interaction between the atmosphere and oceans and improving the prediction and tracking of severe storms.²⁴⁴ The NSCAT dataset has been used by climate-change researchers, operational weather forecasters, and commercial ship routing firms. Figure 2-27 shows a synoptic view of ocean surface wind produced by NSCAT measurements.

²⁴³ "New Wind Data Improving Accuracy of Weather Forecasts," *NASA News Release 97-32*, March 4, 1997.

²⁴⁴ *Aeronautics and Space Report of the President, Fiscal Year 1996 Activities*, p. 71.

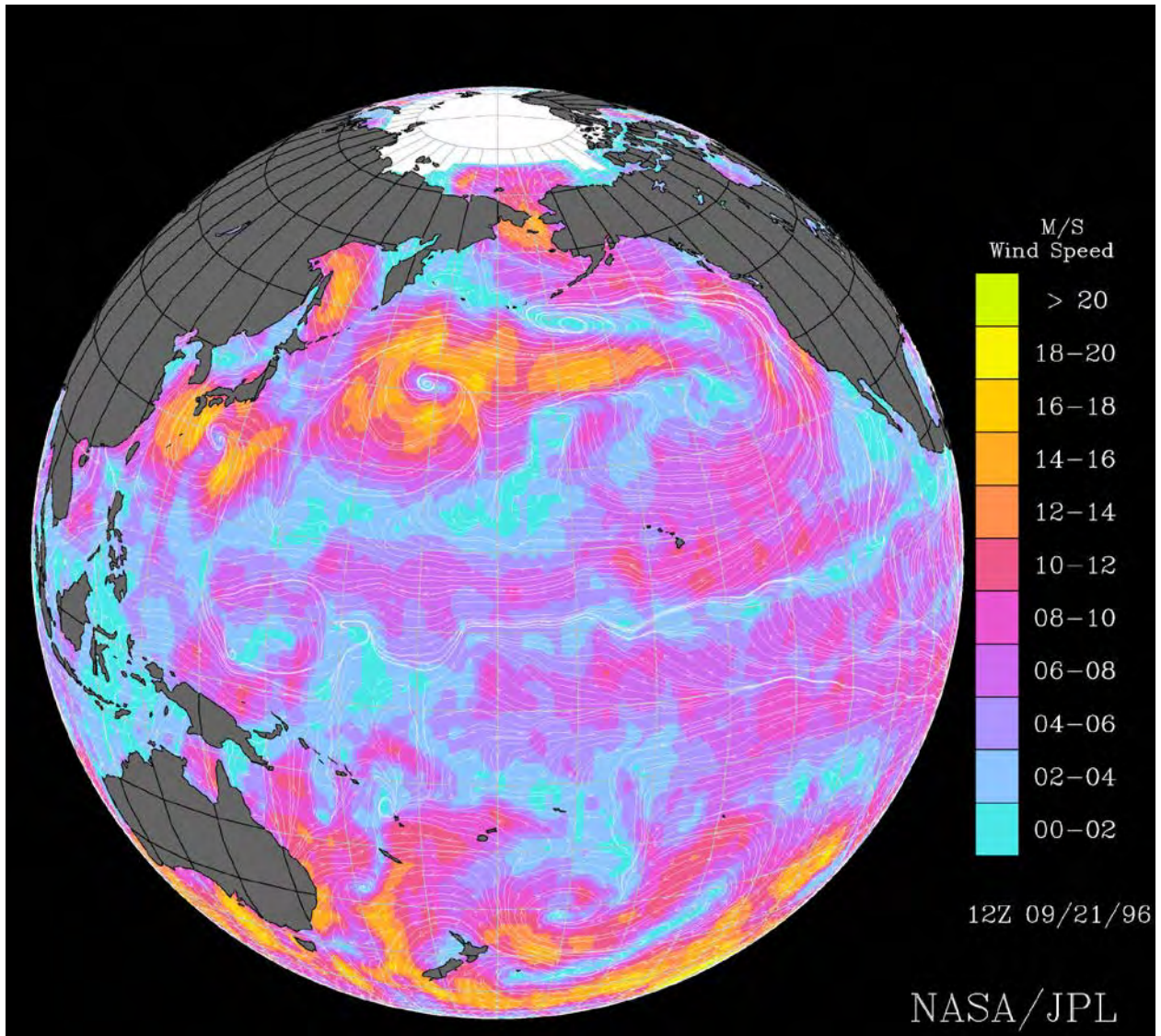

Figure 2-27. This image shows ocean surface wind speeds and directions over the Pacific Ocean on 21 September 1996, as measured by the NASA Scatterometer onboard Japan's ADEOS. The background color indicates wind speed and the white arrows show the direction of the wind. Two typhoons are observed in the western Pacific. Typhoon Violet is just south of Japan. After this image was taken, Typhoon Violet struck the east coast of Japan, causing damage and deaths. Typhoon Tom is located farther east and did not land (NASA-JPL photo p47490).

NSCAT transmitted continuous pulses to the ocean surface and received backscattered radiation from Earth. The radar cross section of the surface was used to derive the backscattered radiation as a function of both wind speed and direction and to determine the wind vector. NSCAT was the

first spaceborne scatterometer to use on-board digital processing of a Doppler-shifted signal. NSCAT data were processed into science products directly from telemetry by the NSCAT Data Processing and Instrument Operations (DP&IO) on the ground.²⁴⁵

The satellite consisted of three major subsystems: the Radio Frequency Subsystem (RFS), the Antenna Subsystem, and the Digital Data Subsystem (DDS). The RFS generated pulses at 13.995 gigahertz (Ku-band) to each antenna beam. A low-noise amplifier of 3 dB amplified the return echo. The antenna subsystem consisted of an array of six stick-like, dual-polarization, fan-beam antennas, each approximately 10 feet (3 meters) long and calibrated to 0.25 dB before launch, that radiated microwave pulses in the Ku-band across broad regions of Earth's surface. A small fraction of the energy in the radar pulses was reflected back and captured by the antennas. NSCAT's antennas scanned two swaths of ocean—one on either side of the satellite's near-polar, Sun-synchronous 500-mile (805-kilometer) orbit—for backscattered power. The swaths were each about 375 miles (603.5 kilometers) wide at nadir, and a gap of about 215 miles (347 kilometers) directly below the satellite separated the swaths. No data collection was possible in the gap.²⁴⁶ Changes in small (centimeter-sized), wind-driven waves caused variations in the magnitude of backscattered power. Using Doppler processing, the measured backscattered power was separated into cells at specific locations on Earth's surface, and the data were then transmitted to the ground for processing. During ground processing, wind direction and speed were determined from the variations. Within two weeks of receiving the raw data, the ground system processed the wind measurements.²⁴⁷

²⁴⁵ "NASA Scatterometer," NSSDC Master Catalog, <http://nssdc.gsfc.nasa.gov/database/MasterCatalog?sc=1996-046A&ex=3> (accessed March 2, 2006).

²⁴⁶ "New Wind Data Improving Accuracy of Weather Forecasts," NASA News Release: 97-32, March 4, 1997, <http://www.gsfc.nasa.gov/news-release/releases/1997/97-32.htm> (accessed March 2, 2006).

²⁴⁷ "Missions—NSCAT," Winds—Measuring Ocean Winds from Space," <http://winds.jpl.nasa.gov/missions/nscat/index.cfm> (accessed March 2, 2006).

From September 1996 to June 1997, NSCAT gathered 40 weeks' worth of data before ADEOS was lost. To replace the valuable data gathered from NSCAT, in November 1997, NASA approved an immediate "new start" for the Quick Scatterometer (QuikSCAT) mission and placed the first rapid spacecraft delivery order to Ball Aerospace for the satellite core systems. The mission was a unique collaboration between JPL and Goddard. JPL's SCAT/Sea Winds Program Office had management responsibility and provided ground systems and a scatterometer instrument. GSFC was responsible for procuring the satellite under the newly instituted "indefinite delivery/indefinite quantity (IDIQ)" system, which enabled THE quick acquisition.²⁴⁸ The SeaWinds instrument, developed by JPL, was delivered to Ball Aerospace for integration into the satellite in June 1998. The instrument used specialized microwave radar that measured both the speed and direction of winds near the ocean surface.²⁴⁹ QuikSCAT was launched from Vandenberg Air Force Base atop a Titan II launch vehicle on June 19, 1999, into a near-polar orbit. Table 2-88 lists NSCAT mission characteristics.

Communications Program

During the decade from 1989 through 1998, NASA participated in only two communications programs: the Advanced Communications Technology Satellite (ACTS) and the international SARSAT program.

²⁴⁸ "NASA Awards the First Rapid Spacecraft Delivery Order to Ball Aerospace for the Delivery of QuikScat Spacecraft, JPL Public Information Office, November 19, 1997, <http://www.jpl.nasa.gov/releases/97/quikscat.html> (accessed February 12, 2007).

²⁴⁹ "SeaWinds Instrument Shipped for Integration on QuikSCAT," JPL Media Relations Office, June 9, 1998, <http://www.jpl.nasa.gov/releases/98/quikship.html> (accessed February 12, 2007).

Advanced Communications Technology Satellite

The ACTS program was a NASA program that developed and flight-tested high-risk, advanced communications satellite technology for use in multiple-frequency bands and applicable to a wide range of future communications systems. These advanced communications technologies, intended for use by the private sector, were validated through the ACTS experiments program.²⁵⁰

The flight validation of the technologies allowed industry to adapt them to individual commercial requirements with minimal risk.²⁵¹ The demonstrated technologies were expected to promote the creation of new telecommunications services, thereby improving the nation's economy and enhancing U.S. competitiveness in the global telecommunications market.

Until 1973, NASA had been involved in developing communications-satellite technology, and launching and operating communications satellites. That year, NASA sharply curtailed its satellite-communications program due to budget pressures and the belief that private industry could develop the technology that NASA had initially sponsored. In 1974, several organizations began to assess the consequences of this decision. In 1975, NASA asked the National Research Council to consider whether the federal government should resume research and development in the field of satellite communications, and, if so, what its role should be. The Council concluded that "communication satellite technology required government investment, particularly where high technical risks were involved."²⁵² Based on this report, increased demand, and foreign competition, President Jimmy Carter reinstated federal sponsorship of communications-satellite

²⁵⁰ Richard T. Gedney, Ronald Schertler, Frank Gargione, *The Advanced Communications Technology Satellite: An Insider's Account of the Emergence of Interactive Broadband Technology in Space* (Mendham, NJ: SciTech Publishing, Inc., 2000), p. xi.

²⁵¹ "Advanced Communications Technology Satellite (ACTS)," <http://acts.grc.nasa.gov/> (accessed January 12, 2006). Also "Survey of Advanced Applications Over ACTS," http://acts.grc.nasa.gov/docs/ACTS_2000_31.pdf (accessed February 16, 2006).

²⁵² Gedney, pp. 6–11.

technology. In October 1978, he issued Presidential Directive PD-42, stating: “NASA will undertake carefully selected communication technology R&D. The emphasis will be to provide better frequency and orbit utilization approaches.” As a result, NASA returned to communications-satellite research and development.

In 1979, NASA chose Lewis Research Center to lead the planning and execution of a commercial communications-satellite technology R&D program. The Agency conducted market studies that confirmed the need for increased capabilities and performed proof-of-concept development of identified technologies.

During the 1980s, the program was threatened with cancellation as the Reagan administration and others argued that the federal government should not work to test and prove technology for a profitable commercial industry. Nevertheless, largely because of concerns about U.S. economic competitiveness, Congress kept the program alive. In May 1984, in spite of administration objections and after it had reduced funding to a level too small to sustain a flight program, Congress approved a \$40 million increase for ACTS, clearing the way for a contract with RCA for the ACTS flight system. Other members of the contract team were also chosen. TRW was the selected subcontractor for the communications payload, and COMSAT given responsibility for the NASA ground station and master control station.²⁵³

Each year through 1988, the Administration continued its attempts to end the program by deleting all funds for ACTS from the budget while Congress kept reinstating them, though

²⁵³ Gedney, p. 184.

usually at a level lower than originally requested.²⁵⁴ This decreased funding resulted in extending the time needed for development, and ultimately led to higher total costs even though changes in technical scope cut more than \$25 million from the cost. Through the first two years of operations, program costs grew from \$329 million, as stated at the time of contract award, to \$481 million due largely to funding constraints that lengthened development time and led to cost overruns. Most cost overruns occurred during 1986 and 1987 as a result of TRW's communications-payload subcontract.²⁵⁵ In January 1988, Congress agreed to a cost cap of \$499 million. TRW was dropped from the contract team, and the program was restructured so that NASA's Lewis Research Center became the integrating contractor. GE Astro (formerly RCA) used its second-tier subcontractors to complete the payload. In January 1989, OMB deleted funds for ACTS once more in the administration's FY 1990 budget request to Congress, but Congress again reinstated them. This was the last time the OMB attempted to cancel the program.²⁵⁶

Launch had initially been planned for September 1989. However, funding cutbacks, development difficulties, and other problems delayed the launch until September 12, 1993, when NASA successfully launched ACTS from the Space Shuttle on STS-51 into geosynchronous orbit by means of a transfer orbit stage component. The satellite achieved geostationary orbit at 100°W longitude on September 28, 1993.²⁵⁷

ACTS was the first high-speed, all-digital communications satellite. Once in orbit, it operated in the Ka-band (18–30 gigahertz) portion of the radio spectrum. ACTS technology integrated well

²⁵⁴ Gedney, pp 19–24.

²⁵⁵ Gedney, pp. 186–189.

²⁵⁶ Gedney, pp. 190–191.

²⁵⁷ Gedney, p. 29.

with ground telephone network systems, allowing for high-speed transmission over great distances to even the most remote locations.²⁵⁸

A major component of the program was the ACTS Experiments Program, which had begun in 1979—years before the ACTS launch. A carrier working group from various industry organizations helped NASA formulate the technology, flight system, and user-trial requirements, and provided overall guidance and advice. In June 1980, NASA issued the Experiments Planning document containing a list of 73 potential experiments submitted by NASA and the working group. In March 1983, NASA issued a formal Notice of Intent for Experiments that solicited expressions of intent to conduct experiments or user trials. Eighty-five organizations responded, and 122 experiments and user trials were proposed. Widespread publicity beginning in 1984 made potential users aware of ACTS's capabilities. Annual experiment conferences provided details of the spacecraft and ground terminal development and updates of the Experiments Program. An Industry Advisory Group, formed by NASA in December in 1988, advised NASA on the Experiments Program plan, the process and criteria for selecting experiments, ways to foster the telecommunication community's involvement, approaches to providing experimental Earth stations, and the types of experiments and demonstrations to be performed.²⁵⁹ In August 1991, NASA issued an Experiment Opportunity Announcement soliciting proposals for investigations to test and evaluate key technologies of the ACTS flight and ground systems and various applications services. Initially, 40 investigations were selected.

²⁵⁸ "Switchboard in the Sky: The Advanced Communications Technology Satellite (ACTS)," NASA Facts, FS-2002-06-013-GRC, June 2002, <http://www.nasa.gov/centers/glenn/about/fs13grc.html> (accessed February 16, 2006).

²⁵⁹ Gedney, pp. 108–109.

Satellite operations and the ACTS Experiments Program began on December 6, 1993, following completion of all spacecraft, ground-system, and network on-orbit checkouts.²⁶⁰ The program had an initial duration of two years. During this period, participants from industry, academia, and government investigated applications in medical imagery, long-distance education, business and supercomputing networking, high-definition television, and many other areas. An extensive network of ground stations supported the satellite. These stations operated in the Ka-band frequency and offered unique features that distinguished them from other current satellite-communications ground stations.²⁶¹ With the success of the program and a fully functional payload, the program was extended two more years. At the end of four years, experimenter interest and unresolved issues involving broadband satellite/terrestrial network protocol interoperability warranted further extension of the program. In August 1998, the spacecraft's operations were altered to allow the system to drift on orbit in the north/south attitude so that extended operations could be carried out with the little remaining on-board fuel. New goals were also defined for the Experiments Program, providing a more focused program that emphasized support of the goals of NASA's four strategic enterprises. These latest goals were to use ACTS as a testbed to 1) demonstrate NASA's and other government agencies' transition to commercial systems; 2) test and evaluate communications protocols for their interoperability with terrestrial systems; 3) evaluate narrow spot beam, Ka-band satellite operations in an inclined orbit; and 4) verify Ka-band satellite technologies.²⁶² The Experiments Program ended May 31, 2000.²⁶³

²⁶⁰ Gedney, p. 112.

²⁶¹ *Aeronautics and Space Report of the President, Fiscal Year 1993 Activities*, pp. 32–33.

²⁶² "Survey of Advanced Applications Over ACTS," http://acts.grc.nasa.gov/docs/ACTS_2000_31.pdf (accessed February 16, 2006).

²⁶³ "For ACTS Experiments—All Good Things Must Come to an End," Glenn Research Center Release 00-032, May 30, 2000, <http://www.nasa.gov/centers/glenn/news/pressrel/2000/00-032.html> (accessed March 15, 2006).

From 1993 through March 2000, 104 experiments were initiated (59 during the years 1994–1995, and 45 in 1996–2000). The 104 experiments were proposed by 61 unique PI organizations from government (26 percent), industry (43 percent), and academia (31 percent). The experiments fell into the general areas of technology verification, propagation, and applications.²⁶⁴ Examples include:

- Telemedicine: ACTS transmitted data-intensive imagery linking urban medical specialists to underserved areas of the United States
- Electric utility companies: ACTS controlled power grids by using ultra-small terminals to poll the grid in remote areas, demonstrating potential cost savings
- Distance learning: ACTS improved high-quality interactive video and audio for delivery of advanced-degree, continuing, and remedial training to people in remote locations
- Business: ACTS used its high-speed links with major computers to integrate design teams using remote research equipment to explore natural resources. This process increased the possibility of saving millions of dollars in annual costs
- Personal and airborne mobile communications services: ACTS demonstrated various practical technologies, such as enabling advanced communications services for passengers on board the U.S. commercial aircraft²⁶⁵

Table 2-89 lists the experiments.

²⁶⁴ “Survey of Advanced Applications Over ACTS,” http://acts.grc.nasa.gov/docs/ACTS_2000_31.pdf (accessed February 16, 2006).

²⁶⁵ “For ACTS Experiments—All Good Things Must Come to an End,” Glenn Research Center Release 00-32, 30 May 2000, <http://acts.grc.nasa.gov/docs/actscg28.PDF> (accessed February 5, 2007).

The ACTS system consisted of a spacecraft and a ground segment. The ACTS multi-beam antenna consisted of separate Ka-band receive and transmit antennas. The main receiving antenna was 7.2 feet (2.2 meters) in diameter, and the main transmit antenna was 10.8 feet (3.3 meters) in diameter. ACTS also incorporated beacons at 20.2 and 27.5 gigahertz.²⁶⁶ Figure 2-28 shows the spacecraft's on-orbit configuration.

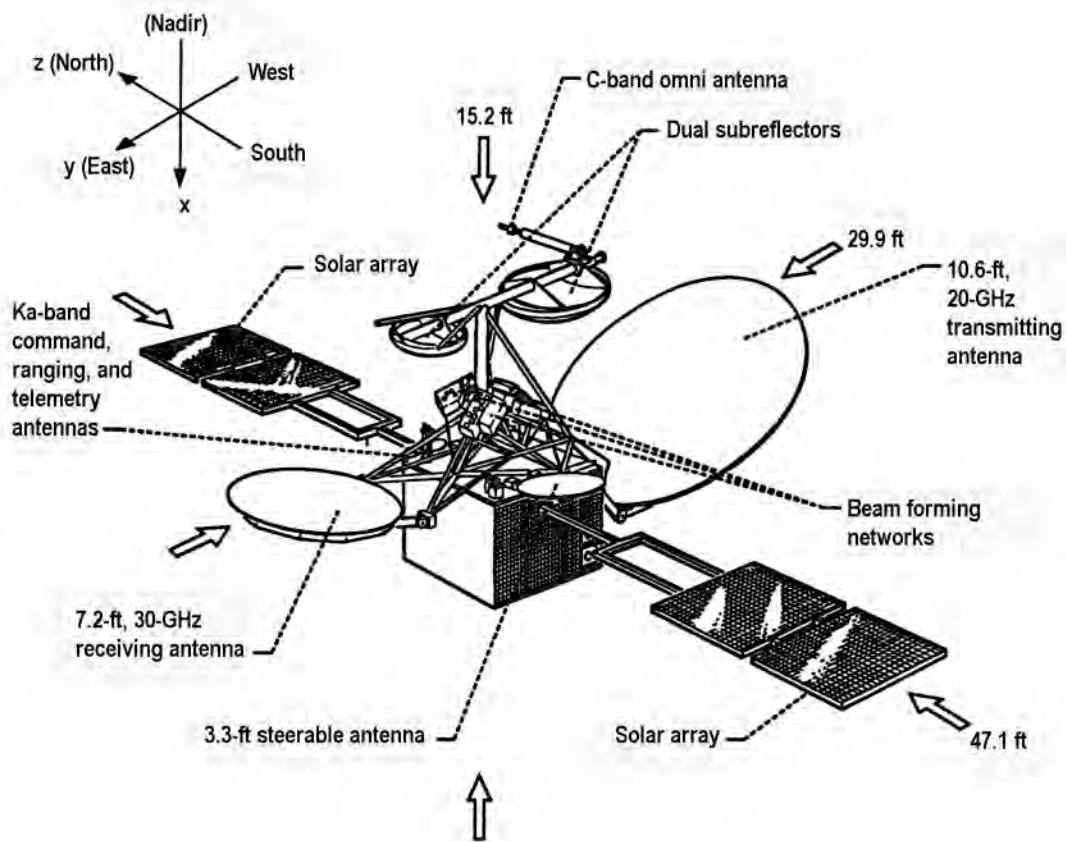

Figure 2-28. ACTS on-orbit configuration showing overall dimensions (STS-51 Press Kit).

ACTS's multi-beam communications payload encompassed several key technologies that supported a full range of on-demand voice, video, and data communications services. Key ACTS technologies included:

²⁶⁶ Advanced Communications Technology Satellite, Technology, Spacecraft," <http://acts.grc.nasa.gov/technology/spacecraft/index.shtml> (accessed February 16, 2006).

- *Ka-band Spectrum*: Operation in the Ka-band radio spectrum (30/20 gigahertz), where 2.5 gigahertz of spectrum were available for use (five times that available in lower frequency bands).
- *Multiple Hopping-Beam Antennas*: Multiple high-gain, hopping-beam antenna systems that permitted the use of smaller dish Earth terminals.
- *On-Board Digital Processing and Switching*: On-board baseband processing and switching (BBP), which interconnected users at different Earth station locations at an individual circuit level.
- *Microwave Switch Matrix (MSM)*: The MSM enabled high-speed (gigabits per second) communications and data transfer between users.
- *Adaptive Rainfade Compensation*: The effects of rain on the satellite signal (rain fades) were automatically compensated for on uplink and downlink transfers of information. The effects of rain remained transparent to the end-user.²⁶⁷

A NASA ground station and master control station at Lewis Research Center transmitted commands to the satellite, received all spacecraft telemetry, performed ranging operations, and provided network control for all user communications. A satellite operations center was located at Lockheed Martin Astro Space in East Windsor, New Jersey, and connected to the ground station and control station by means of landlines. In June 1998, the Satellite Operations Center (SOC) was transferred to the Lockheed Martin Communications and Power Center facility in Newtown, Pennsylvania.²⁶⁸ The satellite was developed by GE Astro Space for NASA. It was first operated by GE Astro Space, then by Martin Marietta Astro Space, and finally by Lockheed

²⁶⁷ Advanced Communications Technology Satellite, Technology, Spacecraft,” <http://acts.grc.nasa.gov/technology/spacecraft/index.shtml> (accessed February 16, 2006).

²⁶⁸ Gedney, pp. 29–31.

Martin after Martin Marietta and Lockheed merged.²⁶⁹ See table 2-90 for further mission information.

Search and Rescue

NASA's search-and-rescue program was part of the Cospas-Sarsat (Cosmicheskaya Sistyema Poiska Avariynich Sudov [Space System for the Search of Vessels in Distress]/Search and Rescue Satellite-Aided Tracking) system, an international satellite-based search-and-rescue system that located distress beacons from endangered people, maritime vessels, and aircraft. The program was a joint venture of the United States, the Soviet Union, Canada, and France. U.S. participants included NASA, NOAA, the U.S. Coast Guard, and the Air Force.

In the Cospas-Sarsat system, a person on the ground with a PLB or on the water with an EPIRB transmitted a distress signal to a satellite overhead carrying SARSAT equipment. Distressed planes transmitted a signal using the emergency locator transmitter. The satellite relayed the message to a local user terminal (LUT) on the ground, which then relayed the message to a mission control center (MCC) in the country operating the LUT. Routed alerts included beacon location computed at the LUT if the alert was received by one of the system's LEO satellites. Data received by system satellites in geosynchronous orbit provided instantaneous alerts and could include location information if the beacon was a self-locating type. The MCC alerted the Rescue Coordination Center (RCC), which radioed a search-and-rescue unit to look for the missing or distressed persons or vehicles. The U.S. RCCs were operated by the Coast Guard and the Air Force.²⁷⁰

²⁶⁹ Donald H. Martin, *Communication Satellites*, Fourth Edition (El Segundo, CA: Aerospace Press, American Institute of Aeronautics and Astronautics, Inc., 2000), p. 49.

²⁷⁰ "Cospas-Sarsat System Operations," http://searchandrescue.gsfc.nasa.gov/cospas_sarsat/system_overview.html (accessed May 23, 2007).

The instruments on satellites carrying Cospas-Sarsat equipment could receive 121.5-, 243-, and 406-MHz distress signals. Signals sent on the 121.5- or 243-MHz frequencies allowed locations to be determined within 20 kilometers (12.4 miles) of the transmission site. These signals were received by the SARR and transmitted in real time over 1,544.5 MHz to the LUT on the ground. With four operational satellites in orbit (NOAA and Soviet satellites), the time until contact between an individual in an emergency situation and a satellite varied from a few minutes to a few hours. Figure 2-29 shows the search-and-rescue system.



Figure 2-29. Search-and-rescue system (GSFC).

The use of meteorological satellites for search-and-rescue operations was first envisioned in the late 1950s. NASA began to experiment with random-access Doppler tracking on the Nimbus

satellites in the 1970s. The Cospas-Sarsat program became an international effort in 1976, with the United States, Canada, and France discussing the possibility of satellite-aided search-and-rescue. This satellite system was initially developed under an MOU among agencies of the USSR, the United States, Canada, and France that was signed in 1979. Following successful completion of the demonstration and evaluation phase that began in September 1982, a second MOU was signed on October 5, 1984, by the CNES of France, the Department of National Defence (DND) of Canada, the Ministry of Merchant Marine (MORFLOT) of the USSR, and NOAA. The system, which then used LEO satellites, was declared operational in 1985.²⁷¹

Cospas-Sarsat experimental operations began in 1982. The first satellite carrying Sarsat equipment, NOAA-8, was launched in 1983. Additional countries joined the system during the 1980s. In 1984, NASA turned the U.S. Sarsat leadership over to NOAA but retained its role in the areas of research and development.²⁷²

On July 1, 1988, the four countries providing the space segment (United States, Canada, France, and the Soviet Union) signed the International Cospas-Sarsat Program Agreement, which ensured the continuity of the system and its availability to all countries on a non-discriminatory basis.²⁷³ In January 1992, the government of Russia assumed responsibility for the obligations of the former Soviet Union. A number of states that were non-parties to the agreement also associated themselves with the program.²⁷⁴

²⁷¹ *Introduction to the Cospas-Sarsat System, Issue 5—Revision 1*, October 1999, p. 2-1, <http://www.cospas-sarsat.org/DocumentsGSeries/g3oct29.pdf> (accessed March 3, 2006).

²⁷² Rumerman, *NASA Historical Data Book*, volume VI, pp. 47–49.

²⁷³ The International Cospas-Sarsat Programme Agreement, <http://www.cospas-sarsat.org/Management/managementStructures.htm> (accessed March 3, 2006).

²⁷⁴ “History of Cospas-Sarsat,” <http://www.cospas-sarsat.org/Management/history.htm> (accessed March 3, 2006).

The Cospas-Sarsat system used two different complementary types of satellites. The low-Earth-orbit system provided coverage of the polar regions (which were beyond the coverage of geostationary satellites), could calculate the location of distress events using Doppler processing techniques, and was less susceptible to obstructions that might block a beacon signal in a given direction because the satellite was continuously moving with respect to the beacon.²⁷⁵ The geosynchronous satellite system could provide almost immediate alerts in the footprint of the satellite. Originally limited to polar LEO satellites, GOES-7—launched in 1987—as the first geosynchronous satellite to carry experimental search-and-rescue equipment. GOES-8—launched in 1994—was the first geosynchronous satellite to carry an operational Sarsat system. The geostationary portion of Cospas-Sarsat was declared operational in 1998.²⁷⁶

In 1994, testing of the first GPS-based prototype self-locating beacons began. In 1996, experiments were performed with beacon tracking in moving vehicles and airplanes.²⁷⁷ In September 1997, a Canadian study revealed that a constellation of mid-Earth orbiting (MEO) satellites could be used to augment the existing LEO and geosynchronous Cospas-Sarsat system by providing a vastly improved space-based distress alerting and locating capability. NASA, in coordination with the USAF GPS Program Office and Sandia National Laboratories, determined that the GPS constellation would be the best and most cost-effective MEO satellite constellation to host the search-and-rescue instruments. This project was called the Distress Alerting Satellite System (DASS). NASA committed funds to develop a proof-of-concept system for DASS,

²⁷⁵ “System Concept,” <http://www.cospas-sarsat.org/Description/concept.htm> (accessed March 3, 2006).

²⁷⁶ “Cospas-Sarsat History,” http://searchandrescue.gsfc.nasa.gov/cospas_sarsat/history.html (accessed May 23, 2007).

²⁷⁷ “Cospas-Sarsat History.”

including the funds to modify up to 30 instruments for deployment on future GPS satellites and the installation of a proof-of-concept DASS ground station at GSFC.²⁷⁸

Attached Shuttle Payload Bay Applications Missions

Every Space Shuttle mission provides a platform for performing scientific experiments. NASA used the Shuttle's microgravity environment for a variety of large experimental missions, smaller experiments, and small, self-contained payloads. Among these experiments and payloads were the Spacelab missions and various commercial investigations, such as those carried in SPACEHAB modules. (See the individual Space Shuttle mission tables in chapter 3, "Human Spaceflight" of volume VII of the *NASA Historical Data Book, 1989–1998*.) Attached applications missions are described more fully in this section.²⁷⁹

Life sciences and microgravity missions are neither Earth science nor applications missions. During NASA's history, these missions have been dispersed among different NASA Headquarters functions and offices. In the first part of the 1989–1998 decade, these missions were managed by OSSA. In the second half of the decade, life sciences and microgravity missions were managed by their own organization, the Office of Life and Microgravity Sciences and Applications (OLMSA). Life sciences and microgravity missions have always been closely tied to human spaceflight missions, since one of their primary purposes is to investigate how humans respond to the microgravity of space. A discussion of the management of OLMSA is included in chapter 3, "Human Space Flight," of volume VII of this data book. However, because life sciences and microgravity missions have continued to be funded primarily by the

²⁷⁸ "Distress Alert Satellite System," <http://searchandrescue.gsfc.nasa.gov/dass/index.htm> (accessed March 3, 2006).

²⁷⁹ Attached missions or attached payloads are those carried on board the Space Shuttle (usually physically "attached" to the Shuttle's structure).

Research and Development or the Science, Aeronautics, and Technology appropriation, rather than by Human Space Flight, full descriptions of the missions are given in this chapter.

Spacelab Life Sciences Missions

The Spacelab Life Sciences missions provided an opportunity for scientists to study the human body's response to spaceflight, specifically by examining how microgravity and the return to Earth's gravity affect particular body systems and parts.

Spacelab Life Sciences (SLS)-1

The SLS-1 mission, which launched aboard STS-40 on June 5, 1991, provided the first opportunity since the Skylab missions of the 1970s to comprehensively study adaptive changes in human physiology upon exposure to microgravity. It was the first mission dedicated to the life sciences with investigations to determine how living and working in space could affect the human body. The primary objective was to study the mechanisms, magnitudes, and time courses of certain physiological changes occurring during spaceflight, and to investigate the consequences of the body's adaptation to microgravity and its readjustment to Earth's gravity.²⁸⁰ Secondary objectives included test and verification of the hardware and protocols required to conduct animal research and carry on advanced medical care on humans in a space-based laboratory environment, conducting special operational medicine studies for the Extended Duration Orbiter Medical Program (EDOMP), maximizing the science return from the use of inflight animals by including domestic and international partners in a Biospecimen Sharing

²⁸⁰ Lennard Fisk, memo to the NASA Administrator accompanying Spacelab Life Sciences-1 Prelaunch Mission Operations Report, May 16, 1991, NASA History Division folder 008885, Historical Reference Collection, NASA Headquarters, Washington, DC. Also *Spacelab Life Sciences I: First Space Laboratory Dedicated to Life Sciences Research*, NASA Publication 120 (Houston: Johnson Space Center, 1989), p. vii.

Program, and performing microgravity sciences experiments in the Spacelab.²⁸¹ Data collection emphasized inflight human cardiovascular and metabolic experiments, pre- and postflight human vestibular experiments, and pre- and postflight animal experiments.²⁸² This nine-day mission was also the first flight since 1985 to use the Spacelab long module, which provided a pressurized “shirt-sleeve” environment for crew operations.²⁸³

Preparation for the mission began in 1978 when NASA Headquarters issued an announcement of opportunity for flight experiments that would fulfill the goals of the SLS-1 mission. The international scientific community responded by submitting almost 400 proposals. From these, some 100 proposals were selected for further evaluation by a Life Sciences Steering Committee that rated each experiment’s scientific and technical merits and decided whether it related to the goals of the Life Sciences Flight Experiment Program. Based on this review, the NASA Headquarters Space Sciences Steering Committee recommended investigations to the NASA Associate Administrator for Space Science, who made the final decision to approve the SLS-1 payload.

Each experiment was then assigned to a NASA project office—human experiments to NASA’s Johnson Space Center (JSC), and non-human experiments to ARC. The PI for each experiment worked with the appropriate project office to define costs, schedules, and plans for designing,

²⁸¹ “Spacelab Life Sciences 1 Post Launch Mission Operation Report,” Report No. S-977-90-40-04, p. 2., NASA History Division folder 008885, Historical Reference Collection, NASA Headquarters, Washington, DC.

²⁸² “STS-58 Press Information and Mission Time Line,” October 1993, Rockwell International Space Systems Division, Office of Customer and Media Relations, p. 1, http://www.jsc.nasa.gov/history/shuttle_pk/mrk/FLIGHT_058-STS-058_MRK.pdf (accessed January 25, 2006).

²⁸³ Lennard Fisk, memo to the NASA Administrator accompanying Spacelab Life Sciences-1 Prelaunch Mission Operations Report, May 16, 1991, NASA History Division folder 008885, Historical Reference Collection, NASA Headquarters, Washington, DC. See chapter 3 of volume VII of this data book for a description of Spacelab components.

fabricating, and testing hardware. Overall SLS-1 management was assigned to Johnson Space Center.

About a year before launch, each piece of hardware was shipped to Kennedy Space Center, and the total payload was assembled and installed in the Spacelab. About a month before launch, the Spacelab was installed in the Shuttle. After launch, mission operations were handled from the Payload Operations Control Center at Marshall Space Flight Center.²⁸⁴

The research subjects of SLS-1 were the astronauts on board the Shuttle, 30 rodents, and thousands of jellyfish. The primary SLS-1 experiments studied six body systems:

1. Cardiovascular/cardiopulmonary (heart, lungs, and blood vessels)
2. Renal/endocrine (kidneys and hormone-secreting organs and glands)
3. Blood (blood plasma)
4. Immune system (white blood cells)
5. Musculoskeletal (muscles and bones)
6. Neurovestibular (brain, nerves, eyes, and inner ear)

Of the 18 investigations, 10 involved humans, 7 involved rodents, and 1 used jellyfish (see table 2-91). Specific experiments were designed to validate the use of animal models for studying biomedical problems related to microgravity adaptation. Additionally, test and verification of hardware and protocols required to conduct animal research and advanced medical care on

²⁸⁴ *Spacelab Life Sciences-1: First Space Laboratory Dedicated to Life Sciences Research* (Houston, TX: Johnson Space Center, NASA Publication 120, 1989), pp. 38–39.

humans in a space-based laboratory environment were performed.²⁸⁵ The seven-person crew worked one 12-hour shift each day and kept the same sleep/wake cycle throughout the mission.

Figure 2-30 shows one of the experiments in progress.

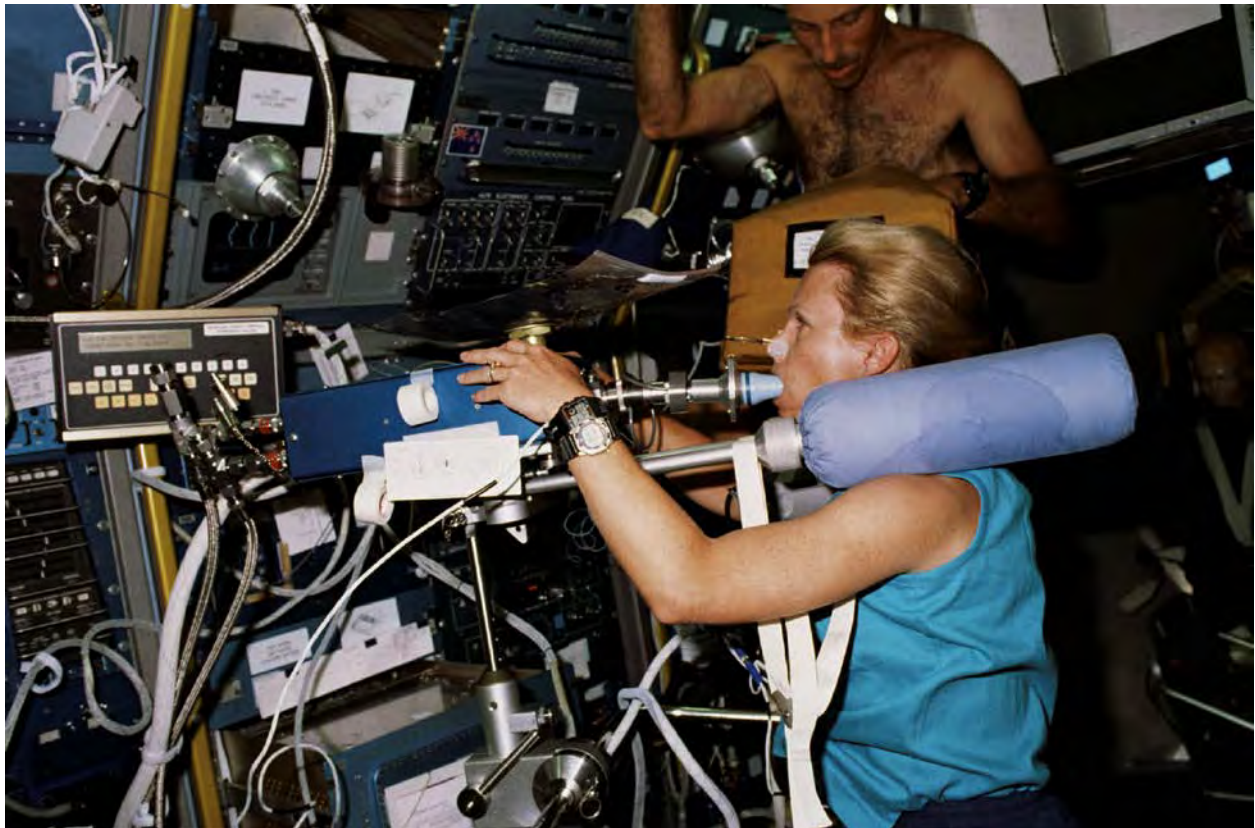

Figure 2-30. Astride the bicycle ergometer, NASA mission specialist Rhea Seddon breathes into the cardiovascular rebreathing unit during the exercise phase of an experiment on Spacelab Life Sciences-1. The investigation (Inflight Study of Cardiovascular Deconditioning) of the heart and lungs, and changes in cardiopulmonary function that occur upon return to Earth (NASA photo STS40-211-019).

All primary and secondary mission objectives were met. The Research Animal Holding Facility and Animal Enclosure Modules demonstrated their capability to house and sustain inflight

²⁸⁵ Lennard Fisk, memo to the NASA Administrator accompanying “Spacelab Life Sciences-1 Post Launch Mission Operations Report,” August 12, 1991, NASA History Division folder 008885, Historical Reference Collection, NASA Headquarters, Washington, DC.

research animals. All rodents flown on SLS-1 returned safely at the end of the mission.²⁸⁶ Table 2-91 lists SLS-1 investigations.

Spacelab Life Sciences (SLS)-2

SLS-2 launched on STS-58 on October 18, 1993. During the 14-day mission, which used the Spacelab long module, the crew operated on 9-hour shifts to conduct a set of 14 primary life sciences experiments, as well as several additional experiments investigating the effects of weightlessness on humans and animals. Mission objectives were to:

- Conduct an interdisciplinary study of the human and animal responses that occur when weightlessness is achieved, with major emphasis on cardiovascular and renal/endocrine responses to acute fluid shifts
- Conduct an interdisciplinary set of studies of the most significant known problems of adaptation to microgravity and readaptation to Earth's gravity, with special emphasis on issues in the cardiovascular/cardiopulmonary, neuroscience, regulatory physiology, and musculoskeletal disciplines
- Use microgravity to study biomedical questions relevant to medical problems on Earth and contribute to our understanding of basic biological processes²⁸⁷

Eight of the primary experiments focused on the seven-person crew, and six focused on the 48 rodents, the largest quantity flown on a single flight. The crew collected more than 650 different samples from themselves and the rodents, increasing the statistical base for life sciences

²⁸⁶ "Spacelab Life Sciences 1 Post Launch Mission Operation Report," Report No. S-977-90-40-04, p. 3., NASA History Division folder 008885, Historical Reference Collection, NASA Headquarters, Washington, DC.

²⁸⁷ "Spacelab Life Sciences Post Launch Mission Operation Report," NASA Office of Microgravity Sciences and Applications Report No. U-420-68-93-58, p. 1, NASA History Division folder 008891, Historical Reference Collection, NASA Headquarters, Washington, DC.

research. The mission continued the life sciences investigations begun on SLS-1 in June 1991. Although 11 of the investigations were performed on SLS-1, this mission was designed to help NASA answer critical questions about human physiological functions in space to prepare for long-duration stays aboard a space station or for lengthy travel to Mars and other planets.²⁸⁸

The cardiovascular/cardiopulmonary experiments focused on understanding and quantifying the changes that occur on orbit and on the acute fluid shift and the long-term adaptation of the heart and lungs. Regulatory physiology experiments investigated the theory that the kidneys and endocrine glands adjust the body's fluid-regulating hormones to stimulate an increase in fluid to be excreted. These experiments also investigated the mechanisms surrounding the decrease in red blood cells, which are responsible for carrying oxygen to the tissues, that occurs in spaceflight. Neuroscience investigations documented both physical vestibular (balance) changes and perception changes and investigated the mechanisms involved. Investigators also hoped to identify countermeasures to alleviate the effects of space motion sickness. Musculoskeletal investigations examined the effect of microgravity on the body's bones and muscles, which are used less extensively in space than on Earth, and, as a result, decrease in mass during spaceflight.²⁸⁹ The absence of gravitational force results in changes to load-bearing tissues, causing a reduction of bone and muscle.²⁹⁰

²⁸⁸ "STS-58 Press Information and Mission Time Line," October 1993, Rockwell International Space Systems Division, Office of Customer and Media Relations, p. 1,

http://www.jsc.nasa.gov/history/shuttle_pk/mrk/FLIGHT_058-STS-058_MRK.pdf (accessed January 25, 2006).

²⁸⁹ "Space Shuttle Mission STS-58 Press Kit," September 1993, pp. 16–25,

http://www.jsc.nasa.gov/history/shuttle_pk/pk/Flight_058_STS-058_Press_Kit.pdf (accessed January 22, 2006).

²⁹⁰ "Life Sciences Data Archive: Experiment," Johnson Space Center,

http://www.lstda.jsc.nasa.gov/scripts/mission/miss.cfm?mis_index=7&program_index=8 (accessed January 18, 2007).

This mission included an Astronaut Science Advisor (ASA), a computer-based intelligent assistant designed to help astronauts work more efficiently and improve the quality of space science. The ASA supported the Rotating Dome Experiment, which measured how the visual and vestibular systems interact, and how this interaction is affected as humans adapt to microgravity.²⁹¹ Table 2-92 lists SLS-2 investigations.

International Microgravity Laboratory (IML)

The International Microgravity Program was an international program dedicated to the study of life and materials sciences in microgravity. The missions explored how life forms adapt to weightlessness and how materials behave when processed in space.²⁹²

International Microgravity Laboratory-1

IML-1 was the primary payload on Space Shuttle mission STS-42, launched January 22, 1992. It was the first in a series of international Shuttle flights dedicated to fundamental life and microgravity sciences research.²⁹³ IML-1 science operations were a cooperative effort between the orbiting *Discovery*'s crew and mission management, scientists, and engineers in a control facility at MSFC. The eight-day IML-1 mission used the Spacelab long module

Mission objectives for IML-1 were to conduct scientific and technological investigations in microgravity—specifically experiments on life sciences, materials sciences, and fluid physics using several experimental facilities (see table 2-93). To complete as many experiments as

²⁹¹ “Space Shuttle Mission STS-58 Press Kit,” September 1993, pp. 21–22.

²⁹² “ESA—IML-1,” European Space Agency Public Relations, NASA History Division folder 008629, Historical Reference Collection, NASA Headquarters, Washington, DC.

²⁹³ The flight was extended one day over the originally planned seven days to continue the investigations.

possible, the international crew divided into red and blue teams to work around the clock in two 12-hour shifts. They conducted experiments on the human nervous system's adaptation to low gravity and the effects of microgravity on other life forms, such as shrimp eggs, lentil seedlings, fruit fly eggs, and bacteria. Low-gravity materials processing experiments included crystal growth from a variety of substances, including enzymes, mercury iodine, and a virus (see table 2-94). Much of the crew's time during the mission was devoted to experiments measuring how their own bodies adapted to living in space.²⁹⁴

IML-2

IML-2 was the primary payload on STS-65. Launched on July 8, 1994, the seven-person mission carried more than twice the number of experiments and facilities as the first IML mission in 1992. More than 80 experiments representing more than 200 scientists from six space agencies were located in the IML Spacelab module in the payload bay. The space agencies represented were NASA, ESA, CSA, CNES, DARA, and NASDA.

Two teams of crew members performed research around the clock on the behavior of materials and life in near weightlessness on the mission, which lasted almost 15 days. Fifty of the experiments related to life sciences, including bioprocessing, space biology, human physiology, and radiation biology. Some of the equipment used for these investigations had flown on previous Spacelab flights, such as ESA's Biorack, which was making its third flight. The IML-2 Biorack housed 19 experiments that featured chemicals and biological samples such as bacteria, mammalian and human cells, isolated tissues and eggs, sea urchin larvae, fruit flies, and plant seedlings. DARA provided the NIZEMI, a slow-rotating centrifuge used to study how organisms

²⁹⁴ "Space Shuttle Mission STS-42 Press Kit," January 1992, p. 16.

react to different gravity levels. Samples studied included jellyfish and plants. For the first time, researchers could determine how organisms reacted to forces one and one-half times Earth's gravity. Figure 2-31 shows the inside of the IML-2 module.



Figure 2-31. Astronaut Carl E. Walz, mission specialist, flies through the IML-2 science module. The mission explored how life forms adapt to weightlessness, and how materials behave when processed in space (NASA photo MSFC-9500974).

Nearly 30 experiments in materials processing were conducted with nine different types of science facilities. DARA provided the TEMPUS (the Electromagnetic Containerless Processing Facility), which was flying for the first time on IML-2, to study the solidification of materials from the liquid state in a containerless environment. Solidification phenomena are of great interest to scientists and are also used in many industrial processes. Science teams detected for the first time a phase in a nickel-niobium sample that was masked by other forces on Earth. Another facility, the Advanced Protein Crystallization Facility developed by ESA, was flying for the second time. Housed in two middeck lockers, it operated autonomously after being activated on the first flight day. Some 5,000 video images were made of crystals grown during flight.

The mission further advanced the concept of telescience, which enabled researchers on the ground to monitor in real time experiments on board the orbiter. The flight set a new record of more than 25,000 payload commands issued from Spacelab Mission Operations Control at Marshall Space Flight Center. Table 2-95 lists the IML-2 investigations.

Atmospheric Laboratory for Applications and Science (ATLAS) Missions

ATLAS missions were part of Phase 1 of NASA's MTPE, as well as an element of the U.S. Global Change Research Program. The program involved scientists from many Earth system science disciplines investigating terrestrial, climatic, atmospheric, and solar interactions.²⁹⁵

The main objective of the ATLAS series was to study solar output and the chemistry and dynamics of the middle atmosphere and to contribute to scientific calibrated solar and atmospheric measurements over an 11-year solar cycle.²⁹⁶ Such measurements are important because even small changes in the Sun's total irradiance or its spectral distribution can significantly influence Earth's climate. Similarly, changes in the quantity of trace gases in the atmosphere could affect climate and have other impacts. Throughout the series, scientists gathered new information to gain a better understanding of how the atmosphere reacts to natural and human-induced atmospheric changes, with the aim of identifying measures to keep Earth suitable for life for future generations.²⁹⁷ Beyond its own science mission, a key goal of the ATLAS series was to provide calibration for UARS. Two ATLAS-1 instruments—ACR and the

²⁹⁵ "ATLAS 1 Preflight Mission Operation Report," NASA Office of Space Science and Applications Report No. S-420-45-92-01, p. 1, NASA History Division electronic record 8642, Historical Reference Collection, NASA Headquarters, Washington, DC.

²⁹⁶ "ATLAS 1 Preflight Mission Operation Report," p. 11, NASA History Division electronic record 8642, Historical Reference Collection, NASA Headquarters, Washington, DC.

²⁹⁷ "Atlas 1—Atmospheric Laboratory for Applications and Science," <http://users.skynet.be/on1cau/atlas.htm> (accessed January 5, 2006).

SUSIM—had direct counterparts aboard UARS, while other instruments aboard each ATLAS mission were closely related. Repeated flights of the ATLAS instruments, which were carefully calibrated before and after each flight, provided long-term calibration datasets for comparison with data from many satellite instruments and for long-term trend studies.²⁹⁸

Each ATLAS flight crew was divided into two teams that worked approximately 12 hours followed by 12 hours off duty. This allowed for continuous payload operations 24 hours per day. At least one member of each team had special training in both Spacelab and experiment operations and supervised science activities on the shift.²⁹⁹

ATLAS-1

The first ATLAS mission launched on Space Shuttle STS-45 on March 24, 1992. There were two mission objectives. The first was to conduct experiments to study the chemistry, physics, and dynamics of the middle atmosphere; measure the energy output of the Sun; study how magnetic fields and electrified gases link the Sun and Earth; and examine sources of ultraviolet radiation in the Milky Way and other galaxies. The second objective was to obtain additional global ozone concentration data using the SSBUV/A investigation and to correlate data obtained from ATLAS-1, SSBUV/A, and UARS.³⁰⁰

²⁹⁸ “Space Shuttle Mission STS-45 Press Kit,” March 1992, http://www.jsc.nasa.gov/history/shuttle_pk/pk/Flight_046_STS-045_Press_Kit.pdf (accessed January 28, 2006).

²⁹⁹ “ATLAS 2,” NASA Fact Sheet, NASA Marshall Space Flight Center, NASA History Division folder 8686, Historical Reference Collection, NASA Headquarters, Washington, DC.

³⁰⁰ SSBUV was comanifested with ATLAS-1. It was physically separate from the ATLAS payload, mounted in two Get Away Special (GAS) canisters in the Shuttle’s payload bay. SSBUV commands were sent from a Payload Operations Control Center at Johnson Space Center. SSBUV data were received at Johnson and at Marshall Space Flight Center. “ATLAS 1 Preflight Mission Operation Report,” p. 11, NASA History Division electronic record 8642, Historical Reference Collection, NASA Headquarters, Washington, DC.

Over nine days of investigations, researchers met all primary and secondary mission objectives. The scientific data collected comprised an impressive set of measurements for the highly calibrated atmospheric and solar radiation instruments that would be used as a basis for long-term solar-cycle investigations and to provide validation information and complementary science for several satellite projects.³⁰¹ Among its investigations, the mission measured at various altitudes the concentrations of chemicals resulting from the breakdown of CFCs. These observations were the most direct confirmation that CFCs were the source of increased chlorine in the atmosphere.³⁰²

The ATLAS-1 mission used two Spacelab pallets in the orbiter's cargo bay and an igloo to accommodate a payload of solar and atmospheric monitoring instruments plus reflights of some earlier Spacelab investigations. An international team of researchers from the United States, France, Germany, Belgium, the United Kingdom, Switzerland, the Netherlands, and Japan provided 13 instruments that performed 14 investigations in atmospheric chemistry, solar radiation, space plasma physics, and ultraviolet astronomy. The experiments are listed in table 2-96.

ATLAS-2

ATLAS-2 was the primary payload on Space Shuttle mission STS-56, which launched April 8, 1993, on a nine-day mission.³⁰³ The Spacelab pallet in the payload bay held six instruments, and

³⁰¹ Associate Administrator for Space Science and Applications, memo to NASA Administrator accompanying ATLAS-1 Post Launch Mission Operation Report, S-420-45-92-01, NASA History Division electronic record 8642, Historical Reference Collection, NASA Headquarters, Washington, DC.

³⁰² "Space Shuttle Mission STS-66 Press Kit," November 1994, p. 14, http://www.jsc.nasa.gov/history/shuttle_pk/pk/Flight_066_STS-066_Press_Kit.pdf (accessed January 27, 2006).

³⁰³ The mission was extended from eight to nine days because of unacceptable weather conditions at the landing site at Kennedy Space Center. Spacelab was repowered to collect additional science measurements after the landing was deferred.

a seventh was mounted in two Get Away Special (GAS) canisters. Figure 2-32 shows ATLAS-2 in the Shuttle's cargo bay.

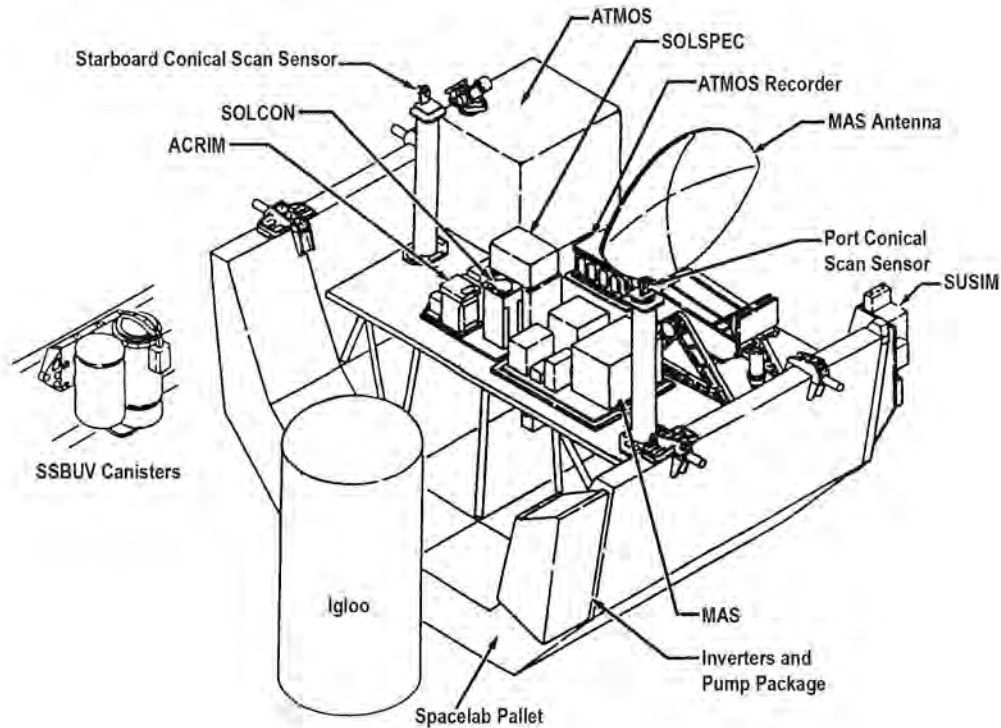

Figure 2-32. ATLAS-2 in the cargo bay (STS-66 Press Kit).

The ATLAS-1 mission established a baseline of atmospheric data against which researchers could measure future global change. ATLAS-2 and subsequent missions tracked subtle year-to-year variations in solar activity and atmospheric composition.

The ATLAS-2 experiments studied the chemistry, physics, and dynamics of the middle and upper atmosphere, and measured the Sun's energy entering Earth's atmosphere. Data were collected on the relationship between the Sun's energy output and Earth's middle atmosphere, and their effect on the ozone layer. ATLAS-2 measured middle-atmospheric ingredients over

high northern latitudes during daylight hours, which helped scientists understand the atmosphere's behavior following a winter of record low ozone levels. Indications were that total ozone decreased by 10 percent at mid-latitudes in the Northern Hemisphere during the period between the ATLAS-1 and ATLAS-2 flights.³⁰⁴ Unique investigations for ATLAS-2 involved the underflight of operating satellites so that correlative measurements could be made.³⁰⁵ Investigations are listed in table 2-97.

ATLAS-3

The third flight of the ATLAS payload took place in November 1994 on STS-66. From their location on a Spacelab pallet in the Shuttle cargo bay, seven instruments focused on the processes that could create and destroy ozone. The instruments, which included the Shuttle Solar Backscatter Ultraviolet Radiometer, provided checks on data from several identical or similar instruments flying aboard NASA and NOAA satellites.³⁰⁶ They measured precise levels of more than 30 chemicals in the environment, as well as global middle-atmosphere temperatures and trace-gas concentrations, providing these measurements to the science community for comparisons with those of other spacecraft.³⁰⁷ In addition, because of factors such as the time of year, orbital lighting conditions, the current state of knowledge about the atmosphere, and new instruments, some goals were unique to the ATLAS-3 mission. Atmospheric instruments on ATLAS-3 examined the response of the Southern Hemisphere to the Antarctic ozone hole and the change in Earth's northern middle atmosphere from relatively quiet summer conditions to

³⁰⁴ "Space Shuttle Mission STS-66 Press Kit," November 1994, p. 14, http://www.jsc.nasa.gov/history/shuttle_pk/pk/Flight_066_STS-066_Press_Kit.pdf (accessed January 27, 2006).

³⁰⁵ S.G. Tilford, memo to the NASA Administrator accompanying the ATLAS 2 Post Launch Mission Operation Report, NASA Office of Space Science and Applications Report No. S-420-56-93-01, NASA History Division folder 8686, Historical Reference Collection, NASA Headquarters, Washington, DC.

³⁰⁶ "NASA's Mission to Planet Earth: Space-Based Missions, 1994–2000," NASA Facts, February 1994.

³⁰⁷ *Aeronautics and Space Report of the President, Fiscal Year 1995 Activities*, p. 60.

more active winter conditions. Furthermore, the presence of two additional instruments on the free-flying Cryogenic Infrared Spectrometers and Telescopes for the Atmosphere–Shuttle Pallet Satellite (CRISTA-SPAS), also flying on STS-66, enhanced ATLAS atmospheric data and provided more information on gas concentrations, including details of their physical distribution.

The mission was exceedingly successful, with eight of the nine instruments performing nearly flawlessly. Since almost all of the science teams could turn data around in essentially real time, they could obtain preliminary atmospheric mixing ratio profiles, solar spectra, and total solar irradiance values during the mission. All of the instruments downlinked data and examined spectra in order to assess instrument performance. Through cooperation among the PIs, several comparison studies were performed for both atmospheric and solar objectives. The results were also compared with those from other spacecraft, particularly UARS. Additionally, several “joint experiments” were carried out during the mission, including some that were planned during the mission after investigators received preliminary data.³⁰⁸

The Millimeter-Wave Atmospheric Sounder (MAS) failed during the first day of the mission but still gathered 10 hours of data, enough to obtain nearly global maps of ozone and water vapor in the stratosphere and mesosphere, as well as some information on distribution of chlorine monoxide in the stratosphere.³⁰⁹ Table 2-98 lists the ATLAS-3 investigations.

³⁰⁸ “Atmospheric Laboratory for Applications and Science (ATLAS-3), Cryogenic Infrared Spectrometers and Telescopes for the Atmosphere—Shuttle Pallet Satellite (CRISTA-SPAS-1), Shuttle Solar Backscatter Ultraviolet/A (SSBUV/A) Post Launch Mission Operation Report,” Office of Mission to Planet Earth, Office of Life and Microgravity Sciences and Applications, Report No. U-959-66-94-01, May 4, 1995, p. 3, NASA History Division folder 011051, Historical Reference Collection, NASA Headquarters, Washington, DC.

³⁰⁹ “Atmospheric Laboratory for Applications and Science (ATLAS-3) Post Launch Mission Operation Report,” Report No. U-959-66-94-01, May 4, 1995, p. 3, NASA History Division folder 011051, Historical Reference Collection, NASA Headquarters, Washington, DC.

U.S. Microgravity Laboratory (USML)

The USML program was an early step toward building a microgravity program linking NASA, researchers in fundamental and engineering sciences, and private industry. Established through a congressional charter, it brought together representatives from academia, industry, and the government to study basic scientific questions. The USML was located in the Spacelab in the Shuttle's cargo bay and flew on orbit for extended periods. It provided greater opportunities for research in materials science, fluid dynamics, biotechnology, and combustion science while conducting experiments on nutrient and water transport for growing food in space, the behavior of fire in low gravity, and the effects of long-term space travel on humans.³¹⁰ The USML missions worked to develop and test experimental flight equipment and lay the scientific foundation for extended-duration microgravity research.

USML-1

USML-1 was the first Spacelab mission dedicated entirely to microgravity science and the first in a planned series of flights fully dedicated to microgravity research. It was the primary payload on Space Shuttle mission STS-50 and used the Spacelab's long pressurized module with its series of standard racks for holding furnaces to grow crystals, facilities for studying the behavior of fluids and performing combustion research, computers, and other equipment needed for the experiments.

³¹⁰ "The First United States Microgravity Laboratory," Payload Projects Office, NASA Marshall Space Flight Center, 1992, p.2, NASA History Division folder 008662, Historical Reference Collection, NASA Headquarters, Washington, DC. Also "Space Shuttle Mission STS-50 Press Kit," June 1992, p. 10, http://www.jsc.nasa.gov/history/shuttle_pk/pk/Flight_048_STS-050_Press_Kit.pdf (accessed January 24, 2006).

The primary USML-1 mission objective was to establish a space laboratory program with long-term continuity to build U.S. leadership in microgravity science and applications. Other mission objectives were to:

- Use the space environment to address important scientific and technical questions regarding materials science, fluid dynamics, biotechnology, and combustion science
- Enable cooperation among government, industry, and academia in an evolving partnership to explore and develop the potential of the space environment
- Offer U.S. science and commercial communities access to the sophisticated research capabilities of the Spacelab
- Build a base of experience for space station operations³¹¹

This mission was the first to use the Extended Duration Orbiter (EDO) pallet, a system that provided equipment and fuel for extra energy production, additional nitrogen tanks for cabin air, and a regeneration system to remove carbon dioxide to enable the orbiter to remain in orbit up to 16 days.³¹² The EDO medical program provided information about the effects of long-duration exposure to microgravity on humans.

Three facilities debuted on USML-1: the Crystal Growth Furnace (CGF), the Surface Tension Driven Convection Experiment (STDCE) Apparatus, and the Drop Physics Module (DPM).

³¹¹ “United States Microgravity Laboratory—USML-1,” Microgravity Science and Applications Division, June 1992, NASA History Division folder 008662, Historical Reference Collection, NASA Headquarters, Washington, DC. Also “United States Microgravity Laboratory 1 Mission Operation Report,” Report No. S-420-50-92-01, Office of Space Science and Applications, NASA History Division folder 008887, Historical Reference Collection, NASA Headquarters, Washington, DC.

³¹² “United States Microgravity Laboratory—USML-1,” Microgravity Science and Applications Division, June 1992, NASA History Division folder 008662, Historical Reference Collection, NASA Headquarters, Washington, DC. Also “Space Shuttle Mission STS-50 Press Kit,” June 1992, p. 10.

The CGF was a reusable Spacelab facility for investigating crystal growth. It was developed specifically to study high-temperature directional solidification of materials (primarily semiconductors), which form the basis of electronic devices. The CGF was the first spaceflight furnace developed by the United States to process multiple large samples at temperatures above 1,000°C (1,832°F), allowing scientists to conduct a wide variety of materials science investigations.³¹³

The STDCE Apparatus consisted of an experiment package and an electronics package located in a double Spacelab rack. The experiment package included a test chamber that was made of copper to ensure good thermal conductivity along the walls, and a silicone oil system consisting of a storage reservoir, and a fluid-management system for filling and emptying the test chamber. Two heating systems were part of the test chamber.³¹⁴

The DPM, developed by JPL, was dedicated to the detailed study of the dynamics of drops in microgravity, including their equilibrium shapes, flow dynamics, and both stable and chaotic behaviors. It also demonstrated a potentially valuable processing technique known as containerless processing. The module and microgravity combined to remove the effects of the container, such as chemical contamination and shape, on the sample being studied. Sound waves, generating acoustic forces, held a sample away from the walls of the experiment chamber, which isolated the sample from potentially harmful external influences. A variety of fluids, including

³¹³ “Crystal Growth Furnace,” <http://liftoff.msfc.nasa.gov/Shuttle/USML2/science/cgf.html> (accessed January 27, 2006).

³¹⁴ “The First United States Microgravity Laboratory,” Payload Projects Office, NASA Marshall Space Flight Center, 1992, p. 14, NASA History Division folder 008887, Historical Reference Collection, NASA Headquarters, Washington, DC.

very pure water, water with tiny amounts of contaminants, water with various amounts of glycerin to add viscosity, and silicone oils, flew on USML-1.³¹⁵

The Spacelab Glovebox (GBX), obtained by NASA through a cooperative agreement with ESA, was a multi-user facility supporting 16 experiments in fluid dynamics, combustion science, crystal growth, and technology demonstrations. It complemented or enhanced the results from the USML science investigations and provided additional information for the design and development of future microgravity experiments.³¹⁶ It also enabled crew members to handle, transfer, and otherwise manipulate materials in ways that would be impractical in an open Spacelab. Experiments were placed in the GBX via a central port, and crew members could access materials through that port and two glovedoors on each side of it. The GBX's enclosed compartment offered a clean working space and minimized the risk of contamination to the Spacelab and the experiment samples. It provided physical isolation and a negative air-pressure differential between the enclosure and the rest of the Spacelab working area for small quantities of materials. An air-filtering system also protected the Spacelab environment from experiment products that could harm the crew. The GBX's photographic equipment allowed crew members to make a visual record of experiment operations. It could also be used with accelerometers to characterize the low-gravity environment.³¹⁷ Video data could be downlinked in real time. The

³¹⁵ "The First United States Microgravity Laboratory," pp. 16–17.

³¹⁶ "United States Microgravity Laboratory—USML-1," Microgravity Science and Applications Division, June 1992, NASA History Division folder 008662, Historical Reference Collection, NASA Headquarters, Washington, DC.

³¹⁷ "Glovebox," NASA History Division folder 008887, Historical Reference Collection, NASA Headquarters, Washington, DC.

GBX also provided electrical power for experiment hardware, a time-temperature display, and cleaning supplies.³¹⁸

The mission also included the Space Acceleration Measurement System (SAMS) and Orbital Acceleration Research Experiment (OARE), a special accelerometer system that measured accelerations inside Spacelab. Such measurements were important because disturbances could cause convection and disrupt sensitive experiments. This equipment allowed investigators to trace any vibrations from Shuttle engine firings, crew motions, or disturbances from other instruments.³¹⁹ See table 2-99 for a list of USML-1 investigations.

USML-2

USML-2 was the primary payload on STS-73, which launched on October 20, 1995. Bringing together researchers from government, academia, and private industry, it was the second U.S. Spacelab mission dedicated to microgravity research. The mission consisted of 14 facilities performing 18 experiments and 7 investigations. Research concentrated on the same overall areas as USML-1, which flew aboard STS-50, including fluid dynamics, crystal growth, combustion science, biological science, and technology demonstrations. Many experiments flew for the second time, and some of the experiments arose from the outcome of investigations on USML-1. To maximize science on orbit and allow around-the-clock investigations, the seven-member crew split into two teams, each working 12-hour shifts.

³¹⁸ “Space Shuttle Mission STS-50 Press Kit,” June 1992, p. 34, http://www.jsc.nasa.gov/history/shuttle_pk/pk/Flight_048_STS-050_Press_Kit.pdf (accessed January 24, 2006).

³¹⁹ “United States Microgravity Laboratory 1 Mission Operation Report,” p. 11, NASA History Division folder 008887, Historical Reference Collection, NASA Headquarters, Washington, DC.

Along with investigations previously flown on USML-1, several new experiment facilities flew on this mission. The Advanced Protein Crystallization Facility (APCF) was the first facility to use three methods of protein crystal growth: liquid–liquid diffusion, dialysis, and vapor diffusion. The High-Packed Digital Television Technical Demonstration (HI-PAD) gave scientists on Earth the ability to view multiple channels of real-time video and to monitor and change experiment parameters as needed to improve the quality and quantity of downlinked data. It also enabled the PIs to take large quantities of video data from their experiments back to their research centers immediately after the flight. This technical demonstration could digitize up to six video input signals from experiments and Spacelab cameras on board USML-2 and downlink all of them. Without HI-PAD, only one video signal could be sent to the ground at a time.³²⁰ Ground-to-Air Television (GATV), which allowed the crew and scientists on the ground to both talk to and see each other, was first used on this mission. The Geophysical Fluid Flow Cell (GFFC) experiment, which was used to study how fluids moved in microgravity as a means of understanding fluid flow in oceans, atmospheres, planets, and stars, was extensively refurbished for this mission. It had first flown on Spacelab 3 in 1985.³²¹

Experiments measuring the microgravity environment provided a complete picture of the Shuttle’s environment and its disturbances. OARE provided real-time acceleration data to the science teams. The Microgravity Acceleration Workstation (MAWS) operated closely with OARE so that the environmental models produced by MAWS could be compared with the actual data gathered by OARE. The SAMS and the Three Dimensional Microgravity Accelerometer (3-

³²⁰ “The Experiments,” USML-2 Mission Archive,” <http://liftoff.msfc.nasa.gov/Shuttle/USML2/science/exp.html> (accessed January 27, 2006).

³²¹ “The Second United States Microgravity Laboratory 90-Day Science Report,” March 1996, pp. 8–9, <http://liftoff.msfc.nasa.gov/shuttle/usml2/90-day/usml-2-90day.pdf> (accessed January 26, 2006).

DMA) took measurements throughout the mission that were provided to the science community for analysis.³²²

Highlights of the mission included the discovery that crystals grown in space without touching the walls of their containers were of markedly higher quality than Earth-grown crystals. This was expected to promote the use of these crystals in critical electronics applications. Another finding—that surfactants can change the hydrodynamics of droplets—could lead to new and improved technologies for manufacturing cosmetics and synthetic drugs, as well as for the recovery of oil and cleanup of the environment. Another investigation revealed that droplets hit with sound lost symmetry and began to rotate. This discovery had implications for improved technologies in the pharmaceutical industry and chemical processing and for increasing our understanding of rain formation and weather patterns.³²³ Figure 2-33 shows crew members working inside USML-2. Table 2-100 lists USML-2 investigations.

³²² “The Second United States Microgravity Laboratory 90-Day Science Report,” March 1996, pp. 8–9.

³²³ “Significant Discoveries from Space Shuttle Experiments To Be Presented at Conference,” *NASA News Release* 97-23, February 5, 1997, NASA History Division folder 008860, Historical Reference Collection, NASA Headquarters, Washington, DC.



Figure 2-33. On-board photo of Space Shuttle Columbia (STS-73) crew members Fred Leslie (foreground) and Catherine Coleman aboard the USML-2 conducting experiments in a microgravity environment available in the orbiter's cargo bay while in low-Earth orbit (NASA photo MSFC-9515837).

Spacelab J

Spacelab J, the first Japanese Spacelab, was launched aboard Space Shuttle *Endeavour* (STS-47) on September 12, 1992. The mission was a cooperative effort by NASA and NASDA. Its scientific objectives were to conduct a variety of materials- and life-sciences experiments using the weightless and radiation environment of an orbiting Spacelab. Experiments were conducted in the Spacelab long module in the areas of microgravity science (materials processing, crystal growth, fluid physics, and acceleration measurement) and life sciences (physiology, developmental biology, radiation effects, separation processes, and enzyme crystal growth).³²⁴ The international crew was divided into red and blue teams for round-the-clock operations. The mission was successfully completed after eight days on orbit, which included an extra day of payload operations. Figure 2-34 shows Payload Specialist Mamoru Mohri from Japan preparing for the mission.

³²⁴ *Final Science Results, Spacelab J* (Washington, DC: Office of Life and Microgravity Sciences and Applications, NASA Headquarters, 1995), p. 1.



Figure 2-34. In the Operations and Checkout Building high bay at Kennedy Space Center, STS-47 Payload Specialist Dr. Mamoru Mohri participates in a Mission Sequence Test of the Spacelab-J (SL-J). Dr. Mohri was the first Japanese to fly on the Shuttle (NASA photo 92PC-1194).

Thirty-seven experiments were sponsored by NASDA, NASA sponsored seven, and two were jointly sponsored. The test subjects included crew members, Japanese koi fish, cultured animal and plant cells, chicken embryos, fruit flies, fungi and plant seeds, and frogs and frog eggs. All experiments on board were activated. Investigations are listed in table 2-101.

United States Microgravity Payload (USMP)

The USMP program consisted of a series of missions that provided scientists the opportunity to conduct scientific and technological research in materials and fundamental sciences in the microgravity environment of the Space Shuttle's payload bay. The USMP carrier of the 1990s built on the design of the Materials Science Laboratory (MSL), which flew on Space Shuttle mission STS-61-C in 1986. The new carrier consisted of two Mission Peculiar Equipment Support Structures (MPESSs) mounted next to each other and spanning the width of the orbiter. This carrier offered accommodations for twice as many investigations as the original MSL carrier, increased the resources available for each experiment, and improved data-handling and command capabilities. It could support up to six experiments with a total experiment mass up to 2,268 kilograms (5,040 pounds). Standardized mounting provisions were located on the tops and sides of each MPESS for attaching the science instruments directly to the truss structure.³²⁵

The USMP was manifested as a primary half-bay Shuttle payload and was allocated up to 50 percent of the total orbiter resources available for payloads. The experiments had access to data-handling, electrical-power, and thermal-control subsystems. All USMP carrier subsystems were located on the forward MPESS.

³²⁵ "United States Microgravity Payload, Missions Dedicated to Microgravity Research" NASA History Division folder 11035, Historical Reference Collection, NASA Headquarters, Washington, DC.

During a USMP mission, Shuttle crew members activated the USMP subsystems and instruments a few hours after launch. The experiments then functioned autonomously for the duration of on-orbit operations. At the same time, science teams worked on the ground at the Payload Operations Control Center at NASA's Marshall Space Flight Center, sending commands to their instruments to change experiment parameters and assess the performance of their investigations by analyzing data downlinked from the payload. After each mission, samples, instruments, and data were distributed to the investigators for analysis.³²⁶

Four USMP missions flew in the 1990s. MSFC was responsible for mission management and integration.

United States Microgravity Payload

Space Shuttle mission STS-52, launched on October 22, 1992, carried USMP-1. It was activated on the first day of the flight. On-board studies focused on the influence of gravity on basic fluid and solidification processes. The mission included three experiments mounted on two connected MPESs mounted in the cargo bay (see figure 2-35). The Lambda Point Experiment (LPE) studied fluid behavior in microgravity. The French-sponsored *Matériel pour l'Étude des Phénomènes Intéressant la Solidification sur Terre et en Orbite* (Materials for the Study of Interesting Phenomena of Solidification on Earth and in Orbit [MEPHISTO]) experiment studied metallurgical processes in microgravity. MEPHISTO was a cooperative effort by NASA, the French space agency (CNES), and the French Atomic Energy Commission (CEA). CNES developed the MEPHISTO experiment apparatus, and NASA provided the flight opportunities

³²⁶ "United States Microgravity Payload, Missions Dedicated to Microgravity Research," (NASA History Office folder 11035).

on the Space Shuttle. On this mission, the CEA solidification laboratory successfully used the MEPHISTO instrument in collaboration with the U.S. National Institute of Standards and Technology to collect data on the solidification of tin-0.5 atomic percent bismuth alloy.³²⁷ The Space Acceleration Measurement System (SAMS) studied the microgravity environment on board the Space Shuttle. See table 2-102 for USMP-1 investigations.

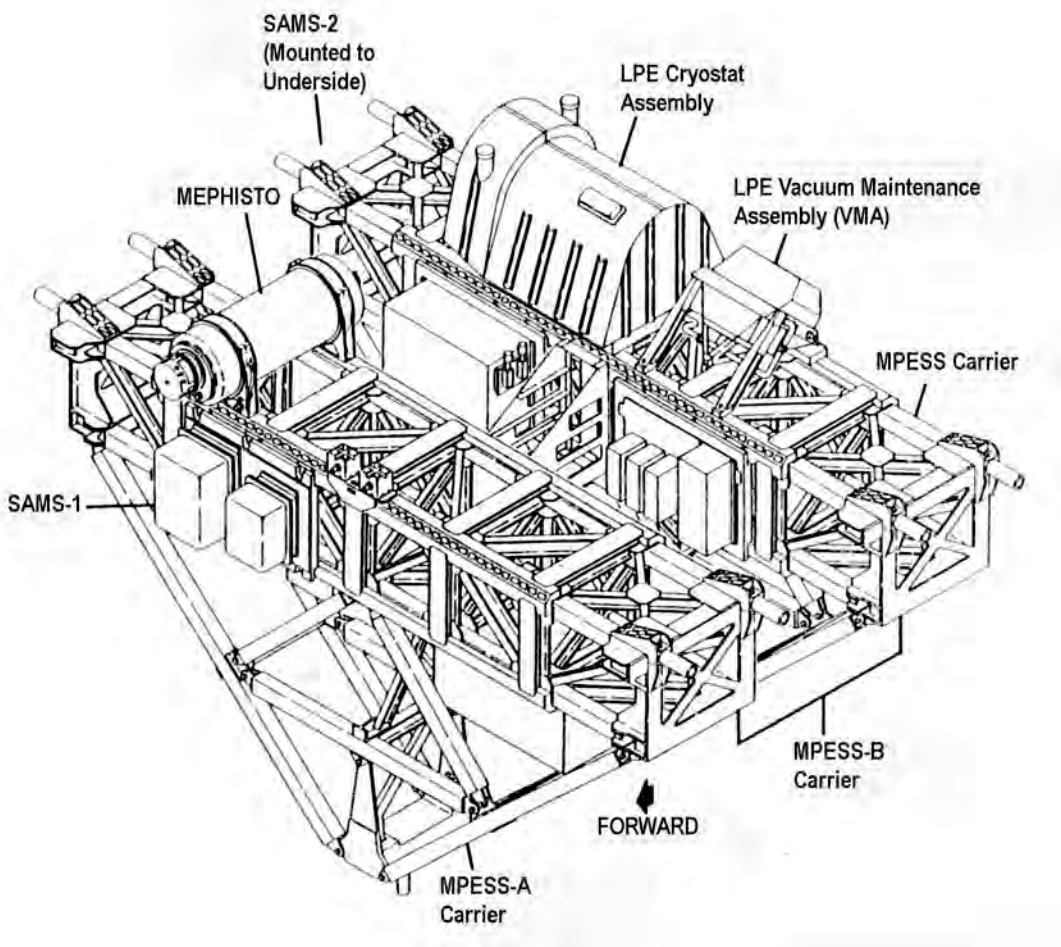

Figure 2-35. The USMP carrier consists of two Mission Peculiar Equipment Support Structures (MPESs) that support the Lambda-Point Experiment, MEPHISTO, and Space Acceleration Measurement Systems apparatus (STS-52 Press Kit).

³²⁷ “Matériel pour l’Étude des Phénomènes Intéressant la Solidification sur Terre et en Orbite (MEPHISTO), <http://liftoff.msfc.nasa.gov/shuttle/sts-75/usmp-3/exp/MEPHISTO.html> (accessed January 31, 2006).

United States Microgravity Payload

USMP-2 was one of two primary payloads on Space Shuttle mission STS-62, which launched on 4 March 1994.³²⁸ USMP-2 carried experiments in materials science and condensed matter physics. It characterized the microgravity environment using acceleration data obtained in support of experiment activities, adding to the base of experience necessary for remote operations during the ground-tended phase of early space station science activities.³²⁹

The four major experiments on USMP-2 investigated materials processing and crystal growth in microgravity (see table 2-103). On this mission, the University of Florida, together with the CEA, collected data on a bismuth-0.1 atomic percent tin alloy in the MEPHISTO experiment.³³⁰ In addition, the SAMS measured and analyzed microgravity disturbances caused by crew movements, equipment operations, Shuttle maneuvers, and the slight atmospheric drag on the Space Shuttle. The USMP-2 carrier, which was developed at Marshall, consisted of two MPESs spanning the payload bay. Experiment hardware was mounted on the support structures, and carrier subsystems providing electrical power, communications and data-handling capabilities, and thermal control were mounted on the front structure.³³¹

³²⁸ The second primary payload was the Office of Aeronautics and Space Technology (OAST-2) payload discussed in chapter 3 (“Aeronautics, Technology, and Exploration”) of this volume.

³²⁹ “STS-62, March 1994,” Office of Life and Microgravity Sciences and Applications, p. 6, NASA History Division folder 11035, Historical Reference Collection, NASA Headquarters, Washington, DC.

³³⁰ “Matériau pour l’Étude des Phénomènes Intéressant la Solidification sur Terre et en Orbite (MEPHISTO), <http://liftoff.msfc.nasa.gov/shuttle/sts-75/usmp-3/exp/MEPHISTO.html> (accessed January 31, 2006).

³³¹ “Space Shuttle Mission STS-62 Press Kit,” March 1994, p. 15, http://www.jsc.nasa.gov/history/shuttle_pk/pk/Flight_061_STS-062_Press_Kit.pdf (accessed January 31, 2006).

U.S. Microgravity Payload

USMP-3 was one of two primary payloads flying on Space Shuttle mission STS-75, which launched on February 22, 1996.³³² Major experiments included U.S. and international investigations that had flown at least once before. These primary experiments, located in the cargo bay mounted on the MPSS, investigated biotechnology, fluid physics, and materials science in microgravity. For the MEPHISTO experiment on this mission, the CEA collaborated with the University of Alabama in Huntsville to solidify a tin-1.5 atomic percent bismuth alloy. The USMP-3 experiments, which involved more concentrated alloys than those used in previous flights, studied the influence of composition on the transport process.³³³ In addition, two investigations—SAMS and OARE—precisely monitored and recorded vibrations and accelerations that could affect sensitive microgravity investigations. For the first time, SAMS allowed both the Shuttle crew and scientists on the ground to assess these disturbances and their influence on experiment results in real time by using a computer and monitor connected to a direct feed of SAMS sensor information.³³⁴

The mission also included three combustion experiments that used the Middeck Glovebox Facility (MGBX). This facility provided containment for crew safety while functioning as a laboratory workbench. It also had a multipurpose interface frame that provided electrical power conditioning and distribution and data collection.³³⁵ First developed and successfully flown on

³³² The second primary payload was the reflight of the Tethered Satellite System.

³³³ “Matériel pour l’Étude des Phénomènes Intéressant la Solidification sur Terre et en Orbite (MEPHISTO), <http://liftoff.msfc.nasa.gov/shuttle/sts-75/usmp-3/exp/MEPHISTO.html> (accessed January 31, 2006).

³³⁴ “The Fourth United States Microgravity Payload,” <http://liftoff.msfc.nasa.gov/shuttle/usmp4/brochure.pdf> (accessed February 1, 2006).

³³⁵ “USMP-3 Experiments,” <http://liftoff.msfc.nasa.gov/shuttle/sts-75/usmp-3/exp/exp.html> (accessed January 31, 2006).

the USML-1 in 1992, the MGBX was designed to operate in the Shuttle middeck, the *Mir* space station, and the International Space Station.³³⁶

Shuttle crew members activated the major USMP experiments on flight day 2. Once the microgravity experiments were running, most were remotely controlled in an operational mode known as “telescience.” Beginning on flight day 5, the crew carried out combustion experiments using the MGBX. While these experiments were underway, *Columbia*’s position was adjusted periodically to give the USMP experiments the best possible conditions based on measurements of microgravity disturbances by on-board sensors. During the mission, science teams on the ground monitored and adjusted the experiments as necessary based on data downlinked from *Columbia*.³³⁷ The USMP-3 experiments are listed in table 2-104.

United States Microgravity Payload

The fourth U.S. Microgravity Payload of the decade, USMP-4, flew as a primary payload on Space Shuttle mission STS-87, launched November 9, 1997.³³⁸ Mission experiments focused on materials science, combustion science, and fundamental physics. The major experiments operated without crew involvement. Additional experiments were housed in the MGBX. On this mission, the Advanced Automated Directional Solidification Furnace (AADSF) solidified crystals of two different alloys (lead tin telluride and mercury cadmium telluride), in contrast to the single lead tin telluride alloy solidified in USMP-3. The Isothermal Dendritic Growth Experiment (IDGE), flying for the third time, used a different sample material (pivalic acid [PVA]) from that used in earlier

³³⁶ “Middeck Glovebox (MGBX) Facility,” <http://liftoff.msfc.nasa.gov/Shuttle/STS-75/mgbx/MGBX.html> (accessed January 31, 2006).

³³⁷ “Space Shuttle Mission STS-75 Press Kit,” pp. 14, 22, http://www.jsc.nasa.gov/history/shuttle_pk/pk/Flight_075_STS-075_Press_Kit.pdf (accessed February 1, 2006).

³³⁸ The SPARTAN 201-04 satellite flew as second primary payload.

missions, allowing a more detailed study.³³⁹ The Confined Helium Experiment (CHeX) was performed for the first time on this mission. Table 2-105 lists USMP-4 investigations.

Spacelab D-2

The second German Spacelab mission, designated D-2, launched on Space Shuttle mission STS-55. Two crews working in round-the-clock shifts conducted approximately 88 experiments. Around 200 principals and co-investigators from 14 countries worldwide were represented.³⁴⁰ NASA sponsored four investigations.

The D-2 mission augmented the German microgravity research program started by the D-1 Spacelab mission in 1985. In addition to continuing research and scientific experiments from D-1, the D-2 mission was multidisciplinary, covering experiments related to materials science, life sciences, technology applications, Earth observations, astronomy, and atmospheric physics. The experimental program of the mission was oriented toward Germany's space-utilization program goals and the microgravity goals of ESA. Mission management was handled by the German Aerospace Research Establishment (DLR), and the German space agency (DARA) was in charge of program management. The DLR trained the astronauts and carried out flight planning, flight operations, and payload control and operations. The D-1 and D-2 missions were the only two Spacelab missions with payload-operations control located outside the United States.³⁴¹

Experiments are listed in table 2-106. Facilities and contributors are listed in table 2-107. Figure 2-36 shows the arrangement of the experiments in the Spacelab module.

³³⁹ "Isothermal Dendritic Growth Experiment (IDGE); The Fourth United States Microgravity Payload," <http://liftoff.msfc.nasa.gov/shuttle/usmp4/brochure.pdf> (accessed February 1, 2006).

³⁴⁰ Manfred H. Keller et al., "For Earth into Space: Results of the German Spacelab Mission D-2," AIAA-95-0891, American Institute of Aeronautics and Astronautics, 33rd Aerospace Sciences Meeting and Exhibit.

³⁴¹ "Space Shuttle Mission STS-55 Press Kit," February 1993, pp. 4, 13, http://www.jsc.nasa.gov/history/shuttle_pk/pk/Flight_055_STS-055_Press_Kit.pdf (accessed February 1, 2006).

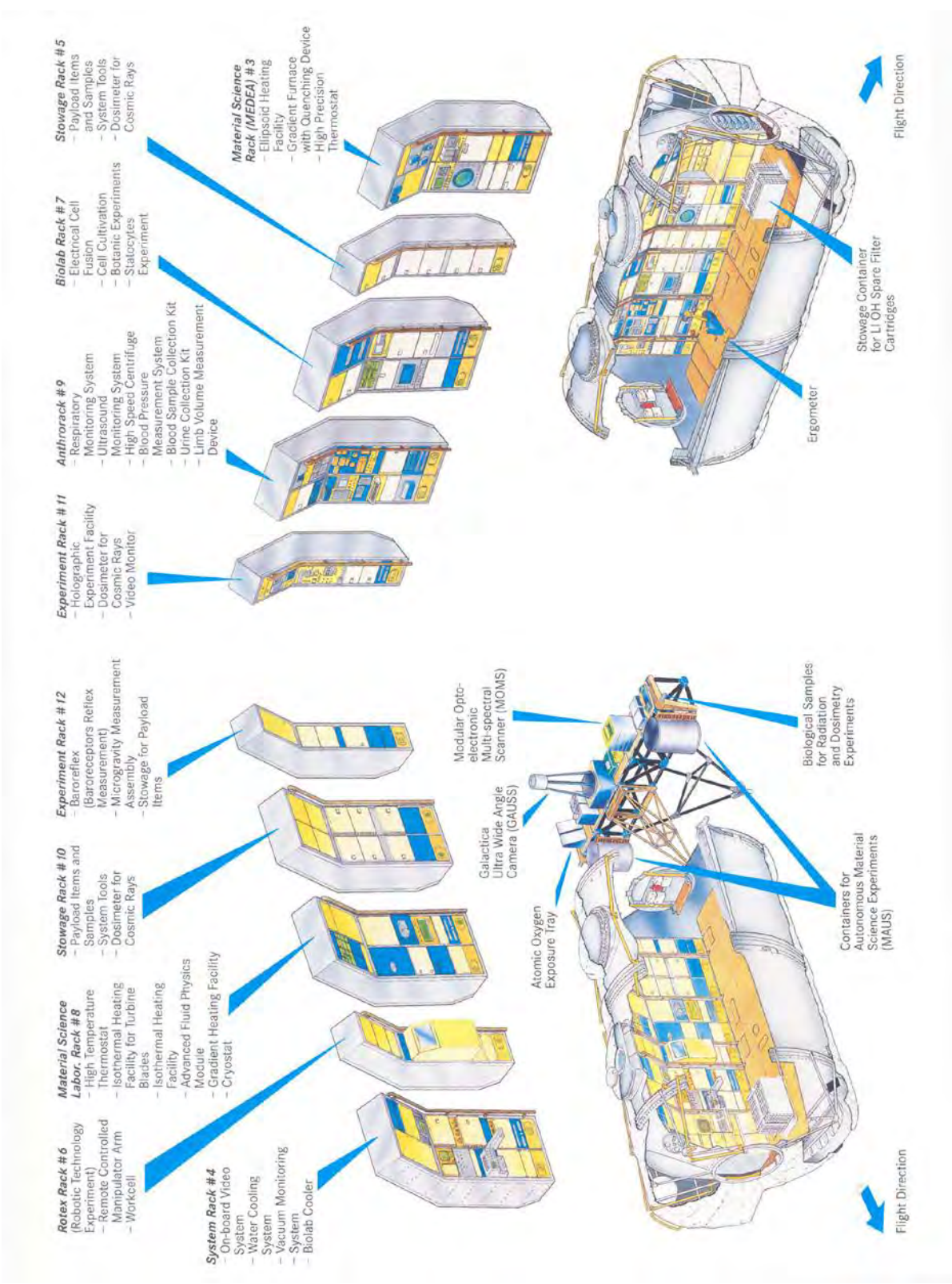

Figure 2-36. Arrangement of racks on Spacelab D-2 (NASA History Division Folder 008888, Historical Reference Section, NASA Headquarters, Washington, DC).

Space Radar Laboratory (SRL) Missions

The SRL missions on STS-59 and STS-68 carried two experiments: the Spaceborne Imaging Radar-C and X-Band Synthetic Aperture Radar (SIR-C/X-SAR) and the Measurement of Air Pollution from Satellites (MAPS).

The SIR-C/X-SAR was a Space Shuttle experiment conducted as a cooperative effort by NASA, the German space agency (DARA), and the Italian space agency (Agenzia Spaziale Italiana [ASI]). The experiment began with the Seasat Synthetic Aperture Radar (SAR) in 1978 and continued with the Spaceborne Imaging Radar-A (SIR-A) in 1981 and SIR-B in 1984. The SIR-C/X-SAR was a part of NASA's MTPE and a precursor to the EOS imaging radar system planned for later in the decade. The program also benefited from experience gained from the 1989 Magellan mission to Venus, other international spaceborne radar programs, and prototype aircraft sensors.³⁴²

Germany's imaging radar program began with the Microwave Remote Sensing Experiment (MRSE), a multimode X-band radar that was flown on the first Spacelab mission in 1983. The program continued with development of the X-SAR, with which Italy cooperated.³⁴³

With its ability to acquire digital image simultaneousl a two wavelengths, SIR-C was more capable than Seasat, SIR-A, and SIR-B. SIR-C made unique contributions to Earth observation and monitoring due to its ability to measure radar signature of the surface at three different wavelengths from space, and measure for different polarizations at two of those wavelengths.

³⁴² "What Is SIR-C/X-SAR?" <http://southport.jpl.nasa.gov/desc/SIRCdesc.html> (accessed February 2, 2006).

³⁴³ "SRL Science Mission Overview," <http://southport.jpl.nasa.gov/science/missiono.html> (accessed February 2, 2006).

SIR-C image data helped scientists understand the physics behind some of the phenomena observed in radar images at just one wavelength/polarization such as those produced earlier by Seasat. Investigators on the SIR-C/X-SAR science team used the SIR-C/X-SAR radar image data to measure vegetation type, extent, and deforestation; soil moisture content; ocean dynamics; wave and surface wind speeds and directions; volcanism and tectonic activity; soil erosion and desertification; and topography.

The SIR-C/X-SAR antenna structure consisted of three individual antennas: one operating at L-band (23.5-centimeter/9.3-inch wavelength), one at C-band (5.8-centimeter/2.3-inch wavelength), and one at X-band (3-centimeter/1.2-inch wavelength). The SIR-C/X-SAR antenna structure was composed of three leaves, each divided into four subpanels. Weighing a total of more than 10,500 kilograms (23,149 pounds) and measuring 12 meters (39.4 feet) by 4 meters (13.1 feet), it was the most massive piece of hardware ever assembled at NASA's JPL.³⁴⁴

SIR-C, built by JPL and the Ball Communications Systems Division, provided multifrequency, multipolarization radar data. The instrument consisted of several subsystems: the antenna array, the transmitter, the receivers, the data-handling subsystem, and the ground SAR processor. The antenna had two planar arrays, one for L-band and one for C-band. Each array consisted of a uniform grid of dual-polarized microstrip antenna radiators, with each polarization port fed by a separate corporate feed network. The L-band and C-band antennas measured both horizontal and vertical polarizations and used phased-array technology that allowed the direction of the antenna beam to be adjusted electronically.³⁴⁵

³⁴⁴ "What Is SIR-C/X-SAR?" <http://southport.jpl.nasa.gov/desc/SIRCdesc.html> (accessed January 18, 2007).

³⁴⁵ "What Is SIR-C/X-SAR?" <http://southport.jpl.nasa.gov/desc/SIRCdesc.html> (accessed February 2, 2006).

The X-SAR instrument was built by the Dornier and Alenia Spazio companies for DARA and ASI, respectively, and operated at X-band frequency. The X-SAR antenna used a mechanical tilt to change the pointing direction of the beam.

Both SIR-C and X-SAR could be operated as stand-alone radars or together. Roll and yaw maneuvers of the Space Shuttle allowed data to be acquired on either side of the Shuttle ground track. The width of the imaged swath on the ground varied from 15 kilometers to 90 kilometers (9–56 miles) depending on the orientation of the antenna beams and the operational mode. Table 2-108 presents a summary of SIR-C/X-SAR system characteristics.

These missions demonstrated the concept of “supersites,” geographic areas selected by the SIR-C/X/SAR science team for intensive coverage). The team selected 19 supersites and 15 backup supersites. Interdisciplinary studies were conducted at each supersite (see table 2-109). Tropical forests in the Amazon Basin, boreal forests in northern Michigan, and temperate forests in North Carolina provided data relating to the global carbon and hydrologic cycles. Supersites in areas of Brazil, Italy, and the midwestern United States provided data that addressed the hydrologic cycle. Paleoclimate and geologic process studies were focused in arid North Africa, semi-arid areas in the southwest United States, tectonically active areas in the south-central Andes, and the volcanically active Galapagos Islands. Oceanography experiments were focused in the Gulf Stream, the eastern North Atlantic, and the Southern Ocean. Calibration ground equipment was deployed at various supersites, including those in southern Germany, the Netherlands, and Australia.³⁴⁶

³⁴⁶ “SRL Science Mission Overview,” <http://southport.jpl.nasa.gov/science/missiono.html> (accessed February 2, 2006).

The MAPS instrument provided a database of carbon monoxide (CO) concentrations over much of the globe. MAPS measured CO in the lower atmosphere between 2 and 10 miles (3.2–16.1 kilometers) from Earth’s surface. Although not a greenhouse gas, CO is important to researchers because it is produced by human activities and, unlike other gases of interest, such as methane, CO can be detected and measured as it moves through the atmosphere. CO is also significant because it is oxidized by the same airborne hydroxyl radical that cleanses the atmosphere of greenhouse gases. Therefore, by directly measuring and mapping CO distribution, researchers can learn about concentrations of hydroxyl radicals and their distribution in the atmosphere, and provides an estimate of the atmosphere’s ability to cleanse itself. MAPS measurements were correlated with ground and aircraft measurements and other satellite images. The Shuttle crews also provided valuable information about the measurement area using observations and photography acquired during the missions.³⁴⁷

MAPS consisted of a gas correlation infrared radiometer, an optical camera system, and supporting electronics and mechanical mounting and cooling systems. It was carried in the orbiter cargo bay on an MPES. The Shuttle crew activated and deactivated MAPS. All commands during science operations were performed through the MAPS support facilities in the Payload Operations Control Center (POCC) at JSC. During the mission, the MAPS science team monitored downlinked telemetry, and a digital tape recorder within one of the MAPS experiment containers also recorded data.³⁴⁸

³⁴⁷ “Space Radar Laboratory-2 (SRL-2) Pre Launch Mission Operation Report,” Office of Mission to Planet Earth, Report No. U 666-94-68-02, pp. 12–13, NASA History Division folder 11055, Historical Reference Collection, NASA Headquarters, Washington, DC.

³⁴⁸ “Space Radar Laboratory-2 (SRL-2) Prelaunch Mission Operation Report,” pp. 16–17.

The POCC at JSC was staffed by teams from JPL for SIR-C, Germany and Italy for X-SAR, Langley Research Center in support of MAPS, and the Applied Physics Laboratory of Johns Hopkins University for the SRL wave spectra processor.³⁴⁹ During the missions, scientists in the POCC communicated daily with researchers who were part of the “ground truth” teams. The ground teams at several of the supersites repeated simultaneous measurements of vegetation, soil moisture, sea state, snow, and weather conditions during the missions. Data was also collected from aircraft and ships to ensure an accurate interpretation of the radar data taken from space. In addition, the Shuttle astronauts recorded their personal observations of weather and environmental conditions in coordination with SIR-C/X-SAR operations.³⁵⁰

Space Radar Laboratory

SRL-1 was the primary payload on Space Shuttle mission STS-59, launched on April 9, 1994. The first of two Shuttle-based Earth remote sensing missions designed to refine research methods for investigating various Earth-changing processes, SRL-1 gathered data about Earth and the effect of humans on the planet’s carbon, water, and energy cycles. SRL-1 consisted of the SIR-C/X-SAR (the first spaceborne multiparameter radar in the MTPE program) and the MAPS instrument, which had flown twice before. SIR-C/X-SAR was located on a Spacelab pallet in the Shuttle’s payload bay. It was activated by crew members and operated by teams on the ground. (Figure 2-37 shows the location of the X-SAR panels and the SIR-C-band and L-band panels on the payload bay pallet.) Thirteen countries were represented in the project, and 49 PIs and more than 100 scientists coordinated by JPL.

³⁴⁹ “Space Radar Laboratory-1 Pre Launch Mission Operation Report,” NASA Office of Mission to Planet Earth, Report No. Y-666-94-59-01, p. 13, NASA History Division folder 11026, Historical Reference Collection, NASA Headquarters, Washington, DC.

³⁵⁰ “Space Radar Laboratory-2 (SRL-2) Pre Launch Mission Operation Report,” p. 7, NASA History Division folder 11055, Historical Reference Collection, NASA Headquarters, Washington, DC.

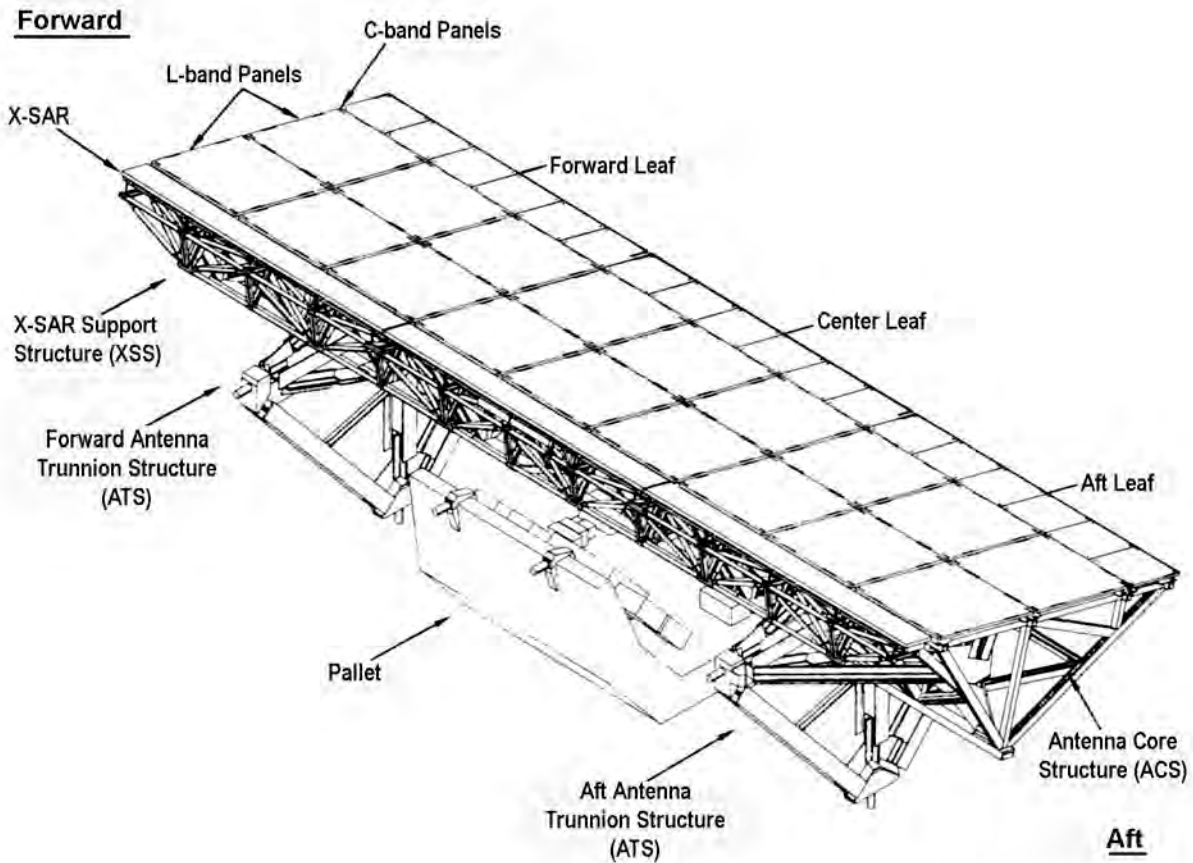

Figure 2-37. The SIR-C and X-SAR located on a Spacelab pallet in the Shuttle's payload bay on STS-59 (STS-59 Press Kit).

The program's objectives were to launch and operate the SIR-C/X-SAR system to obtain research-quality data from terrestrial and oceanographic sites for evaluation of spaceborne Earth sensing radar methodologies and techniques. An additional objective was to launch and operate the MAPS instrument. The SIR-C/X-SAR science objective was to acquire calibrated, high-resolution, research-quality radar data simultaneously using L-, C-, and X-band radars in various polarizations to use in the study of the terrestrial global carbon cycle, the hydrological cycle, climate and geological processes, and ocean circulation and air/sea interactions. The MAPS

science objective was to measure the concentration of CO in the lower atmosphere to use in the study of pollution distribution patterns and atmospheric dynamics.³⁵¹

The SIR-C/X-SAR acquired high-resolution radar data and images of Earth surface features and vegetation cover. More than 400 sites were imaged, including 19 primary observation sites (supersites) in Brazil, Michigan, North Carolina, and central Europe. The total area covered was 25.6 million square miles (~50 million square kilometers).³⁵² Some 65 hours of data were collected.

The MAPS experiment measured and mapped the global distribution and concentration of CO in the troposphere, or lower atmosphere.³⁵³ Data showed a trend of CO concentrations increasing from the Southern Hemisphere toward the Northern Hemisphere.³⁵⁴

SRL-1 acquired the first simultaneous multifrequency (C-, L-, and X-bands), multipolarization, phased-array imaging radar data in space for geoscientific studies of Earth in different seasons. SRL-1 was completely successful in achieving all science objectives. In addition to acquiring high-resolution data at all of the planned sites, the science team adjusted the mission timeline and observed events as they happened on the ground. The SIR-C/X-SAR obtained data of severe flooding inundating the midwestern United States and Germany, as well as three different views

³⁵¹ “Space Radar Laboratory-1 Pre Launch Mission Operation Report,” p. 4, NASA History Division folder 11026, Historical Reference Collection, NASA Headquarters, Washington, DC.

³⁵² “SIR-C/X-SAR Flight 1 Statistics,” JPL Fact Sheet, http://southport.jpl.nasa.gov/sir-c/getting_data/missions_stats.html (accessed 7 December 2005). Also e-mails from Bruce Chapman, JPL, December 7, 2005.

³⁵³ “Space Radar Laboratory-1 Pre Launch Mission Operation Report”, NASA History Division folder 11026, Historical Reference Collection, NASA Headquarters, Washington, DC.

³⁵⁴ “Space Radar Laboratory-2 (SRL-2) Pre Launch Mission Operation Report,” p. 12, NASA History Division folder 11055, Historical Reference Collection, NASA Headquarters, Washington, DC.

of tropical cyclone Odille as it formed in the Pacific Ocean. Scientists also acquired a series of radar images over Canada documenting the annual spring thaw of snow, ice, and soil.³⁵⁵

Space Radar Laboratory

SRL-2 flew on Space Shuttle mission STS-68, which launched on September 30, 1994. The SRL-2 payload was identical to SRL-1, consisting of the SIR-C/X-SAR and the MAPS experiments mounted in *Endeavour*'s payload bay. Flying the SRL-1 in mid-April and SRL-2 at the end of September allowed investigators to compare seasonal observations from the two flights. The mission tested the ability of SRL-2's imaging radar to distinguish between changes caused by human-induced phenomena, such as oil spills, and those caused by naturally occurring events. Using interferometry, SAR scientists demonstrated their ability to measure the topographic surface of Earth and detect changes as small as a few centimeters.

The SRL-2 mission demonstrated the orbiter's maneuvering capability as the crew piloted *Endeavour* to within 30 feet (9.1 meters) of where it had flown during the first SRL mission. The total area covered on this mission was 32 million square miles (~83 million square kilometers).³⁵⁶ Using the SIR-C/X-SAR, the crew imaged an erupting volcano in Russia and the islands of Japan after an earthquake. The MAPS experiment revealed high concentrations of CO over the tropics and Southern Hemisphere and large sources of air pollution in the lower atmosphere (3–10 kilometers/1.9–6.2 miles above Earth's surface) over southern Africa, the Indonesian Islands, and the grasslands and savannas in central South America.³⁵⁷

³⁵⁵ "Space Radar Laboratory-2 (SRL-2) Pre Launch Mission Operation Report," p. 7 (NASA History. Office folder 11055).

³⁵⁶ "SIR-C/X Flight 2 Statistics," http://southport.jpl.nasa.gov/sir-c/getting_data/missions_stats.html (accessed December 7, 2005).

³⁵⁷ "Measurement of Air Pollution from Satellites (MAPS)—Understanding the Chemistry of the Atmosphere," Fact Sheet, FS-1996-09-19-LaRC, September 19, 1996, <http://www.nasa.gov/centers/langley/news/factsheets/MAPS.html> (accessed February 2, 2006).

Lidar In-space Technology Experiment (LITE)

LITE was a three-wavelength backscatter lidar developed by NASA's Langley Research Center to fly on the Space Shuttle.³⁵⁸ It flew on *Discovery* in September 1994 as part of the STS-64 mission. The goals of the mission were to:

- Validate key lidar technologies for spaceborne applications
- Explore the applications of space lidar
- Gain operational experience to benefit the development of future systems on free-flying satellite platforms

This technology experiment used laser optical radar for the first time to perform atmospheric research as part of NASA's MTPE program. It operated for 53 hours and yielded more than 43 hours (40 gigabytes) of high-rate data covering 1.4 million kilometers (0.9 million miles) of ground track. Sixty-five groups from 20 countries made validation measurements with ground-based and aircraft instruments to verify the LITE data.

LITE was designed with the capability to measure the vertical profile of certain atmospheric parameters, including cloud top height, planetary boundary layer (PBL) height, tropospheric and stratospheric aerosols, temperature, and density. To obtain these measurements, LITE emitted laser energy into the atmosphere and measured the return signals scattered from the atmospheric constituents³⁵⁹. The data provided the first highly detailed global view of the vertical, multilayer structure of cloud and aerosol from Earth's surface through the middle stratosphere; the first global observations of PBL height; and sensitive observations of the distribution of desert dust,

³⁵⁸ LIDAR stands for light detection and ranging.

³⁵⁹ "SAREX Fact Sheet—CTS-64," <http://www.arrl.org/files/sarex/sts-64/sts64fct.txt> (accessed September 24, 2007).

smoke, and other aerosols.³⁶⁰ Unprecedented views were obtained of storm systems, dust clouds, pollutants, burning forests, and surface reflectance. Sites studied included the atmosphere above northern Europe, Indonesia, the South Pacific, Russia, and Africa.

LITE was initiated in 1985 to demonstrate operation of a lidar in space. It was decided that the most convincing demonstration would be within the context of actual atmospheric investigations, and a LITE Science Steering Group was formed in 1988 to develop instrument performance requirements, guide development of the LITE experiment plan, and use the scientific data provided by the instrument. Technology issues included laser design and operation in space, thermal management, alignment and control, and autonomous system operation. Part of the technology objective was to validate the thermal/mechanical models used for design and performance prediction, as well as fabrication and test procedures.

The LITE instrument was designed to take measurements in the stratosphere between 25 kilometers (15.5 miles) and 40 kilometers (24.9 miles) altitude. Additionally, limited measurements of the surface return strength over both land and ocean were collected to explore retrievals of surface properties. Most surface return data were collected at near-nadir angles; however, several landmark track maneuvers were also performed by *Discovery* to measure the angular dependence of the sea surface return. Table 2-110 lists the primary geophysical parameters measured by LITE.

NASA Mission Control in Houston had primary command of LITE. All commands went to the instrument controller, which parsed the commands and relayed them to the aft optics or boresight

³⁶⁰ “LITE—A View from Space,” <http://www-lite.larc.nasa.gov/> (accessed January 24, 2007).

assembly subsystems if required. Instrument-level commands were executed by the instrument controller. The LITE instrument command set was very versatile and included more than 200 commands to control every facet of instrument operation. There were five predefined operating modes: standby, day datatake, night datatake, autonomous, and built-in test system (BITS).³⁶¹

The LITE instrument was mounted onto a standard Spacelab pallet inside the open payload bay of Space Shuttle *Discovery*, which orbited with the bay pointed toward Earth and at approximately 5 degrees off-nadir.³⁶² The instrument was integrated with the pallet avionics and a pump package connected to the Shuttle cooling system and mounted on an orthogrid platform attached to the pallet by 52 struts. *Discovery*, orbiting at an inclination of 57 degrees to the equator, passed over approximately 25,000 miles (40,234 kilometers) of Earth's surface with each revolution. It flew at a relatively low altitude of about 260 kilometers (160 miles) for orbits 1–90 so that each downward-pointing lidar pulse would be dispersed as little as possible as it passed through the atmosphere and at an altitude of approximately 240 kilometers (149 miles) for orbits 90–150 to optimize landing opportunities. The orbital velocity, laser pulse rate, and beam divergence produced a series of laser footprints on the ground spaced by 740 meters (2,428 feet), center to center.³⁶³

Instrument activation began soon after the payload bay doors were opened, about 3 hours after launch. The instrument was ready to operate for the first scheduled lidar operations 5.5 hours after launch. During the mission, there were 10 datatakes ranging from about 3.5 hours to 5

³⁶¹ “LITE Overview,” http://www-lite.larc.nasa.gov/n_overview.html (accessed January 24, 2007).

³⁶² Nadir was defined to be along the geodetic local vertical, which was the line perpendicular to the geoid and passing through the orbiter center of gravity.

³⁶³ “Space Shuttle Mission STS-64 Press Kit,” September 1994, p. 16, http://www.jsc.nasa.gov/history/shuttle_pk/pk/Flight_064_STS-064_Press_Kit.pdf (accessed February 6, 2007). Also “LITE Instrument,” http://www-lite.larc.nasa.gov/n_instrument.html (accessed January 24, 2007).

hours in length and 32 short snapshots of 15–40 minutes each. When it was not lasing, the system was put into standby mode. Each datatake covered roughly three orbits and was located in the timeline to accommodate a mix of correlative measurement activities and studies of regional phenomena. The snapshots were focused on specific regional phenomena or correlative sites.

At each lidar pulse, a photon stream traveled from the lidar through the atmosphere to Earth's surface. The path along this photon stream was referred to as the LITE pointing vector. The intersection of the LITE pointing vector with the surface of the geoid was used to define the geodetic latitude and longitude of the LITE footprint relative to a location on Earth's surface.³⁶⁴

During the mission, the instrument was powered continuously for more than 220 hours, with 53 hours of lasing. In spite of a problem with the High Data Rate Recorder discovered on the first day of the mission, the operations team was able to downlink and archive in real time about 80 percent of the high-rate data that were generated. Because the low-rate data stream was backed up on a different Shuttle recorder during the TDRSS loss-of-signal, 100 percent of the instrument status data and quick-look science data were obtained. A total of 43.5 hours of high-rate profiles and 53 hours of quick-look profiles were acquired. The ground tracks for the low-rate data provided good coverage between 57°N and 57°S. There was a gap in the high-rate coverage between 60°E and 85°E due to the “zone of exclusion,” where neither TDRSS satellite was in view.

³⁶⁴ “LITE Measurement Geometry,” http://www-lite.larc.nasa.gov/level1doc/the_geometry_tmp.html#orb_char (accessed January 24, 2007).

To verify the accuracy of the measurements made by LITE, a worldwide correlative measurements program was organized by the LITE Science Steering Group. This effort used airborne sensors and an extensive worldwide network of ground-based lidars. More than 60 ground-based lidars, located in North and South America, Europe, Asia, and Australia, participated in the program. Airborne instruments were particularly valuable because of their ability to fly directly over the Shuttle ground track and to make observations in remote regions. NASA operated aircraft in the Atlantic and eastern Caribbean, extending as far south as Cape Town, South Africa. The Canadian Atmospheric Environment Services operated a Convair 580 aircraft near the coast of California, and two aircraft were operated in northern Europe under the aegis of ESA. All aircraft carried at least one lidar, and several carried radiometers and in situ sensors.³⁶⁵

Spacelab-Mir Mission

STS-71, launched from Kennedy Space Center on June 27, 1995, was the first in a series of Space Shuttle missions to dock with the Russian space station *Mir*.³⁶⁶ The mission included joint scientific investigations, called the Shuttle-Mir Science Program, that were carried out inside the Spacelab module in Space Shuttle *Atlantis*'s cargo bay. The science program developed from agreements made in 1992 between the U.S. and Russian governments to cooperate in human spaceflight. It used the Space Shuttle, Spacelab, and *Mir* to conduct joint research activities in space.³⁶⁷ *Spacelab-Mir* (SL-M) followed the end of the Mir-18 mission, during which the crew—an American astronaut and two Russian cosmonauts—had remained on *Mir* for 90 days,

³⁶⁵ Source: "LITE Overview," http://www-lite.larc.nasa.gov/n_overview.html (accessed January 24, 2007).

³⁶⁶ Details of the docking can be found in chapter 3 of volume VII of the *NASA Historical Data Book, 1989–1998*.

³⁶⁷ "Spacelab-Mir," brochure, pp. 3–4, NASA History Division folder 008895, Historical Reference Collection, NASA Headquarters, Washington, DC.

participating in long-duration life-sciences experiments as well as other activities planned by NASA and the Russian space agency. The joint investigations on *Mir* and STS-71 provided information on how crews react to, benefit from, and operate in the space environment—all important to the design and development of space stations. They provided long-duration science-gathering opportunities, as well as the perspectives and expertise of scientists from different countries and cultures, continued research, increased the number of subjects, and expanded the database on space-related science disciplines. The experiments advanced our understanding of factors involved in Earth-based conditions, such as anemia, hypertension, osteoporosis, kidney stones, and immune-system deficiencies. The program also provided researchers an early opportunity to learn how to increase productivity on the future International Space Station.³⁶⁸

Specifically, SL-M included investigations in seven medical and scientific disciplines: human metabolism; the cardiovascular and pulmonary system; the neurosensory system; hygiene, sanitation, and radiation; microgravity; behavior and performance; and fundamental biology. The science payload consisted of 28 experiments that took advantage of the cargo bay's microgravity environment. The United States and Russia each supplied lead scientists and investigators for every experiment. In addition, many experiments that had begun during the Mir-18 mission continued on SL-M. Researchers increased their knowledge of the effects of spaceflight, especially the physiological changes the human body experiences in weightlessness.³⁶⁹ STS-71 also carried several hundred protein samples frozen in a thermos bottle-like vacuum jacket, or dewar, to the *Mir*. After the samples were thawed, the proteins crystallized until the dewar was

³⁶⁸ "Spacelab-Mir," brochure., p. 6, (NASA History. Office folder 008895).

³⁶⁹ Roger D. Launius, *Space Station: Base Camps to the Stars* (Washington and London: Smithsonian Institution, 2003), p. 163.

retrieved by the STS-74 crew.³⁷⁰ Data and samples collected during Mir-18 were also transferred from *Mir* to *Atlantis* for return to Earth. Additionally, 11 experiments remained on *Mir* to be carried out by the Mir-19 crew.³⁷¹ Table 2-111 lists investigations performed on this mission.

Life and Microgravity Spacelab (LMS)

LMS was an ambitious scientific mission that planned, integrated, and performed a number of spaceflight experiments in half the time normally required for similar missions. The diversity of the experiments, the international participation, and the shortened time for performing the mission provided lessons applicable to scientific operations for the upcoming International Space Station. The mission objective was to conduct life and materials scienceS investigations that required the unique low-gravity environment created inside an orbiting space laboratory free-falling around Earth.³⁷²

LMS was manifested for STS-78 in September 1994 and flew aboard the Space Shuttle *Columbia* from June 20 through July 7, 1996. The planning and integration of the mission were performed in 21 months. This was the shortest planning period for any such Spacelab mission, which typically took three to four years. As a result, the payload costs were approximately half those of other Spacelab missions. At the time, the flight was the longest-duration Space Shuttle flight in the program's history. The mission was planned for 16 days on orbit but was extended to 17 days to increase its scientific return.

³⁷⁰ "Space Shuttle Mission STS-71 Press Kit," June 1995, pp. 26–28, http://www.jsc.nasa.gov/history/shuttle_pk/pk/Flight_069_STS-071_Press_Kit.pdf (accessed February 2, 2006).

³⁷¹ "STS-71: First Docking, June 27–July 7, 1995," in Clay Morgan, *Shuttle-Mir: The United States and Russia Share History's Highest Stage* (Washington, DC: NASA Special Publication-4225, 2001), <http://history.nasa.gov/SP-4225/sts71/sts-71.htm> (accessed February 8, 2006).

³⁷² "The Life and Microgravity Spacelab Mission," foldout.

The mission was international in scope, and five space agencies took part. In addition to NASA, investigators from the European, French, Italian, and Canadian space agencies were involved. Research scientists from 10 countries worked together on the payload, which made use of the Spacelab long module. NASA astronauts were joined by crew members from Canada and France, and their alternates added Italy and Spain to the mix. The LMS payload experiments were monitored and commanded by investigator teams from sites around the world. The NASA sites included MSFC, Lewis Research Center, JSC, and KSC. The European sites involved were in Toulouse, France; Milan and Naples, Italy; and Brussels, Belgium.

The international team developed 41 experiments to study the effects of gravity on the human body, the development of plants and animals, the processing of protein crystals and metallic alloys, and fluid behavior. Data from three accelerometers supported these investigations.

The microgravity science experiments included interfacial fluid physics studies of thermocapillary flow and electrohydrodynamics performed in the Bubble, Drop, and Particle Unit (BDPU). Also the most extensive set of microgravity experiments to date regarding the morphology of semiconductors and metal alloys was performed in the Advanced Gradient Heating Facility. These materials were formed under different processing conditions to achieve a spectrum of morphologies, including single crystals, equiaxed dendrites, and columnar dendrites. The final microgravity experiments were performed in the Advanced Protein Crystallization Facility and consisted of protein crystal growth investigations that included inflight, in situ observations of growth, as well as postflight crystallography studies. The various life-scienceS investigations included studies on lignin formation in the Plant Growth Facility, the role of

corticosteroids in bone loss (performed on rats in the Animal Enclosure Module), and the development of medaka fish eggs (performed in the Space Tissue Loss Module). In addition, a number of human physiology experiments involving musculoskeletal studies were performed on the Torque Velocity Dynamometer (TVD). Other human physiology investigations included neuroscience studies of torso rotation and canal and otolith function, metabolic experiments on calcium and caloric balance, behavior and performance studies of circadian rhythms and cognitive performance, and a study on pulmonary function. Taken together, these investigations gave the most complete characterization and understanding of human response and adaptation to spaceflight performed to date.³⁷³ A list of investigations is given in table 2-112.

MSFC was the lead center responsible for the LMS science payload. It provided the mission manager, mission scientist, Spacelab Mission Operations Control Center, and Payload Operations Control Center.³⁷⁴

Microgravity Science Laboratory (MSL)

The MSL mission was designed to bridge the gap between the Shuttle-based approach to integrating experiments on Spacelab missions and space station processes. The space station would use new types of racks and install and connect them to the various power, data, and supply systems from the front rather than from the rear as in Spacelab missions. This new process would make it easier and more cost-effective to upgrade and replace equipment. The MSL provided researchers an opportunity to test the new racks, experiment hardware, and procedures before

³⁷³ The information in the preceding paragraphs was taken largely from J. P. Downey, compiler, *Life and Microgravity Spacelab (LMS) Final Report*, February 1998, NASA/Contractor Publication CP-1998-206960, pp. iii–iv.

³⁷⁴ “The Life and Microgravity Spacelab Mission,” p. 2.

building the space station. MSL also brought together international academic, industrial, and governmental partners. The laboratory used new and existing facilities to expand previous research and serve as a testbed for new procedures designed to place scientific payloads into orbit in a shorter amount of time than was previously possible.³⁷⁵

Microgravity Science Laboratory

MSL-1 was launched on April 4, 1997, on STS-83. Mission managers cut the flight short after four days because of concerns about one of the three fuel cells that provided electricity and water to the orbiter. A decision was made after it landed to reflly the mission in its entirety on STS-94. STS-83 was the first mission to end early since STS-44 in 1991. Only the Thermophysical Properties of Undercooled Metallic Melts, Liquid-Phase Sintering II, Laminar Soot Processes, and Structure of Flame Balls at Low Lewis-number (SOFBALL) experiments were carried out before the mission ended.

Microgravity Science Laboratory-1 Reflight: STS-94

Following a modified processing session at Kennedy Space Center, Space Shuttle *Columbia* flew again on July 1, 1997, completing the STS-83 MSL flight shortened by mission managers because of a fuel cell problem. The reflight of the MSL payload was designated STS-94 and involved the same vehicle, crew, and experiments as originally planned earlier in the year. It was the first time a payload remained in the orbiter between flights.³⁷⁶

³⁷⁵ “NASA’s Microgravity Science Laboratory: Illuminating the Future,” NASA Marshall Space Flight Center Payload Projects Office, NASA History Division folder 17676, Historical Reference Collection, NASA Headquarters, Washington, DC. Also at <http://liftoff.msfc.nasa.gov/shuttle/msl/brochure.pdf> (accessed February 7, 2006).

³⁷⁶ “Columbia Passes Milestone Toward Quick Reflight, *NASA News* Release 97-122, June 4, 1997, <ftp://ftp.hq.nasa.gov/pub/pao/pressrel/1997/97-122.txt> (accessed February 7, 2006).

The STS-94 MSL-1 crew remained in orbit more than two weeks conducting a variety of experiments in the fields of combustion, biotechnology, and materials processing to examine how various materials and liquids change and behave in the weightless environment of space.³⁷⁷

The crew maintained 24-hour/two-shift operations. Using the Spacelab module as a testbed, crew members tested some of the hardware, facilities, and procedures that would be used on the International Space Station. Scientists from NASA, ESA, the German space agency, and NASDA contributed the 25 primary experiments, 4 glovebox investigations, and 4 accelerometer studies. A record number of commands—more than 35,000—were sent from the Spacelab Mission Operations Control Center at Marshall Space Flight Center to the orbiting laboratory.

The STS-94 mission flew some new experiment facilities. One new component was the “EXpedite the PROcessing of Experiments to the Space Station” (EXPRESS) rack. The EXPRESS rack was designed for quick and easy installation of experiment and facility hardware on orbit. EXPRESS was a Space Station International Standard Payload Rack being flown as a precursor payload. It provided standard and simple interfaces to payloads, thereby simplifying the integration process of payloads into the rack. The rack accommodated payloads compatible with the Space Shuttle middeck, SPACEHAB, and Standard Interface Rack drawers.³⁷⁸ The rack replaced a Spacelab double rack, and special hardware provided the same structural and resource connections the rack would have on the space station. Two payloads—the Physics of Hard

³⁷⁷ “Space Shuttle Mission STS-94 Press Kit,” p. 6, http://www.jsc.nasa.gov/history/shuttle_pk/pk/Flight_085_STS-094_Press_Kit.pdf (accessed February 5, 2006).

³⁷⁸ “NASA’s Microgravity Science Laboratory: Illuminating the Future,” Experiment Fact Sheet D, “EXPRESS Rack,” NASA Marshall Space Flight Center Payload Projects Office, NASA History Division folder 17676, Historical Reference Collection, NASA Headquarters, Washington, DC. Also at <http://liftoff.msfc.nasa.gov/shuttle/msl/brochure.pdf> (accessed February 7, 2006).

Spheres experiment and the Astro/Plant Generic Bioprocessing Apparatus experiment—were flown to check the design, development, and adaptation of the EXPRESS rack hardware.³⁷⁹

Another advanced operational concept again being tested on STS-94 was the use of “expert” software systems. Designed to reduce the number of people required to support International Space Station operations, the software packages would help human controllers provide rapid response to changes in mission operations.³⁸⁰

The Middeck Glovebox (MGBX), developed by Marshall, enabled crew members to handle, transfer, and manipulate experiment hardware and materials that were not approved for use in the open Spacelab. The original Spacelab Glovebox, provided by ESA, was part of the payload on USML-1 and -2 missions. The new facility, developed in 1995, was equipped with a video recording system that provided three simultaneous views of MGBX investigations and recorded five channels of digital and analog data. The new facility had a larger working area and improved lighting. It also supplied more status information on environmental factors, such as humidity.³⁸¹

The Large Isothermal Furnace (LIF) was a vacuum-heating furnace designed to heat large samples uniformly. First used by three investigations on the Spacelab J mission, the LIF had a maximum temperature of 1,600°C (2,912°F) and could cool a sample rapidly through the use of

³⁷⁹ “Space Shuttle Mission STS-94 Press Kit,” p. 16, http://www.jsc.nasa.gov/history/shuttle_pk/pk/Flight_085_STS-094_Press_Kit.pdf (accessed February 5, 2006).

³⁸⁰ “Space Shuttle Mission STS-94 Press Kit,” p. 6.

³⁸¹ “NASA’s Microgravity Science Laboratory: Illuminating the Future,” Fact Sheet G, “Middeck Glovebox,” NASA Marshall Space Flight Center Payload Projects Office, NASA History Division folder 17676, Historical Reference Collection, NASA Headquarters, Washington, DC. Also at <http://liftoff.msfc.nasa.gov/shuttle/msl/brochure.pdf> (accessed February 7, 2006).

a helium purge. For MSL-1, the furnace was modified to allow ground commanding of the heating and cooling processes so that investigators could make real-time changes to enhance science operations.

The Combustion Module-1 (CM-1) was developed by NASA as a way to test hardware and experiment approaches on Spacelab in preparation for research on the International Space Station. The key concept CM-1 demonstrated was the ability to accommodate a variety of combustion experiments by using experiment-unique chamber inserts called Experiment Mounting Structures (EMSs). Each investigator's EMS was installed in the combustion chamber on orbit. CM-1 required two Spacelab racks (one double and one single rack) with a combined weight of more than 1,600 pounds (730 kilograms). At the heart of CM-1, the double rack housed the Experiment Package (EP), which contained the 90-liter combustion chamber, the gas chromatograph, and seven cameras. The EP chamber slide rails and quick disconnects enabled the crew to insert and connect the EMS for each investigation. Also housed in the double rack were a variety of experiment computers and support equipment.

TEMPUS, an electromagnetic levitation facility allowing containerless processing of metallic samples in microgravity, first flew on the IML-2 Spacelab mission. During the MSL-1 mission, scientists performed refined IML-2 experiments, studying various thermodynamic and kinetic properties of up to 22 samples. An electromagnetic levitation facility was planned for the space station, and the knowledge provided by these Spacelab operations would allow scientists to improve facility design, refine experiment techniques, and verify initial results. Table 2-113 lists MSL-1 investigations.

Neurolab

The idea for Neurolab began on July 17, 1990, when President George Bush signed a proclamation declaring the 1990s the “Decade of the Brain” to recognize advances in our understanding of the basic structure and function of the brain.³⁸² NASA proposed the Neurolab mission as its contribution to this mandate. In 1991, meetings began with the National Institutes of Health (NIH), the National Science Foundation, and DOD, as well as several international space agencies. NASA also held a series of meetings with the neuroscience community to identify critical issues relating to gravity’s effect on the nervous system. The resulting announcement of opportunity for Neurolab in 1993 drew 172 proposals from scientists worldwide. International agencies, including CSA, CNES, DLR, ESA, and NASDA, partnered with NASA from the beginning in planning a space mission dedicated to neuroscience and establishing criteria for selecting proposals. After a peer review (managed by NIH), NASA selected 32 proposals, 26 of which flew on STS-90.³⁸³

The mission was a joint venture of six space agencies and seven U.S. research agencies. The agencies participating in this mission included the National Science Foundation, the Office of Naval Research, six institutes of the NIH, the ESA, and the space agencies of Canada, France, Germany, and Japan. The international agencies provided flight and ground hardware for Neurolab experiments and supported investigations from their respective countries.

³⁸² “Project on the Decade of the Brain,” Presidential Proclamation 6158, <http://www.loc.gov/loc/brain/proclaim.html> (accessed February 7, 2006).

³⁸³ “Space Shuttle Mission STS-90 Press Kit,” April 1998, p.5, http://www.jsc.nasa.gov/history/shuttle_pk/pk/Flight_090_STS-090_Press_Kit.pdf (accessed February 7, 2006).

The Neurolab mission launched on STS-90 on April 17, 1998, and spent almost 16 days in space. The prime mission objective was to conduct research that would contribute to a better understanding of the human nervous system, which faces major challenges in microgravity. Neurolab investigations studied the adaptation of the vestibular system and space adaptation syndrome, the adaptation of the central nervous system and the pathways that control the ability to sense location in the absence of gravity, and the effect of microgravity on the developing nervous system.³⁸⁴

Neurolab investigated five major research areas: the balance system; sensory integration and navigation; nervous system development in weightlessness; blood pressure control; and circadian rhythms, sleep, and respiration. Crew members served as both experiment subjects and operators and worked with a wide array of biomedical instrumentation, including some instruments and devices developed especially for the mission. Investigations were also carried out on animals—rats, mice, crickets, snails, and two kinds of fish.³⁸⁵ Figure 2-38 shows an oyster toadfish like those used on the mission. Table 2-114 lists Neurolab investigations.

³⁸⁴ “STS-90 Shuttle Mission Archive,” http://www.nasa.gov/mission_pages/shuttle/shuttlemissions/archives/sts-90.html (accessed May 23, 2007).

³⁸⁵ “Space Shuttle Mission STS-90 Press Kit,” April 1998, p. 15.



Figure 2-38. An oyster toadfish like those that are part of the Neurolab payload on Space Shuttle mission STS-90 is shown in its holding tank in the Space Station Processing Facility. This fish is an excellent model for looking at vestibular function because the architecture of its inner and middle ear is similar to those of mammals with respect to the vestibular apparatus (NASA photo KSC-98PC-0415).

Shuttle Solar Backscatter Ultraviolet (SSBUV) Experiment

The Shuttle Solar Backscatter Ultraviolet (SSBUV) experiment, an element of the MTPE program, measured ozone concentrations and provided calibrations from the Space Shuttle to check data from NASA and NOAA free-flying satellite ozone instruments. This was done to ensure the most accurate readings possible when detecting atmospheric ozone. Space Shuttle *Atlantis* carried the first SSBUV on STS-34 in 1989. It subsequently flew on STS-41, STS-43, STS-45, STS-62, STS-66, and STS-72. The instrument was developed at Goddard.

The SSBUV measured ozone concentrations by comparing solar ultraviolet radiation with radiation scattered back from Earth's atmosphere. It used the Space Shuttle's orbital flight path to assess performance on several other ozone-measuring SBUV instruments aboard NOAA polar-orbiting satellites, Nimbus-7, the Russian Meteor-3/TOMS satellite, and UARS by directly comparing the observations as the Shuttle and satellites passed over the same Earth location within an hour.³⁸⁶ These orbital coincidences could occur 17 times a day.

The instrument's value lay in its ability to provide highly accurate ozone measurements. The SSBUV underwent rigorous calibration to laboratory standards before, during, and after flight to ensure its accuracy. This rigorous calibration had been maintained since the beginning of the SSBUV flight series. Consequently, scientists could determine the reliability of ozone data gathered by other satellite instruments.

Its impact on NASA's ability to detect ozone trends accurately was realized after approximately four flights. Data from the first flight with an earlier satellite already had been used to estimate ozone trends in the upper stratosphere beginning in 1980. These results showed a depletion of about 8 percent over 10 years, which was consistent with predictions of ozone depletion.

Data from the SSBUV's first three Shuttle flights in 1989, 1990, and 1991 were used to update the calibration of the NOAA-11 SBUV/2 ozone instrument, which had been orbiting since late 1988. The NOAA ozone data were reprocessed with a refined algorithm and new calibration factors based on SSBUV and SBUV/2 inflight calibration data. The reprocessing covered the

³⁸⁶ SBUV instruments on board NOAA satellites estimated the amount and height distribution of ozone in the upper atmosphere by measuring the incident solar ultraviolet radiation and ultraviolet radiation backscattered from Earth's atmosphere.

years of 1989–1993. The reprocessed data were checked against ground-based ozone observations, and the comparisons showed very good agreement. There was also excellent consistency between the refined NOAA-11 SBUV/2 data and the Nimbus-7 SBUV/TOMS dataset, which went back to 1978. The combined 15-year dataset represented an excellent resource for ozone climate and trend studies. The SSBUV detected and verified a significant decrease in the amounts of total Northern Hemisphere ozone between the STS-45/ATLAS-1 (March 1992) and STS-56/ATLAS-2 (March 1993) missions. The depletion was also detected simultaneously by satellites and ground-based observations. Indications were that total ozone decreased during the same period on the order of 10–15 percent at mid-latitudes in the Northern Hemisphere. Scientists believed that this significant depletion resulted from the combined residual effects of Mt. Pinatubo aerosols in the stratosphere and cold stratosphere temperatures during the winter of 1992–1993.

On STS-66, the SSBUV was comanifested with the ATLAS-3 payload, which carried a complement of atmospheric science experiments. UARS instruments also measured ozone. Simultaneous measurements by the SSBUV, ATLAS, and UARS instruments provided researchers a unique opportunity to connect the detailed observations of the physics and chemistry of the stratosphere made by UARS with the ongoing NOAA SBUV ozone observations. These datasets could be used as a baseline for detecting long-term changes in the stratosphere.

The SSBUV instrument and its flight-support electronics, power, data, and command systems were mounted in the Space Shuttle's payload bay in two flight canisters that together weighed

900 pounds (410 kilograms). The Instrument Canister held the SSBUV instrument, its aspect sensors, and an inflight calibration system. Once in orbit, a motorized door assembly opened the canister, allowing the SSBUV to view the Sun and Earth. The canister closed, providing contamination protection while the SSBUV performed inflight calibrations. The Support Canister contained the avionics, including the power, data, and command systems. SSBUV obtained power from the Space Shuttle and received real-time ground commands and data acquisition. This assured enhanced SSBUV data-gathering capabilities and its ability to coordinate measurements with the ATLAS and UARS instruments. The SSBUV commands were sent from a Payload Operations Control Center at GSFC, and its data was received at GSFC and MSFC.³⁸⁷

Wake Shield Facility (WSF)

The WSF was a 12-foot (3.7-meter)-diameter stainless-steel, parabolic-shaped platform that included a communications and avionics system, solar cells and batteries, and a propulsion thruster. Launched from the Space Shuttle, it created a unique “ultravacuum” environment in its wake by a combination of pumping speeds and vacuum levels thousands of times greater than the best vacuum chambers on Earth. Built for eventual long-term autonomous operation, the WSF supported all of the processing and characterization instrumentation required for advanced molecular and chemical beam epitaxy materials processing. It was designed, built, and managed by the Space Vacuum Epitaxy Center (SVEC), a NASA Center for the Commercial Development of Space (CCDS) based at the University of Houston in Texas for the development of space-based manufacturing of thin-film materials.³⁸⁸

³⁸⁷ “Shuttle Solar Backscatter Ultraviolet (SSBUV) Instrument,” NASA Facts Online, NASA Goddard Space Flight Center, http://www.gsfc.nasa.gov/gsfcservice/gallery/fact_sheets/earthsci/ssbuv.htm (accessed January 23, 2006).

³⁸⁸ “Wake Shield Facility Program,” <http://www.svec.uh.edu/wsfp.html> (accessed February 7, 2007).

Program Overview

The space ultravacuum concept was first described at NASA in the 1970s, but no need was identified at the time for its use. Later interest by scientists and corporate researchers in epitaxial thin-film growth encouraged the use of space to create the ultravacuum as an environment in which to grow better thin films.

Recognizing this scientific opportunity as a new economic opportunity, SVEC formed a consortium of interested industries, academic institutions, and government laboratories in 1987 to use the LEO vacuum environment for thin-film growth. In 1989, SVEC partnered with its industry members (led by Space Industries, Inc.) and JSC to build the WSF.³⁸⁹

Before 1989, preliminary studies indicated that the WSF should be a disk or shield about 12–14 feet (3.7–4.3 meters) in diameter that would be deployed from the Shuttle payload bay on the Shuttle robot arm. The WSF hardware development program was soon projected to be complex, time-intensive, and quite costly, and NASA and SVEC mutually decided that a less expensive and time-consuming approach was needed. Consequently, using a fast-track, low-cost approach, commercial off-the-shelf components, and protoflight hardware, the developers moved the first WSF from the drawing board to orbit in less than 60 months for less than \$15 million. This was approximately half the time and less than one-sixth the cost required under a traditional approach to an aerospace hardware development program.³⁹⁰

³⁸⁹ “Space Shuttle Mission STS-60 Press Kit,” February 1994, pp. 16–17, http://www.jsc.nasa.gov/history/shuttle_pk/pk/Flight_060_STS-060_Press_Kit.pdf (accessed February 9, 2006).

³⁹⁰ “Wake Shield Facility Program,” Space Vacuum Epitaxy Center, University of Houston, <http://www.svec.uh.edu/wsf.html> (accessed February 9, 2006).

The primary objectives of the first WSF mission were outlined by SVEC in March 1989. They included characterization of 1) the ultravacuum environment generated by the WSF in low-Earth-orbit space and the flow field around the WSF, and 2) molecular beam epitaxy (the growth of a thin film of the compound gallium arsenide [GaAs]). Both of these primary objectives would be major firsts in space science and technology.³⁹¹

The first two flights of the WSF, in February 1994 and September 1995, produced the first characterizations of vacuum wake formation and epitaxial growth in that wake vacuum of record-purity GaAs and aluminum gallium arsenide (AlGaAs) thin films. In November 1996, WSF-3 continued experiments in advanced thin films for various applications, including high-speed transistors, lasers, and solar cells, by growing material for device fabrication.

The WSF also served as a spaceborne laboratory for exposure and microgravity experiments and as a test bed for instrument development. The three WSF flights carried 25 cooperative payloads to orbit, taking advantage of the WSF's Free Flyer enhanced atomic oxygen flux, a true microgravity environment resulting from momentum bias attitude control, and interactive "Smart Cans" based on NASA's GAS canisters.

Subsequently, the WSF program focused on demonstrating commercial viability and looked to significant commercial investment for future flights. WSF system enhancements were under way and an integration and test schedule was approved for WSF-4 when NASA's funding ran out at the end of 1997. In May 1998, however, SVEC granted an exclusive license to SPACEHAB, Inc., to market, manage, and operate the WSF. This preserved the WSF program and created a

³⁹¹ "Space Shuttle Mission STS-60 Press Kit," February 1994, p. 16.

partnership that combined commercial aerospace marketing knowledge and internationally recognized scientific research.³⁹²

Hardware Description

The WSF consisted of a Shuttle Cross Bay Carrier (SCBC) and a Free Flyer. The SCBC remained in the Shuttle and had a latch system holding the Free Flyer to the Carrier. The Shuttle Remote Manipulator System was attached to the Free Flyer for deployment and free flight in space. The SCBC had an extended-range, stand-alone radio-frequency communications system that let the WSF seem like a payload attached to the Shuttle's systems, even when the Free Flyer was at its stationkeeping distance of 40 nautical miles (74 kilometers) from the Shuttle.

The Free Flyer was a fully equipped spacecraft with cold gas propulsion for separation from the Shuttle and a momentum bias attitude control system. Forty-five kilowatt-hours of energy, stored in silver-zinc batteries, were available to power the thin-film growth cells, substrate heaters, process controllers, and an array of characterization devices. Weighing approximately 9,000 pounds (4,082 kilograms; the Free Flyer alone was 4,000 pounds/1,814 kilograms), the WSF occupied one-fourth of the Shuttle payload bay. The controlling electronics, attitude control system, batteries and solar panels, and Molecular Beam Epitaxy (MBE) process control equipment were on the back of the WSF, while the avionics and support equipment were on the front. The commercial approach used to create the WSF facilitated the development of several critical pieces of supporting hardware that proved to be extremely useful on their own. The

³⁹² "Wake Shield Facility Program," Space Vacuum Epitaxy Center, University of Houston, <http://www.svec.uh.edu/wsf.html> (accessed February 9, 2006).

development of an inexpensive carrier (the SCBC), a versatile ground link, and an innovative communications link between the Shuttle and the WSF were valuable spinoffs from the WSF program.³⁹³ Figure 2-39 shows the WSF at the end of the Shuttle's robot arm.



Figure 2-39. The Wake Shield Facility (WSF), pictured at the end of the Shuttle's robot arm, is a free-flying research and development facility that uses the pure vacuum of space to conduct scientific research on the development of new materials. The thin-film materials technology developed by the WSF could some day lead to applications such as faster electronics components for computers (NASA photo MSFC-9901881).

Wake Shield Facility

WSF-1 was carried on the STS-60 Space Shuttle mission. It was to be deployed by the remote manipulator system (RMS) arm and fly freely in formation with *Discovery* at a distance of up to 46 miles (74 kilometers) from the orbiter for 56 hours. It was then to be retrieved from space, again using the RMS arm. However, after two unsuccessful attempts to deploy the facility

³⁹³ "Space Shuttle Mission STS-60 Press Kit," February 1994, p. 16.

because of difficulties in attitude control, it was decided that for the remainder of the mission, all WSF operations would take place at the end of the RMS arm and there would be no WSF free-flying operations. During the mission, five GaAs thin films were grown before the facility was berthed.³⁹⁴ Although the results of WSF-1 demonstrated wake formation and thin-film growth, water-vapor contamination from the Shuttle prevented researchers from achieving the ultravacuum necessary to grow semiconductor materials superior to those that could be grown on Earth.³⁹⁵ This was the first time internationally that the vacuum of space was used to process thin-film materials.³⁹⁶

SVEC at the University of Houston, with its principal industry partner, Space Industries, Inc. (SII), designed and built the WSF. The WSF program was supported by six additional corporate partners: American X-tal Technology; AT&T Bell Labs; Instruments, S.A., Inc.; Ionwerks; Quantum Controls; and Schmidt Instruments, Inc. In addition, the University of Toronto, Johnson Space Center, USAF Phillips Laboratories (located at Hanscom Air Force Base), and the U.S. Army Construction Engineering Research Laboratory were members of the SVEC consortium. NASA's Office of Advanced Concepts and Technology (OACT) sponsored the WSF-1 flight.³⁹⁷

Cooperative Experiments

A number of cooperative experiments had been planned for WSF-1. The University of Toronto Institute for Aerospace Studies (UTIAS) was to perform exposure experiments aboard WSF-1 as

³⁹⁴ "STS-60 Shuttle Mission Archive," <http://www-pao.ksc.nasa.gov/kscpao/shuttle/missions/sts-60/mission-sts-60.html> (accessed February 9, 2006).

³⁹⁵ "Space Shuttle Mission STS-69 Press Kit," p. 15, <http://science.ksc.nasa.gov/shuttle/missions/sts-69/sts-69-press-kit.txt> (accessed February 9, 2006).

³⁹⁶ "Space Shuttle Mission STS-60 Press Kit," February 1994, p. 14.

³⁹⁷ "Space Shuttle Mission STS-60 Press Kit," February 1994, p. 14.

a follow-up to its Long Duration Exposure Facility (LDEF) studies. A NASA CCDS, the Center for Materials for Space Structure (CMSS), based at Case Western Reserve University, Cleveland, Ohio, was to conduct an experiment to test different materials and coatings in space to determine how they degraded in the space environment. The experiment was known as MatLab-1 (for Materials Laboratory-1). Industrial contributors to the MatLab-1 experiment included Westinghouse-Hanford, Martin Marietta, TRW, Rosemount, 3M, Dow Corning, and McDonnell Douglas. Supporting government organizations included NASA's Lewis Research Center and JPL. The MatLab-1 was mounted on the Materials Flight Experiment carrier on the front of the WSF. Materials scientists on Earth were to monitor the experiments in real time.

The Geophysics Directorate at the USAF Phillips Laboratory working with SVEC was to fly the Charging Hazards and Wake Studies (CHAWS) experiment on the WSF Free Flyer. The general purpose of the experiment was to learn about interactions between the space environment and space systems and the hazards such interactions posed, in order to enhance both the commercial and military utilization of space.

Working with Johnson Space Center engineers, SVEC offered the WSF as a testbed for the development of highly sensitive accelerometers, called Microgravity Measurement Devices. Specifically, on WSF-1, the accelerometers were to characterize the microgravity environment of the WSF Free Flyer.

Two Smart Cans attached to the WSF's SCBC on WSF-1 were to conduct a Containerless Coating Process experiment. The U.S. Army Construction Engineering Research Laboratory was

to use the Smart Cans to investigate the deposition of hot-filament, thin-film metals on a variety of materials to give researchers information about applying reflective coatings to space structures while in space.

In addition, two student experiments were to be a part of WSF-1. The Fast Plants experiment was coordinated by Hartman Middle School, Houston, Texas, to study the effects of space radiation on the generation of plants. Ninth-grade students at Gregory Jarvis Junior High School, Mohawk, New York, were to determine the orbital variation of Earth's magnetic field from electron diffraction data obtained in the WSF thin-film growth experiments.

WSF-2

WSF-2, the second in a planned series of four missions, launched on Space Shuttle mission STS-69 on 7 September 1995. Following the failure to deploy WSF-1, a WSF advisory committee had reviewed flight anomalies and approved corrective actions. Subsequently, a NASA independent review board evaluated all systems and unanimously agreed that WSF-2 was ready for flight.

The STS-69 crew successfully deployed WSF-2 on flight day 5. It flew separately from the Shuttle for three days and produced an ultravacuum in its wake, allowing experimentation in the production of advanced thin-film semiconductor materials.³⁹⁸ WSF-2 became the first spacecraft to maneuver itself away from the orbiter rather than the other way around by firing a small cold-gas nitrogen thruster to move away from *Endeavour*.

³⁹⁸ "STS-69 Mission Archives, Day 8 Highlights," <http://science.ksc.nasa.gov/shuttle/missions/sts-69/sts-69-day-08-highlights.html> (accessed February 9, 2006).

The principal objectives of the WSF-2 mission were to 1) fly the WSF freely and far enough away from the orbiter to achieve and characterize for the first time an uncontaminated ultravacuum in low-Earth orbit, and 2) demonstrate the feasibility of epitaxial growth of high-quality compound semiconductor thin films and heterostructures required for future advanced electronic and optoelectronic devices as part of the WSF proof-of-concept program.

Unfortunately, the experiment had to be terminated and the spacecraft retrieved sooner than planned because of overheating problems.³⁹⁹

During the mission, four successful thin-film growth runs were completed.⁴⁰⁰ The WSF flew 30 nautical miles (55.6 kilometers) behind the Shuttle while the thin films were grown. During this time, it was operated from the POCC at Johnson Space Center. The SVEC team monitored and controlled all aspects of WSF operations along with the astronaut crew. Cooperative payloads were operated from the Commercial Payload Command Center at Space Industries a few miles from Johnson.⁴⁰¹

In addition to SVEC and SII (the designers and builders of the WSF), ten corporate sponsors supported the WSF-2 mission: Advanced Modular Power Systems; American Xtal Technology; AKZO Chemicals, Inc.; Honeywell Satellite Systems; Ionwerks; International Stellar Technology, Inc.; Instruments, S. A., Inc.; Lockheed Martin; MKS Instruments; and S.I. Diamond, Inc. Other members of the SVEC consortium included Baylor University, Case Western Reserve University, Lamar University, the University of Texas at Dallas, the University

³⁹⁹ “Wake Shield Facility 2,” NSSDC Master Catalog, <http://nssdc.gsfc.nasa.gov/database/MasterCatalog?sc=1995-048C> (accessed February 9, 2006).

⁴⁰⁰ “Space Shuttle Mission STS-69 Mission Archives,” http://www.nasa.gov/mission_pages/shuttle/shuttlemissions/archives/sts-69.html (accessed May 23, 2007).

⁴⁰¹ “Space Shuttle Mission STS-69 Press Kit.”

of Texas at Austin, the University of Toronto, Johnson Space Center, Marshall Space Flight Center, Lewis Research Center, and the USAF Phillips Laboratories. NASA's Office of Space Access and Technology sponsored the mission.

The WSF Platform

As a free-flying platform, the WSF's wake side—the “ultraclean side”—was used on this mission primarily for ultrapure thin-film growth. The ram side—the “dirty side”—housed the avionics platform and also accommodated other experiments and space-technology applications. The ram side had more than 65 square feet (6 square meters) of usable surface in the form of an outer shield that could support other space payloads.

Since the WSF was mounted horizontally in the Shuttle payload bay, the open volume below the WSF was effectively used by mounting Smart Cans on the Cross Bay Carrier. WSF power and data capabilities were extended to these canisters. The carriers enabled other payloads to fly with the WSF, and several additional experiments were undertaken on WSF-2.⁴⁰²

Cooperative WSF-2 Payloads: Free-Flyer Experiments

The GPS experiment dual-mode experiment from the University of Texas at Austin used a GPS receiver to determine the precise position and velocity of the WSF, while GPS signal-strength attenuation was used to determine atmospheric temperature profiles. Partially funded by a JSC regional university grant, the GPS experiment operated during the free-flight portion of the WSF-2 mission to record position, velocity, signal strength, and diagnostic information. The system was activated by ground command from the JSC POCC. Data were collected on board,

⁴⁰² “Space Shuttle Mission STS-69 Press Kit.”

stored in a unique solid-state recording device developed for this mission by JSC, and analyzed after the flight.

The Shuttle Plume Impingement Experiment supported space station development. A series of Shuttle thruster firings at a variety of distances from the WSF used the WSF's response as a measure of the characteristics of the Shuttle's thruster plumes.

The Neutral Mass Spectrometer (NMS), developed by Lamar University and the University of Texas at Dallas, tested a magnetic-sector field mass spectrometer designed to measure the ultravacuum created in the wake of the WSF. Located on the WSF's outer shield, the NMS was ground-commanded for operations during the free-flight portion of the mission.

The Cosmic Dust and Orbital Debris Experiment Monitor (CoDEM), from the Baylor University Space Science Laboratory, collected and characterized the near WSF environment with in situ measurements of dynamic and physical characteristics of particulate matter. It was a self-contained experiment that required no interaction from the ground during on-orbit operations.

The Earth Reference Attitude Determination System (ERADS), from Honeywell Satellite Systems, used Earth and Sun sensors in combination on the rim of the WSF. The sensor had an annular FOV that permitted Earth limb and star field viewing. ERADS was activated and controlled from the ground, and collected data in an on-board data recorder. The data were processed after landing. Real-time interaction was limited to state of health and system activation/deactivation.

The Materials Exposure Experiment, developed by the University of Toronto Institute for Aerospace Studies, collected data on atomic oxygen interaction with various materials. This passive exposure experiment was mounted on top of the WSF batteries facing into the velocity vector (ram direction). The experiment exposed more than 150 samples of 26 different materials to the space environment and gathered data on how the materials were affected.

The Hyper Velocity Impact Capture Experiment, developed by JPL, was a passive debris collection/exposure experiment that had flown on previous Shuttle missions. The experiment had three collectors—two on the WSF free flyer, and one remaining on the SCBC in the Shuttle payload bay. The experiment measured space debris around the WSF and compared it with data collected on previous spaceflights.

Charging Hazards and Wake Studies (CHAWS), an experiment from the Air Force's Phillips Laboratory that had flown on WSF-1, measured ambient low-energy, positively charged particles, and studied the magnitude and directionality of the current collected by a negatively charged object in the plasma wake. Its goal was to increase understanding of the interactions between the space environment and space systems, and the hazards these interactions created for satellite systems. The CHAWS experiment collected its primary data while the WSF was attached to the Shuttle robot arm.

Cooperative WSF-2 Payloads: SCBC Experiments

The Iowa Joint Experiment on Microgravity Solidification, constructed by the Iowa Space Grant Consortium, was carried in a WSF Smart Can located on the SCBC. The overall objective of the

experiment was to examine the effects of a microgravity environment on the solidification process of a tin-cadmium alloy imbedded with particulate matter. During the WSF-2 mission, the crew activated the experiment by using the Shuttle standard switch panel. All experiment events were pre-programmed and the experiment was autonomous.

The Advanced Process Controller (APC) was a joint Space Industries and SVEC venture for development and space qualification of a PC-type process controller. The process controller was located in a Smart Can and was used to monitor temperature, current, and voltage, as well as to provide relay control functions. The APC was activated by the flight crew using the standard switch panel. Ground commands originated from the POCC at JSC.

The Long Range AutoTRAC, developed by an engineering team at JSC, was a video system for testing light-enhanced photogrammetric ranging techniques on orbit.

Other Experiments Supported by the WSF

The MagField Experiment, undertaken by tenth-grade students at Gregory Jarvis High School in Mohawk, New York, determined the variation of Earth's magnetic field from magnetometer and electron diffraction data obtained during the WSF-2 mission. Data collected during the mission was given to the school for postflight analysis.⁴⁰³

WSF-3

The third flight of the WSF took place on Space Shuttle mission STS-80, launched 19 November 1996. The facility flew the WSF at a distance of about 20–25 nautical miles (37–46 kilometers)

⁴⁰³ "Space Shuttle Mission STS-69 Press Kit."

behind *Columbia* and no less than 25 nautical miles (46 kilometers) from the second Shuttle free-flying payload, the Orbiting and Retrievable Far and Extreme Ultraviolet Spectrograph-Shuttle Pallet Satellite (ORFEUS-SPAS), before its retrieval by *Columbia* on flight day 7.⁴⁰⁴ It was the first time two free-flying spacecraft were deployed and retrieved during a single Shuttle mission.

The major objective of this flight was to grow thin epitaxial films that could have a significant effect on the microelectronics industry. A number of cooperative payloads flew in conjunction with WSF-3.⁴⁰⁵ The flight was highly successful, with a maximum of seven thin-film growths achieved.⁴⁰⁶

Cryogenic Infrared Spectrometers and Telescopes for the Atmosphere-Shuttle Pallet Satellite (CRISTA-SPAS)

CRISTA-SPAS was a limb-scanning satellite experiment mounted on the free-flying ASTRO-SPAS satellite. It was deployed and retrieved by the Shuttle's remote manipulator system arm when in orbit and operated at a distance of 20–100 kilometers (12.4–62.1 miles) behind the Shuttle.

The CRISTA-SPAS experiment was designed and developed by the University of Wuppertal in Germany to measure infrared emissions of Earth's atmosphere. Its primary scientific objective was to study small-scale dynamical structures seen in the global trace gas distributions. It was equipped with three telescopes and four spectrometers. CRISTA acquired global maps of

⁴⁰⁴ "KSC Fact Sheet—STS-80," KSC Release No. 124-96, October 1996, <http://www-pao.ksc.nasa.gov/kscpao/release/1996/124-96.htm> (accessed February 9, 2006).

⁴⁰⁵ "Space Shuttle Mission STS-80 Press Kit," http://www.jsc.nasa.gov/history/shuttle_pk/pk/Flight_080_STS-080_Press_Kit.pdf (accessed February 9, 2006).

⁴⁰⁶ "STS-80 Mission Archives," http://www.nasa.gov/mission_pages/shuttle/shuttlemissions/archives/sts-80.html (accessed March 27, 2006).

temperature and atmospheric trace gases with very high horizontal and vertical resolution. For improved horizontal resolution, the three telescopes sensed the atmosphere simultaneously at angles 18 degrees apart. To achieve high measuring speed and, consequently, high spatial resolution along the track, it used cryogenic helium to cool the detectors and optics.⁴⁰⁷ The design enabled the observation of small-scale dynamical structures at altitudes of 15–150 kilometers (9.3–93.2 miles). The data were also used to test three-dimensional chemical-dynamic model predictions.

CRISTA-SPAS flew together with the Middle Atmospheric High Resolution Spectrograph Investigation (MAHRSI), an ultraviolet spectrograph from the U.S. Naval Research Laboratory.⁴⁰⁸

The ASTRO-SPAS program was based on an MOU between NASA and the German space agency (DARA) and provided for several joint missions. The first of these missions—the Orbiting and Retrievable Far and Extreme Ultraviolet Spectrograph (ORFEUS)-SPAS—was launched in September 1993 aboard STS-51. CRISTA-SPAS was the second mission in the series.⁴⁰⁹ SPAS was a joint scientific program between NASA and DARA developed by Messerschmitt-Boelkow-Blohm (MBB) in Germany. SPAS was used as a reusable carrier for short-duration missions.⁴¹⁰

⁴⁰⁷ “CRISTA/MAHRSI Campaign 2 Handbook: Chapter II: CRISTA Experiment,” <http://www.crista.uni-wuppertal.de/campaigns/handbook/hb-ii.html> (accessed February 9, 2006).

⁴⁰⁸ “CRISTA-SPAS 1, 2,” http://space.skyrocket.de/index_frame.htm?http://space.skyrocket.de/doc_sdat/crista-spas.htm (accessed 9 February 2006).

⁴⁰⁹ See chapter 4 in volume VII of the *NASA Historical Data Book (1989–1998)* for further details of the ORFEUS-SPAS mission. Also “Space Shuttle Mission STS-66 Press Kit,” November 1994, p. 27, <http://www.nasa.gov/centers/kennedy/shuttleoperations/archives/sts-66.html> (accessed February 9, 2006).

⁴¹⁰ “CRISTA/SPAS,” NSSDC Master Catalog, <http://nssdc.gsfc.nasa.gov/database/MasterCatalog?sc=1994-073B> (accessed February 9, 2006).

CRISTA-SPAS-1

CRISTA-SPAS-1 was one of two primary payloads on Space Shuttle mission STS-66. It was comanifested with the third flight of ATLAS-3, and both CRISTA and MAHRSI were integrated into the ATLAS-3 Science Plan. CRISTA-SPAS was released from the Shuttle's cargo bay on 4 November 1994, the second day of the mission, and retrieved eight days later using the Shuttle's remote manipulator system arm. It was then reberthed and returned to Earth with the Shuttle. CRISTA-SPAS flew at a distance of 25–44 miles (40–70 kilometers) behind the Shuttle, collecting data that was then stored on tape. Batteries powered the carrier.

CRISTA-SPAS-1 consisted of two instruments: the CRISTA for observing the atmospheric limb and the MAHRSI for dayglow studies. CRISTA was a German telescope/cryostat assembly sensitive in the 4–70-micrometer range for making infrared observations of Earth's atmosphere. This limb-sounding instrument used three independent telescopes. CRISTA contained on-board batteries and cryogenic and nitrogen cold-gas maneuvering subsystems. The instrument gathered the first global information about medium- and small-scale disturbances in trace gases in the middle atmosphere, which could lead to better models of the atmosphere and Earth's energy balance.⁴¹¹ MAHRSI measured amounts of ozone-destroying hydroxyl and nitric oxide in the middle atmosphere and lower thermosphere from altitudes of 24–72 miles (40–120 kilometers). MAHRSI yielded the first complete global maps of atmospheric hydroxyl.⁴¹²

⁴¹¹ "Cryogenic Infrared Spectrometers and Telescopes for the Atmosphere (CRISTA)," NSSDC Master Catalog-Experiments, <http://nssdc.gsfc.nasa.gov/database/MasterCatalog?sc=1994-073B&ex=1> (accessed February 9, 2006).

⁴¹² "STS-66 Mission Archive," <http://www.nasa.gov/centers/kennedy/shuttleoperations/archives/sts-66.html> (accessed February 9, 2006).

CRISTA-SPAS-2

CRISTA-SPAS-2 was deployed from STS-85 on August 8, 1997. It flew freely for more than 200 hours before being retrieved using *Discovery*'s robot arm. This was CRISTA-SPAS's second flight and the fourth in a series of cooperative ventures conducted by DARA and NASA.

CRISTA consisted of three telescopes and four spectrometers. The three telescopes collected 38 full atmospheric profiles of the middle atmosphere. The payload also included the MAHRSI and a passive experiment, the Surface Effects Sample Monitor (SESAM). Two additional experiments mounted on the SPAS were activated during free flight. The Mini Dual Earth Sensor gathered operational data about Earth horizon positions, and Interferometry Program Experiment-II measured the vibration of the SPAS structure.⁴¹³

This CRISTA instrument offered researchers the opportunity for latitudinal coverage of the atmosphere beyond that achieved during STS-66. It acquired data about summer conditions at high northern latitudes and the polar night at high southern latitudes. Specifically, it provided

- Increased horizontal resolution (100 kilometers by 100 kilometers, or 62 miles by 62 miles) in selected areas at the equator
- Increased latitudinal coverage (74°S to 74°N)
- Increased altitude range (scanned below the tropopause)
- Increased sensitivity (improved measurements of carbon monoxide, nitric oxide, temperature, and pressure)

⁴¹³ "CRISTA-SPAS 2" NSSDC Master Catalog, <http://nssdc.gsfc.nasa.gov/database/MasterCatalog?sc=1997-039B> (accessed February 9, 2006).

- Increased validation measurements (by rocket salvos, instrumented rockets, and aircraft with “zero miss distance”)
- High-resolution measurements in the winter Southern Hemisphere⁴¹⁴

CRISTA’s detailed high-horizontal-resolution information complemented less well resolved but longer-duration data from other free flyers, such as UARS. During *Discovery*’s flight, ground-based researchers conducted extensive balloon, aircraft, and sounding-rocket campaigns to gather data that were compared with CRISTA telescope data.⁴¹⁵ Figure 2-40 shows the CRISTA-SPAS being prepared for flight.

⁴¹⁴ “CRISTA/MAHRSI Campaign 2 Handbook: Chapter II: CRISTA Experiment,” <http://www.crista.uni-wuppertal.de/campaigns/handbook/hb-ii.html> (accessed February 9, 2006).

⁴¹⁵ “Space Shuttle Mission STS-85 Press Kit,” August 1997, p. 16, http://www.jsc.nasa.gov/history/shuttle_pk/pk/Flight_086_STS-085_Press_Kit.pdf (accessed February 10, 2006).

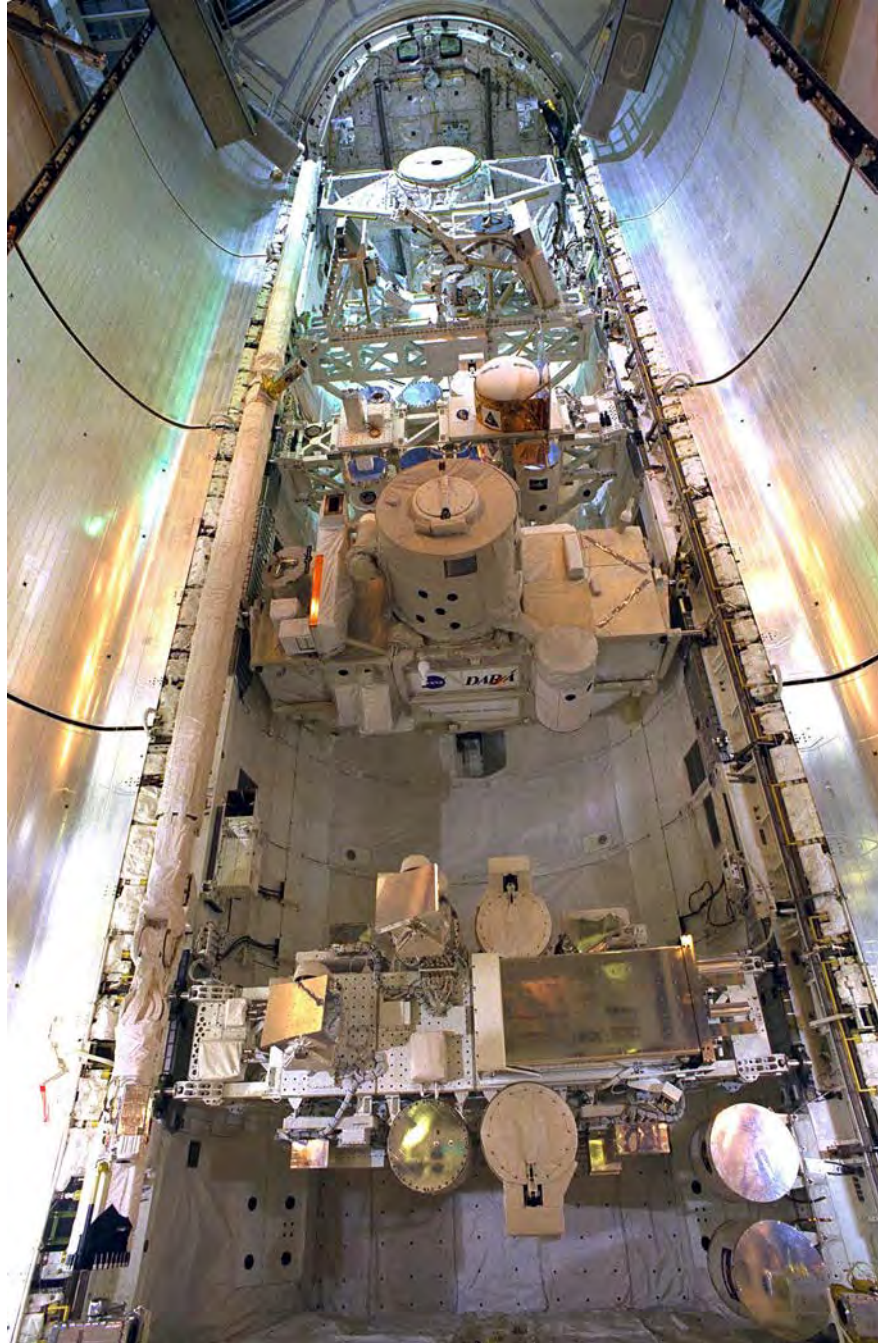

Figure 2-40. The final tasks to prepare the CRISTA-SPAS-2 payload for the STS-85 mission are completed aboard Discovery at Launch Complex 39A (NASA photo KSC-97PC-1192).

CHAPTER 3: AERONAUTICS, TECHNOLOGY, AND EXPLORATION

Introduction

This chapter describes NASA's aeronautics, research and technology (R&T), and exploration activities. It includes an overview of Agency programs, a description of the management structure and personnel, budget information, and an account of specific activities in these areas.

The National Aeronautics and Space Act included the following among NASA's goals:

. . . (2) The improvement of the usefulness, performance, speed, safety, and efficiency of aeronautical and space vehicles; . . . (4) The establishment of long-range studies of the potential benefits to be gained from, the opportunities for, and the problems involved in the utilization of aeronautical and space activities for peaceful and scientific purposes; (5) The preservation of the role of the United States as a leader in aeronautical and space science and technology and in the application thereof to the conduct of peaceful activities within and outside the atmosphere; . . . [and] (9) The preservation of the United States' preeminent position in aeronautics and space through research and technology development related to associated manufacturing processes.¹

NASA's activities during the decade of 1989 to 1998 supported these goals.

NASA's aeronautics, R&T, and exploration activities were built on a foundation that was established during the era of the National Advisory Committee for Aeronautics (NACA),

¹ *The National Aeronautics and Space Act, As Amended*, Public Law 85-568, 72 Stat. 426, 438, July 29, 1958, http://www.nasa.gov/offices/ogc/about/space_act1.html#POLICY (accessed June 8, 2006).

NASA's predecessor agency. Its aeronautics activities focused on meeting national goals in the subsonic, transatmospheric, and supersonic regions of flight. The Agency worked to improve global civil aviation and advance aeronautical technology. Space R&T initiatives supported and provided technology related to the Space Shuttle, America's launch systems, satellites, and space station. These activities focused on future civil space missions, improving access to space, and providing a base of R&T to support all national space goals. Exploration activities grew largely out of recommendations made by a committee chaired by former NASA astronaut Sally Ride to the NASA Administrator in 1987, and presidential initiatives of the late 1980s and early 1990s that addressed the importance of regaining America's leadership in space endeavors after the *Challenger* accident.

As is customary in these data books, most of the material in this chapter is based on primary NASA documents and Web-based materials produced by NASA. These include press releases, key personnel announcements, various reports and plans issued by the Agency, budget documents, and the annual Aeronautics and Space Report of the President. Most of the budget material comes from the annual budget estimates generated by the NASA Office of the Chief Financial Officer and from federal budget legislation. Measurements are presented in the unit used in the original reference (metric or English); conversions are in parentheses.

The Last Decade Reviewed

During the decade from 1979 to 1989, NASA carried out aeronautics and space R&T activities through its Office of Aeronautics and Space Technology (OAST). Disciplinary research centered on aerodynamics, materials and structures, propulsion, aerothermodynamics, energy conversion, controls and human factors, computer science, and information sciences. Systems work was

often multidisciplinary and had more immediate applications than other research. It usually supported other NASA projects, such as the Space Shuttle, developed technologies to enable future projects, such as the space station, and supported the military and other federal agencies. NASA's aeronautics activities were centered at Ames Research Center in Moffett Field, California, Langley Research Center in Hampton, Virginia, Lewis Research Center in Cleveland, Ohio, and Dryden Flight Research Facility in Edwards, California.² All NASA centers were involved with the Agency's space R&T programs.

Aeronautics

In the early part of the 1980s, OAST emphasized flight efficiency and the development of improved energy technology. It supported national energy needs through its Energy Technology program, sponsored by the U.S. Department of Energy (DOE) and other federal agencies. The Aircraft Energy Efficiency program worked to improve flight efficiency and develop solutions to problems faced by current aircraft, as well as those expected within a few years, and to plan new fuel-efficient classes of aircraft. Turboprop research, new composite materials, more aerodynamically efficient wing shapes, and different wing configurations all contributed to improving flight efficiency. Aircraft safety was a particular focus. NASA carried out research on windshear, icing, heavy rain, lightning, and combustible materials on aircraft, often cooperatively with the Federal Aviation Administration (FAA) and aircraft manufacturers. It also worked with the FAA, the Department of Transportation, and aircraft manufacturers to lessen any harmful effects of flight on the environment.

² Dryden Flight Research Center was an independent NASA center until October 1981, when it became a directorate of Ames Research Center with the name Dryden Flight Research Facility. It became an independent NASA center again in 1994.

Other research targets were the large-capacity short takeoff and landing (STOL) and vertical takeoff and landing (VTOL) aircraft. These aircraft were planned for use at airports near populated areas. Quieter engines were also needed in these locations, and NASA, along with members of the industry, developed an experimental engine that generated significantly less noise. Related developments advanced vertical and short takeoff and landing (V/STOL) and short takeoff and vertical landing (STOVL) technologies.

Rotary wing aircraft for both civilian and military applications was another primary focus. The Tilt-Rotor Research Aircraft (TRRA) had twin rotors and engines mounted at the ends of a high wing. Its rotors could be tilted, permitting both vertical and horizontal flight. The Sikorsky Rotor Systems Research Aircraft (RSRA) used helicopter rotor heads as the basic lifting system but was designed to test a variety of rotor systems. This aircraft could be configured to fly as a conventional helicopter or as a compound helicopter with fixed wings, and could be fitted with a variety of experimental and developmental rotor systems for research purposes.

OAST supported the military in the area of high-performance aircraft technologies, frequently partnering with the Department of Defense (DOD). The Highly Maneuverable Aircraft Technology (HiMAT) program tackled problems associated with combining high maneuverability, high speed, and a human pilot. NASA researchers studied the interrelated problems of all aspects of typical advanced-fighter flight configurations and contributed to the design of future fighter aircraft by furnishing fundamental aerodynamic and structural-loads data to assist designers. The X-29A flight research program was another program that was developed in cooperation with the military. It demonstrated the forward-swept-wing configuration as well

as digital fly-by-wire technology and an innovative flight-control system. NASA used an F-18 Hornet fighter aircraft in its High Angle of Attack Research Vehicle (HARV) program.³ This program attempted to expand an aircraft's "stall barrier"—the tendency of an aircraft to become uncontrollable and stall at low speeds and high angles of attack (AoAs).

A major program during this decade involved the National Aerospace Plane (NASP), designated the X-30. The goal of this hypersonic aircraft program, which was proposed by President Ronald Reagan and initiated by the military, was to develop and demonstrate the technologies needed to fly an aircraft into orbit by using air-breathing propulsion instead of rockets. The developers envisioned an actual experimental transatmospheric vehicle that would take off horizontally from a conventional runway, reach speeds as high as Mach 25, leave Earth's atmosphere and enter low-Earth orbit, reenter the atmosphere, and finally land horizontally. As the decade ended, however, technical difficulties and competition for funds made the program more controversial.

Space

NASA's space R&T program provided advanced technologies to develop more capable and less costly space transportation systems, large space systems with growth potential (such as the space station), geosynchronous communications platforms, lunar bases, crewed planetary missions, and advanced scientific Earth observation and planetary exploration spacecraft. Some space technology programs investigated the problems related to providing power, controls and structures, and assembly of large space structures. Other research areas included spacesuit studies, research related to more efficient reentry into Earth's atmosphere from space, advanced power systems for future lunar and Mars bases, and lighter tanks for cryogenic fuels. Still other investigations dealt with control systems for future large, lightweight spacecraft and the

³ This was sometimes called the High Alpha Research Vehicle program.

assembly of large space structures with teleoperated manipulators, as well as a program to allow free-flying telerobots to grapple and dock with gyrating satellites to stabilize and repair spacecraft. Other space-related research areas included the development of improved batteries, solar cells, and solar arrays.

OAST programs developed and demonstrated the Space Shuttle's thermal protection system (TPS) and continued to improve the composition and durability of the materials. OAST developed the experiments on the Orbiter Experiments program, which debuted on the first Shuttle mission. These experiments evaluated the aerodynamic, aerothermodynamic, acoustic, and other stress-related phenomena encountered in spaceflight, particularly during the Shuttle's hypersonic return to Earth's atmosphere. OAST participated in several Shuttle payloads, including the experiments that flew on the Long-Duration Exposure Facility (LDEF) on mission STS 41-C and the OAST-1 mission on STS 41-D.

OAST's technology initiatives were applied to the development of the space station. The mobile workstation that enabled astronauts to assemble the station in space was developed by OAST researchers, as were the innovative assembly techniques and structures. Automation and robotics were important research areas.

NASA's Civilian Space Technology Initiative (CSTI) began in 1988. It addressed the high-priority national and Agency needs of the 1990s and aimed to advance the state of technology in key areas where capabilities had eroded and stagnated. Its prime focus was space transportation, space science, and space operations.

Aeronautics and Space R&T Overview (1989–1998)

From the early 1970s until 1993, aeronautics and space R&T activities were managed by a single organization— OAST. In 1993, space technology was assigned to a new organization— the Office of Advanced Concepts and Technology (OACT), which also incorporated programs from the former Office of Commercial Programs. In 1994, OACT was disbanded, and space technology and commercial programs were moved to the Office of Space Access and Technology (OSAT). During both of these restructurings, aeronautics programs remained in the separate Office of Aeronautics. In 1997, the aeronautics, space technology, and commercial programs were combined into the Office of Aeronautics and Space Transportation Technology (OASTT), which in 1998 was shortened to the Office of Aerospace Technology (OAT).

At the national level, aeronautics and space technology development was coordinated through the National Science and Technology Council (NSTC), which was established on November 23, 1993 by executive order of President William Clinton. The Cabinet-level Council, which acted as a “virtual” agency for science and technology, was the principal means by which the President could coordinate science, space, and technology policies across the Federal government. An important objective of the NSTC was to establish clear national goals for federal science and technology investments in a broad array of areas spanning virtually all mission areas of the executive branch. The President chaired the NSTC and its membership consisted of the Vice President, the Assistant to the President for Science and Technology, Cabinet secretaries, Agency heads with significant science and technology responsibilities, and other senior White House officials.

NASA's aeronautics and space R&T programs provided technological results in advance of specific application needs and conducted long-term independent research without the payoff of immediate known mission applications. Its programs were derived from several fundamental disciplines and from systems and classes of vehicles. Disciplinary research applied to more than one class of vehicles and sometimes related to as-yet undefined capabilities. Systems and vehicle research enhanced the capabilities of specific classes of vehicles in both aeronautic and space-based transportation areas, and also crossed boundaries between the two.

*Aeronautics*⁴

For much of the decade, NASA's aeronautics program consisted of two complementary program areas: an R&T base of critical disciplines, and a series of focused programs. In addition, a group of advanced aeronautical research facilities was a major component of NASA's aeronautical research. The aeronautics R&T base included work in the critical disciplines of aerodynamics, propulsion, materials and structures, information sciences and human factors, and flight systems and safety.

NASA's aeronautics and R&T programs continued to be conducted at four NASA centers: Ames Research Center (ARC) at Moffett Field, California; Dryden Flight Research Center (DFRC) at Edwards, California; Langley Research Center (LaRC) in Hampton, Virginia; and Lewis Research Center (LeRC) in Cleveland, Ohio.

⁴ National Aeronautics and Space Administration Office of Aeronautics and Space Technology, *NASA Aeronautics: Research and Technology, Program Highlights*, NP-129, [no date], c. 1990. Also National Aeronautics and Space Administration, Office of Aeronautics and Space Transportation Technology, *Aeronautics & Space Transportation Technology, Three Pillars for Success, Annual Progress Report 1997–1998*, p. 12.

Ames had distinctive facilities for aerodynamic testing and flight simulation that were used to validate analytical methods and conduct research investigations of small- and large-scale aeronautical vehicle configurations. The center also conducted research on human factors, aircraft automation, flight dynamics, guidance, and digital controls.⁵ Ames' areas of aeronautical excellence encompassed computational fluid dynamics (CFD) and computer science applications that focused on the development of new analytical methods to use the growing power of advanced computers. During the first part of the decade, flight operations were centered at Ames. In 1995, as part of the Agency's Zero Based Review, the branch was disbanded. All aircraft in the NASA fleet—both operational and experimental—were consolidated at Dryden.⁶ Ames was the Agency's Center of Excellence for information technology and led in astrobiology and aviation system safety and capacity.⁷

Dryden complemented Ames' ground-test capability. Key systems technology areas at the two centers included propulsion/airframe integration, powered-lift technology, and rotorcraft aeromechanics. In 1994, Dryden again became an independent NASA center.

Langley's areas of aeronautical excellence included fundamental aerodynamics and fluid dynamics, computer science, unsteady aerodynamics, and aeroelasticity. Aerodynamic testing to support research in each of these areas was a major focus. Langley was also a leader in structures and materials research, with a primary focus on developing and validating structural analysis methods and research in airframe metallic and composite materials. It also conducted

⁵ *NASA Aeronautics, Research and Technology Program Highlights*, NP-129, p. 50.

⁶ Glenn E. Bugos, *Atmosphere of Freedom: Sixty Years at the NASA Ames Research Center* (Washington, DC: NASA SP-4314, 2000), pp. 226–227.

⁷ *Ibid.*, p. 227.

fundamental research on fault-tolerant electronic systems and flight control. Special areas of research included simulation and evaluation of advanced operational aircraft systems, acoustics and noise reduction, and propulsion/airframe integration.⁸

Lewis' area of excellence was propulsion, divided into the areas of aeropropulsion, space propulsion, space power, and space science/applications.

A number of documents helped shape aeronautics objectives and policy. For the first part of the decade, aeronautics policy and objectives were largely determined on the basis of two reports issued by the President's Office of Science and Technology Policy in 1985 and 1987. The 1985 report, "National Aeronautics R&D Goals: Technology for America's Future," described specific goals in subsonics, supersonics, and transatmospherics. The subsonic goal was to provide technology for an entirely new generation of fuel-efficient, affordable U.S. aircraft operating in a modernized national airspace system. The supersonic goal focused on developing "pacing technologies" to achieve a sustained supersonic cruise capability for efficient long-distance flight. The transatmospheric goal was to pursue research leading to the capability to routinely cruise and maneuver into and out of the atmosphere with takeoffs and landings from conventional runways. The report recommended a restructuring of federal contracting procedures, a regulatory policy to encourage cooperation among U.S. companies, federal tax legislation to stimulate private investment, and continuity of R&T development activities among all involved branches of government.⁹ The 1987 report recognized the progress that was taking

⁸ *NASA Aeronautics, Research and Technology Program Highlights*, NP-129, p. 51.

⁹ Executive Office of the President, Office of Science and Technology Policy, "National Aeronautics R&D Goals: Technology for America's Future," March 1985, <http://www.aero-space.nasa.gov/docs/nstc85.htm> (accessed June 26, 2006).

place toward meeting the 1985 goals, but stated that “greater achievement by all sectors—government, industry, and academia” was needed to meet the “challenge to our competitiveness” so that the United States could “remain a viable competitor in the world aviation marketplace.” It made eight recommendations for action to guide the “agenda for achievement”:

1. Increase innovative industry research and development efforts given the certainty of intensifying global competition and the importance of new technology for U.S. competitiveness.
2. Aggressively pursue the National Aerospace Plane program, assuring maturation of critical technologies leading to an experimental airplane.
3. Develop a fundamental technology, design, and business foundation for a long-range supersonic transport in preparation for a potential U.S. industry initiative.
4. Expand domestic research and development collaboration by creating an environment that reflects the new era of global competition.
5. Encourage government aeronautical research in long-term emerging technology areas that provide high payoffs.
6. Strengthen American universities in the areas of basic research and science education through enhanced government and aerospace industry support and cooperation.
7. Improve the development and integration of advanced design, processing, and computer-integrated manufacturing technologies to transform emerging research and development results into affordable U.S. products.

8. Enhance the safety and capacity of the National Airspace System through advanced automation and electronics technology and new vehicle concepts, including vertical and short takeoff and landing aircraft.¹⁰

In 1995, the NSTC issued a report presenting the “framework for a government, industry, and university partnership in aeronautics research and technology development” needed for the United States to maintain its leadership in aeronautics technology and manufacturing. It identified three goals to be pursued by this partnership:

1. Maintain the superiority of U.S. aircraft and engines.
2. Improve the safety, efficiency, and cost-effectiveness of the global air transportation system.
3. Ensure the long-term environmental compatibility of the aviation system.¹¹

This report was followed in 1997 by the first Transportation Science and Technology Strategy issued by the NSTC. The new report offered a strategic planning process and framework to help Congress, the White House, and federal agency heads establish national transportation research and development priorities and coordinated research activities. This document presented (1) a vision of the transportation enterprise, (2) a likely transportation scenario for the year 2020, and (3) a set of national transportation goals and measures encompassing safety, security, environmental quality and energy efficiency, economic productivity, and accessibility and mobility. It took a four-tiered approach consisting of (1) strategic planning and assessment, (2)

¹⁰ Executive Office of the President, Office of Science and Technology Policy, “National Aeronautics R&D Goals: Technology for America’s Future,” February 1987, <http://www.aero-space.nasa.gov/docs/nstc87.htm> (accessed June 23, 2006).

¹¹ Executive Office of the President, National Science and Technology Council, Office of Science and Technology Policy, “Goals for a National Partnership in Aeronautics Research and Technology,” September 11, 1995, http://clinton1.nara.gov/White_House/EOP/OSTP/html/aero/cv-ind.html (accessed June 23, 2006).

strategic partnership initiatives, (3) ways to enable research, and (4) transportation education and training.¹²

In May of 1999, the NSTC released a new National Transportation Science and Technology Strategy that built on the first Strategy. It also used a four-tiered approach consisting of (1) strategic planning and assessment to support national transportation goals, (2) private-public technology partnerships, (3) ways to enable research, and (4) education and training. The document identified strategic goals encompassing safety, mobility and access, economic growth and trade, the human and natural environment, and national security that would be necessary to build the transportation system of the 21st century. The goals were to:

- Promote the public health and safety by working toward the elimination of transportation-related deaths, injuries, and property damage;
- Shape America's future by ensuring a transportation system that is accessible, integrated, and efficient, and that offers flexibility of choices;
- Advance America's economic growth and competitiveness domestically and internationally through efficient and flexible transportation;
- Protect and enhance communities and the natural environment affected by transportation;
- Advance the nation's vital security interests by ensuring that the transportation system is secure and available for defense mobility and that our borders are safe from illegal intrusion.¹³

¹² Executive Office of the President, National Science and Technology Council, "Transportation Science and Technology Strategy," September 1997, pp. 10–25.

¹³ National Science and Technology Council, Committee on Technology, "National Transportation Science and Technology Strategy," April 1999, <http://www.volpe.dot.gov/infosrc/strtplns/nstc/strategy99/ntsts99-bw.pdf> (accessed June 26, 2006).

R&T Base

The R&T base focused on several critical disciplines.

Aerodynamics provided the technological base upon which vehicular advancements could be made throughout all speed regimes and aerospace vehicle classes. Research in aerodynamics was structured in a program encompassing theoretical analyses, numerical simulation, wind tunnel tests, instrumentation development, and selected flight research projects. A major emphasis was placed on developing and validating CFD methods and codes to advance the understanding and prediction of complex aerodynamic phenomena. The computational power of NASA's large Numerical Aerodynamic Simulator (NAS) supercomputer facility made such research possible.¹⁴

Propulsion system technology relied on a base of focused discipline research in the areas of internal fluid mechanics (IFM), advanced control concepts, and new instrumentation techniques. The scope of propulsion research included small turbine engines, powered-lift concepts in support of Advanced Short Takeoff and Vertical Landing (ASTOVL) aircraft configurations, and propulsion for supersonic cruise and hypersonic aircraft.¹⁵

In the area of **materials and structures**, NASA increasingly emphasized computational structural mechanics (CSM), optimization techniques, active flutter suppression, and advanced high-temperature materials research. This was because evolving material and structural

¹⁴ *NASA Aeronautics: Research and Technology, Program Highlights*, NP-129, p. 29.

¹⁵ *Ibid.*, p. 34.

requirements were permitting the development of new civil and military aeronautical vehicles with improved performance, durability, and economy.¹⁶

NASA's **information sciences and human factors** program contributed to new missions that stretched the pilots' capabilities, and integrated systems that demanded high-speed computational processing. New technologies in this area helped researchers understand, control, and optimize a new family of aeronautical vehicles, including high-performance aircraft that could maneuver at ultrahigh AoAs, safer transports, and future transatmospheric vehicles that were planned to operate routinely across the boundaries of the atmosphere and space.¹⁷

Fundamental computer science studies of new architectures and the algorithms needed to exploit the full power of computers were conducted at the Research Institute for Advanced Computer Science at Ames Research Center. These studies significantly accelerated the development of CFD, computational chemistry, and other disciplines.¹⁸

Flight systems focused on validating research in other areas through actual flight-testing of new components and systems. Such inflight validation was frequently achieved by using high-performance aircraft, often provided by the DOD under long-standing agreements with NASA, as test platforms. NASA used these aircraft primarily in flight research programs at Dryden Flight Research Center.¹⁹ The F-106 aircraft was flown with a leading-edge vortex flap to investigate low-speed handling qualities, stability and control, structural dynamics, and

¹⁶ *NASA Aeronautics: Research and Technology, Program Highlights*, NP-129, pp. 37–38

¹⁷ *Ibid.*, p. 40.

¹⁸ *Ibid.*, p. 42.

¹⁹ *Ibid.*, p. 43.

maneuver loads. Data were obtained to validate potential improvements in the lift/drag ratio, as well as improved stability, control, and maneuverability. A preproduction F-15A loaned to NASA by the U.S. Air Force was used in the Highly Integrated Digital Electronic Control (HIDEC) program to develop, demonstrate, and evaluate potential improvements in aircraft performance and mission effectiveness that were made possible by proper integration of the engine, inlet, and airframe systems.²⁰

The **investigation of atmospheric phenomena** critical to the operational safety of civil and military aircraft was an important part of NASA's aeronautical R&T program. Areas of special concern included storm hazards, lightning, gusts, turbulence, rain effects, icing, and windshear. In accordance with NASA's charter, safety-related research supported and was coordinated with the Federal Aviation Administration (FAA), which had primary responsibility for aircraft safety.²¹

Flight-test instrumentation activity was the only way to simultaneously duplicate specific combinations of variables, such as temperature, pressure, density, viscosity, and Reynolds number, that were representative of real atmospheric flight conditions.²² The goal of the flight-test instrumentation program was to significantly improve the efficiency of flight tests, increase the accuracy of flight data, and develop techniques for acquiring necessary information that was previously unobtainable during flight. NASA used existing prototype or production aircraft as

²⁰ *NASA Aeronautics: Research and Technology, Program Highlight*, NP-129, pp. 43–44.

²¹ *Ibid.*, p. 44.

²² "Reynolds number is named for the 19th century British engineer Osborne Reynolds. It is a flow-similarity parameter that describes forces acting on a body in motion with respect to the fluid in which it is immersed. The number is directly proportional to the size of the body and the density and relative speed of the fluid and inversely proportional to the viscosity of the fluid." From Alex Roland, *Model Research, volume 2* (Washington, DC: NASA SP-4103, 1985), pp. 509–510. Available at <http://history.nasa.gov/SP-4103/sp4103.htm> (accessed August 5, 2006).

test platforms for evaluating new flight-testing techniques and instrumentation. The F-104 aircraft, flown at Ames-Dryden, was used to determine the feasibility of using piloted aircraft rather than weather balloons to obtain more timely data on winds aloft before Space Shuttle launches.²³

Focused Systems Research

Focused systems R&T centered on subsonic transports, advanced rotorcraft technology, high-speed transport, hypersonic cruise/transatmospheric vehicles, and high-performance aircraft.

Efforts in the subsonic transport area focused on the technology needed to develop a new generation of fuel efficient, affordable aircraft and to improve the safety and productivity of the National Airspace System.²⁴ Key technology challenges involved reducing fuel consumption, viscous drag, and structural weight, and developing fully integrated flight-control and operating systems that would interface with a flexible and modernized National Airspace System.²⁵ During the decade, NASA reordered its research, shifting from an emphasis on systems such as propulsion to research corresponding to “pillars” and goals representing technical challenges (for example, improving safety). Consequently, oversight of some of the activities described below may have been moved from systems-level organizational elements to goal-oriented organizations. However, the actual focus of the research typically remained unchanged.

²³ *NASA Aeronautics: Research and Technology, Program Highlights*, NP-129, p. 45.

²⁴ The National Airspace System is America’s network of airspace, airport, air navigation facilities, air traffic control facilities, communication, surveillance and supporting technologies, and operating rules and regulations.

²⁵ *NASA Aeronautics: Research and Technology, Program Highlights*, NP-129, p. 6.

In the area of advanced rotorcraft technology, NASA's objective was to provide the validated technology of new rotorcraft with high-speed capabilities for civil and military applications and develop quiet, jet-smooth, highly automated rotorcraft, including tiltrotor aircraft. The technological challenges included

- reducing wing download in hover operations;
- reducing cruise drag in high-speed configurations;
- reducing external noise and airframe vibrations;
- reducing crew workload in performing complex piloting tasks;
- developing convertible propulsion systems for efficient cruise and takeoff operations;
- integrating new technologies in materials, controls, and aerodynamics into innovative configurations that would combine the vertical lift utility of the rotor with the high-speed capability of a fixed wing.²⁶

NASA's high-speed research efforts explored ways to develop future high-speed transport aircraft that would be economically competitive with long-haul subsonic aircraft, taking into account current environmental concerns about atmospheric impact, airport noise, and sonic booms. The atmospheric impact research included long-term atmospheric chemistry assessments and low-emission combustor research. Airport noise reduction research included investigations of alternative engine cycles and jet noise suppression technology to meet FAR 36-Stage III noise levels, the same levels attained by the quietest subsonic aircraft. Sonic boom reduction research

²⁶ *NASA Aeronautics: Research and Technology, Program Highlights*, NP-129, p. 7.

included analyzing and testing low sonic boom design options, as well as evaluating human response characteristics to define sonic boom acceptability criteria.²⁷

Hypersonic technology research focused on vehicle configuration studies, propulsion, and materials and structures. It merged aeronautics and space technologies that could potentially provide for a new class of flight vehicles ranging from hypersonic aircraft to a single-stage-to-orbit space transportation system. Key research involved the development of air-breathing propulsion system technology, horizontal takeoff, acceleration through the transonic and supersonic speed ranges, and sustained operation at hypersonic speeds, as exemplified in the NASP program that ended in 1995. The NASP program, which was jointly funded by the DOD and NASA, focused on developing a flight research vehicle to validate and demonstrate the integration of aeronautics and space technologies across the speed range from takeoff to orbital velocities.²⁸

NASA's high-performance aircraft research program was structured to develop and mature technologies that would have long-term military applications. Its objective was to develop technological options that would enable a new generation of fighter aircraft with improved maneuverability and agility, and capabilities for sustained supersonic cruise and short takeoff and vertical landing (STOVL). Important technological challenges included achieving effective post-stall flight at AoAs of about 60 degrees, increasing propulsion system thrust-to-weight ratios, and developing a STOVL capability within an efficient supersonic cruise vehicle.²⁹

²⁷ *NASA Aeronautics: Research and Technology, Program Highlights*, NP-129, pp. 7–8.

²⁸ *Ibid.*, p. 18.

²⁹ *Ibid.*, p. 8.

NASA's national facilities for aeronautical research were among the program's most important tools. During the 1990s, its wind tunnels continued their basic engineering mission of validating new aircraft designs and subsequent refinement of configurations. Additionally, wind tunnel validation of new theoretical concepts was an integral part of aerodynamic progress. Other facilities were used to check out aircraft components and assess how components and integrated systems interacted during operations.³⁰

Space

The overall goal of the space R&T program was to provide advanced technologies for future space missions. It achieved this by developing technical strengths in the engineering disciplines within NASA, industry, and academia, and performing critical technology validations to facilitate the transfer of new technology with a high level of confidence to future space missions. Marshall Space Flight Center was a "Center of Excellence" in NASA's Aerospace program for the mission areas of space propulsion and transportation system development. Langley Research Center (NASA's Center of Excellence for aerospace), Lewis Research Center, and Ames Research Center were also often lead centers in various space technology development activities.³¹

Space R&T activities during this decade were shaped partly by the recommendations of the Advisory Committee on the Future of the U.S. Space Program. In 1991, the Office of Aeronautics and Space Technology (OAST) developed an Integrated Technology Plan (ITP) for the civil space program. Its purpose was to serve as a strategic plan for the OAST space R&T

³⁰ National Aeronautics and Space Administration Office of Aeronautics and Space Technology, *NASA Aeronautics: Research and Technology, Program Highlights*, NP 159, [no date], c. 1992, pp. 64–65. Also Donald D. Baals and William R. Corliss, *Wind Tunnels of NASA* (Washington, DC: NASA SP-440, 1981), p. 146.

³¹ *Aeronautics & Space Transportation Technology: Three Pillars for Success, Annual Progress Report 1997–1998*, pp. 14, 74.

program and as a strategic planning framework for other NASA and national participants in advocating and conducting technology developments supporting future U.S. civil space missions.³² The plan named the organizations that would be the most responsible for planning and implementing the majority of government-led civil space missions: the Office of Space Science and Applications, the Office of Exploration, the Office of Space Flight, and the Office of Space Communications. It then identified several technology needs of these organizations. It recognized that many of the specific technologies identified as needs were common to several different users and their respective mission plans, differing in some cases only in the projected timing or performance requirements of specific technology program deliverables. The plan noted that while some technologies were very important to several users, so, in many cases, were the needs identified by only a single user that might enable a particular mission.³³ The ITP incorporated substantial changes in the processes, structure, and content of NASA's space R&T program. Major aspects of the processes recommended in the plan included using a technology-user-driven process to establish program content, using well-defined decision rules and evaluation criteria to establish program priorities, and creating an annual cycle for program planning that would involve both user office participation and external review of proposed plans. It identified "success" in the space R&T program as the incorporation of a technology into an operational mission.³⁴

³² *1991 Integrated Technology Plan for the Civil Space Program*, (Washington, DC: National Aeronautics and Space Administration, 1991), p. ii,

http://ntrs.nasa.gov/archive/nasa/casi.ntrs.nasa.gov/19920022390_1992022390.pdf (accessed June 27, 2006).

³³ *1991 Integrated Technology Plan for the Civil Space Program*, pp. 2-20–2-21,

http://ntrs.nasa.gov/archive/nasa/casi.ntrs.nasa.gov/19920022390_1992022390.pdf (accessed June 27, 2006).

³⁴ *Aeronautics and Space Report of the President, Fiscal Year 1991 Activities*, pp. 66–67.

The space R&T program consisted of two complementary program areas: the R&T base and focused projects. The R&T base program emphasized gaining knowledge and understanding of the fundamental aspects of phenomena in critical disciplines. This program was the foundation for developing new technologies, enhancing capabilities, and generating more highly mission-focused technology programs. Although they varied slightly during the decade, the basic disciplines studied were typically aerothermodynamics, space energy conversion, propulsion, materials and structures, space data and communications, information sciences, controls and guidance, human factors, spaceflight, and systems analysis. In 1993, the space communications R&T program was moved from the Office of Space Science and Applications and added to the R&T base. In addition, the R&T base supported the University Space Research program. This program supported interdisciplinary research centers, provided grants to individuals doing research on highly innovative space technology concepts directed toward far-term mission use, and funded advanced systems study courses at the senior and graduate levels to foster engineering design education and to supplement NASA's in-house efforts in advanced planning for space systems design.

Focused programs drew on requirements provided by potential users of a technology. They developed technologies for specific future applications and delivered products in the form of proven hardware, software, and design techniques and data. In general, they focused on improving access to space, performing exploration missions outside Earth's orbit, advancing space technology, and furthering proficiency in space robotics and automation.

The types and names of NASA's focused space R&T programs changed several times during the decade. Early in the decade, the two major focused space programs were the Civil Space Technology Initiative (CSTI) and the In-Space Technology Experiments Program (In-STEP). CSTI addressed current high-priority national and Agency needs aimed at advancing the state of technology. Elements within CSTI included automation and robotics, propulsion, vehicle, information technology, large structures and control, and high-capacity power. In-STEP played an important role in the transition of technology from research and development into flight systems. It began in 1990 and ended in 1993, when it was moved into the space R&T base. Both programs are discussed in more detail later in this chapter.

In 1993, the Office of Commercial Programs and the space R&T program of OAST were merged to create a new organization, the Office of Advanced Concepts and Technology (OACT). OACT was NASA's focal point for technology innovation and transfer. Its mission was to "pioneer innovative, customer-focused space concepts and technologies, leveraged through industrial, academic, and government alliances to ensure U.S. competitiveness and preeminence in space."³⁵ In 1994, to correspond with OACT's strategic goals, or thrusts, CSTI dropped its former structure and adopted the program areas of space science technology, planetary surface technology, transportation technology, space platforms technology, and operations technology.

Later in 1994, a major restructuring of OACT took place. The CSTI designation was dropped entirely and a new advanced space transportation program was established. It combined space transportation technology activities that were formerly split among several programs. These

³⁵ "Objectives and Justification," Fiscal Year 1994 Estimates, Office of Advanced Concepts and Technology, p. RD 7-2.

included space transportation, advanced transportation, the Solid Propulsion Integrity Program (SPIP), advanced launch technology, and single-engine Centaur technology. Other reconfigured programs included spacecraft and remote sensing, flight programs, space communications, advanced small-satellite technology, and space processing. In addition, OACT added programs that were formerly associated with the Office of Commercial Programs.

In the area of commercial programs, technology transfer supported the infrastructure and networks needed to transfer technology from NASA laboratories to U.S. industry. The industry technology program goal was to advance aerospace technologies in U.S. industry that had a high probability of leading to commercial products and applications, or to non-aerospace industry applications that might be important to NASA applications.

In August 1994, OACT was disbanded and the Office of Space Access and Technology (OSAT) was formed. OSAT took over many of the functions and programs of OACT. A primary change that occurred at OSAT's inception was its inclusion of expendable launch vehicle (ELV) services. However, in January 1996, ELV services were dropped from OACT and moved to the Office of Space Flight. Initially, OSAT's goals were to

- develop technology to revitalize access to space consistent with the National Space Transportation Policy;
- provide new and innovative space technologies to meet the challenges and lower the cost of future space missions;
- nurture and expand commercial space industries by proactively developing, demonstrating, and transferring NASA technology to aerospace and non-aerospace applications;

- provide successful, on-schedule ELV space launch services for all civil U.S. government missions at the best price and value possible.

In late 1994, in response to national space policy, NASA established the Reusable Launch Vehicle (RLV) Technology program to develop and flight-test experimental RLVs. This effort included a series of flight demonstrators: the Delta Clipper Advanced, X-33, and X-34 (discussed later in this chapter).

In 1997, NASA disbanded OSAT and recombined its aeronautics and space transportation technology activities and its commercial technology programs into a single organization, the Aeronautics and Space Transportation Technology Enterprise. The Space Transportation Technology program reflected efforts to develop and demonstrate next-generation technologies to enable the commercial launch industry to provide affordable and reliable access to space early in the 21st century.

OSAT was organized into three “pillars” with 10 technology goals as stated by the Office of Aeronautics and Space Transportation Technology.

Pillar One: Global Civil Aviation

- Reduce the aircraft accident rate by a factor of five within 10 years, and by a factor of 10 within 20 years.
- Reduce emissions of future aircraft by a factor of three within 10 years and by a factor of five within 20 years.

- Reduce the perceived noise levels of future aircraft by a factor of two from today's subsonic aircraft within 10 years, and by a factor of four within 20 years.
- While maintaining safety, triple the aviation system throughput, in all weather conditions, within 10 years.
- Reduce the cost of air travel by 25 percent within 10 years, and by 50 percent within 20 years.

Pillar Two: Revolutionary Technology Leaps

- Reduce the travel time to the Far East and Europe by 50 percent within 20 years, and do so at today's subsonic ticket prices.
- Invigorate the general aviation industry, delivering 10,000 aircraft annually within 10 years, and 20,000 aircraft annually within 20 years.
- Provide next-generation design tools and experimental aircraft to increase design confidence, and cut the development cycle time for aircraft in half.

Pillar Three: Access to Space

- Reduce the payload cost to low-Earth orbit by an order of magnitude, from \$10,000 to \$1,000 per pound, within 10 years.
- Reduce the payload cost to low-Earth orbit by an additional order of magnitude, from \$1,000s to \$100s per pound, by 2020.³⁶

³⁶ *Aeronautics & Space Transportation Technology; Three Pillars for Success: Turning Goals Into Reality, Annual Progress Report 1997–1998*, pp. 2–6, <http://www.aeronautics.nasa.gov/docs/3pillars2.pdf> (accessed June 22, 2006).

Pillars One and Two related primarily to aeronautical R&T. Pillar Three focused largely on space R&T.

Exploration

NASA's Office of Exploration was formed in June 1987 to meet the need for specific activities that would support the long-term goal of expanding human presence and activity beyond Earth's orbit in the solar system. It was believed that a move in that direction could energize the U.S. civilian space program and stimulate the development of new technologies.³⁷ Activities focused on identifying viable alternatives and recommending approaches to human exploration of the solar system. Beginning in 1988, four case studies along three "pathways"—the human expeditions pathway, the science outpost pathway, and the evolutionary expansion pathway—were carried out:³⁸

- Human Expedition to Mars: This case study, in the human expeditions pathway, emphasized a quick, visible, nonpermanent effort to use current technologies and knowledge to achieve the first human exploration of Mars. Over three missions, the first human explorers of the Martian surface would capture early leadership in piloted interplanetary exploration. The crew would scientifically explore the local terrain and formations, put in place long-lived geophysical instruments, and collect samples for return to Earth. The Martian moons, Phobos and Deimos, would also be explored.³⁹

³⁷ *Aeronautics and Space Report of the President, 1988 Activities* (Washington, DC: National Aeronautics and Space Administration, 1990), p. 66.

³⁸ "Beyond Earth's Boundaries: Human Exploration of the Solar System in the 21st Century, 1988 Annual Report to the Administrator," NASA Office of Exploration, November 1988, synopsis in David Portree, *Romance to Reality*, Mars Institute, <http://www.marsinstitute.info/rd/faculty/dportree/rtr/8811-01.html> (accessed June 9, 2006).

³⁹ *Aeronautics and Space Report of the President, 1988 Activities*, p. 67. Also *Aeronautics and Space Report of the President, 1989–1990 Activities* (Washington, DC: National Aeronautics and Space Administration, 1991), p. 58.

- Lunar Observatory—Lunar Evolution: This case study, in the science outpost pathway, examined ways to gradually consolidate a permanent astronomical observatory on the Moon, allowing life-sciences research and providing scientific opportunities in astronomy, geology, physics, and other fields. This lunar observatory would include large, more stable instruments and arrays that enabled astronomers to avoid the limitations of observing objects from Earth or from Earth orbit, and to obtain better (by orders of magnitude) observations. The outpost would consist of optical telescope arrays, stellar monitoring telescopes, and radio telescopes, enabling near-complete coverage of the radio and optical spectra. It would also serve as a base for geological exploration and for a modest life-sciences laboratory.⁴⁰
- Lunar Outpost to Early Mars Evolutions: This case study, in the evolutionary expansion pathway, sought to build a capability leading to a nearly self-sufficient, sustained human presence beyond low-Earth orbit. It aimed to build a “bridge between worlds” in the inner solar system so as to establish a human presence on the Moon and Mars. An underlying goal was to learn to live off the lunar land and eventually also the Martian land. The evolutionary approach would drive broad advances in technology, evolutionary experience in outpost development and habitation, and use of local resources, and the development of facilities to stimulate further growth.⁴¹
- Human Expedition to Phobos: This case study, in the human expeditions pathway, combined a human expedition to Phobos with rovers operated by a crew flying in Mars orbit. These first human travelers to the Martian moon would explore, conduct resource surveys, and establish a science station. It would also provide opportunities to conduct enhanced robotic exploration of Mars itself from Mars orbit using teleoperated rovers, penetrators, balloons,

⁴⁰ *Aeronautics and Space Report of the President, 1989–1990 Activities*, p. 58. Also *Aeronautics and Space Report of the President, 1988 Activities*, p. 67.

⁴¹ *Aeronautics and Space Report of the President, 1988 Activities*, p. 68.

and sample collectors, and to return samples of Mars and Phobos to Earth for detailed analysis.⁴²

The results of the 1988 study effort were released in a report titled “Beyond Earth’s Boundaries: Human Exploration of the Solar System in the 21st Century.” One conclusion of the report was that the U.S. must begin detailed research, technology development, and concentrated studies independently of which future exploration endeavor was chosen. It also emphasized the importance of near-term investments and studies that kept promising options and opportunities open. The report noted that the strategy must effectively build on current programs, keep the demand for exploration-unique resources at a modest level, and still preserve the capability to act in the first decade of the 21st century.⁴³

In 1989, the Office of Exploration continued to analyze the lunar evolution, Mars evolution, and Mars expedition case studies. It evaluated requirements for human exploration of the Moon and Mars in areas such as Earth-to-orbit transportation, planetary transfer, and planetary surface operations.⁴⁴

The Pathfinder program, later called the Exploration Technology program, began in 1989. The goal of this focused technology program was to strengthen the “technology foundation of the civil space program and the nation’s technology leadership.” It was considered a prerequisite to any decision to proceed with ambitious civil space missions. Initially, the program was organized into the areas of surface exploration, in-space operations, humans in space, and space transfer.

⁴² *Aeronautics and Space Report of the President, 1988 Activities*, pp. 66–67.

⁴³ *Ibid.*, p. 68.

⁴⁴ *Aeronautics and Space Report of the President, 1989–1990 Activities*, pp. 57–58.

Additionally, mission studies were conducted to support “the detailed formulation of mission requirements and technology options.”⁴⁵ In 1991, the areas of lunar and Mars science, information systems and automation, nuclear propulsion, and innovative technologies and systems analysis were added. In 1993, Exploration Technology activities moved to the planetary surface technology and transportation technology areas of the CSTI program; other exploration activities moved to the new Office of Exploration.

On July 20, 1989, the 20th anniversary of the Apollo 11 Moon landing, President George Bush announced plans for a Space Exploration Initiative (SEI). In his speech, he looked ahead to the planned Space Station Freedom and called first for the establishment of a permanent human presence on the Moon and then a human mission to Mars. He asked Vice President Dan Quayle to lead the National Space Council (NSC) in determining the money, workforce, and technologies needed to carry out these missions.⁴⁶ The President’s remarks added details to the goal stated in the 1988 Presidential Directive on National Space Policy (“to expand human presence and activity beyond Earth orbit into the solar system”).⁴⁷ No cost for the program was mentioned by the President, but Richard Darman, Director of the Office of Management and Budget, stated at a press conference the same day that fulfilling the goals would cost \$400 billion

⁴⁵ “Space Research and Technology,” Office of Aeronautics and Space Technology, Fiscal Year 1989 Estimates, p. RD 15-70. Also “Space Research and Technology,” Office of Aeronautics and Space Technology, Fiscal Year 1990 Estimates, p. RD 14-30.

⁴⁶ “Remarks on the 20th Anniversary of the Apollo 11 Moon Landing,” July 20, 1989, <http://bushlibrary.tamu.edu/research/papers/1989/89072000.html> (accessed June 8, 2006). Also Steve Dick, “Summary of Space Exploration Initiative,” <http://history.nasa.gov/seisummary.htm> (accessed June 8, 2006).

⁴⁷ “Report of the 90-Day Study on Human Exploration of the Moon and Mars,” National Aeronautics and Space Administration, November 1989, p. 1-1, http://history.nasa.gov/90_day_study.pdf (accessed June 6, 2006).

over 30 years.⁴⁸ The new national space policy released on November 2, 1989, called for the establishment of “a permanently manned presence in space.”⁴⁹

On July 26, NASA Administrator Richard Truly and Assistant Administrator for Exploration Frank Martin briefed NASA employees on the new initiative. On August 4 at NASA’s Johnson Space Center, Martin launched the 90-Day Study to outline NASA’s plan for accomplishing the Bush program.

The Bush initiative immediately preempted other planning efforts, and many NASA employees were reassigned to a team called the Precursor Task Team (PTT). Its goal was to develop a set of robotic Moon and Mars missions to pave the way for piloted missions that would follow. The PTT based its proposed missions on requirements from the Mission and Systems Engineering element of the Johnson Space Center (JSC) Lunar/Mars Exploration Planning Office and the NASA Headquarters (HQ) Office of Exploration, many of which were developed during four workshops held in late August. The team briefed the HQ Office of Space Science and Applications on its plan on September 25, 1989. The 90-Day Study team, chaired by JSC Director Aaron Cohen, incorporated a streamlined version of the PTT plan into its November report titled “Report of the 90-Day Study on Human Exploration of the Moon and Mars.”⁵⁰

⁴⁸ Marcia S. Smith, “Space Exploration: Overview of President Bush’s ‘Vision for Space Exploration,’ and Key Issues for Congress,” CRS Report for Congress, RS21720, Congressional Research Service, Library of Congress, p. CRS-4, <http://fpc.state.gov/documents/organization/41129.pdf> (accessed June 8, 2006).

⁴⁹ “National Space Policy Directive (NSPD)-1,” National Space Policy, November 2, 1989, www.fas.org/spp/military/docops/national/nspd1.htm (accessed March 1, 2005).

⁵⁰ “A Robotic Exploration Program: In Response to the NASA 90-Day Study on Human Exploration of the Moon and Mars,” JPL D-6688, Jet Propulsion Laboratory, California Institute of Technology, December 1, 1989, synopsis in Portree, *Romance to Reality*, <http://www.marsinstitute.info/rd/faculty/dportree/rtr/8912.html> (accessed June 8, 2006).

The report drew from much of NASA's exploration work conducted over the previous years. It examined five reference approaches to human exploration of the Moon and Mars, each of which had a particular emphasis: (1) balance and speed, (2) the earliest possible landing on Mars, (3) reduced logistics from Earth, (4) schedule adapted to Space Station *Freedom*, and (5) reduced scale. The findings provided reference material regarding potential requirements in technology and other areas. The report also examined the scientific opportunities and other potential benefits. It did not contain specific recommendations or any estimates of total mission costs.⁵¹ A separate cost summary issued at the same time as the study estimated the SEI's long-term cost at approximately \$500 billion, spread out over 20 to 30 years.⁵² NASA Administrator Truly briefed the NSC's Blue Ribbon Panel on the report on November 29, 1989. Vice President Quayle asked the National Academy of Sciences to assess the scope and content of the NASA study, as well as alternative approaches and technology issues. The Academy largely concurred with the NASA study, although the White House, as represented by the NSC, did not. The staff director of the NSC, Mark Albrecht, stated that the goal of the SEI was to take an innovative approach, to do things "better" than before. Council members pointed to the Strategic Defense Initiative (SDI) as an example of this new approach.⁵³

On December 21, 1989, Truly announced he would merge the Office of Exploration into OAST to form the Office of Aeronautics, Exploration, and Space Technology to "ensure tight

⁵¹ *Aeronautics and Space Report of the President, 1989–1990 Activities*, p. 58. Also "Report of the 90-Day Study on Human Exploration of the Moon and Mars," National Aeronautics and Space Administration, cover news release, "NASA Moon/Mars Database Report," November 20, 1989, http://history.nasa.gov/90_day_study.pdf (accessed June 6, 2006).

⁵² "Report of the 90-Day Study on Human Exploration of the Moon and Mars; Cost Summary," November 1989, p. 3, http://history.nasa.gov/90_day_cost_summary.pdf (accessed June 20, 2006).

⁵³ Steve Dick, "Summary of Space Exploration Initiative," <http://history.nasa.gov/seisummary.htm> (accessed June 8, 2006). Also Howard E. McCurdy, *Faster, Better, Cheaper: Low-Cost Innovation in the U.S. Space Program* (Baltimore, MD: Johns Hopkins University Press, 2001), pp. 45–46.

coordination in the creation of plans for human exploration of the solar system and the actual development of new technologies required to accomplish the goal.”⁵⁴ The merger was completed at the end of February 1990.⁵⁵ The organization incorporated the Exploration Mission Studies program.

On February 16, 1990, President Bush approved the following policy for the SEI:

- It would include lunar and Mars program elements and robotic and human science missions.
- The near-term focus would be on technology development, with an emphasis on new or innovative approaches and technology with the potential to make a major impact on cost, schedule, and/or performance.
- Mission, concept, and system analysis studies would be conducted in parallel with technology development.
- A baseline program architecture would be selected after several years of defining two or more reference architectures while developing and demonstrating broad technologies.
- NASA would be the principal implementing agency while the Department of Defense and the Department of Energy would have major roles in technology development and concept definition.⁵⁶

In March 1990, President Bush announced his intention to enter discussions with Europe, Canada, Japan, the Soviet Union, and other nations in an effort to obtain international support for the program.⁵⁷ However, he was unsuccessful in garnering the support of other nations.⁵⁸

⁵⁴ “NASA To Combine Exploration and Technology Organizations,” *NASA News Release* 89-185, December 21, 1989, NASA History Division folder 16436, Historical Reference Collection, NASA Headquarters, Washington, DC.

⁵⁵ *Astronautics and Aeronautics, 1986–1990; A Chronology* (Washington, DC: NASA SP-4027, 1997), p. 255.

⁵⁶ *Aeronautics and Space Report of the President, 1989–1990 Activities*, p. 58.

On May 11, 1990, at a commencement speech at Texas A&I University in Kingsville, Texas, President Bush announced his belief that humans would stand on Mars by July 20, 2019, “before Apollo celebrates the 50th anniversary of its landing on the moon.”⁵⁹

The SEI was intended to be a national effort and consequently in 1990 and 1991, NASA executed agreements with other federal agencies. In July 1990, it signed a memorandum of understanding (MOU) with the DOE to provide the necessary framework for collaboration between NASA and DOE in implementing SEI. Collaboration would take the form of information exchange and coordination of research and development activities.⁶⁰ In January 1991, NASA and the National Science Foundation signed a memorandum of agreement covering potential research activities in Antarctica that would benefit future SEI missions. Potential Antarctic activities included research into the effects of long-duration isolation and the conduct of scientific investigations in hostile environments.⁶¹ In August 1991, NASA and DOD agreed to collaborate in the areas of information exchange and coordination of research and development activities.⁶²

⁵⁷ The White House, Office of the Press Secretary, “Statement by Press Secretary Fitzwater on International Cooperation in the President's Space Exploration Initiative” March 30, 1990, <http://bushlibrary.tamu.edu/research/papers/1990/90033004.html> (accessed June 20, 2006).

⁵⁸ Steve Dick, “Summary of Space Exploration Initiative,” <http://history.nasa.gov/seisummary.htm> (accessed June 8, 2006).

⁵⁹ The White House, Office of the Press Secretary, “Remarks by the President in Texas A&I University Commencement Address,” May 11, 1990, <http://bushlibrary.tamu.edu/research/papers/1990/90051100.html> (accessed June 20, 2006).

⁶⁰ *Memorandum of Understanding Between the National Aeronautics and Space Administration and the Department of Energy*, July 9, 1990.

⁶¹ *Memorandum of Agreement Between the National Science Foundation and the National Aeronautics and Space Administration on Antarctic Activities*, January 23, 1991. Also *Aeronautics and Space Report of the President, Fiscal Year 1991 Activities* (Washington, DC: National Aeronautics and Space Administration, 1992), p. 68.

⁶² *Memorandum of Understanding Between the National Aeronautics and Space Administration and the Department of Defense*, August 21, 1991.

At the request of Vice President Quayle, in the summer of 1990, NASA began a nationwide search for new and innovative concepts and technologies for SEI “to ensure that all reasonable space exploration alternatives” had been evaluated before the program began. In August 1990, the Vice President and NASA Administrator Truly chartered the SEI Synthesis Group, chaired by former astronaut Thomas Stafford, to review inputs from thousands of individuals and organizations inside and outside NASA. In June 1991, the group distributed 40,000 copies of its report, titled *America at the Threshold*. It outlined four SEI architectures based on a number of technical strategies, including developing a heavy-lift launch capability, limiting on-orbit assembly, developing nuclear technologies, using the Moon as a testbed for Mars, using the same systems and operations for the Moon and Mars, using a complementary mix of human and robotic resources, and emphasizing technologies with terrestrial applications.⁶³ The major objectives of the architectures were to

- explore Mars and provide scientific returns, using the Moon as preparation for the Mars mission;
- perform exploration and scientific activities using complementary human and robotic missions to obtain balanced scientific returns from both the Moon and Mars;
- establish a permanent human presence on the Moon along with exploring Mars, providing terrestrial spinoffs to improve life on Earth and increasing knowledge of the solar system and humankind;
- make maximum use of available resources to directly support the space exploration missions, and develop a large class of available resources for a broader range of transportation, habitation, life sciences, energy production, construction, and other long-term activities to

⁶³ *America at the Threshold: America's Space Exploration Initiative*, Report of the Synthesis Group on America's Space Exploration Initiative, May 1991, p. 32. Also *America at the Threshold*, summary in Portree, *Romance to Reality*, Mars Institute, <http://www.marsinstitute.info/rd/faculty/dportree/rtr/9105.html> (accessed June 20, 2006).

reduce the direct expense of travel to the Moon and Mars and build toward establishing self-sufficient, long-duration space bases, and eventually return energy and resources to Earth.⁶⁴

Around the same time, in August 1990, President Bush established an advisory committee, headed by Norman Augustine, to make recommendations on the future of the U.S. space program. In its wide-ranging report, issued in December 1990, the committee recognized the importance of long-term human exploration and shared the President's view that Mars was the "long-term magnet for the manned space program." But it also stated that "human exploration of Mars should be tailored to the availability of funding, rather than adhering to a rigid schedule" and could be "spread over many years."⁶⁵ It emphasized that if funding could not be provided at a sufficient level, the exploration program should be delayed. The committee also recommended that an associate administrator for exploration be put in charge of both robotic and human exploration of the Moon and Mars. President Bush ordered NASA to implement these recommendations, and in October 1991 the Agency established a new Office of Exploration, headed by Michael Griffin, primarily to plan and execute the President's initiative.⁶⁶

Because of conflicting priorities for federal funds, NASA initially planned two precursor missions to provide resource, terrain, and gravity maps for later missions. It also initiated studies relating to lunar exploration. In accordance with the National Space Policy Directive issued by

⁶⁴ *America at the Threshold: America's Space Exploration Initiative*, pp. 34–52.

⁶⁵ Advisory Committee on the Future of the U.S. Space Program, *Report of the Advisory Committee on the Future of the U.S. Space Program*, December 1990, p. 6.

⁶⁶ Steve Dick, "Summary of Space Exploration Initiative," <http://history.nasa.gov/seisummary.htm> (accessed June 8, 2006). An earlier Office of Exploration, established in 1987, had been folded into the Office of Aeronautics and Space Technology in 1989 to form the Office of Aeronautics, Exploration, and Technology.

President Bush on March 13, 1992, NASA, as the principal implementing agency for SEI, began discussions with the DOD and DOE about executing the policy directive.⁶⁷

The Office of Exploration issued a draft Space Exploration Initiative Strategic Plan, “Building Tomorrow’s Program Today,” on May 22, 1992. It reflected a “firm commitment to a lunar return” and presented “an ambitious though plausible schedule for SEI, outlining a plan for human exploration of the Moon before the year 2000.”⁶⁸ According to the plan’s authors, the plan was based on three strategic themes: it was evolutionary, it was economically sound, and it required “excellence in management.”⁶⁹ The plan emphasized the importance of proceeding in a way that would reflect the current constrained budgetary environment, and of “doing the right things the right way.” It outlined NASA’s efforts to determine the needs of the scientific community and obtain the participation of other federal agencies, and its intent to use innovative procurement approaches. The Agency’s near-term exploration strategy was to “start small: to develop and conduct small-scale, robotic, automated precursor missions designed to fill the gaps in...scientific and technological knowledge.” The near-term program plan called for developing a resource and a terrain/gravity mapper and using a robotic lander on the lunar surface as preparatory steps for longer-term missions.⁷⁰ Essential initial flight elements and elements of the first surface lunar outpost were sketched out with a timetable extending through 1997, as well as

⁶⁷ “Space Exploration Initiative,” NSPD-6, March 13, 1992, <http://www.fas.org/spp/military/docops/national/nspd6.htm> (accessed June 20, 2006).

⁶⁸ Margaret G. Finarelli, memo to NASA Chief of Staff, Office of the Administrator, “SEI Strategic Plan,” May 22, 1992.

⁶⁹ NASA Office of Exploration, “Space Exploration Initiative Strategic Plan: Building Tomorrow’s Program Today,” May 1992, p. 2.

⁷⁰ “Space Exploration Initiative Strategic Plan: Building Tomorrow’s Program Today,” pp. 6–7.

an exploration program planning timeline up to 2020 (see figure 3-1). New technologies and advanced development activities were also identified.⁷¹

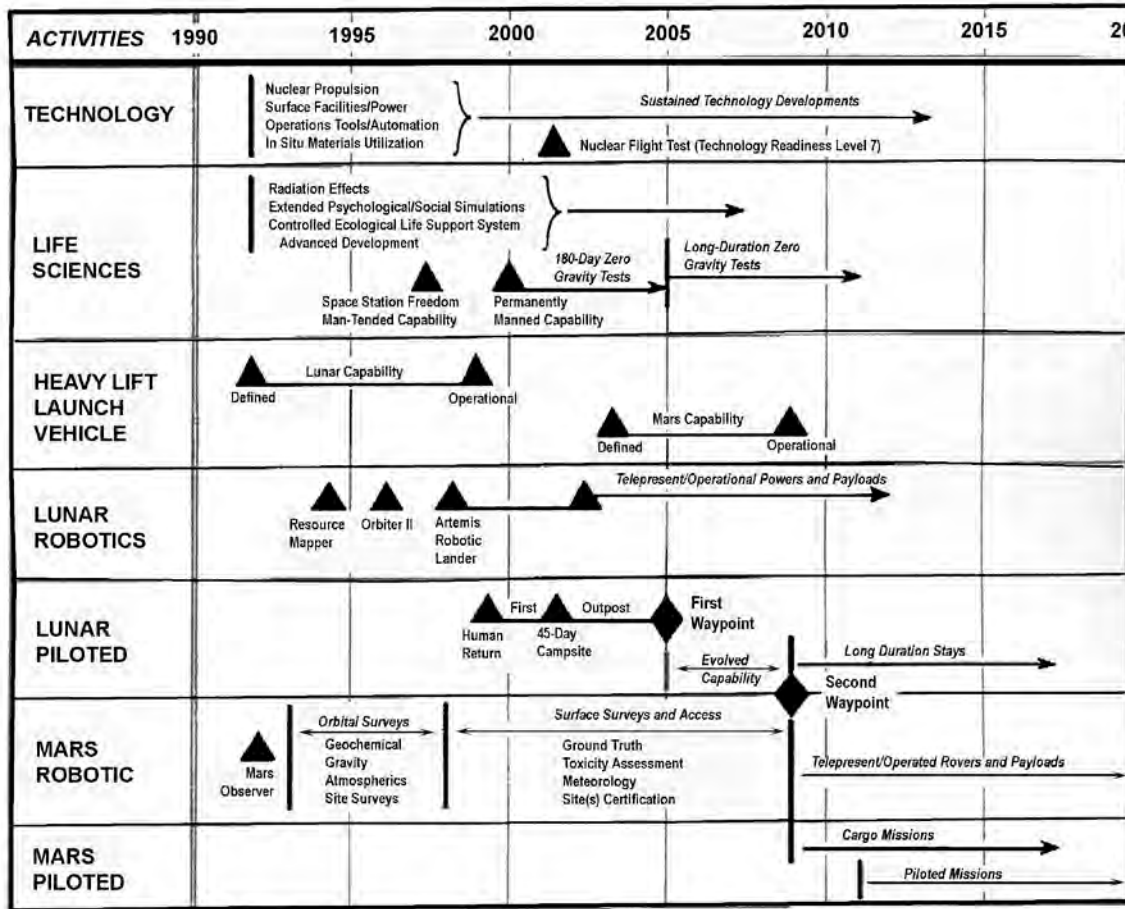

Figure 3-1. Exploration program planning timelines from the Space Exploration Initiative Strategic Plan, May 1992.

The initiative received extensive publicity, but it had been announced during a period when Congress was attempting to cut government spending to reduce the federal deficit. Congress did not view the initiative favorably, and even though the National Academy of Sciences had largely concurred with the NASA study, reactions to NASA’s plan by both the White House and Congress were hostile, primarily because of the cost estimate. In April 1992 the President

⁷¹ “Space Exploration Initiative Strategic Plan: Building Tomorrow’s Program Today,” pp. 8–15.

brought in a new NASA Administrator—Daniel Goldin, a proponent of “faster, better, cheaper” missions—who witnessed the demise of the exploration program. Congress repeatedly rebuffed NASA’s efforts to gain support for the plan. Funding for SEI was requested in the fiscal year (FY) 1991, 1992, and 1993 budgets, though what constituted “SEI funding” changed significantly during those years. For SEI in FY 1991, NASA requested \$953 million. The FY 1991 NASA authorization bill approved almost full funding, but the appropriations bill essentially eliminated it. Congress subsequently allowed NASA to reprogram \$37 million into SEI for FY 1991. For FY 1992, NASA requested \$94 million. Congress approved \$32 million. For FY 1993, \$64 million was requested. The FY 1993 NASA authorization bill approved approximately half of that, and the appropriations bill essentially eliminated all funding.⁷²

By early 1993, under the new Clinton administration, it became apparent that President Bush’s SEI would not go forward. In an Agency reorganization, the functions of NASA’s Office of Exploration were absorbed into the Office of Space Science. In President Clinton’s 1996 National Space Policy, human exploration was officially removed from the national agenda.

Management of NASA’s Aeronautics and Space R&T and Exploration Programs

Phase I (1989–1991)

Until February 1990, NASA managed both its aeronautics and space R&T programs under a single organization called the Office of Aeronautics and Space Technology (OAST, designated Code R within NASA). William F. Balhaus, Jr., served as the acting Associate Administrator of

⁷² Marcia S. Smith, “Space Exploration: Overview of President Bush’s ‘Vision for Space Exploration,’ and Key Issues for Congress,” CRS Report for Congress, RS21720, Congressional Research Service, Library of Congress, pp. CRS-4–CRS-5, <http://fpc.state.gov/documents/organization/41129.pdf> (accessed June 8, 2006). The FY 1991 Authorization Bill became P.L. 101-611. The FY 1991 Appropriations Bill became P.L. 101-507. The FY 1993 Authorization Bill became P.L. 102-588. The FY 1993 Appropriations Bill became P.L. 102-389.

OAST from February 1988 through April 1989, and Robert Rosen was Deputy Associate Administrator. In April 1989, Rosen became acting Associate Administrator. At the start of 1989, the divisions within OAST and their heads were as follows:

- Aeronautics: Cecil Rosen III (acting)
- Space: Frederick Povinelli
- NASP Office: Duncan E. McIver
- Propulsion, Power, and Energy: Gregory Reck
- Aerodynamics: Paul Kutler (acting)
- Information Sciences and Human Factors: Lee Holcomb
- Flight Projects: Jack Levine
- Aerodynamics: Paul Kutler (acting)
- Materials and Structures: Samuel Venneri
- Institutions: Martin Stein
- Resources and Management Systems Office: Edmund L. Sanchez

In 1989, Lana N. Crouch became acting Director of the Space Division, replacing Povinelli, and L. Michael Weeks became acting Director of the NASP Office, replacing McIver. Gregory Reck also became Director of the Mars Initiative Technology Team. In October 1989, Arnold Aldrich replaced Robert Rosen as Associate Administrator.

During the same period, NASA managed the exploration initiative through the Office of Exploration (designated Code Z within NASA), which had been established in 1987. Code Z was

the lead NASA organization for implementing President Bush's SEI.⁷³ At the start of 1989, Code Z was headed by Associate Administrator Franklin D. Martin and Deputy Assistant Administrator Douglas O'Handley. Jimmy Underwood headed the Technology and Infrastructure Division, Ivan Bekey was acting Director of the Mission Studies Division, and Carl Pilcher was acting Director of Science Studies. The position of Director of Special Projects was vacant.

On December 21, 1989, NASA Administrator Truly announced his intent to merge the Office of Exploration into OAST. The new organization, called the Office of Aeronautics, Exploration, and Technology, would combine analysis of exploration mission alternatives with innovative technologies. Truly stated that it would encourage "tight coordination" between planning for human exploration of the solar system and developing the new technologies required to accomplish that goal.⁷⁴

Truly announced the merger's completion on February 28, 1990. The new organization was headed by Aldrich. The Deputy Associate Administrator was Robert Rosen, and the Assistant Associate Administrator for Exploration was Franklin Martin, subordinate to the Code R associate administrator (see figure 3-2). The division heads were as follows:

- Aeronautics: Cecil C. Rosen III
- Space Technology: Lana M. Couch (acting)
- Institutions: Martin Stein
- Resources and Management Systems Office: Glenn C. Fuller

⁷³ "Space Exploration Initiative," http://www.fas.org/nuke/space/c07sei_1.htm (accessed June 2, 2006).

⁷⁴ *Astronautics and Aeronautics: A Chronology, 1986–1990* (Washington, DC: NASA-SP 4027, 1997), p. 255. Also "NASA To Combine Exploration and Technology Organizations," *NASA News Release 89-185*, December 21, 1989, NASA History Division folder 16436, Historical Reference Collection, NASA Headquarters, Washington, DC.

- NASP Office: H. Lee Beach, Jr. (acting)
- Information Sciences and Human Factors: Lee B. Holcomb
- Aerodynamics: Louis J. Williams
- Materials and Structures: Samuel Venneri
- Propulsion, Power and Energy: Gregory Reck
- Flight Projects: Jack Levine
- Space Exploration Office: Vacant

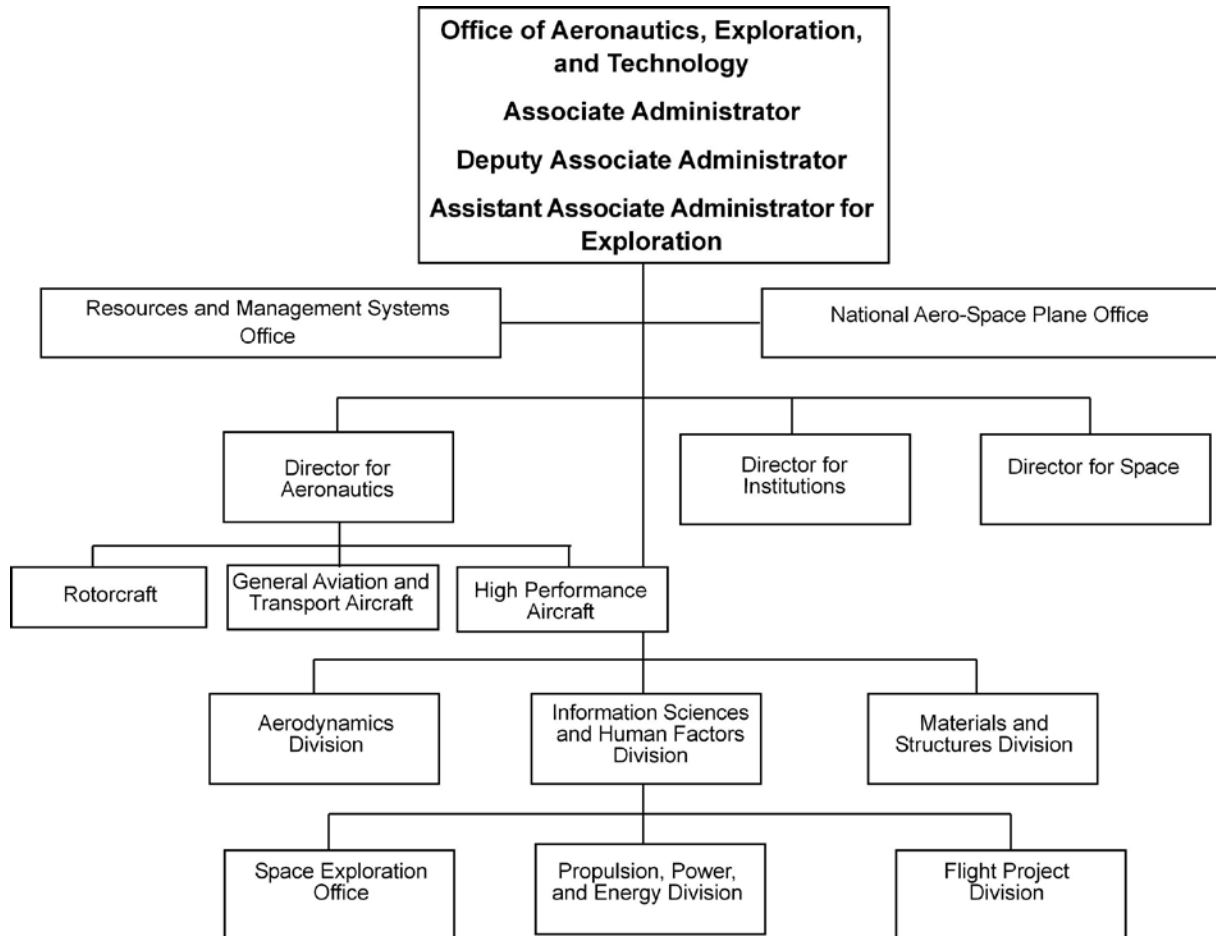

Figure 3-2. Office of Aeronautics, Exploration, and Technology, 1990–1991 (Derived from NASA Aeronautics: Research and Technology, Program Highlights, NP-129).

In early 1991, Mark K. Craig took the position of acting Director of the Space Exploration Office and Earl E. VanLandingham became Director of the Propulsion, Power, and Energy Division.

In December 1990, the Augustine Committee issued a report on the future of NASA. In response to the report, which recommended the establishment of an office headed by an associate administrator for exploration, in August 1991, NASA reestablished the Office of Exploration (this time designated Code X within NASA).⁷⁵ Truly appointed Michael Griffin, a recruit from the Defense Department's Strategic Defense as Associate Administrator to direct, integrate, and oversee activities involving NASA's exploration goals, including program, technical, and fiscal management for matters relating to the office.⁷⁶ On October, Jay H. Greene was appointed Deputy Associate Administrator for the Exploration Office. The Space Exploration Division was removed from the Office of Aeronautics, Exploration, and Technology (Code R), which was again named the Office of Aeronautics and Space Technology (OAST). Richard 'Pete' H. Petersen became its head in December (see figure 3-3).⁷⁷

⁷⁵ Advisory Committee on the Future of the U.S. Space Program, *Report of the Advisory Committee on the Future of the U.S. Space Program*, December 1990, <http://www.hq.nasa.gov/office/pao/History/augustine/racfup1.htm> (accessed March 15, 2005).

⁷⁶ "NASA Associate Administrator for Exploration Appointed," *NASA News Release 91-139*, August 23, 1991, <ftp://ftp.hq.nasa.gov/pub/pao/pressrel/1991/91-139.txt> (accessed June 1, 2006).

⁷⁷ "New Associate Administrator for Aeronautics and Space Technology," Key Personnel Change, December 2, 1991, NASA History Division folder 16436, Historical Reference Collection, NASA Headquarters, Washington, DC.

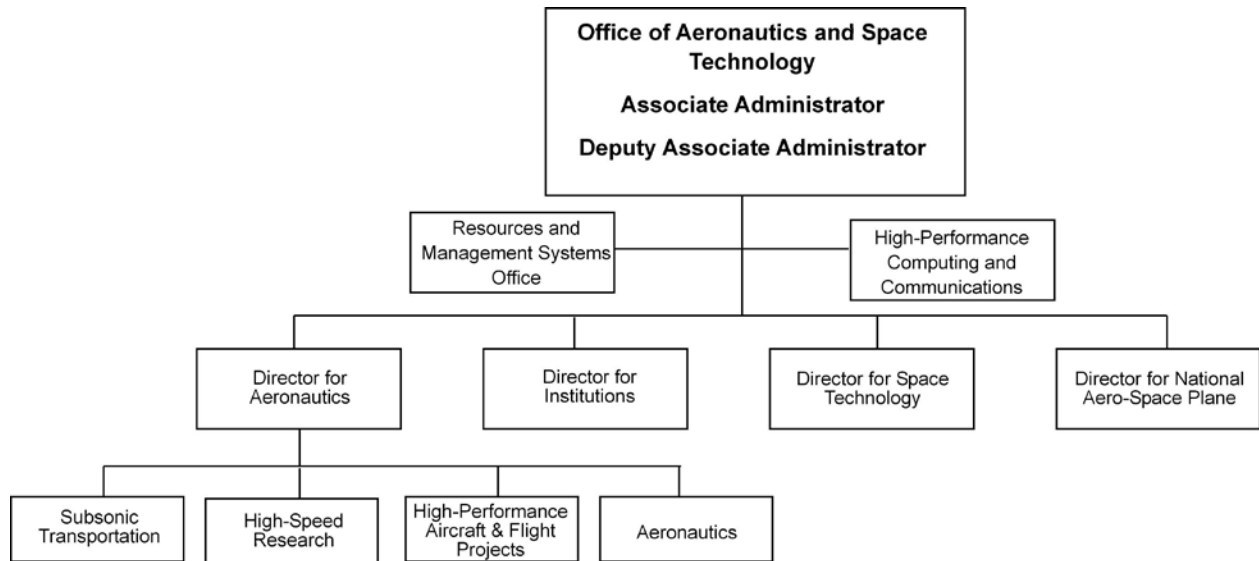

Figure 3-3. Office of Aeronautics and Space Technology, 1991 (Derived from NASA Aeronautics: Research and Technology, Program Highlights, NP 159).

Vincent L. Rausch was appointed Director of the NASP Directorate on December 4, 1991, effective January 12, 1992. Richard A. Reeves became Director for Institutions, Cecil Rosen remained as head of Aeronautics, and Reck remained as Director for Space Technology. The High Performance Computing and Communications Division, headed by Holcomb, replaced the Information Sciences and Human Factors Division. The Aerodynamics, Materials and Structures, and the Propulsion, Power and Energy Divisions were eliminated. The High Performance Aircraft Division and Flight Projects Division were merged into a single organization—the High Performance Aircraft and Flight Projects Office—in the Aeronautics Division. In July 1992, Robert Rosen left his position as Deputy Associate Administrator and relocated to Ames Research Center at Moffett Field, California.

Phase II (1992–1996)

On October 15, 1992, NASA Administrator Goldin announced a series of organizational changes to “improve management and bring focus to programs essential to America’s future.”⁷⁸ He stated that NASA needed a better balance of programs among subsonics, NASP hypersonics, and high-speed civil transport (HSCT). In addition, he noted that NASA needed to develop a strategic plan to ensure it had the proper facilities to keep the United States the aerospace industry’s world leader.

To meet these goals, OAST was restructured and divided. Pete Petersen became Special Assistant to the Administrator, charged with developing a comprehensive and integrated long-term plan to identify the critical facilities for aeronautics and space. Cecil Rosen, Director for Aeronautics, became acting Associate Administrator for the Office of Aeronautics (Code R). A new Office of Advanced Concepts and Technology (OACT, Code C within NASA) was formed in October 1992, replacing the Office of Commercial Programs and assuming many of the activities associated with space R&T (see figure 3-4). Commercial Programs became a division within OACT. OACT was to (1) function as a systems engineering team capable of judging the feasibility and cost of highly innovative ideas, (2) serve as NASA’s “front door” for businesses seeking NASA’s expertise in developing new ideas and technologies, (3) transfer technology into the commercial sector at a faster pace, and (4) stimulate commercial space activity.⁷⁹ Reck, who had led OAST’s Space Technology Division, was appointed acting Associate

⁷⁸ Daniel Goldin became NASA Administrator in April 1992.

⁷⁹ “Goldin Describes NASA’s New Commercialization Office,” *NASA News Release 92-201*, November 10, 1992, <ftp://ftp.hq.nasa.gov/pub/pao/pressrel/1992/92-201.txt> (accessed 2 June 2006).

Administrator, and Courtney Stadd was selected acting Deputy Associate Administrator for the new organization.⁸⁰

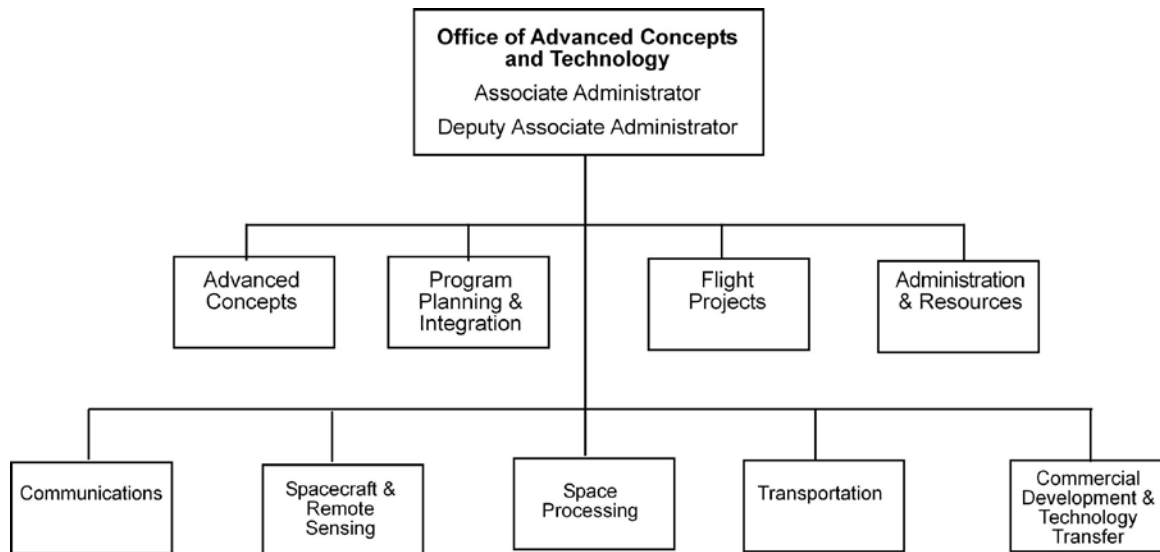

Figure 3-4. Office of Advanced Concepts and Technology (Derived from NASA HQ Telephone Directory).

On March 25, 1993, NASA Administrator Daniel Goldin announced the disbanding of the Office of Exploration and immediate absorption of its activities by the Office of Space Science. The Exploration Associate Administrator, Michael Griffin, was reassigned as NASA’s Chief Engineer.⁸¹

In January 1993, Wesley L. Harris was appointed Associate Administrator of the Office of Aeronautics, and Kristin A. Hessenius became Deputy Associate Administrator. New divisions

⁸⁰ “Goldin Announces Changes in NASA Organization to Focus and Strengthen Programs and Management,” *NASA News Release 92-172*, October 15, 1992, <ftp://ftp.hq.nasa.gov/pub/pao/pressrel/1992/92-172.txt> (accessed June 20, 2006).

⁸¹ “Exploration Effort Shifted to Office of Space Science,” *NASA News Release 93-54*, March 25, 1993, <ftp://ftp.hq.nasa.gov/pub/pao/pressrel/1993/93-054.txt> (accessed June 20, 2006).

were established from organizations that had formerly been part of the Aeronautics Division in OAST: Subsonic Transportation headed by Robert E. Whitehead, High-Speed Research headed by Louis J. Williams, High-Performance Aircraft and Flight Projects headed by Richard S. Christiansen (acting), and Strategy and Policy headed by John J. McCarthy. A new division—Critical Technologies, headed by Douglas Dwoyer (acting)—was also established.

The following list shows the divisions and acting directors of OACT:

- Advanced Communications: Robert L. Norwood
- Spacecraft and Remote Sensing: Samuel Venneri
- Flight Projects: Jack Levine
- Administration and Resources: Susan Fruchter
- Program Planning and Integration: Robert L. Norwood
- Transportation: Earl VanLandingham
- Space Processing: Richard H. Ott
- Commercial Development and Technology Transfer: Vacant

By October 1993, most of the division director positions in OACT had been filled. Venneri, Levine, Fruchter, Norwood, VanLandingham, and Ott had become directors of the Spaceflight and Remote Sensing, Flight Projects, Administration and Resources, Program Planning and Integration, Transportation, and Space Processing Divisions, respectively. Norwood continued as acting Director of Program Planning and Integration, James R. Ramler became acting Director of the Advanced Communications Division, and Reck stepped in as acting Director of the

Commercial Development and Technology Transfer Division. Late in the year, Thomas D. Brown became acting Director of the Administration and Resources Division, replacing Fruchter. In the Office of Aeronautics, the only change in late 1993 was the addition of John R. Facey as acting Director of Critical Technologies, replacing Dwoyer. In early 1994, changes made to the Office of Aeronautics included the appointment of Whitehead as Deputy Associate Administrator, Remer C. Prince as acting Director for Institutions, Ray V. Hood as acting Director of Subsonic Transportation, and Jay M. Henn as Director of Strategy and Policy. In the summer of 1994, Woodrow Whitlow, Jr., became Director of Critical Technologies.

A reorganization was announced on August 23, 1994 that merged OACT (along with the Office of Space Systems Development) into the new Office of Space Access and Technology (OSAT, Code X within NASA; see figure 3-5). John E. Mansfield was selected as the new NASA Associate Administrator for OSAT, and Reck became the Deputy Associate Administrator (effective September 6, 1994). A number of divisions and individuals moved from OACT to the new organization. The divisions and their directors were as follows:

- Flight Integration Office: Jack Levine
- Advanced Concepts Senior Executive: Ivan Bekey
- Launch Vehicles Office: Charles Gunn
- Commercial Development and Technology Transfer: Robert L. Norwood
- Spacecraft Systems: Samuel Venneri
- Space Processing: Edward A. Gabris
- Management Operations: Martin Stein
- Space Transportation: Vacant

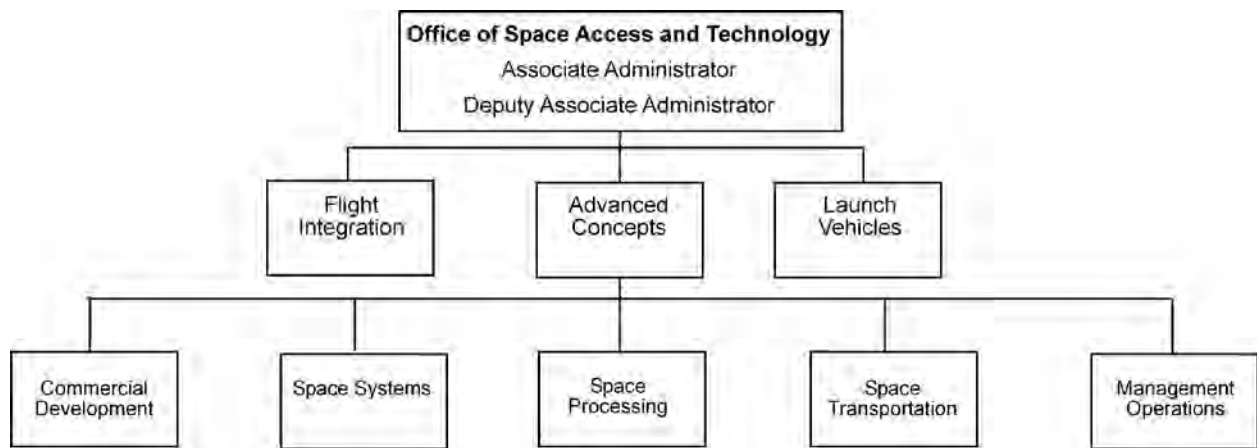

Figure 3-5. Office of Space Access and Technology (Derived from NASA HQ Telephone Directory).

Late in 1994, the NASP program was canceled and its program office in the Office of Aeronautics was eliminated.

On April 28, 1995, Aeronautics Associate Administrator Harris was named Deputy Chief Engineer (Aeronautics). Whitehead, the Deputy Associate Administrator, moved to the position of acting Associate Administrator and was appointed Associate Administrator on June 26, 1995. Christiansen moved to the position of acting Director of Critical Technologies, and also continued in his position as Director of High Performance Aircraft and Flight Projects.

Changes to the Office of Aeronautics in the fall of 1995 included the selection of Douglas G. Kirkpatrick as acting Director for Institutions, and Ray V. Hood as acting Director of the Subsonic Transportation Division. In early 1996, several divisions within the Office of Aeronautics were eliminated:

- High Performance Aircraft and Flight Projects, headed by Richard Christiansen
- High-Speed Research, headed by Vincent L. Rausch
- Institutions, headed by Douglas G. Kirkpatrick
- Strategy and Policy Office, headed by Jay M. Henn
- Critical Technologies, headed by Richard Christiansen
- Subsonic Transportation, headed by Ray V. Hood

Three organizations were created:

- Aerospace Research Division, headed by Richard Christiansen
- Alliance Development Office, headed by Louis J. Williams
- Management Support Office, headed by Cathy H. Mangum

The High Performance Computing and Communications Office, headed by Holcomb, became the Aviation Systems Technology Division, also headed by Holcomb.

In OSAT, Col. Gary E. Payton became head of the Space Transportation Division in June 1995.

In the fall, Charles J. Arcilesi became acting Director of the Launch Vehicles Office, replacing Charles Gunn.

Phase III (1996–1998)

Late in 1996, OSAT was eliminated. The Office of Aeronautics assumed some of the responsibilities of the Space Access Office, becoming the Office of Aeronautics and Space Transportation Technology. NASA also replaced the program office structure with an enterprise

structure headed by an enterprise associate administrator (see figure 3-6).⁸² Responsibility for particular areas of advanced technology development was split among the four enterprises and was coordinated by a chief technologist in the Office of the Administrator. The Mission to Planet Earth (MTPE) assumed responsibility for the small spacecraft technology initiative (the Advanced Smallsat program) and the commercial remote sensing program.⁸³ Whitehead became the Enterprise Associate Administrator of the larger aerospace organization, and Richard Reeves became Deputy Associate Administrator. Payton was Deputy Associate Administrator for Space Transportation Technology. The divisions and directors within the Aeronautics and Space Transportation Technology Transportation Enterprise were as follows:

- Resources Management Office: Glenn C. Fuller
- Aviation Systems Technology: Lee B. Holcomb
- Alliance Development Office: Louis J. Williams
- Aerospace Research: Richard S. Christiansen
- Management Support Office: Kathryn C. Ferrare
- Space Transportation: Gary E. Payton
- Commercial Technology: Robert L. Norwood

⁸² NASA Headquarters telephone directories continued to use the former "Office" designation.

⁸³ "Budget Summary, Office of Mission to Planet Earth," Science, Aeronautics, and Technology, FY 1998 Estimates, p. SAT 3-5.

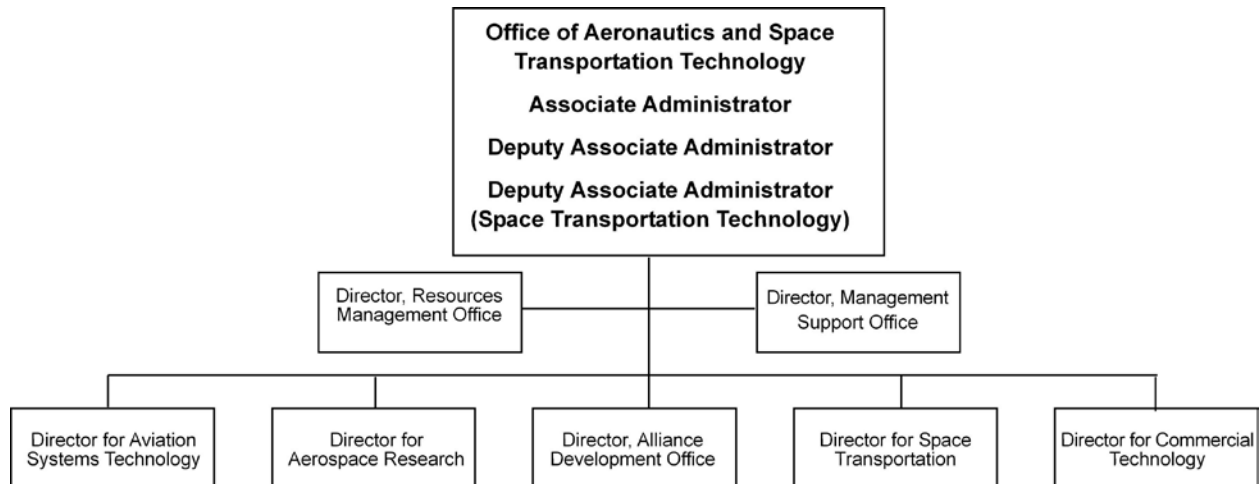

Figure 3-6. Office of Aeronautics and Space Transportation Technology (Derived from NASA HQ Telephone Directory).

In mid-1997, Anngienetta Johnson replaced Ferrare in the Management Support Office. Associate Administrator Whitehead retired at the end of 1997 and Christiansen became acting Associate Administrator.⁸⁴ On March 2, 1998, Wallace Sawyer moved from NASA's Langley Research Center, where he had been Program Manager for the High Speed Research Program, to become acting Deputy Associate Administrator for Aeronautics and Space Transportation Technology. On May 11, Michael B. Mann became Deputy Associate Administrator of the Aeronautics and Space Transportation Technology Enterprise. Spence M. Armstrong became Associate Administrator. Payton was Deputy Association Administrator for Space Transportation Technology. Other directors in the Enterprise were:

- Resources Management Office: Glenn C. Fuller
- Research and Technology: Terrence J. Hertz (acting)
- Alliance Development Office: Louis J. Williams

⁸⁴ In 1997, NASA moved from the program office organizational structure to the strategic enterprise structure.

- Aerospace Research: Richard S. Christiansen
- Commercial Technology: Robert L. Norwood

On October 14, 1998, the Office of Aeronautics and Space Transportation Technology (OASSTT) was renamed the Office of Aerospace Technology (OAST). The Aeronautics and Space Transportation Enterprise became the Aerospace Technology Enterprise.

Money for Aeronautics, Space Technology, and Exploration

At the end of the decade in 1998, funding for NASA's aeronautics and space R&T programs was at a higher level than it was at the beginning of the decade. In particular, aeronautics funding grew from \$309.2 million in FY 1989 to \$920.1 million in FY 1998—an increase of more than 66 percent (without considering inflation), excluding funding for commercial programs, which was budgeted with advanced transportation beginning in FY 1993. Although funding decreased three times during the decade, the decreases were small (2.4 percent in FY 1993, 2.5 percent in FY 1995, and 1.1 percent in FY 1997).

Space R&T, however, did not fare nearly as well. Even though total funding increased by 31 percent from the beginning of the decade to the end, decreases in funding were much more dramatic than in the aeronautics area. The first decline of the decade was minor: in FY 1990 funding fell by a mere 0.6 percent. However, it fell significantly in FY 1995 from its decade high of \$502.4 million to \$435.7 million, and even more drastically in FY 1996 to \$234 million from the previous year. Funding in FY 1998 was still below the level attained in FY 1993.

The FY 1995 decrease reflected a dramatic reduction in flight-program funding from \$140.9 million in FY 1994 to \$3.5 million in FY 1995 following the transfers of the In-STEP program to Spacecraft and Remote Sensing, and the Space Station Utilization program to Space Processing. At the time, only the Launch Voucher program, an inflatable-flight experiment, and the Commercial Middeck Augmentation Module (CMAM) contract with SPACEHAB, Inc., remained. The Launch Vehicles Support program also was no longer funded in this area. An even greater decrease in available funds for space R&T that occurred in FY 1996 reflected the program's almost complete focus on developing "affordable and reliable access to space early in the 21st century," as Spacecraft and Remote Sensing, Flight Programs, Space Processing, and Advanced Small-Satellite Technology were no longer funded programs.⁸⁵

The transatmospheric program funded the National Aerospace Plane (NASP), or X-30, program, which was a joint NASA- DOD activity. It was canceled in 1994 after funding problems increased and efforts to develop the necessary technology became more challenging than anticipated.

Table 3-1 shows programmed amounts for the years 1989–1998. Tables 3-2 through 3-29 show budget requests and programmed amounts for the programs within aeronautics, space R&T, and exploration. Since NASA typically submits both an original and a revised budget request before Congress acts on a budget, both amounts are indicated, separated by a "/." Where no amount appears, there was no submission. Programmed amounts reflect the amounts actually available to be spent. Occasionally, a budget category is established during a fiscal year. When this happens, there will be a programmed amount but no budget request for that budget category. Funds for

⁸⁵ "Office of Aeronautics and Space Transportation Technology," FY 1998 Estimates, p. SAT 4-2.

these activities often were transferred from another project's budget through a "reprogramming" of funds during the year. All amounts come from the annual budget requests prepared by the NASA Office of the Chief Financial Officer. An explanation of NASA's budget process can be found in chapter 1 of volume VII of this data book.

Aeronautics R&T

NASA's aeronautics program focused on theoretical and computational R&T (its R&T base), various classes of aircraft (subsonic aircraft, rotorcraft, high-speed air transportation, high-performance aircraft, and hypersonic vehicles), and maintaining and operating national facilities in support of other NASA programs, as well as industry and DOD projects. Safety and environmental issues were particular concerns. Many programs were conducted jointly with the Federal Aviation Administration or the DOD to benefit commercial aviation and develop new military capabilities. Industry was a vital partner at all levels of involvement, and an important emphasis was placed on transferring NASA-developed aeronautical technology to the private sector.

R&T Base: Critical Disciplines

The R&T base provided a strong fundamental foundation for future aviation advances. Major areas of emphasis included developing a fundamental understanding of a broad range of physical phenomena and computational methods to analyze and predict the physical phenomena and perform appropriate experimental validations.

Aerodynamics

Aerodynamics was a critical discipline that explored a wide range of fluid-flow phenomena from basic fluid mechanisms to applied aerodynamics. Validated aerodynamics technologies were developed through theoretical, computational, and experimental efforts that applied to civil and military aircraft across all speed ranges. The advanced computational methods developed as a result of this research enabled more accurate and efficient prediction of an aircraft's aerodynamic performance and the exploration of fluid-physics phenomena. CFD provided powerful analytical, simulative, and predictive tools to describe the complex physics of aerodynamic flow. Research included flow diagnostics using modern CFD tools to improve understanding of the detailed mechanisms associated with induced drag. In some cases, CFD supplanted wind tunnels for evaluations of aircraft.⁸⁶ Figure 3-7 shows a CFD image of the Hyper-X vehicle at Mach 7.

⁸⁶ "Research and Technology Base," Office of Aeronautics and Space Technology Fiscal Year 1993 Estimates, p. RD 12-4. Also *NASA Aeronautics: Research and Technology, Program Highlights*, NP-129, p. 29.

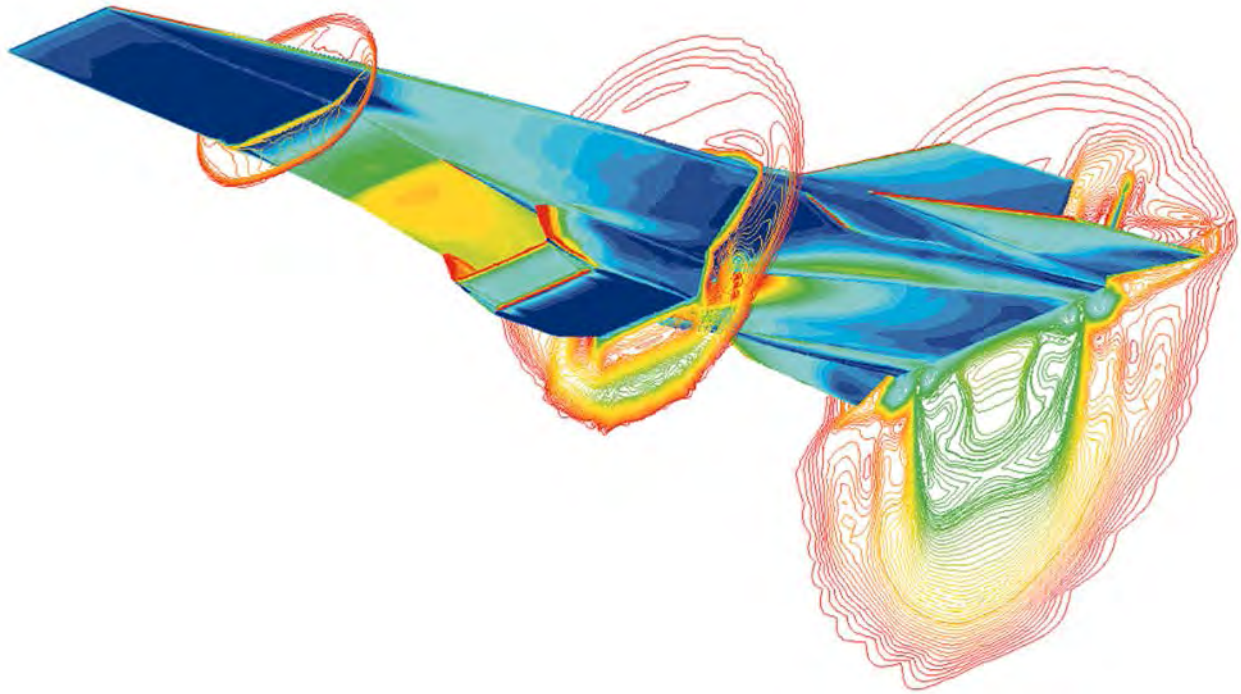

Figure 3-7. This computational fluid dynamics (CFD) image is of the Hyper-X vehicle with the engine operating under the Mach 7 test condition. The image illustrates surface heat transfer on the vehicle surface (red is highest heating) and flowfield contours at the local Mach number (NASA-Dryden photo ED97-43968-01).

Propulsion and Power R&T

The Propulsion and Power program explored physical phenomena at the disciplinary, component, and subsystem levels to provide a basis for improved propulsion systems. Ongoing disciplinary research in instrumentation, controls, and internal fluid mechanics provided the foundation necessary for continued advancement at the component and subsystem levels, with tools developed at Ames Research Center. Propulsion research was centered at Lewis Research Center.⁸⁷

⁸⁷ “Research and Technology Base,” Office of Aeronautics and Space Technology Fiscal Year 1993 Estimates, p. RD 12-5.

Materials and Structures

The Materials and Structures program developed advanced materials, analysis and test methods, and structural concepts to enable the design of safe, lightweight airframes and lightweight, durable, fuel-efficient engines. Analytical research focused on advanced computational methods from the micromechanics level through global response of full-scale aircraft, aeroelastic response and control, and multidisciplinary design and optimization. Airframe materials and structures research focused on investigating the fundamental behavior of materials, and fabrication technologies for light metals and composites. Promising technologies and structures included the geodesic stiffened spar web airframe design and enhanced diffusion bonding (EDB) for fabricating lightweight, high-temperature structures. Researchers at Langley Research Center also developed an advanced capability to computationally predict the unsteady transonic aerodynamic loads on realistic aircraft configurations using a faster and more stable procedure compared to previous computational approaches.⁸⁸

Information Sciences and Human Factors

Encompassing controls and guidance, the Information Sciences and Human Factors program provided a technology base that supported future aircraft designs for safer and more efficient operations, and greatly expanded flight envelopes. Human Factors focused on flight management, human engineering methods, and cockpit automation aids. Controls and guidance research focused on improving the efficiency and effectiveness of future fixed-wing and rotary aircraft, advanced aircraft control methodologies, reliability and validation techniques, and guidance and display concepts. The return of the Advanced Transport Operating System (ATOPS) B-737 research aircraft to flight status after it underwent a modernization upgrade

⁸⁸ “Research and Technology Base,” Office of Aeronautics and Space Technology Fiscal Year 1993 Estimates, p. RD 12-6. Also *NASA Aeronautics: Research and Technology, Program Highlights*, NP-129, pp. 37–38.

resulted in a number of successful research projects, including the inflight application of artificial intelligence to flight-control-system software. New approaches to minimize windshear hazards were addressed, with the F-Factor hazard index becoming an industry standard.⁸⁹

Flight Systems

The Flight Systems program supported aviation safety, flight-test methodologies, and air vehicle advanced technology-demonstration validation. In FY 1991, a three-year effort was initiated in the icing program to assemble and assess an overall airplane computational code to predict the effects of ice on the performance and stability of swept-wing and commuter aircraft. A joint U.S. Air Force/NASA test of advanced, low-power deicer systems on the B1-B engine inlet components was also conducted. This followed the test program on several advanced, low-power deicer systems conducted during FY 1991 to determine the more effective candidate deicer systems. In other activities, concepts for improving air traffic control were studied, and a research program investigating the character and effect of lightning strikes on aircraft was completed. More flexible electronic displays and a variety of automated flight-management devices that provided fully automated routine flight management from takeoff to landing, regardless of weather and with a reduced inflight workload, were introduced. However, because the air traffic control system had not been sufficiently upgraded to permit the full use of automated flight-control systems, certain problems resulted that required further study. Field tests of the Traffic Advisory and Collision Avoidance System verified the adequacy of the system.⁹⁰

⁸⁹ "Research and Technology Base," Office of Aeronautics and Space Technology Fiscal Year 1993 Estimates, p. RD 12-6. Also *NASA Aeronautics: Research and Technology, Program Highlights*, NP-129, p. 40.

⁹⁰ "Research and Technology Base," Office of Aeronautics and Space Technology Fiscal Year 1993 Estimates, pp. RD 12-6–RD 12-7. Also *NASA Aeronautics: Research and Technology, Program Highlights*, NP-129, p. 41.

Systems Analysis

Researchers in the aeronautics Systems Analysis program conducted long-term technology assessments, identified technology applications, and performed sensitivity analyses and trade-off studies from which effective R&T programs could be developed to meet future civil and military aeronautics requirements. Studies focused on defining influential, long-range R&T needs for specific vehicle classes. Efforts included conceptual design studies and economic benefit analyses for advanced rotorcraft and subsonic transports. Other studies investigated technology trade-offs for hypersonic vehicles, supersonic transport, and high-performance aircraft to enable the most effective use of resources.⁹¹

Focused Systems Research

Subsonic Transport

NASA's subsonic transport research focused on the technology required to develop a new generation of fuel-efficient, affordable aircraft and improve the safety and productivity of the National Airspace System, including the fleet of aging aircraft. Principle areas included aviation safety, environmental impact, aviation system capacity, and the cost of air travel.

Safety

A major goal was to reduce the fatal aircraft accident rate by 80 percent in 10 years and by 90 percent in 25 years. Safety activities typically were related to weather conditions in the air and on the ground, turbulence, human factors (particularly the use of automation to improve safety), and issues involving the increasing age of the nation's fleet of aircraft.

⁹¹ "Research and Technology Base," Office of Aeronautics and Space Technology Fiscal Year 1993 Estimates, p. RD 12-7.

Runway safety. In support of a national goal to reduce the aircraft fatal-accident rate by 80 percent in 10 years and by 90 percent in 25 years, NASA partnered with Transport Canada and the FAA in an ongoing five-year program called the Joint Winter Runway Friction Measurement program. Beginning in January 1996, the study, which was led by Langley Research Center, used instrumented aircraft, friction-measuring ground vehicles, and test personnel from around the world to investigate technology concepts to increase understanding of runway friction and develop improved tire designs, better chemical treatments for snow and ice, and new types of runway surfaces to minimize the effects of bad weather.

Data collected from 1996 to 1999 included nearly 400 instrumented aircraft test runs and more than 8,000 ground vehicle runs. Surface conditions were artificially varied to expand the range of the data collected, and many different runway friction-measuring ground vehicles—vans, trailers, and modified cars—took readings with continuous and fixed slip devices under similar runway conditions for comparison with each other and with the braking performance of the two instrumented aircraft.

Since testing began, five instrumented aircraft and 13 ground test vehicles have been evaluated at sites in Canada, the United States, and Norway. The test aircraft included the Canadian National Research Council's Falcon 20, the FAA's B-727, a De Havilland Dash 8, and NASA's B-737 and B-757 research aircraft. The friction-measuring ground devices came from a number of international partners. Transport Canada's surface friction tester and electronic recording decelerometer; the Scottish GripTester; the French IMAG; Norway's RUNAR, ROAR, and airport surface friction tester; the FAA's runway friction tester and BV-11 trailer; the American

Society for Testing and Materials (ASTM) E-274 skid trailer; and NASA's instrumented tire-test vehicle and diagonal-braked vehicle all contributed data.

Researchers also took manual measurements to monitor conditions before and after a test run series (see figure 3-8). They recorded ambient temperature; temperatures of pavement surface and snow, slush, or ice; the depth of the cover material (water, snow, slush, or ice); and (in the case of snow or slush) the density of the cover material. From these data the team developed an international runway friction index to standardize friction reporting from different devices and to help pilots make critical takeoff and landing decisions.⁹²

⁹² *Aeronautics & Space Transportation Technology; Three Pillars for Success: Turning Goals Into Reality, Annual Progress Report 1997–1998*, p. 21. Also “Winter Runway Safety Subject of New Study,” *NASA News Release 96-018*, March 1996, http://www.nasa.gov/centers/langley/news/releases/1996/Mar96/96_18.html (accessed July 5, 2006). “Research Aims To Prevent Accidents on Hazardous Runways,” FS-1999-07-45-LaRC, July 1999, <http://www.nasa.gov/centers/langley/news/factsheets/WinterRunway.html> (accessed July 5, 2006).



Figure 3-8. Joint Winter Runway Friction Measurement program, North Bay, Ontario, Canada. Researchers took manual measurements of ambient runway conditions before and after a test run series (NASA-LaRC photo EL-2000-00311).

Anti-Icing Fluid. In 1997, Ames Research Center developed a patented anti-icing fluid to keep ice from building up on aircraft wings. The fluid was so environmentally safe it was referred to as “food grade.” When applied to a dry surface, the fluid prevents ice from forming a surface bond, thus saving deicing time and money, and preventing excessive use of chemical solvents. If applied after ice has formed, it serves as a traditional deicing formula. The new fluid contains propylene glycol, which is approved by the Food and Drug Administration for use in food, instead of ingredients such as ethylene glycol and other additives that could sicken or kill water life, animals, or people. The fluid, which is effective in temperatures as low as -70°F (-56°C),

was also adopted for use on runways, bridges, ships, train tracks, and automobiles. It works by “grabbing” onto an airplane’s surface better than current fluids when a plane is at rest. When the plane takes off, the fluid becomes thinner and blows away so the wings remain clean, increasing the amount of lift as the plane rises.⁹³

Tailplane Icing Program (TIP). The NASA/FAA TIP was a four-year icing research program that began in 1994 and used facilities at NASA’s Icing Research Tunnel, a De Havilland DHC-6 Twin Otter Icing Research Aircraft at Lewis Research Center, and Ohio State University’s Low Speed Wind Tunnel. The comprehensive program improved understanding of aircraft aerodynamics and performance under iced-tailplane conditions. It developed training aides and analytical tools to help discriminate tailplane sensitivity to icing and expand awareness of the aviation threat known as “ice-contaminated tailplane stall.” The program included icing wind tunnel tests, dry-air aerodynamic wind tunnel tests, flight tests, and analytical-code development. It developed a comprehensive database on tailplane aeroperformance, identified dominant drivers leading to tailplane stall, demonstrated effective tailplane stall recovery procedures, and provided inflight demonstrations for guest pilots. Fifteen guest pilots and engineers flew the Twin Otter and witnessed the flying qualities of an aircraft with an ice-contaminated tailplane.⁹⁴

Ice “Zapping” System. A new ice removal system was developed to include with the first new general aviation aircraft introduced in the United States in 15 years. The Electro-Expulsive

⁹³ “NASA Ames ‘Food Grade’ Anti-Icing Fluid Also Reduces Auto Rust, *NASA News Release 97-133*, June 12, 1997, <ftp://ftp.hq.nasa.gov/pub/pao/pressrel/1997/97-133.txt> (accessed July 5, 2006). Also “New Fluid Prevents Railway Ice,” *Spinoff*, 2001, <http://www.sti.nasa.gov/tto/spinoff2001/ps3.html> (accessed July 7, 2006); “Ice Free Originating Technology/NASA Contribution,” *Spinoff*, 2006.

⁹⁴ *Aeronautics & Space Transportation Technology; Three Pillars for Success: Turning Goals Into Reality, Annual Progress Report 1997–1998*, pp. 22–23. Also Thomas P. Ratvasky et al., “NASA/FAA Tailplane Icing Program Overview,” NASA Technical Memorandum-1999-208901, AIAA-99-0370, NASA Lewis Research Center, January 1999, <http://gltrs.grc.nasa.gov/reports/1999/TM-1999-208901.pdf> (accessed July 5, 2006).

Separation System, or “ice zapper,” pulverizes ice into small particles and removes layers of ice as thin as frost or as thick as an inch of glaze. It uses 0.001 the power and is 0.1 the weight of electro-thermal ice removal systems. In less than a millisecond, an electric current runs through parallel layers of flat copper ribbon bonded to the aircraft’s wings, engine inlets, and other airplane parts where ice could form. A repelling magnetic field is created, causing a high acceleration to break the ice into tiny particles that fall from the plane’s surface. The system can run continuously during flight, pulsing once or twice a minute to keep airplane surfaces ice-free. In 1995, NASA licensed the ice zapper to Ice Management Systems, Inc., for development and marketing. The company agreed to develop the system for Lancair Inc., which tested the system with the Lancair IV aircraft.⁹⁵

Windshear. Beginning in 1986, Langley Research Center carried out windshear studies consisting of analyses, simulation, and flight tests in a joint effort with the FAA to reduce the number of fatal accidents caused by this hazardous weather condition. Using the NASA B-737 research aircraft, NASA flight-tested three detection systems. The first, microwave radar, sent a microwave radar signal ahead of the aircraft to seek raindrops and other moisture particles. The return signal represented the motion of those particles and was translated into wind speed. Langley developed the research signal-processing algorithms and hardware for this windshear application.

⁹⁵ “NASA Lightweight ‘Ice Zapper’ To Be Used on New Aircraft,” *NASA News Release 98-104*, June 16, 1998, <ftp://ftp.hq.nasa.gov/pub/pao/pressrel/1998/98-104.txt> (accessed July 5, 2006). Also *Aeronautics & Space Transportation Technology; Three Pillars for Success: Turning Goals Into Reality, Annual Progress Report 1997–1998*, p. 23.

The second detection system was the Doppler lidar, which reflected energy from minute particles called aerosols. Its advantage was that it avoided picking up the signals from “ground clutter,” such as moving cars, and had fewer interfering signals. This system did not work as well in heavy rain as microwave radar.

The third detection system used an infrared detector to measure temperature changes ahead of the airplane. It monitored the thermal signatures of carbon dioxide to look for cool columns of air that could be characteristic of microbursts. This system was less costly and complex, but did not measure wind speeds directly. The system was flight-tested beginning in 1991 and the results showed that the forward-looking Doppler radar was able to provide pilots with a 20- to 40-second warning of upcoming microbursts.

Information from Langley’s tests contributed to a database on microbursts and detection systems. The data gathered from analyses, simulations, laboratory tests, and flight tests helped the FAA certify predictive windshear detection systems for installation on commercial aircraft.⁹⁶ In 1992, the NASA-FAA windshear program was nominated for a Collier Trophy, the highest honor an aviation program could receive. Hastened by FAA regulations mandating that airliners install windshear-detection devices, the technology quickly moved to the commercial sector.⁹⁷ In 1994, Continental Airlines became the first commercial airline to adopt the new system.

⁹⁶ “Making the Skies Safe from Windshear; Langley-Developed Sensors Will Help Improve Air Safety,” Langley Research Center Fact Sheet, June 1992, <http://www.nasa.gov/centers/langley/news/factsheets/Windshear.html> (accessed May 25, 2006).

⁹⁷ Lane Wallace, *Airborne Trailblazer: Two Decades with NASA Langley’s 737 Flying Laboratory* (Washington, DC: NASA SP-4216, 1994), p. 73.

In the mid and late 1990s, avionics companies rapidly provided advanced windshear-detection systems. By June 1996, a number of vendors, including Allied Signa/Bendix, Rockwell Collins, and Westinghouse Electric, produced FAA-certified forward-looking windshear radar systems. By the end of the decade, foreign and domestic carriers, as well as the U.S. Air Force, had placed more than 2,000 orders for the systems. These windshear-detection systems worked by issuing microburst warnings within a specific distance and within a specific angular sector of the aircraft's heading. A warning icon appears on the radar display and a voice synthesizer issues an aural warning. The program was an outstanding example of cooperation between government agencies, manufacturers of aircraft and sensors, airlines, research organizations, and academia.⁹⁸

Air Turbulence Research. In the spring of 1998, Dryden Flight Research Center completed its first series of flight tests of a sensor to detect clear air turbulence. The sensor device, called Airborne Coherent Lidar for Advanced Inflight Measurement (ACLAIM), was designed and built for NASA by Coherent Technologies of Lafayette, Colorado. ACLAIM relied on Light Detection and Ranging (LIDAR) technology to detect changing velocities of tiny particles in turbulent air. In the first tests, the experiment team located turbulent conditions before the aircraft flew through the disturbed air, and used the infrared laser radar to measure the changes in wind speed (a measure of turbulence). The crew members then compared the pre-encounter measurements with the effects of the turbulence they experienced, exploring the relationship between the laser radar-measured turbulence characteristics and the actual turbulence experienced by the aircraft. The tests provided an efficient checkout of the flight hardware and helped characterize turbulence measurements, enabling researchers to construct a database to

⁹⁸ Joseph R. Chambers, *Concept to Realty; Contributions of the NASA Langley Research Center to U.S. Civil Aircraft of the 1990s* (Washington, DC: NASA SP-4529, 2003), p. 198.

learn more about accurately detecting and forecasting turbulence. The ACLAIM sensor could alert pilots to turbulence 20 seconds to 1 minute away, giving them time to take safety precautions and warn the crew and passengers.⁹⁹ Experiments were flown on three separate flights for a total of more than 7 hours at altitudes as high as 25,000 feet (7,620 meters).¹⁰⁰

Modeling of Trailing Vortices. Wake vortex issues were evaluated as an element of investigating reduced separation requirements between aircraft. Wake vortices can be dangerous when aircraft are within a particular distance of each other. Improved aircraft design may produce vortices that dissipate more quickly and are less hazardous to nearby aircraft. In 1997, Langley Research Center conducted a study to improve the modeling of vortex flows off aircraft wing tips and vortex breakdowns.¹⁰¹ The results showed that the class of models known as Reynolds-stress turbulence models gave much more accurate calculations than other models, yielding significantly better predictions of the breakdown location.¹⁰²

Engine-Monitoring and Control System (E-MACS). In the research area of automation and human factors, automated piloting and air traffic control aids were developed and evaluated during this decade. At Langley Research Center in 1990, pilots evaluated E-MACS, an information concept that summed up engine performance in columnar displays and showed variances between real and ideal values. Pilots preferred this format over the round dials and

⁹⁹ *Aeronautics & Space Transportation Technology; Three Pillars for Success: Turning Goals Into Reality, Annual Progress Report 1997–1998*, p. 24.

¹⁰⁰ “Forty Years: NASA’s Aviation Safety Efforts Soar,” *Aerospace Technology Innovation* 6, no. 3 (May/June 1998): 8, <http://ipp.nasa.gov/innovation/Innovation63/innov63.pdf#search=%22Forty%20Years%3A%20NASA%E2%80%99s%20Aviation%20Safety%20Efforts%20Soar%22> (accessed August 2, 2006).

¹⁰¹ Trailing vortices are invisible, thin, tornado-like cones that can potentially be hazardous in heavy air traffic around airports.

¹⁰² *Aeronautics & Space Transportation Technology; Three Pillars for Success: Turning Goals Into Reality, Annual Progress Report 1997–1998*, p. 24.

gauges found in many aircraft cockpits. In one test comparing the two types of displays, pilots missed 43 percent of engine faults with the conventional round displays but detected every single fault with the E-MACS display. In February 1991, the system was tested on the Transport Systems Research Vehicle (TSRV) under realistic flight conditions. Although the technology seemed promising, aircraft manufacturers were concerned about the system's ability to judge an engine's performance over time, since what was considered "normal" typically changed as an engine aged and its maximum performance lessened. The system was first adopted by a manufacturer of aviation avionics rather than by the air transport industry.¹⁰³ Researchers at Langley began to design an "error-proof flight deck" concept based on "human-centered" design. The research focused on developing methods to identify and control factors that lead to human error. Implementing such a design would allow for human error without jeopardizing the safety and efficiency of a mission.¹⁰⁴

Fly-By-Light/Power-By-Wire. The goal of this focused research area was to develop technologies for lightweight, highly reliable, electromagnetically immune control and power management systems for advanced subsonic civil transport aircraft. In FY 1994, an experimental laboratory designed to assess the effects of high-intensity radiated fields on electronic systems and avionics was completed and used to validate the behavior of electromagnetic (EM) flight-test instrumentation. Critical optical and power components, such as electrical actuators and fiber-optic sensors and cables, were exposed to a simulated flight environment. In FY 1995, the EM

¹⁰³ Lane Wallace, *Airborne Trailblazer* (Washington, DC: NASA SP-4216, 1994), pp. 84–85.

¹⁰⁴ *Aeronautics & Space Transportation Technology; Three Pillars for Success: Turning Goals Into Reality, Annual Progress Report 1997–1998*, p. 25.

instrumentation was ground-tested on the TSRV and flight-tested later in 1995.¹⁰⁵ Four fly-by-light aircraft control architecture concepts were evaluated by means of simulation and analysis to assess safety issues, databus configurations, and life-cycle costs. An architecture that was determined to be safe and equivalent in performance to the most modern airplane fly-by-wire control systems was selected for detailed design.¹⁰⁶

Neural Network Software. A major milestone in the development of neural network software was reached in February 1998 when the NeuroEngineering Group at Ames Research Center delivered the final version of the real-time Dynamic Cell Structure neural network learning software to Boeing, its partner in the project. The software allows a pilot to regain some control after the simulated loss of part of a control surface, such as a wing or elevator, or some other type of damage to the airplane by comparing what actually is happening in flight (using the airplane's sensor data) with how the airplane should fly. If a failure or accident causes a mismatch, the neural net rapidly learns to trim or adjust the stick, engines, or control surfaces to correct the aircraft's flying pattern for the pilot in less than one-sixth of a second. A preliminary performance evaluation using an F-15 test aircraft was successful, and Boeing began incorporating the software into the newly redesigned F-15 flight processor board.¹⁰⁷

Tests of the software were conducted at Dryden Flight Research Center in early 1999 using a highly modified F-15 aircraft that operated with a neural adaptive flight controller. Fourteen test flights over a four-week period with the new software demonstrated how a preliminary version

¹⁰⁵ "Office of Aeronautics, Aeronautical Research and Technology," Fiscal Year 1996 Estimates, http://www.hq.nasa.gov/office/budget/fy96-sat_4.html (accessed June 19, 2006).

¹⁰⁶ "Office of Aeronautics, Aeronautical Research and Technology, Fiscal Year 1997 Estimates," p. SAT 4-40.

¹⁰⁷ *Aeronautics & Space Transportation Technology; Three Pillars for Success: Turning Goals Into Reality, Annual Progress Report 1997-1998*, pp. 26-27.

of the neural network software that was “pretrained” to the F-15’s aerodynamic database could correctly identify and respond to changes in aircraft stability and control characteristics, immediately adjusting the control system to maintain optimal flight performance under normal and simulated failure conditions. The neural network software may eventually be installed in commercial jets with digital fly-by-wire flight-control systems to help pilots recover aircraft control during emergencies. The project was among 27 finalists for the 10th Annual Discover Awards from an international field of thousands of entrants.¹⁰⁸

Aging Aircraft Program. Beginning in 1992, the Aging Aircraft program focused on accelerating development of nondestructive evaluation (NDE) technology to ensure the long-term structural integrity and safe operation of aging civil transport aircraft. The program built on NASA’s expertise in acoustic and thermal inspection methods, fatigue of metallic materials, and stochastic modeling for structural life prediction. It developed computational methods to predict multisite fatigue crack growth and the residual strength of aluminum airplane fuselages.¹⁰⁹

During 1992, cost-effective, large-area NDE technologies with advanced sensor and signal processing concepts were initiated. Of high priority was the development of a technology that would enable rapid, automated, wide-area inspections of disbonds, fatigue cracking, and corrosion damage in older transport aircraft. A methodology for analyzing fatigue and fracture in aircraft structures that contained riveted joints with multisite fatigue damage was developed. In

¹⁰⁸ :NASA Testing New Aircraft Safely Flight Control Software,” NASA Ames Research Center News Release 99-21AR, April 14, 1999, http://www.nasa.gov/centers/ames/news/releases/1999/99_21AR.html (accessed July 6, 2006). Also “Three NASA Projects Chosen as ‘Discover Award’ Finalists,” NASA Ames Research Center News Release 99-41AR, June 22, 1999, http://www.nasa.gov/centers/ames/news/releases/1999/99_41AR.html (accessed July 6, 2006). “NASA Testing New Aircraft Safety Flight Control Software,” NASA Ames Research Center News Release 99-21AR, April 14, 1999, http://www.nasa.gov/centers/ames/news/releases/1999/99_21AR.html (accessed July 6, 2006).

¹⁰⁹ “Office of Aeronautics, Exploration, and Technology, “Fiscal Year 1992 Estimates, p. RD 12-25.

addition, global and local analysis procedures for relating localized failure mechanisms to overall structural integrity and verification of the structural fatigue analyses were established. These activities were carried out cooperatively with the FAA and the air transport industry.¹¹⁰

In FY 1994, the program completed the development of computational methods for predicting multisite fatigue crack growth and the residual strength of aluminum airplane fuselages. In cooperation with several U.S. airlines and the U.S. Air Force, NDE techniques used on large fuselage surface areas were verified.¹¹¹ Efforts also focused on developing and verifying an analytical methodology for predicting when small fatigue cracks would become so widespread that the residual strength of the fuselage would be reduced below a safe level, and establishing requirements for in-service inspection technology. NASA worked cooperatively with several U.S. airlines to develop and demonstrate advanced, large-area NDE methods that could lower costs while maintaining inspection reliability. A new thermal method to detect disbonds identified corrosion that might be present in disbanded regions.¹¹²

In 1996, Langley Research Center developed and evaluated a technology for rapidly and reliably detecting fatigue damage (typically microscopic cracks in aircraft structures) caused primarily by the repeated stresses experienced during takeoff and landing. Such cracks could potentially cause catastrophic failures. The technology was integrated into a small handheld, battery-operated electromagnetic probe, called a Rotating Self-Nulling Eddy Current Probe. This probe could detect cracks in thin-sheet aluminum that were 70 percent smaller than those detected with other techniques. It used eddy currents to detect cracks caused by fatigue with a 90 percent certainty

¹¹⁰ “Office of Aeronautics and Space Technology,” Fiscal Year 1993 Estimates, pp. RD 12-27–RD 12-28.

¹¹¹ “Office of Aeronautics,” Fiscal Year 1994 Estimates, p. RD 9-37.

¹¹² “Office of Aeronautics,” Fiscal Year 1995 Estimates, pp. SAT 4-29–SAT 4-30.

rate, giving airlines increased confidence in the accuracy of NDE inspections. The probe was field-tested by aircraft manufacturers and the FAA NDE Validation Center, and made commercially available (see figure 3-9).¹¹³



Figure 3-9. The Crack Finder, a commercially available instrument with a 0.5-inch Self-Nulling Eddy Current Probe developed from NASA technology, uses a probe to detect fatigue cracks in conducting materials. The probe technology enables the device to be manufactured in a very small package and eliminates the complicated calibration and test setup procedures commonly required by other eddy-current techniques (NASA-LaRC photo EL-1996-00145).

¹¹³ *Aeronautics & Space Transportation Technology; Three Pillars for Success: Turning Goals into Reality, Annual Progress Report 1997–1998*, p. 26. Also “New NASA Langley Device Keeps the Skies Safe,” Fact Sheets, FS-1996-08-02-LaRC, August 1996, <http://www.nasa.gov/centers/langley/news/factsheets/Probe.html> (accessed July 6, 2006).

Environmental Impact

A primary goal of NASA's aeronautics research was to reduce the impact of aircraft on the environment. In its 1995 "Goals for a National Partnership in Aeronautics Research Technology," the Office of Science and Technology Policy proposed the goal of reducing emissions of future aircraft by a factor of 3 within 10 years, and by a factor of 5 within 25 years. In response, NASA's aeronautics program focused on ensuring that future aircraft and other aviation products would be environmentally friendly, particularly by conducting research to reduce nitrogen oxides emitted from jet engines. NASA worked to understand the atmospheric chemistry and impact of emissions, and to reduce engine combustion by-products.

Propulsion. Propulsion technology activities, conducted cooperatively with U.S. industry, were aimed at improving competitiveness and the market share of the nation's propulsion industry, and lessening the environmental impact of future commercial engines through reduced combustor emissions. Lewis Research Center sponsored studies by engine manufacturers Pratt & Whitney, General Electric, and Allison Engine Company on the potential benefits of advanced core technology. The studies predicted that advanced cores could reduce fuel consumption by 20–30 percent and might reduce operating costs by 6–14 percent (at early 1990s' fuel prices). The manufacturers also found that advanced technology would provide more accurate thermal efficiency, accounting for expected performance improvements of 60 percent.¹¹⁴

In FY 1994, researchers completed engine-system studies on the propulsion element to define the optimum engine cycles and associated technology needed for large-engine manufacturers, and began similar studies for commuter-sized aircraft. Advanced combustor concepts were identified

¹¹⁴ NASA *Aeronautics, Research and Technology Program Highlights*, NP 159, pp. 13–14.

and evaluated experimentally, and materials for high-temperature sections of the engine were investigated.¹¹⁵ Researchers at Lewis examined factors such as clean and efficient fuel burning and the testing of engine components developed through design and analysis in facilities that simulated engine-operating conditions. The goal was to achieve a 50 percent reduction in nitrogen oxide (NO_x) levels from the 1996 international emission standards in effect for the turbofan engines that powered large commercial aircraft. An equivalent goal was to reduce NO_x levels for the smaller turbofan engines used in regional aircraft.

From October 1997 to January 1998, four combustor designs were tested in Lewis' Advanced Subsonic Combustion Rig. The studies simulated gas turbine combustion conditions typical of future engines and provided information about NO_x formation and other emissions, including carbon dioxide, carbon monoxide, and unburned hydrocarbons, at actual combustor operating conditions for future engine cycles.¹¹⁶ The tests evaluated designs with (1) production fuel injectors, (2) elliptic-shaped swirlers, (3) macro-laminate fuel injectors, and (4) a premix chamber. The configuration with elliptic-shaped swirlers produced the lowest levels of NO_x in all test conditions.¹¹⁷ Researchers developed a new combustor liner, a ceramic matrix composite (CMC) material, that survived for more than 9,000 hours at 2,200°F (1,204°C) in laboratory tests. Achieving that lifetime was a major accomplishment in durability. At the start of the project, the state-of-the-art CMC had a less than 10-hour lifetime at 1,800°F (982°C).¹¹⁸

¹¹⁵ "Office of Aeronautics," Fiscal Year 1995 Estimates, pp. SAT 4-29–SAT 4-31.

¹¹⁶ "Safeguarding Our Atmosphere: Glenn Research Reduces Harmful Aircraft Emissions," NASA Fact Sheet FS-2000-04-010-GRC, March 2000, <http://www.nasa.gov/centers/glenn/about/fx10grc.html> (accessed July 6, 2006).

¹¹⁷ *Aeronautics & Space Transportation Technology: Three Pillars for Success: Turning Goals Into Reality, Annual Progress Report 1997–1998*, p. 28.

¹¹⁸ "Safeguarding Our Atmosphere: Glenn Research Reduces Harmful Aircraft Emissions," NASA Fact Sheet FS-2000-04-010-GRC, March 2000, <http://www.nasa.gov/centers/glenn/about/fx10grc.html> (accessed July 6, 2006).

Researchers also used computer modeling to determine the relationship between high temperatures and increased emissions. Computer predictions of the flowfield inside a jet engine combustor could help show the locations of high-temperature-NO_x-producing regions so that they could be reduced through improved combustor design. Lasers were also being used to visualize fuel-airflow patterns and make nonintrusive measurements in the combustion zone.¹¹⁹

Lewis also studied new materials that were able to withstand the higher temperatures needed to reduce carbon dioxide emissions for large aircraft by 8–15 percent. The new materials allowed engines to run hotter and cleaner without adding weight. Newly developed disk and airfoil blade materials enabled subsonic engines to run at higher operating pressures and temperatures, which reduced carbon dioxide emissions and operating costs by reducing fuel consumption.¹²⁰

SONEX Mission. The Subsonic Assessment Ozone and Nitrogen Oxide Experiment (SONEX) was an airborne field campaign that was conducted in October and November 1997 and completed in 1998. This NASA research project focused on understanding the effects of aircraft emissions on the environment. The mission used direct atmospheric measurements and theoretical models to assess the effects of NO_x emissions from subsonic aircraft on atmospheric ozone.

The mission, led by Ames Research Center, consisted of a payload of 16 instruments flying on NASA's DC-8 during February 1997 in the North Atlantic flight corridor. Investigators from NASA, other federal laboratories, and universities participated. SONEX activities were closely

¹¹⁹ Ibid.

¹²⁰ Ibid.

coordinated with the European POLINAT-2 (Pollution from Aircraft Emissions in the North Atlantic Flight Corridor) program, which used a Falcon-20 aircraft.

Science priorities included characterization of air masses, chemical climatology for standard tropospheric constituents, reactive nitrogen source apportionment and photochemistry, and testing of nitric acid instrumentation. Measurements of carbon monoxide, methane, nitrogen dioxide, carbon dioxide, and water vapor provided data on the physical and chemical structure of the upper troposphere and lower stratosphere for each set of in situ aircraft measurements. A state-of-the-art modeling and meteorological support system, which allowed targeted sampling of air parcels with desired characteristics, helped achieve specific sampling goals. The mission successfully collected a comprehensive body of data over the North Atlantic for testing and validating global models of transport and photochemistry. The researchers concluded that “increased aircraft nitrogen oxide emissions in the future will likely lead to additional ozone formation but the rate will vary greatly depending on the state of the atmosphere.”¹²¹

Noise Reduction. Langley Research Center led the noise impact reduction effort in close partnership with Ames and Lewis, as well as with industry, academia, and the FAA. With international treaty organizations actively considering more stringent noise standards, NASA’s noise-reduction element worked to develop technologies to ensure that new noise standards would not affect the growth of the air transportation system or the U.S. aircraft industry’s

¹²¹ *Aeronautics & Space Transportation Technology; Three Pillars for Success: Turning Goals Into Reality, Annual Progress Report 1997–1998*, p. 30. Also H. B. Singh, A. Thompson, and H. Schlager, “SONEX Airborne Mission and Coordinated POLINAT-2 Activity: Overview and Accomplishments,” *Geophysical Research Letter*, 26, no. 20 (October 15, 1999): pp. 3053–3056.

competitiveness in the world market.¹²² The primary effort began in 1994 when analytical computational methods and demonstrated noise-reduction concepts to reduce the impact of aircraft noise were developed. Studies focused on understanding controlling source noise mechanisms and propulsion/airframe installation aerodynamics, and developing improved aerodynamic, structural, and acoustic analysis techniques for ultra-high bypass subsonic propulsion systems. Testing and validation of selected fan and nacelle configurations to address the impact of engine/airframe integration was completed. Activities included validating an aerodynamic and performance design code, defining baseline engine noise sources, demonstrating active noise-reduction concepts for a selected nacelle configuration, evaluating novel installation concepts, and assessing current airframe noise prediction capabilities.¹²³

Engine and Nozzle Noise. Engine fan blades and the jet exit, or nozzle, are the dominant sources of engine noise. Such noise can be reduced by altering the fan blade and nozzle designs or by using acoustic liners on the nacelle to absorb the sound. In FY 1994, the first integrated fan noise source and propagation prediction code was developed and provided to industry.¹²⁴ In one project, Lewis Research Center teamed with the Allison Engine Company to investigate ways to reduce fan noise from turbofan engines. In 1997, the program met a major milestone with a demonstrated “Effective Perceived Noise Level” (3-EPNdB) fan noise reduction. This was a subjective noise metric used to measure noise impact during an aircraft flyover. A 22-inch (56-

¹²² “Office of Aeronautics, Aeronautical Research and Technology,” Fiscal Year 1994 Estimates, p. SAT 4-30.

¹²³ “Office of Aeronautics, Aeronautical Research and Technology,” Fiscal Year 1994 Estimates, p. RD 9-37.

¹²⁴ “Office of Aeronautics, Aeronautical Research and Technology,” Fiscal Year 1996 Estimates, http://www.hq.nasa.gov/office/budget/fy96-sat_4.html (accessed June 19, 2006).

centimeter) scale model was used to test the concept in Lewis' 9- by 15-foot (2.7- by 4.6-meter) low-speed wind tunnel. It used highly swept and leaned stator vane technology.¹²⁵

A joint research effort that included NASA, Pratt & Whitney, Northrop Grumman, Hersh Acoustical Engineering, and E. J. Rice Consulting demonstrated improved noise suppression in wind tunnel tests using a low-speed fan with advanced acoustic liners. An advanced active noise control concept demonstrated the technical feasibility of reducing fan tones by as much as 10 dB. In FY 1995, simulations demonstrated that adaptive noise control (ANC) varied the absorptive characteristics of an acoustic liner to optimize its performance for different engine operating conditions. A 20-dB noise reduction was demonstrated at a single frequency, indicating that ANC was a viable noise-reduction concept that offered a significant reduction in technical risk. Other activities included selecting an active noise control concept for engine demonstration, completing an engine noise database, releasing the community noise impact model, and demonstrating an active structural acoustic control on a business aircraft.¹²⁶

Airframe/Interior Noise. The landing gear and wing flaps and slats are the major contributors to airframe noise. During landing, airframe noise almost matches the level of engine noise. NASA, in partnership with industry, academia, and the FAA, demonstrated a reduction of 4 dB in flap noise in a program that involved several of NASA's wind tunnels with unique performance capabilities.¹²⁷ In FY 1994, methods for reducing noise levels in aircraft interiors were validated in laboratory tests. In FY 1995, activities included the use of computational

¹²⁵ *Aeronautics & Space Transportation Technology; Three Pillars for Success: Turning Goals Into Reality, Annual Progress Report 1997–1998*, pp. 31–32.

¹²⁶ "Office of Aeronautics, Aeronautical Research and Technology," Fiscal Year 1997 Estimates, p. SAT 4-41.

¹²⁷ *Aeronautics & Space Transportation Technology; Three Pillars for Success: Turning Goals Into Reality, Annual Progress Report 1997–1998*, p. 32.

aeroacoustics to design quieter landing gear and other aircraft components. Acoustic imaging was used to locate the optimal locations of active noise control actuators to reduce interior noise.¹²⁸ Figure 3-10 shows Boeing 757 landing gear used in a landing gear noise study at Langley Research Center.

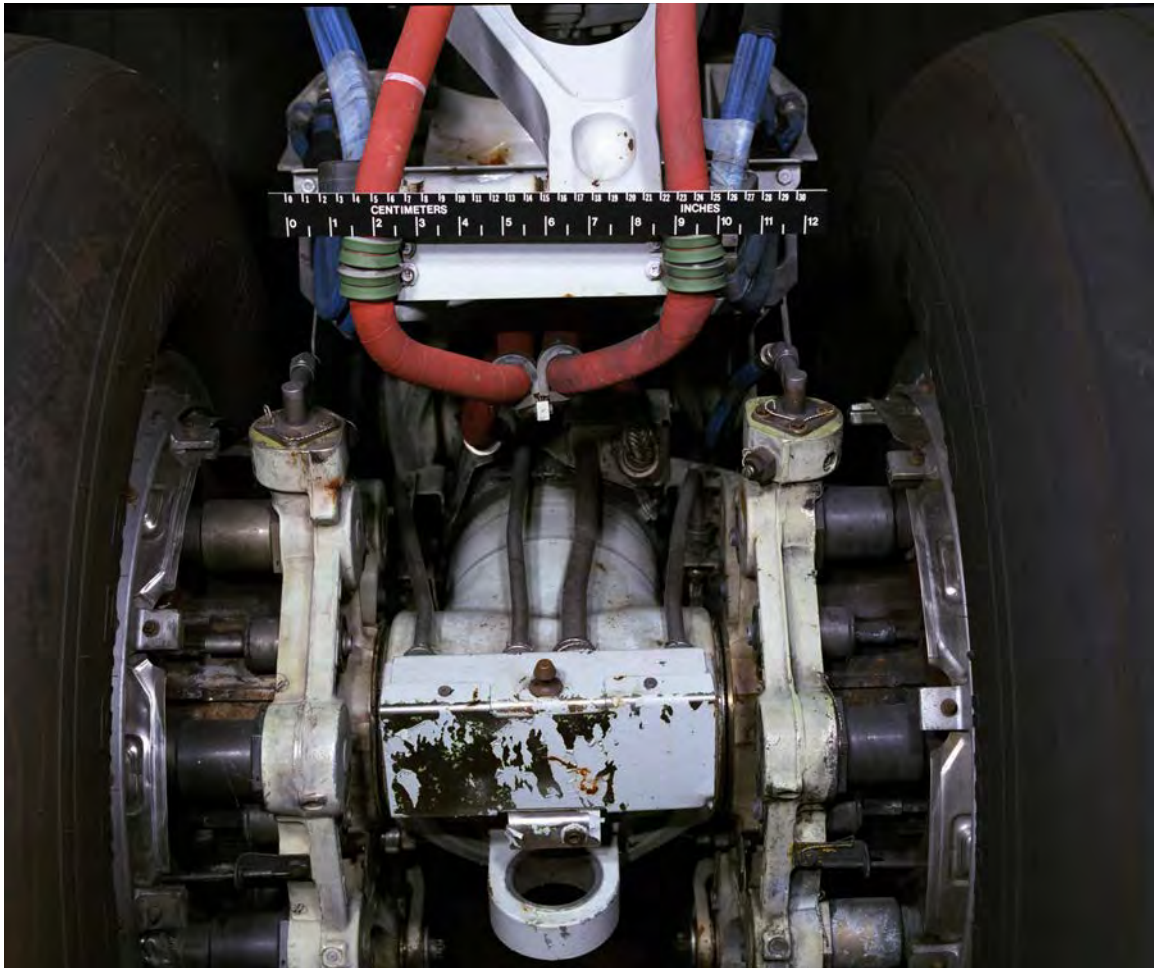

Figure 3-10. Main landing gear on the Boeing 757 was used in a landing gear noise study at NASA Langley Research Center in 1996 (NASA-LaRC photo EL-1996-00264).

¹²⁸ “Office of Aeronautics, Aeronautical Research and Technology,” Fiscal Year 1996 Estimates, http://www.hq.nasa.gov/office/budget/fy96-sat_4.html (accessed June 19, 2006).

Aviation System Capacity

Terminal-Area Productivity. In 1994, NASA began investigating terminal-area productivity.

The goal was to safely increase air traffic capacity in the terminal area during poor weather to the same level achieved during good weather. In cooperation with the FAA, NASA worked to develop and demonstrate technology and procedures in the aircraft and on the ground to safely reduce aircraft spacing in the terminal area, enhance air traffic management and reduce controller workload, improve low-visibility landing and surface operations, and perform systems analyses to ensure compatible integration of new aircraft and air traffic systems.¹²⁹ In FY 1994, the program evaluated the potential for ground-to-aircraft data communications and dynamic spacing capabilities based on NASA's air traffic control automation efforts. It investigated reduced separation requirements by evaluating wake vortex issues and community noise constraints, as well as enhanced aircraft flight management systems.¹³⁰ It also evaluated the potential of having air traffic controllers communicate with aircraft via digital data communications technology to allow for more adaptable aircraft-spacing capabilities.¹³¹

In FY 1995, installation of an existing simulator and associated computer systems began on the TSRV in preparation for future flight tests (see figure 3-11). Two-dimensional laminar wake vortex models were developed and partially validated, resulting in a recommendation to the FAA for an interim matrix approach of wake vortex separation according to aircraft classification.¹³²

¹²⁹ "Office of Aeronautics, Aeronautical Research and Technology, Fiscal Year 1995 Estimates," p. SAT 4-30.

¹³⁰ "Office of Aeronautics, Aeronautical Research and Technology, Fiscal Year 1994 Estimates," p. RD 9-37.

¹³¹ "Office of Aeronautics, Aeronautical Research and Technology, Fiscal Year 1995 Estimates," p. SAT 4-30

¹³² "Office of Aeronautics, Aeronautical Research and Technology, Fiscal Year 1997 Estimates," p. SAT 4-41.

In 1996, the objectives of the Terminal Area Productivity (TAP) initiative were expanded, in cooperation with the FAA, to include the development of critical air traffic technologies that would enable new U.S. air traffic capabilities and provide innovative concepts for countries with immature systems. The benefits of the Advanced Air Transportation Technology (AATT) initiative were reduced costs and a larger aviation market both domestically and abroad.¹³³



Figure 3-11. This photo shows the eight CRT displays on the Transport Systems Research Vehicle Simulator. The simulator was used as a research tool for projects such as the Cockpit Weather Information (CWIN) displayed on the center lower right CRT (NASA-LaRC photo EL-1996-00095).

¹³³ Ibid., p. SAT 4-35.

Center-TRACON Automation System (CTAS). Research for CTAS began in the late 1970s. In the early 1980s, Ames Research Center began adapting trajectory analysis studies that had been performed for on-board flight-management systems to the ground controller's point of view. The development of graphics-oriented computers inspired the idea of making tools available to controllers that would enable them to display trajectory information and make predictions conveniently. In the early 1990s, NASA and the FAA tested the CTAS software with live radar data at the Denver and Dallas/Fort Worth airports. They fine-tuned the software that would provide decision-making assistance to air traffic controllers by optimizing arrival traffic flow and generating advisories. The software underwent thousands of hours of simulation testing and extensive field evaluations.¹³⁴

Passive FAST (pFAST) and FAST were CTAS decision-support tools for terminal area air traffic controllers and were part of an automated system to manage terminal area traffic.¹³⁵ They provided advisories to help air traffic controllers manage arriving aircraft and achieve an accurately spaced traffic flow on final approach. Their goal was to increase airport capacity without compromising safety. The advisories recommended which runway and landing sequence to use. The system accurately predicted arrival times based on knowledge of the aircraft type, weather conditions, and airport landing procedure. The tool also advised air traffic controllers on how to accurately meet a schedule and maintain the aircraft separations required for safety.

¹³⁴ TRACON stands for Terminal Radar Approach Control. *NASA Aeronautics, Research and Technology Program Highlights*, NP 159, pp. 12–13. Also Katharine K. Lee and Beverly D. Sanford, "The Passive Final Approach Spacing Tool (pFAST) Human Factors Operational Assessment," 2nd USA/Europe Air Traffic Management R&D Seminar, December 1-4, 1998, 2, http://www.ctas.arc.nasa.gov/publications/papers/lee_12_98.pdf (accessed July 6, 2006).

¹³⁵ Passive FAST provided runway and sequence number advisories with the information displayed on the arrival controllers' radar displays. The "active" phase of FAST additionally displayed heading, speed, and turn advisories. Lee and Sanford, "The Passive Final Approach Spacing Tool (pFAST) Human Factors Operational Assessment," 2nd USA/Europe Air Traffic Management R&D Seminar, December 1-4, 1998, 2, http://www.ctas.arc.nasa.gov/publications/papers/lee_12_98.pdf (accessed July 6, 2006).

Typically, air traffic controllers added an extra buffer of approximately one-half mile to the FAA separation criteria. FAST and pFAST allowed controllers to safely reduce that buffer by 0.2–0.3 mile (0.3–0.5 kilometer), which substantially increased an airport’s capacity to handle arriving aircraft by perhaps as much as 20–30 percent while reducing arrival delay times by 20 percent.

In 1996, NASA tested pFAST at the Dallas/Fort Worth International Airport’s Terminal Radar Approach Control Facility. The automated system generated advisories for air traffic controllers to help them manage aircraft arrivals starting at about 200 miles (322 kilometers) from the airport and continuing to their final approach.¹³⁶

On February 15, 1999, pFAST began 16-hours-per-day operational use at Dallas/Fort Worth International Airport. This was a major milestone for the pFAST Free Flight Phase One effort as it demonstrated that pFAST could be independently adapted and run operationally by an FAA contractor without substantial NASA oversight or input. In the two weeks of operation, more than 80 percent of the possible arrival rushes were run using pFAST. Controller acceptance of the runway advisories was 96.9 percent, and acceptance of the sequence advisories was also high, although it was not specifically tracked. Air traffic controllers and airport TRACON management described the first week of operations as “very positive.” Controllers in the Dallas/Fort Worth tower reported that airport traffic balance was at an all-time high, and that rushes seemed to begin and end earlier, potentially pointing to reduced delays. Dallas/Fort Worth controllers also reported an increase in surface traffic operational efficiency due to the improved overall balance of traffic on the ground. During the next three years, only one software change to

¹³⁶ *Aeronautics & Space Transportation Technology; Three Pillars for Success: Turning Goals Into Reality, Annual Progress Report 1997–1998*, p. 34.

address improved sequencing of low-speed general aviation aircraft was required, and the resulting modification was transferred to Dallas/Fort Worth for operational use, with positive results.¹³⁷

Surface Movement Advisor (SMA). SMA increases awareness of traffic flow into an airport, giving ramp control operators precise touchdown times. This updated information helps airlines manage ground resources (e.g., gates, baggage handling, food services, refueling, and maintenance) at the terminal more efficiently. With information regarding an aircraft's identity and position in the terminal airspace, gate and ramp operators using SMA can reduce taxi delays.

The system provides aircraft arrival information to airline ramp towers and operation centers. This includes an aircraft's identity and position in TRACON airspace, which can be used to compute an aircraft's estimated time to touchdown. The shared situational awareness provided by SMA affords airlines greater efficiency and productivity with respect to aircraft arrivals in the terminal airspace and on the ground.¹³⁸

Development of the SMA Prototype System (ATL SMA) began in 1994. The design team, in conjunction with Ames Research Center, established the basic system requirements in December 1994. Field tests were conducted at Atlanta Hartsfield International Airport in 1995.¹³⁹ In February 1996, after system development, testing, and integration were completed, the tool was demonstrated to the airline industry. In June 1996, after further evaluations and field tests, Delta

¹³⁷ "Final Approach Spacing Tool," Center-TRACON Automation System, http://www.ctas.arc.nasa.gov/project_description/fast.html (accessed July 7, 2006).

¹³⁸ "SMA Overview," <http://sma.tc.faa.gov/overview.htm> (accessed July 7, 2006).

¹³⁹ *Aeronautics & Space Transportation Technology; Three Pillars for Success: Turning Goals Into Reality, Annual Progress Report 1997–1998*, pp. 34–35.

Air Lines began daily use of the system. The system was commissioned at the Atlanta Hartsfield Airport tower in January 1997. In 1998, other airports began to use the system. Feedback from the airlines that used SMA was very positive.

SMA consists primarily of a set of computers and software that electronically connects information gathered by the local airport authority that manages the airport's ramp areas, the airlines that manage the gates, and the FAA's air traffic controllers. SMA is the first automated system to provide all of the gathered information to each group, helping them to collaborate better on operational decisions. The system reduces group-operation bottlenecks, allowing planes to be serviced and dispatched more quickly. It has reduced airline taxi departure times by more than 1 minute per flight, benefiting passengers. With more than 1,000 departures each day from Atlanta, a savings of 1,000 minutes or more means a daily savings to the airlines of at least \$40,000 to \$50,000 in direct operating costs at that airport.¹⁴⁰

Taxiway Navigation and Situation Awareness (T-NASA) System. The T-NASA system was developed by Human Factors psychologists at Ames Research Center. It is a suite of cockpit displays that provide navigation and situational awareness information to pilots in order to increase the safety and efficiency of airport surface operations. Its goal is to safely get the aircraft from the gate to the runway, and from the runway to the gate, as efficiently as possible, even when visibility is poor.

¹⁴⁰ *Aeronautics & Space Transportation Technology; Three Pillars for Success: Turning Goals Into Reality, Annual Progress Report 1997–1998*, p. 35.

T-NASA consists of three components:

- The Taxi Head-Up Display (HUD), a glass visor in front of the cockpit windshield, shows the cleared taxi route in a “virtual reality” format and depicts the edges of the taxiway with a series of virtual “cones” and the centerline with virtual centerline markers. As the plane moves, the cones and markers move and change as if they were actual objects on the airport surface, so the pilot’s cleared route looks like a virtual highway on the ground.
- The Electronic Moving Map (EMM) on the instrument panel shows the current ground position of the pilot’s aircraft and other aircraft present. It depicts the pilot’s cleared route with a magenta ribbon. Both the pilot and copilot can determine their aircraft’s location with respect to the cleared route.
- The three-dimensional (3-D) audio Ground Collision Avoidance Warning (GCAW) system provides traffic warnings produced via virtual audio techniques. The warning sounds as if it emanates from the direction of the hazard, and greatly enhances a pilot’s awareness of potential traffic hazards.

The T-NASA system was designed following a human-centered design process. In total, more than 300 commercial pilots participated in part-task studies, high-fidelity simulations, and flight-test studies. These studies demonstrated that T-NASA

- eliminated hold location errors and failure to hold errors (compared to 20 percent errors without T-NASA);
- allowed increased taxi speeds (~16 percent faster than without T-NASA);
- eliminated taxi navigation errors in low-visibility and night conditions (compared to 17 percent errors without T-NASA);

- enabled better awareness of airport traffic;
- improved pilot–air traffic controller communications regarding clearance;
- improved captain–first officer intracockpit communications;
- helped determine the basis for cockpit standard operating procedures for surface operations.¹⁴¹

In the summer of 1997, a joint flight test was conducted at Atlanta Hartsfield International Airport under the NASA-FAA Low-Visibility Landing and Surface Operations (LVLASO) program to evaluate the HUD and EMM components of the T-NASA system (see figure 3-12). Langley Research Center conducted the integration of T-NASA into NASA’s 757 aircraft, and the FAA developed the airport surveillance and datalink technologies. Fifty-three flights were conducted under simulated low-visibility conditions by two NASA test pilots and four commercial pilots from different airlines. The pilots completed taxi trials with three different T-NASA configurations. Their reports indicated that T-NASA reduced overall taxi times by allowing for increased taxi speeds, less route-planning time, less time spent at confusing intersections, fewer stops while taxiing, improved situational awareness, and greater confidence of position on the airport surface. These subjective reports were supported by objective velocity data collected during the flight tests. All of the commercial pilots agreed that T-NASA technology would improve taxi safety, primarily by reducing the likelihood of incursions. T-NASA allowed the pilots to spend more time looking out the window and less time head-down consulting charts. Furthermore, pilots noted that T-NASA improved communications with

¹⁴¹ “HSCL Research: Taxiway Navigation and Situation Awareness System (T-NASA) Overview,” Human-Centered Systems Lab, <http://human-factors.arc.nasa.gov/ihi/hdsl/T-NASA.html> (accessed July 7, 2006). Also *Aeronautics & Space Transportation Technology; Three Pillars for Success: Turning Goals Into Reality, Annual Progress Report 1997–1998*, pp. 35–36

ground control and among crew members in that less communication was needed and communications were clearer.¹⁴²



Figure 3-12. This photograph was taken from the cockpit window of NASA's 757 research aircraft during flight demonstration of airport capacity and safety enhancement technologies at Hartsfield-Atlanta International Airport in August 1997. As the 757 approached the runway, computer-generated graphics outlined the correct runway and its precise location on a "head-up display" mounted between the pilot and the windshield (NASA-LaRC photo EL-1998-00111).

Affordable Travel

NASA's research focused on innovative design techniques and structural concepts to accomplish its goal of reducing the cost of air travel by 25 percent within 10 years and by 50 percent within 25 years. A number of research areas focused on reducing the cost of air travel, including

¹⁴² "Taxiway Navigation and Situation Awareness System (T-NASA) Empirical Research," Human-Centered Systems Lab, http://human-factors.arc.nasa.gov/ih/hcsl/T-NASA_studies.html (accessed July 7, 2006).

developing lightweight but strong composites, improving the aerodynamic qualities and reducing the weight of aircraft structures, developing and improving short-haul aircraft, and increasing fuel efficiency in all types of aircraft.

Fewer Parts. Reducing the number of parts and assembly steps in aircraft manufacturing is one way to reduce costs. Researchers at Langley Research Center, along with industry personnel, built and tested two metal panels to demonstrate the damage tolerance of an integrally stiffened fuselage structure. The panels were fabricated with curvature and stiffener spacing representing a typical fuselage structure. The process involved fewer parts than conventional construction, and potentially could also reduce the weight and fuel requirements of the aircraft.¹⁴³

Composites. NASA initiated the composites element in FY 1995. Its objective was to develop and verify at full scale the composite-structures technology. It also sought to verify the design concepts, structural materials, and manufacturing methods required to join composite wings to composite fuselages while saving weight and costs compared to conventional metal commercial transports.¹⁴⁴ The use of composites offered the potential to reduce airframe production and operating costs by reducing weight, increasing efficiency, and decreasing the cost of airframe structures.

A new machine for stitching composites became operational at Boeing's Stitched Composite Development Center in 1997. The Advanced Stitching Machine could stitch one-piece aircraft wing cover panels 40 feet (12.2 meters) long, 8 feet (2.4 meters) wide, and 1.5 inches (3.8

¹⁴³ *Aeronautics & Space Transportation Technology; Three Pillars for Success: Turning Goals Into Reality, Annual Progress Report 1997–1998*, p. 41.

¹⁴⁴ "Office of Aeronautics, Aeronautical Research and Technology, Fiscal Year 1995 Estimates," p. SAT 4-33.

centimeters) thick at rates of up to 3,200 stitches per minute. The process also eliminated the need for thousands of metal fasteners because the skin, stiffeners, intercostals, and spar caps could be stitched into one piece. The estimated cost savings from this technology compared to conventional aluminum-wing structures was 20 percent.¹⁴⁵

Integrated Wing Design. NASA initiated the integrated wing program in FY 1994. It focused on technology that treated aircraft aerodynamics in an integrated manner. Transport flight-test data were used to validate computational codes for evaluating high-lift systems. Additionally, a semispan, large-scale, transonic wind tunnel test evaluated propulsion airframe integration.¹⁴⁶ In FY 1995, the aerodynamic design cycle was completed and an industry baseline for performance measurement was established. Top-level integrated wing design objectives were defined as (1) a 50 percent reduction in the aerodynamic design cycle time leading to a one-year reduction in the overall development cycle, and (2) a 4 percent reduction in total aircraft-related operating costs compared with the baseline. Technical requirements to meet these objectives were defined.¹⁴⁷ In 1997, Langley Research Center performed wind tunnel tests on a blended wing body to evaluate the performance characteristics of the unconventional configuration and assess its potential. An aircraft with this configuration could potentially carry 800 passengers over 7,000 miles (11,265 kilometers) at a cruise speed of approximately 560 miles (901 kilometers) per hour, but it would require advanced flight-control systems.¹⁴⁸

¹⁴⁵ *Aeronautics & Space Transportation Technology; Three Pillars for Success: Turning Goals Into Reality, Annual Progress Report 1997–1998*, p. 38.

¹⁴⁶ “Office of Aeronautics, Aeronautical Research and Technology, Fiscal Year 1994 Estimates,” p. RD 9-37.

¹⁴⁷ “Office of Aeronautics, Fiscal Year 1997 Estimates,” p. SAT 4-42.

¹⁴⁸ *Aeronautics & Space Transportation Technology; Three Pillars for Success: Turning Goals Into Reality, Annual Progress Report 1997–1998*, p. 39.

Laminar Flow. The way in which air flows over the surface of an aircraft affects the amount of aerodynamic drag that is generated and is a major factor in how much fuel is used by the aircraft. Flow in which the fluid (air) near the aircraft surface moves in smooth-flowing layers is referred to as “laminar flow.” Laminar flow control is a technology that offers more potential for improvements in aircraft fuel usage, range, and endurance than any other known aeronautical technology.¹⁴⁹ The combination of natural laminar flow control, which results from a particular sweep of the leading edge of the lifting surfaces, and active laminar flow control, which is usually attained by removing a small amount of the boundary-layer air (the air closest to the surface) by suction through porous materials, is called hybrid laminar flow control (HLFC).¹⁵⁰

In 1987, NASA and the U.S. Air Force signed an MOU establishing a NASA-Air Force program to study and evaluate HLFC. They awarded a contract to Boeing for flight tests on its 757 prototype aircraft. The program was managed by Langley and costs were shared by the participants (NASA, the Air Force, and Boeing). Boeing modified a 22-foot (6.7-meter) section of the aircraft’s wing outboard of the left engine, and in 1990 began flight tests to assess the effectiveness of HLFC. Citing “better-than-expected finds” and “one of the most significant events in the history of boundary-layer control,” the team announced that laminar airflow was achieved over the first 65 percent of the upper surface of the modified wing section (measured from the leading edge to the trailing edge of the wing) on all flights during the five-month test period. The team stated that if the entire span of both wings could be modified, a reduction in total airplane drag of up to 10 percent or more could be realized, resulting in savings of millions

¹⁴⁹ Albert L. Braslow, *A History of Suction-Type Laminar-Flow Control with Emphasis on Flight Research*, Monographs in Aerospace History, No. 13 (Washington, DC: National Aeronautics and Space Administration, 1999), p. 1, <http://www.dfr.nasa.gov/History/Publications/PDF/Laminar.pdf> (accessed July 29, 2006).

¹⁵⁰ This is a vastly simplified explanation. See Braslow (above).

of dollars annually for the entire U.S. transport fleet.¹⁵¹ In all, 20 research flights were conducted in 1990 and 10 additional flights were performed in 1991. The demonstration showed that production-manufacturing technology could meet laminar-flow surface tolerance requirements, and that a practical HLFC system could be integrated into a commercial transport wing leading edge.¹⁵²

Following the 757 aircraft flight tests, Langley analyzed the benefits of HLFC for a representative advanced transport aircraft. The results indicated the HLFC-equipped aircraft burned 13 percent less fuel compared to a conventional transport. Boeing conducted its own analysis in 1991 and concluded that the total operating cost benefit projected for HLFC at fuel prices of the time was positive but insufficient to warrant the risks involved in applying HLFC to commercial aircraft. Not all conditions had been considered, and HLFC had not been applied to aircraft larger than the 757. No further tests of the concept were made.¹⁵³

In FY 1994, knowledge of laminar flow was applied to wing design. A large laminar-flow swept-wing model was designed and fabricated, establishing the state of the art and identifying deficiencies in current methods for designing wings and high-lift devices. The next year, testing of the laminar-flow model was completed in the 8-foot transonic-pressure wind tunnel at Langley. Improvements were made in wing-design methods based on identified deficiencies, and a cost-benefit analysis of the impact of wing-design concepts and methods on aerodynamic

¹⁵¹ “Flight Tests Prove Concept for Jetliner Fuel Economy, *NASA News Release 90-115*, August 23, 1990, <ftp://ftp.hq.nasa.gov/pub/pao/pressrel/1990/90-115.txt> (accessed July 27, 2006).

¹⁵² Joseph R. Chambers, *Innovation in Flight; Research of the NASA Langley Research Center on Revolutionary Advanced Concepts for Aeronautics* (Washington, DC: NASA SP-4539, 2005), pp. 142–143, 146.

¹⁵³ Chambers, *Innovation in Flight Research*, pp. 146–149.

design cycle time, aircraft performance, and costs was made.¹⁵⁴ In FY 1995, the high-Reynolds-number test phase on the 10-foot-chord hybrid laminar-flow control swept wing was completed on time and within budget, and the data were transferred to NASA's industry partners. The final design review for the high-wing transport scale model was completed.¹⁵⁵

Reducing Skin Friction. One of the most challenging areas of research in aerodynamics is the reduction of skin friction, especially for turbulent flow. Reducing skin friction leads to less drag. For aircraft, less drag can lead to less fuel burned or to a greater flight range for a fixed amount of fuel. Many techniques and methods have been tried; however, none have significantly reduced skin friction in the flight environment.

The Microblowing Technique (MBT), an innovative technique to reduce skin friction on both aircraft and marine vehicles, was invented in 1993. With MBT, an extremely small amount of air (or water in the case of marine vehicles) is blown vertically at a surface through very small holes. Microblowing reduces the surface roughness and changes the flow velocity profile on the surface, thereby reducing skin friction. In 1995, a Phase I proof-of-concept experiment was conducted in Lewis Research Center's Advanced Nozzle and Engine Components Test Facility. In 1996, a Phase II experiment to evaluate the increased pressure drag penalty associated with this technique was conducted in the same facility. In September 1997, a program conducted jointly by NASA Lewis, United Technologies Research Center, Northrop Grumman Corporation, and Pratt & Whitney was completed. A 30-inch (76-centimeter) engine nacelle with an MBT skin was tested in United Technologies' wind tunnel. The results of the experiment

¹⁵⁴ "Office of Aeronautics and Space Technology," Fiscal Year 1996 Estimates, http://www.hq.nasa.gov/office/budget/fy96/sat_4.html (accessed June 19, 2006).

¹⁵⁵ "Office of Aeronautics," Fiscal Year 1997 Estimates, p. SAT 4-42.

indicated that skin-friction reductions of 50–70 percent over portions of the nacelle could be achieved with the addition of only small amounts of blowing air.¹⁵⁶

High-Stability Engine-Control (HISTEC) System. The advanced HISTEC system sponsored and managed by Lewis Research Center was expected to significantly increase future propulsion system performance in both military and commercial turbine engines. The system (also known as Distortion Tolerant Control) underwent flight tests at Dryden Flight Research Center on a highly modified F-15 jet that explored a variety of advanced control system technologies. It incorporated an aircraft-mounted, high-speed processor that sensed changes in airflow at the front of the engine and allowed the system to command trim changes to the engine automatically to accommodate changing distortion conditions. The primary benefit of Distortion Tolerant Control was its ability to set the margin of stability on line and in real time. This could allow the built-in stall margin to be reduced, which could then be “traded” for decreased weight, increased performance, or both. The result would be higher-performance military aircraft and more fuel-efficient commercial aircraft. Pratt & Whitney, Boeing Phantom Works, and the Air Force Wright Laboratories partnered in the research.¹⁵⁷ On March 27, 1996, NASA began flight-testing a new thrust-vectoring concept on the F-15 research aircraft to improve performance and aircraft control (see figure 3-13). The new concept could lead to significant increases in performance of both civil and military aircraft flying at subsonic and supersonic speeds.

¹⁵⁶ *Aeronautics & Space Transportation Technology; Three Pillars for Success: Turning Goals Into Reality, Annual Progress Report 1997–1998*, pp. 40–41. Also “Microblowing Technique Demonstrated To Reduce Skin Friction,” <http://www.grc.nasa.gov/WWW/RT1997/5000/5850hwang.htm> (accessed July 7, 2006).

¹⁵⁷ *Aeronautics & Space Transportation Technology; Three Pillars for Success: Turning Goals Into Reality, Annual Progress Report 1997–1998*, p. 40.



Figure 3-13. The F-15 ACTIVE in flight over the Mojave desert during a High Stability Engine Control (HISTEC) flight. The twin-engine F-15 is equipped with new Pratt & Whitney nozzles that can turn up to 20 degrees in any direction, giving the aircraft thrust control in the pitch and yaw directions. NASA pilot Rogers Smith and photographer Carla Thomas fly the F-18 chase to accompany the flight (NASA photo EC97-44177-15).

Short-Haul Aviation (General Aviation/Commuter)

In FY 1994, NASA conducted an economic analysis of the status of the general aviation (GA) industry and the areas in which technology could contribute to its revitalization.¹⁵⁸ NASA, in cooperation with the U.S. aviation industry and the FAA, began two major initiatives—the General Aviation Propulsion (GAP) program and the Advanced General Aviation Transport

¹⁵⁸ “Office of Aeronautics and Space Technology Fiscal Year 1996 Estimates,” http://www.hq.nasa.gov/office/budget/fy96/sat_4.html (accessed June 19, 2006).

Experiments (AGATE) consortium—to create the technological basis for revitalizing this segment of air travel.

The GAP program was a partnership between industry and the FAA to develop new, low-cost propulsion systems. GAP researchers planned to develop an intermittent combustion engine for entry-level GA aircraft and a new turbofan engine for higher-performance GA aircraft.

Lewis Research Center teamed with Teledyne Continental Motors and its industry partners to develop, fabricate, and test an extremely advanced intermittent combustion piston engine. The engine incorporated a horizontally opposed, four-cylinder, liquid-cooled, two-stroke compression ignition (diesel) engine. Such engines are usually very efficient and reliable but relatively heavy. The new design used lightweight construction techniques and produced 200 horsepower at an engine weight comparable to that of current 200-horsepower aircraft engines. The engine used jet fuel rather than leaded gasoline and was about 25 percent more fuel-efficient than gasoline engines. Its single-level power-control operation allowed the pilot to give full attention to flying the aircraft.

NASA teamed with Williams International and its industry partners to develop a new low-cost turbofan engine, designated FJX-2. Williams also commissioned Scaled Composites to build the V-Jet II aircraft to be a testbed for demonstrating the FJX-2 engine. The new design, technologies, and manufacturing methods used for FJX-2 resulted in an engine that was much

less costly, as well as quieter and more fuel-efficient, than existing turbine engine propulsion systems.¹⁵⁹

The AGATE consortium began in 1994 to develop affordable new technologies as well as industry standards and certification methods for airframes, cockpits, flight training systems, and airspace infrastructure for future single-pilot, four-to-six-place, near all-weather light airplanes. The consortium was a cost-sharing partnership among more than 70 members from industry, academia, the FAA, and other government agencies. NASA and AGATE demonstrated a number of NASA technologies for navigation, weather, terrain, traffic, and system-status information systems. These cockpit systems technologies were developed by a group of 10 companies led by Rockwell Collins and AvroTec. The experiments resulted in the first successful combination of a number of new technologies in a single aircraft. An experimental-certificate Beech Bonanza F33C owned and modified by Raytheon Aircraft served as an “integration platform” testbed for the new technologies being developed by AGATE (see figure 3-14).¹⁶⁰

¹⁵⁹ *Aeronautics & Space Transportation Technology; Three Pillars for Success: Turning Goals Into Reality, Annual Progress Report 1997–1998*, pp. 54–55.

¹⁶⁰ *Ibid.*, pp. 54–56.



Figure 3-14. This photo illustrates an AGATE advanced concept airplane. The pusher propeller-driven configuration seats four to six people (including the pilot) in a midwing, three-surface, twin-tailboom configuration. The design concept incorporates natural laminar flow, ice protection, winglets, and stall-departure-resistant flight dynamics (NASA LaRC photo EL-1996-00214).

Civil Tiltrotor (CTR). A tiltrotor aircraft has two major benefits for civil use because of its ability to take off and land vertically: it can increase an airport’s capacity, and it can shorten delays by significantly reducing door-to-door trip times for passengers by circumventing ground and air congestion. Expanding capacity and reducing runway congestion at the busiest airports by permitting some short-haul traffic (trips of less than 500 miles [805 kilometers]) to shift to tiltrotors would free runway space for larger aircraft.¹⁶¹

¹⁶¹ “Tiltrotor,” <http://www.globalsecurity.org/military/systems/aircraft/tiltrotor.htm> (accessed July 27, 2006).

In the late 1980s and 1990s, NASA worked to develop the CTR, a direct descendant of the XV-3, XV-15, and V-22 Osprey tiltrotor aircraft.

Research into tiltrotor technology had begun in the 1940s. The XV-3, built in 1953, flew until 1966. It proved the fundamental soundness of the tiltrotor concept and provided data about the technical improvements needed for future designs. The XV-15 Tiltrotor Research Aircraft began development in 1972. One of the most versatile aircraft ever designed, the aircraft combined standard aircraft cruise flight with vertical takeoff and landing (VTOL) and short takeoff and landing (STOL) capabilities. Two XV-15s were tested. One aircraft was used in a flight research program at Ames Research Center. The second was operated by the Bell Helicopter Company in Arlington, Texas, and was used for tiltrotor development and military and civil demonstrations. Funded by NASA and the U.S. Army, the XV-15s served as testbeds to refine tiltrotor concepts, prove new components and systems, and demonstrate the controllability, performance, and community compatibility of tiltrotors.¹⁶²

In 1981, using experience gained from the XV-3 and XV-15, Bell Helicopter and Boeing Helicopters began developing the V-22 Osprey, a twin-turboshaft military tiltrotor aircraft.¹⁶³ The first flight of the Osprey took place on March 19, 1989, at Bell's Flight Research Center in Texas, the site of the first XV-15 flight 12 years earlier. Five full-scale development aircraft were completed. Although two crashed and were destroyed during flight tests (one crash killed all on board), it was determined "that these accidents were not due to the inherent characteristics

¹⁶² "XV-15 Tiltrotor Research Aircraft," NASA Ames Research Center Simulation Laboratories, <http://www.simlabs.arc.nasa.gov/library/tiltrotor/ctr20th.html> (accessed July 28, 2006).

¹⁶³ "XV-15 Tiltrotor Research Aircraft," <http://www.simlabs.arc.nasa.gov/library/tiltrotor/ctr20th.html> (accessed July 28, 2006).

of this vehicle type,” and the program continued. On September 8, 1999, the first production V-22 took part in a demonstration at the Pentagon for Secretary of Defense William S. Cohen. In late 1999, the V-22 Osprey underwent operational testing by the U.S. Navy.¹⁶⁴

The development of the V-22 Osprey and the initiation of flight-testing encouraged tiltrotor advocates to press for civil application of this new type of aircraft. FAA- and NASA-funded studies showed that tiltrotor aircraft had a potential worldwide market and could benefit both manufacturers and operators economically. In late 1992, the study results were brought to the attention of Congress, which, in the Airport and Airway Safety, Capacity, Noise Improvement, and Intermodal Transportation Act of 1992, directed the Secretary of Transportation to establish a Civil Tiltrotor Development Advisory Committee (CTRDAC) to examine the costs, technical feasibility, and economic viability of developing CTR aircraft. The CTRDAC was also to consider issues associated with integrating CTR aircraft into the national transportation system and assess the resulting national economic benefits.¹⁶⁵ Furthermore, the Committee was charged with determining the required additional research and development and the regulatory changes needed to integrate the CTR into the transportation system, and how CTR aircraft and related infrastructure development costs should be allocated between government and industry.¹⁶⁶

The findings of the Committee, issued in December 1995, stated that the CTR was technically feasible and could be developed by U.S. industry. However, additional research and development

¹⁶⁴ Martin D. Maisel, Demo J. Giulianetti, and Daniel C. Dugan, *The History of the XV-15 Tilt Rotor Research Aircraft: From Concept to Flight*, Monographs in Aerospace History, No. 17 (Washington, DC: NASA SP-2000-4517, 2000), pp. 107–108.

¹⁶⁵ *Airport and Airway Safety, Capacity, Noise Improvement, and Intermodal Transportation Act of 1992*, Public Law 102-581, 102nd Congress, 2nd sess., October 31, 1992.

¹⁶⁶ Maisel, Giulianetti, and Dugan, pp. 110–111.

and infrastructure planning were needed before industry could make a CTR production decision. Also, under the assumptions made during the study, it was concluded that a CTR system could be economically viable and operate profitably without government subsidies in heavily traveled air corridors. The CTR, the Committee found, could reduce airport congestion, create jobs, and positively affect the balance of trade.¹⁶⁷ The Committee recommended that an integrated CTR aircraft and infrastructure research, development, and demonstration program be conducted through a government-industry partnership, with costs shared by both. Work should begin on regulatory and certification issues and on changes to the air traffic control system to safely and effectively use the capabilities of the CTR.¹⁶⁸

The CTR series had begun in 1989 following military-focused air combat investigations using a simulation model of the XV-15 and the Ames Simulation Laboratory in 1988–1989. Until 1994, these tiltrotor activities were included in NASA’s rotorcraft R&T base program. In 1994, the CTR program began as a subelement of the Advanced Subsonic Transport initiative.

The CTR program, which included 10 primary CTR simulation experiments conducted in the Ames Vertical Motion Simulator (VMS), addressed the fundamental research issues underlying the critical technologies required for civilian 40-passenger tiltrotor aircraft. The program also conducted moderate- to large-scale wind tunnel tests of tiltrotor models. The test data confirmed the performance and aeroacoustic prediction methodologies needed to investigate and demonstrate advanced CTR and high-speed rotorcraft technologies.

¹⁶⁷ Ibid., p. 111.

¹⁶⁸ Ibid., p. 111.

The first CTR experiment (CTR-1) in October 1989 was conducted at the request of and in coordination with the FAA to investigate issues regarding steep instrument approaches (6–25 degrees) for civil operations using a large, 40,000-pound tilt-rotor model. In the next pair of experiments (CTR-2 and CTR-3), researchers explored a more limited range of approach angles and began developing appropriate cockpit displays and guidance. They developed instrument guidance to support Instrument Flight Rules (IFR) approach and landing operations.¹⁶⁹

During this time, NASA and the U.S. Army increased their ability to test tiltrotor configurations. In 1991, Ames, Langley, and the U.S. Army jointly initiated the development of two modular, hardware-compatible test stands to test tiltrotor models in two different configurations: an isolated rotor configuration located at the Duits-Nederlandse Wind Tunnel in the Netherlands, and a full-span model located at the National Full-Scale Aerodynamic Complex at Ames. The two configurations together were called the Tilt Rotor Aeroacoustic Model (TRAM).¹⁷⁰

The CTR-4 experiment in November–December 1993 shifted the focus to a more complete investigation of approach and landing beginning from a cruise configuration of the aircraft (airplane mode). The experiment featured the development of terminal-area operations suitable for current aircraft designs, with a particular concern for single-engine failures. It emphasized the development of conversion procedures, a discrete nacelle control system, and airport operations for vertical-flight aircraft (vertiports) as suggested by then-current thinking on vertiport design. The vertiports were placed in a visual scene based on the San Francisco Bay Area at three sites

¹⁶⁹ William Decker, aeronautical engineer, e-mail message to author, July 31, 2006.

¹⁷⁰ Larry A. Young, “Tilt Rotor Aeroacoustic Model (TRAM): A New Rotorcraft Research Facility” (paper presented at the American Helicopter Society International Meeting on Advanced Rotorcraft Technology and Disaster Relief, Gifu, Japan, April 21-23, 1998).

that could have been developed for that purpose, lending additional “authenticity” to the simulation and helping promote discussions among researchers, FAA regulators, and industry representatives.¹⁷¹

As the project progressed, it concentrated more on noise-abatement issues. Concurrently with the CTR simulation experiments, in FY 1994, three- and four-bladed wind tunnel tests in the 14- by 22-foot (4.3- by 6.7-meter) Subsonic Tunnel at Langley were used to evaluate CTR noise-reduction concepts. These tests showed significant variations in both noise level and directivity as a function of rotor operation condition. They also provided acoustic and aerodynamic data to establish baselines and trends for noise and aerodynamic performance, and viable noise-reduction concepts were identified for further research.¹⁷² Three acoustic flight tests in 1995, 1997, and 1999 used the XV-15 to evaluate the noise-reduction potential for tiltrotor aircraft during terminal-area operations. At a remote site in Texas, a NASA-U.S. Army-Bell Helicopter team evaluated noise reduction during the flight tests by altering the nacelle angle, airspeed, and altitude. The test results showed that no single approach profile was best for all landing sites; rather, the approach profile needed to be tailored to the type of landing site used (such as the top of a building or a more remote site).¹⁷³

¹⁷¹ William Decker, aeronautical engineer, e-mail to author, July 31, 2006.

¹⁷² David A. Conner et al., “NASA/Army/Bell XV-15 Tiltrotor Low Noise Terminal Area Operations Flight Research Program,” AIAA-2000-1923, American Institute of Aeronautics and Astronautics, 2. Also “Fiscal Year 1996 Estimates, Office of Aeronautics and Space Technology,” http://www.hq.nasa.gov/office/budget/fy96/sat_4.html (accessed June 19, 2006).

¹⁷³ Conner et al., p. 21.

The Short Haul Civil Transport (SHCT) project began in 1994.¹⁷⁴ This project addressed the critical barrier to including CTR operations in the National Transportation System: excessive noise during the approach to landing (called blade vortex interaction [BVI] noise). The project's goal was to attain a noise level 12 decibels below that of the military V-22 Osprey.¹⁷⁵ The fifth CTR experiment (November–December 1994) investigated one-engine inoperative terminal-area operations (takeoff and landing). CTR-6, in March–April 1996, continued the terminal-area operations investigations with a new focus on more complex approach profiles intended for noise abatement.¹⁷⁶ A Variable Diameter Tiltrotor simulation experiment was conducted with Sikorsky Aircraft in the VMS in September–October 1996.

The CTR-7 VMS experiment in November–December 1997 sought to further develop terminal area guidance for complex operations, including guided takeoff and go-around. Control system issues, particularly for the power-engine control, placed this effort in the “developmental” category. This experiment also marked the introduction of the NASA baseline CTR transport model and a new side-by-side transport simulation cockpit that was developed jointly by the NASA tiltrotor and HSCT programs. This cockpit enabled researchers to investigate crew interactions in a typical civil transport cockpit.

Further acoustic wind tunnel tests were conducted in 1998 in Langley's 14- by 22-foot (4.3- by 6.7-meter) Subsonic Tunnel to evaluate industry-developed low-noise tiltrotor designs using a

¹⁷⁴ “Short Haul Civil Tiltrotor—The Story of Technology Transfer,” *NASA Aeronautics News* 3, no. 2 (June 14, 2002), http://www.aero-space.nasa.gov/news/vol3_iss2/tiltrotor.htm (accessed August 28, 2006).

¹⁷⁵ John Zuk, “Creating Friendlier Skies; Noise Reduction Project Enhances Acceptance of the Short-Haul Civil Tiltrotor.”

¹⁷⁶ “XV-15 Tiltrotor Research Aircraft,” NASA Ames Research Center Simulation Laboratories, <http://www.simlabs.arc.nasa.gov/library/tiltrotor/ctr20th.html> (accessed July 28, 2006).

one-quarter-scale isolated rotor. Two versions of a Sikorsky Variable Diameter Tiltrotor (VDTR) and two Boeing five-bladed advanced rotor configurations were compared with a “baseline” V-22 rotor system. The results indicated that the Boeing five-blade rotors substantially reduced noise for some conditions, while the Sikorsky VDTR configurations met or exceeded the SHCT goal of a 6-decibel noise reduction for most conditions tested.¹⁷⁷

The CTR-8 VMS experiment in April–May 1999 marked the sole use of an XV-15 simulation model during this series of experiments. The model was used to assist noise-abatement operation developments in coordination with flight tests. It also provided a means to work with researchers from Georgia Technological University who were formulating advanced control methods for a tiltrotor. Finally, a preliminary investigation was conducted to examine control law adaptations for the use of a sidestick controller instead of the traditional center stick. The results of this experiment fed into a later XV-15 noise-abatement flight operations flight test at Bell Helicopter in September 1999, conducted by the same Ames-Langley-Bell team that did the 1997 tests.

The final two CTR experiments, conducted in October–November 2000 and July–August 2001, pushed civil terminal-area operations investigations toward a more complete “full-mission” focus, with competing air traffic, vectoring diversions, and simultaneous, noninterfering operations at a vertiport conceptually located atop the parking structure at San Francisco International Airport. The objective was to develop and demonstrate flight operations at a congested hub airport that could be conducted without interfering with conventional large

¹⁷⁷ Conner et al., p. 2.

transport aircraft. The tiltrotor operations were designed to minimize noise while maintaining the desired level of safety.¹⁷⁸

The SHCT program concluded with the last two simulation experiments in 2000 and 2001.

High-Speed Transport

One area identified for aeronautics research was the potential for using supersonic aircraft to travel to Pacific Rim countries from the United States more quickly than was currently possible. In the mid-1980s, NASA asked McDonnell Douglas and Boeing to conduct studies to define the potential market for a next-generation supersonic airliner, and the engineering advances needed to make it financially successful and environmentally safe. McDonnell Douglas studied a Mach 3.2 design that could carry approximately 300 passengers a distance of 7,500 miles (12,070 kilometers). Boeing studied a Mach 2.4 concept that could transport 250 passengers up to 5,800 miles (9,334 kilometers). The studies, released in late 1989, concluded that an economically viable HSCT could be built beginning around the year 2000 if noise and emission problems could be resolved satisfactorily and the vehicle's speed was limited to between Mach 2 and Mach 3.2.¹⁷⁹ They predicted that transpacific air travel would increase fourfold by 2000 and the number of transatlantic passenger trips would double. However, both studies found that substantial demand for an advanced supersonic transport would occur only if the plane had no harmful atmospheric effects and met allowable airport noise standards. The transport also needed to be economically competitive with future long-distance subsonic airliners.¹⁸⁰

¹⁷⁸ William Decker, e-mail message to author, July 31, 2006.

¹⁷⁹ Erik M. Conway, *High Speed Dreams; NASA and the Technopolitics of Supersonic Transportation, 1945–1999* (Baltimore: Johns Hopkins University Press, 2005), p. 220.

¹⁸⁰ *NASA Aeronautics, Research and Technology Program Highlights*, NP 159, p. 23.

High-Speed Research (HSR) Program. In 1990, NASA initiated the HSR program as a follow-on to the Boeing and McDonnell Douglas studies. The goal of this focused technology development program was to identify and develop technical and economically feasible solutions to the environmental concerns surrounding supersonic civil transport. It ran from 1990 until it was canceled at the end of FY 1999, and cost approximately \$1.8 billion.¹⁸¹ The program initially received bipartisan support from Congress and funding of \$25 million in the FY 1990 budget. At the time, Congress cited the importance of the initiative to the American aircraft industry and the threat to U.S. aeronautical leadership posed by foreign advances in aeronautics.¹⁸² Langley Research Center led the multicenter program with support from Dryden, Ames, and Lewis. Langley was responsible for policy and program implementation, project planning and funding allocation, systems engineering and integration, and direct contractor interface and management.¹⁸³ It also led airframe-related research and advanced flight-deck development activities. Ames provided significant support directly to Langley in advanced flight-deck development, computer modeling and simulation, and economic analysis. Lewis managed propulsion efforts, and Dryden provided support for flight-related activities, including the F-16-XL and Environmental Research Aircraft and Sensor Technology (ERAST) program.¹⁸⁴ Industry partners included advanced flight-deck, airframe, and propulsion-system companies that were responsible for researching, developing, and validating specific technologies; developing and assessing a next-generation HSCT concept and configuration; and conducting associated

¹⁸¹ Conway, p. ix.

¹⁸² “Fiscal Year 1991 Estimates, Office of Aeronautics and Space Technology,” p. RD 12-36. Also Conway, pp. 221–222.

¹⁸³ “Office of Aeronautics, Aeronautical Research and Technology,” Fiscal Year 1997 Estimates, p. SAT 4-28.

¹⁸⁴ Joseph R. Chambers, *Innovation in Flight; Research of the NASA Langley Research Center on Revolutionary Advanced Concepts for Aeronautics* (Washington, DC: NASA SP-4539, 2005), p. 50.

tasks, such as mission analysis and database development, as well as system-level integration of the developing advanced technologies.¹⁸⁵

The program consisted of two phases. Phase I of the program focused on environmental concerns, particularly problems relating to ozone depletion, airport and community noise, and sonic boom. Phase II, which began in 1994, focused on developing the advanced technologies needed to ensure the economic viability of the aircraft.

To retain Congress' support for the project, NASA needed to prove that the HSCT was ozone-neutral and could meet current airport noise requirements, and that the sonic boom the aircraft generated could be made acceptable for flights over land or water. From 1989 to 1991, researchers tested the most reliable atmospheric computer models against existing atmospheric data to calculate the effects of emissions by a high-speed transport fleet. Although the results varied, calculations showed there were potential operating areas in the lower stratosphere where reduced engine emissions would deplete ozone by less than 1 percent. NASA used ER-2 aircraft and a modified DC-8 jetliner to collect improved stratospheric measurements. In late 1991, an ER-2 and DC-8 acquired the first ozone data geared specifically to the HSR program as an adjunct to the Airborne Arctic Stratospheric Expedition II, a polar-ozone mapping project.¹⁸⁶ In FY 1995, the first phase of the Atmospheric Effects of Stratospheric Aircraft flight campaign and analysis was completed. This study also used the NASA ER-2 high-altitude aircraft carrying a full complement of atmospheric sampling instrumentation. The instruments obtained new observations to diagnose the chemistry, physics, and fluid motion of air in the low stratosphere.

¹⁸⁵ "Office of Aeronautics and Space Technology," Fiscal Year 1996 Estimates, http://www.hq.nasa.gov/office/budget/fy96/sat_4.html (accessed June 19, 2006).

¹⁸⁶ *NASA Aeronautics, Research and Technology Program Highlights*, NP 159, p. 26.

Enhancements to atmospheric models were used to assess the potential environmental effects of a fleet of HSCTs, as well as emission scenarios for a 1,000-aircraft fleet.¹⁸⁷ The results from this flight campaign and from other studies by industry and NASA provided convincing evidence that advanced low-emission engines would have virtually no impact on stratospheric ozone, and that advanced technology could solve the airport noise problem.¹⁸⁸ However, research on achieving acceptable noise levels resulted in configurations that had a lower boom but were not economically viable; thus, no solution to the sonic-boom issue was forthcoming and supersonic flights were limited to over water. Subsequent sonic-boom research was directed toward understanding the effects of sonic booms on marine animals, and determining how to avoid exposing humans and animals to the booms. Questions also remained about the aircraft's economic viability and the acceptability of the advanced technology costs.¹⁸⁹

In an effort to reduce the sonic boom, beginning in 1990, researchers designed Mach 2 and Mach 3 twisted wing-body-nacelle concepts to produce tailored “flat-top” or “ramp”-type signatures. Wind tunnel tests of these models encountered unpredicted shocks coming from the flow-through nacelles. The next series of tests in 1991 used nonlinear CFD methods to a greater extent to compare directly with wind tunnel data. The use of CFD had become more necessary as wind tunnel models became larger in order to incorporate increasingly realistic features such as twist and camber, and nacelles.¹⁹⁰ During 1995, a NASA team at Dryden conducted flight tests near Edwards Air Force Base with an SR-71 aircraft to study sonic-boom characteristics (see figure 3-15). During these missions, an F-16XL probed the shock waves generated by the SR-71, while a

¹⁸⁷ “Office of Aeronautics, Aeronautical Research and Technology,” Fiscal Year 1997 Estimates, p. SAT 4-32.

¹⁸⁸ “Office of Aeronautics and Space Technology,” Fiscal Year 1994 Estimates, p. RD 9-31.

¹⁸⁹ Chambers, *Innovation in Flight Research*, p. 52. Also “High Speed Research,” Office of Aero-Space Technology FY 1998 Technical Accomplishments, January 22, 1999.

¹⁹⁰ Chambers, *Innovation in Flight Research*, p. 55.

NASA F-18 and YO-3A, flying at lower altitudes, were used to augment ground-based measurements from the same shock wave and help in the analysis.¹⁹¹



Figure 3-15. The single-seat F-16XL (in the foreground) flies in formation with an SR-71A on one of the flights in the sonic boom research program conducted by Dryden Flight Research Center (NASA-DFRC photo EC95-43024-5).

The second phase of the HSR program, which ran concurrently with Phase I, began in 1994.¹⁹²

Phase II focused on the technology advances needed to ensure economic viability and environmental compatibility. Its objective was to develop and validate, in cooperation with U.S. industry, designs, design methodologies, and manufacturing-process technologies for subsequent

¹⁹¹ Ibid., p. 56.

¹⁹² “High Speed Research,” *Spinoff* 1995, <http://neurolab.nasa.gov/er/seh/pg34s95.html> (accessed July 24, 2006).

application by industry in future HSCT programs.¹⁹³ The technology advances identified for economic viability included reducing weight in all areas of the baseline configuration, trimming the baseline airframe, minimizing drag, improving critical engine components, and developing advanced control systems, flight-deck instrumentation, and displays.¹⁹⁴ In August 1994, NASA awarded Boeing and McDonnell Douglas a \$440 million contract to develop technologies as a team in the areas of airframe technologies for aerodynamics, flight systems, and materials and structures for the HSCT. The Critical Propulsion Components contract went to a General Electric-Pratt & Whitney team, and the Advanced Flight Deck contract was awarded to Honeywell International. These teaming arrangements enabled the companies to reduce duplication and costs and accelerate research.¹⁹⁵

In December 1995, NASA chose a single aircraft concept—the Technology Concept Aircraft (TCA)—to focus the intensive technological development planned for the next three years of the program. The TCA was not an actual design or airplane that would be built; rather, it was a common reference point for HSR technology development. The TCA evolved from separate Boeing and McDonnell Douglas HSCT designs.¹⁹⁶ In July 1996, researchers at Langley tested the initial wind tunnel model of the TCA in the Langley Unitary Plan Wind Tunnel (UPWT). Experimental results confirmed the analytical supersonic optimized nonlinear aerodynamic design of the twist and camber of the double-delta wing. The nonlinear optimization of the total

¹⁹³ “Office of Aeronautics and Space Technology,” Fiscal Year 1994 Estimates, p. RD 9-32. Also “Fiscal Year 1996 Estimates, Office of Aeronautics and Space Technology,” http://www.hq.nasa.gov/office/budget/fy96/sat_4.html (accessed June 19, 2006).

¹⁹⁴ Chambers, p. 54.

¹⁹⁵ “Boeing, McDonnell Douglas Awarded Technology Contracts,” Dryden X-Press, August 1994, <http://www.dfrc.nasa.gov/Newsroom/X-Press/xp-94-08.html> (accessed June 8, 2006). Also “Office of Aeronautics and Space Technology,” Fiscal Year 1996 Estimates, http://www.hq.nasa.gov/office/budget/fy96/sat_4.html (accessed June 19, 2006).

¹⁹⁶ “NASA’s High-Speed Research Program, Developing a Future Supersonic Passenger Jet,” NASA Facts Online, FS-1998-05-15-LaRC, May 1998, <http://oea.larc.nasa.gov/PAIS/HSR-General.html> (accessed July 24, 2006).

configuration continued over the next two years, leading to improvements over linear optimization methods.¹⁹⁷ Later wind tunnel tests using the aircraft took place in Langley's 16-foot transonic tunnel (see figure 3-16).



Figure 3-16. This photo shows a 1.5 percent High-Speed Research Technology Concept Aircraft (TCA) baseline aft body model in Langley's 16-foot transonic tunnel (NASA photo EL-1999-00196).

The technological advances required to ensure the economic viability of an HSCT included reducing the weight, trimming the baseline airframe, and minimizing drag. The benefits of laminar flow control included increased range, improved fuel economy, and reduced weight—all by-products of reduced drag. Wind tunnel, computational, and flight studies of supersonic

¹⁹⁷ *Aeronautics and Space Report of the President, Fiscal Year 1996 Activities*, (Washington, DC: National Aeronautics and Space Administration, no date), p. 46.

laminar flow control (SLFC) were performed in an effort to improve cruise efficiency for HSCT configurations. Boeing and McDonnell Douglas conducted analyses to determine the potential mission and economic benefits of SLFC. Dryden used an F-16XL prototype aircraft to conduct exploratory investigations of laminar-flow technology during 1992. Results from the SLFC experiment on the F-16XL demonstrated that wing suction at supersonic speeds could significantly reduce drag and thus offer a potential 6 percent reduction in HSCT gross takeoff weight.¹⁹⁸ In the spring of 1992, Boeing began working with Langley, Dryden, Rockwell, and McDonnell Douglas on an HSR project for designing and testing a hybrid SLFC glove on a second F-16XL aircraft. The glove covered about 75 percent of the upper wing surface and 60 percent of the wing's leading edge. Air was sucked through more than 10 million tiny laser-drilled holes in the glove by means of a manifold system with 20 valves. The glove was instrumented to determine the extent of laminar flow and measure other variables, such as the acoustic environment, that might affect laminar flow in various flight conditions. Wind tunnel tests in Langley's UPWT in 1994 verified design pressure distributions for the flight experiments and provided simulator coefficients for stability and control investigations (figure 3-17). The flight-test portion of the program ended November 25, 1996, after 45 flights. It demonstrated that laminar airflow could be achieved over a major portion of a wing at supersonic speeds with the use of a suction system.¹⁹⁹ However, based on the results of the SLFC flight tests, the planners decided not to incorporate this technology into the baseline airplane because it involved too many technical risks and would have an extensive impact on the system.²⁰⁰

¹⁹⁸ "Fiscal Year 1998 Estimates, Office of Aeronautics and Space Transportation Technology," p. SAT 4.1-29.

¹⁹⁹ Chambers, *Innovation in Flight Research*, pp. 155–156.

²⁰⁰ "Fiscal Year 1998 Estimates, Office of Aeronautics and Space Transportation Technology," p. SAT 4.1-29. Also "Aeronautics and Space Transportation Technology Enterprise FY 1999 OMB Budget Estimate," p. 18.

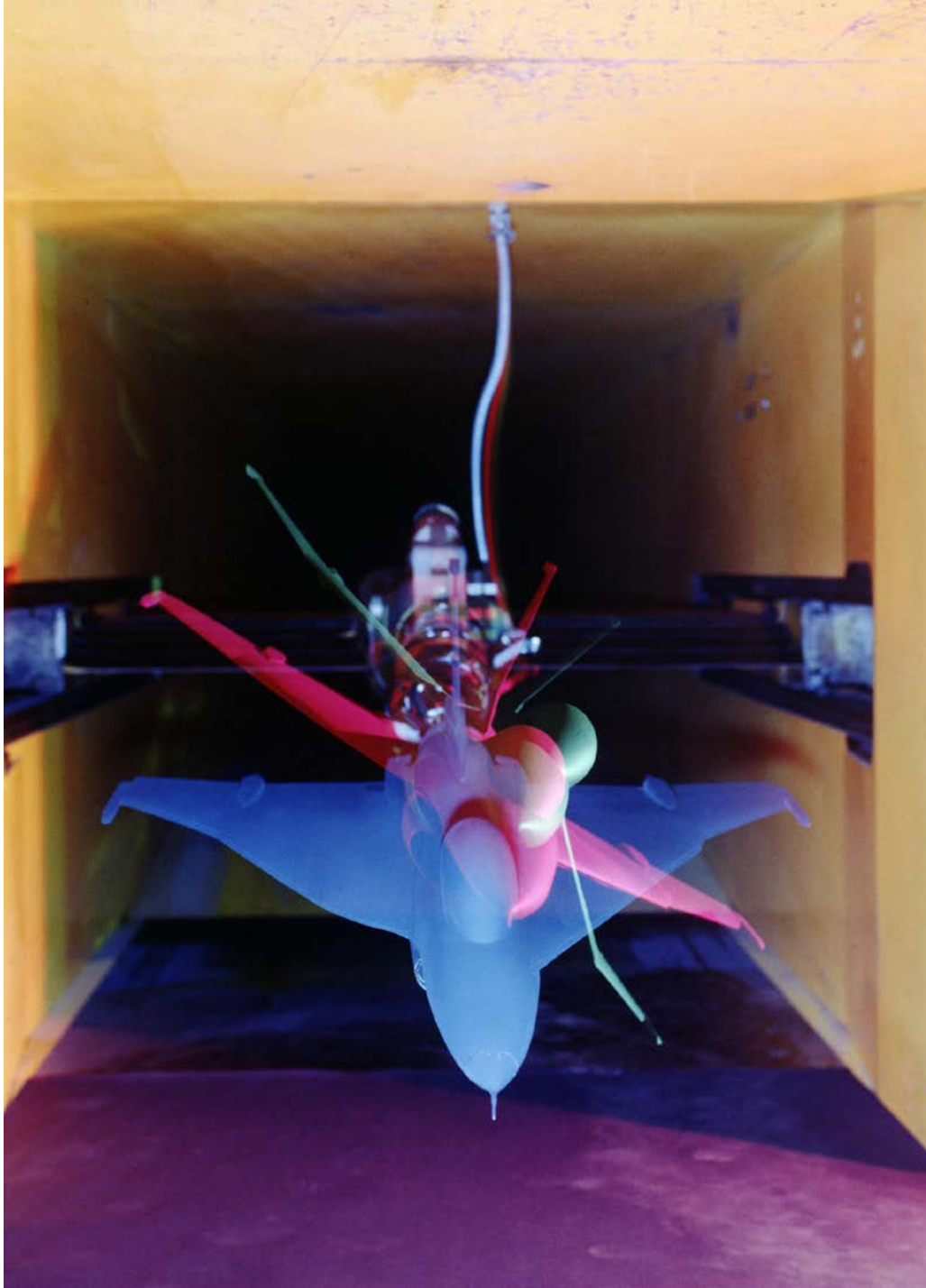

Figure 3-17. This is a multiple-exposure image of the F-16XL Supersonic Laminar Flow Control (SLFC) model in Langley's Unitary Plan Wind Tunnel taken in April 1994. This wind-tunnel test was conducted to verify design pressure distributions for the SLFC flight experiment (see the modified port wing) and to obtain simulator coefficients for stability and control investigations. (NASA-LaRC photo EL-1996-00141).

Late in 1992, discussions had taken place at Langley about the possibility of refurbishing and using a Russian Tu-144 supersonic jet as a flying laboratory and for supersonic flight research with the aircraft's manufacturer, Tupolev. NASA Headquarters and Tupolev had also discussed the idea informally at the Paris Air Show. In August 1994, Vice President Albert Gore and Russian Prime Minister Viktor Chernomyrdin signed an agreement to use the Tu-144 aircraft as a flying laboratory for flight research to develop enabling technologies as part of the HSR program.²⁰¹ Using a Tu-144LL that had been modified by its developer/builder (Tupolev ANTK), NASA, a team of U.S. aircraft and engine manufacturers, and Tupolev conducted six on-board experiments and two ground experiments. Their goal was to obtain data to develop technologies for an environmentally compatible and economically viable future supersonic transport (see table 3-30). In the first ground test, eight configurations were tested to determine the effect of aircraft inlet structures on the quality of the airflow entering the engine. In the second engine ground test, 22 transient configurations were tested to determine what happened to inlet and engine performance and stability of operation when supersonic shock waves rapidly changed position in the inlet.²⁰²

Between January 1997 and March 1998, the Tu-144LL completed 18 research flights involving six flight experiments (in aerodynamics, thermodynamics, structural and cabin noise, propulsion systems environment, aircraft handling qualities, and landing characteristics). Researchers compared the results from this supersonic aircraft with results from models in wind tunnels,

²⁰¹ "Fiscal Year 1996 Estimates, Office of Aeronautics and Space Technology," http://www.hq.nasa.gov/office/budget/fy96/sat_4.html (accessed June 19, 2006).

²⁰² "Aeronautics and Space Transportation Technology Enterprise FY 1999 OMB Budget Estimate," p. 18.

computer-aided techniques, and other flight tests.²⁰³ A shorter follow-up program consisting of seven flights began in September 1998 and ended in April 1999. All flights took place in Russia at Tupolev's facility near Moscow. Langley's Robert A. Rivers and Dryden's C. Gordon Fullerton became the first American pilots to fly the modified Tu-144LL during the 1998 experiments. Figure 3-18 shows the Tu-144LL Flying Laboratory in Russia.



Figure 3-18. The Russian Tu-144LL SST Flying Laboratory landing with drag chutes at the Zhukovsky Air Development Center near Moscow, Russia, in July 1997 (NASA photo no. EC97-44203-2, NASA/IBP).

In June 1997, a series of flight tests were performed with the NASA 737 research aircraft to determine how well pilots could adjust to an external vision system accompanied by side

²⁰³ *Aeronautics & Space Transportation Technology; Three Pillars for Success: Turning Goals Into Reality, Annual Progress Report 1997–1998*, pp. 49–50. Also Chambers, *Innovation in Flight Research*, p. 60.

windows. The view out the forward cockpit windows would be replaced by large sensor displays using video images, enhanced by computer-generated graphics.²⁰⁴ The system would guide pilots to an airport, warn them of other aircraft near their flight path, and provide additional visual aids for airport approaches. The goal was to develop an aircraft without the heavy and expensive “nose-droop” design of the Concorde, saving an estimated 20,000 pounds (9,072 kilograms) in gross weight. A longer fixed-nose design could reduce drag, which would result in additional fuel and weight savings. An external vision system could also provide safety and performance capabilities exceeding those of unaided human vision.²⁰⁵

Flight control was also an important concern. In December 1997, a real-time piloted simulation was developed at Langley to represent the expected flight and structural-dynamics behavior of a supersonic aircraft during key mission tasks. The purpose was to determine the requirements for a structural mode control system that would minimize cockpit vibration so that the pilot could perform required tasks. The test results would be used to develop advanced flight-control laws for future supersonic transports. An understanding of aeroelastic flying qualities and control criteria would also help guide the design of other future advanced, highly flexible, piloted aerospace vehicles.²⁰⁶

New high-temperature materials and structural concepts for various subcomponents in the TCA’s fuselage and wings were selected for fabrication and testing. Materials durability was a critical

²⁰⁴ “NASA’s High-Speed Research Program, Developing a Future Supersonic Passenger Jet,” NASA Facts Online, FS-1998-05-15-LaRC, May 1998, <http://oea.larc.nasa.gov/PAIS/HSR-General.html> (accessed July 24, 2006).

²⁰⁵ *Aeronautics & Space Transportation Technology; Three Pillars for Success: Turning Goals Into Reality, Annual Progress Report 1997–1998*, p. 49.

²⁰⁶ *Aeronautics & Space Transportation Technology: Three Pillars for Success, Annual Progress Report 1997–1998*, p. 51.

area. It was necessary to develop tests that could predict how well candidate materials would withstand the mechanical and environmental factors that contribute to long-term degradation of properties under conditions simulating high-speed flight because not all candidate materials could be subjected to adequate long-term tests. The HSCT was intended to have a lifetime of 60,000 flight hours. At speeds of Mach 2.4, the maximum operating temperature could reach 350°F (177°C). In 1995, after examining more than 200 possible materials, researchers at Langley decided that a new composite material—phenylethynyl terminated imide (PETI-5)—could meet the temperature and durability requirements of a future supersonic transport flying at speeds greater than 1,500 miles per hour (2,414 kilometers per hour), altitudes of 65,000 feet (19,812 meters), and surface temperatures as high as 350°F (177°C). In tests, two 40- by 80-inch (102- by 203-centimeter) panels made of the composite material were subjected to a force of more than 400,000 pounds (1,779 kilonewtons) before cracking occurred. The tested structure showed promise as the primary wing and fuselage material for a supersonic transport. However, the unacceptably high manufacturing cost was a major barrier to application of the technology. Adequate developmental testing was not accomplished during the lifetime of the HSR program. Nevertheless, its use for other applications was recognized, and the material received the NASA Commercial Invention of the Year award for 1998, and *Research and Development Magazine's* R&D 100 award.²⁰⁷

In early 1998, Langley researchers completed more than 15,000 hours of flight-profile tests on structural samples of new high-temperature materials that resembled PETI-5. Two polymeric matrix composites, called IM7/5260 and IM7/K3B, performed as expected without experiencing

²⁰⁷ *Aeronautics & Space Transportation Technology: Three Pillars for Success, Annual Progress Report 1997–1998*, pp. 47–48. Also Chambers, *Innovation in Flight Research*, pp. 57–58.

any degradation. Researchers were to continue testing the samples until more than 60,000 flight-profile hours were achieved, the equivalent of the expected 20-year lifespan of an airplane. The tests were designed to simulate the forces and temperatures an aircraft would experience during an entire flight, and the results had to demonstrate that the materials would perform as needed before they could be used to build a future commercial supersonic transport.²⁰⁸

To address future noise requirements, a new type of supersonic engine nozzle was developed and tested at Lewis Research Center. The Large-Scale Model 1 (LSM-1) test looked at nozzle design in a realistic engine environment. Earlier, the designs had been tested only on a small scale in wind tunnels without the severe operating conditions found behind a jet engine core. The LSM-1 test provided the first opportunity to evaluate new HSR-developed materials for the nozzle. A noise-quieting liner panel made from a ceramic matrix composite material survived testing for 22 hours with no signs of degradation.²⁰⁹

HSR activities also focused on the effects of radiation exposure on the aircrew and passengers of an HSCT. To refine and validate the data and models associated with the high-altitude radiation environment, NASA and the DOE Environmental Measurements Laboratory created the Atmospheric Ionizing Radiation (AIR) project under the auspices of the HSR program. For the AIR project, international investigators were solicited to contribute instruments to fly on an ER-2 aircraft at altitudes similar to those proposed for the HSCT—between 52,000 and 70,000 feet (15,850–21,336 meters). The flight series took place at solar minimum (radiation maximum)

²⁰⁸ *Aeronautics & Space Transportation Technology: Three Pillars for Success, Annual Progress Report 1997–1998*, p. 48.

²⁰⁹ *Ibid.*, p. 52.

with northern, southern, and east–west flights.²¹⁰ Although exposure levels are higher at HSCT cruise altitudes compared to current subsonic flight altitudes, passengers would actually receive less radiation exposure on HSCT flights because they would spend less time in the air due to the higher aircraft speed.²¹¹ Further, researchers proposed to minimize long-term radiation exposure for crew members who might work many hours at cruise altitudes up to 68,000 feet (20,726 meters) by rotating the crew schedules.

During the early 1990s, industry and NASA together received strong support from a Congress that was concerned about the level of the country’s investment in advanced technology. However, the 1994 elections produced a Congress that was more concerned with deficit reduction than “national competitiveness.” The Republican-controlled Congress demanded a balanced budget amendment and a balanced federal budget within seven years, with tax cuts and increased military spending at the same time.²¹² NASA, as the recipient of a portion of federal “discretionary” funds, took a large cut in FY 1994 below its FY 1993 budget.²¹³ Also, by 1998, the corporate alliance among Boeing, General Electric Aircraft Engines, Pratt & Whitney, and McDonnell-Douglas was beginning to break down. The number of aerospace companies had declined through a series of mergers, and the shrinking defense budget produced a decline in aerospace research and development spending for defense-related aeronautics that was offset only slightly by the increase in NASA’s aeronautics spending.²¹⁴

²¹⁰ Chambers, *Innovation in Flight Research*, p. 61. Also “NASA’s High-Speed Research Program; Research—the Environmental Effects of a Supersonic Passenger Jet,” FS-1998-03-33-LaRC, March 1998, <http://www.nasa.gov/centers/langley/news/factsheets/HSR-Environ.html> (accessed May 25, 2006).

²¹¹ “NASA’s High-Speed Research Program, Developing a Future Supersonic Passenger Jet,” NASA Facts Online, FS-1998-05-15-LaRC, May 1998, <http://oea.larc.nasa.gov/PAIS/HSR-General.html> (accessed July 24, 2006).

²¹² Conway, pp. 286–287.

²¹³ Discretionary spending applies to programs whose funding must be provided each year in appropriations legislation; their spending is thus subject to the annual “discretion” of Congress.

²¹⁴ Conway, pp. 287–288.

In July 1997, NASA had proposed an extension to the HSR program, called Phase IIA, to focus on answering the remaining technological questions related to whether U.S. industry would be able to build a viable, economical, and environmentally sound HSCT. Planned to begin in FY 1999, Phase IIA was to further mitigate risk in the areas of propulsion and airframe materials and structures. Its objective was to deliver well-defined products, including propulsion component rig tests, fabrication and ground tests of a full-scale engine and exhaust nozzle, and fabrication and durability tests of major fuselage and wingbox subassemblies using optimized preproduction materials and structures processes. An additional \$836.5 million was to fund the work. In July 1998, funding was reduced to \$500 million, and the program content was scaled down partly in response to known changes in Boeing's position concerning the manufacture of a high-speed aircraft.²¹⁵

By this time, Boeing had concluded that key HSR technologies had not advanced far enough, especially in the areas of propulsion, noise, and fuel-tank sealants. These concerns, along with a long airline recession followed immediately by an unexpectedly large boom, production problems with its existing line of subsonic transports, major commitments to its new B777 aircraft, and other considerations, led the company to reexamine its participation in the program. It decided to reduce its commitment to the program and scale back its investments.²¹⁶ Market analyses and technology requirement assessments indicated that a commercial HSCT could not reasonably be introduced before 2020. Industry and NASA also questioned whether the technologies being pursued would adequately address environmental standards and other

²¹⁵ "Aeronautics and Space Transportation Technology Enterprise FY 1999 OMB Budget Estimate," p. 18. Also "Appendix A—Changes of Program Commitment Agreement," High-Speed Research (HSR) Program, May 10, 1999, p. A-2.

²¹⁶ Conway, p. 288. Also "Office of Aero-Space Technology Fiscal Year 2000 Estimates," p. 4.1-29.

challenges in 2020. In February 1999, after Boeing dramatically reduced its support for the project, NASA announced it would terminate the HSR program at the end of FY 1999. The Agency redirected \$600 million from the HSR program to the International Space Station budget.²¹⁷

High-Performance and Experimental Aircraft

Uninhabited Aerial Vehicles

The term “unmanned [or uninhabited] aerial vehicle” (UAV) came into general use in the early 1990s to describe robotic aircraft, generally replacing the term “remotely piloted vehicles.”²¹⁸

The DOD Dictionary defines a UAV as:

A powered, aerial vehicle that does not carry a human operator, uses aerodynamic forces to provide vehicle lift, can fly autonomously or be piloted remotely, can be expendable or recoverable, and can carry a lethal or nonlethal payload. Ballistic or semiballistic vehicles, cruise missiles, and artillery projectiles are not considered unmanned aerial vehicles.

A series of remotely piloted vehicles developed by NASA and industry flew out of Dryden Flight Research Center in the mid to late 1990s.

Environmental Research Aircraft and Sensor Technology (ERAST) Program

NASA’s ERAST program aimed to develop aeronautical technologies for a new generation of remotely piloted and autonomous aircraft for a variety of upper-atmospheric science missions

²¹⁷ Chambers, *Innovation in Flight Research*, pp. 61–62.

²¹⁸ Laurence R. Newcome, *Unmanned Aviation; A Brief History of Unmanned Aerial Vehicles*, (Reston, VA: American Institute of Aeronautics and Astronautics, Inc., 2004), p. 1. Also “DOD Dictionary of Military Terms,” <http://www.dtic.mil/doctrine/jel/doddict/> (accessed August 5, 2006).

and commercial applications. Its goals were to foster new materials and propulsion, control, instrumentation, and sensor technologies that would enable the development of a variety of slow-flying, high-altitude aircraft to perform long-duration science missions in the upper stratosphere. The missions, flown either autonomously or remotely by a pilot in a ground control station, could include Earth-sciences studies, storm tracking, atmospheric sampling, and spectral imaging for agricultural and natural-resource monitoring. Such “atmospheric satellite” aircraft would also have potential for commercial use, serving as relay platforms for telecommunications systems.

Management and operations were led by Dryden Flight Research Center. Lewis and Langley contributed to the ERAST program in the areas of propulsion, energy-storage systems, structures, and systems analysis. NASA also worked closely with the FAA to develop operational plans to ensure that the remotely operated aircraft could be safely flown in national airspace.

NASA began the program in FY 1994 to develop UAV technology and sensors that could be carried by these aircraft. Four concepts (or testbeds) were considered for ERAST: (1) Perseus A and B, (2) Pathfinder, (3) GNAT 750, and (4) Raptor Demonstrator (D-2). Apex was also to have been part of the program, but was canceled before the aircraft was assembled and flown. In 1999, the Proteus aircraft was adopted into the ERAST program.

Perseus A and B. Designed and built by Aurora Flight Sciences Corporation, Perseus was a propulsion/performance testbed. The Perseus A and B models were identical pusher-prop designs except for the landing gear (the A had tandem fuselage wheels, while the B had tricycle gear).

Perseus was initially developed as part of NASA's Small High-Altitude Science Aircraft (SHASA) program, which later evolved into the ERAST project. The Perseus proof-of-concept aircraft first flew in November 1991 and made three low-altitude flights within a month to validate the Perseus aerodynamic model and flight-control systems.²¹⁹

Two Perseus A four-cylinder aircraft were built and made 21 flights in 1993–1994. Perseus A incorporated a closed-cycle combustion system that mixed oxygen carried aboard the aircraft with engine exhaust to compensate for the thin air at high altitudes. It was towed into the air by a ground vehicle and its engine started after it became airborne. Prior to landing, the engine was stopped and the propeller was locked in the horizontal position. Perseus A then glided to a landing on its bicycle-type landing gear. One Perseus A aircraft reached over 50,000 feet (15,240 meters) in altitude on its third test flight. Although one Perseus A aircraft was destroyed in a crash after a vertical gyroscope failed in flight, the other aircraft completed its test program. See table 3-31 for Perseus A characteristics. Figure 3-19 shows the Perseus A aircraft.

²¹⁹ "Perseus B," Fact Sheet, <http://www.nasa.gov/centers/dryden/news/FactSheets/FS-059-DFRC.html> (accessed June 8, 2006).



Figure 3-19. The Perseus A, a remotely-piloted, high-altitude research aircraft, is seen here framed against the moon and sky during a research mission at the Dryden Flight Research Center, Edwards, California, in August 1994 (NASA-DFRC photo EC94-42742-7).

Perseus B was intended to serve as a propulsion and performance testbed for advanced high-altitude, remotely piloted aircraft. It also was designed to be a platform aircraft for actual science missions, carrying atmospheric sampling, weather monitoring, imaging, and telecommunications relay equipment in a payload bay in the forward fuselage. The objectives of the aircraft's flight tests were to reach and maintain horizontal flight above 60,000 feet (18,288 meters) and demonstrate the capability to fly missions lasting from 8 to 24 hours depending on payload and altitude requirements. The triple-turbocharged engine incorporated a closed-cycle combustion system that mixed oxygen carried aboard the aircraft with engine exhaust to compensate for the thin air at high design cruising altitude. With turbocharging, the four-cylinder engine was flat-

rated at 80 horsepower from sea level to 60,000 feet (18,288 meters). First flown on October 7, 1994, Perseus B flew twice more in early 1996 before being damaged in a hard landing on the dry lakebed after a propeller shaft failure. It was modified with a longer, stronger wing extending the original 58.7-foot (18-meter) wingspan to 71.5 feet (21.8 meters) and met Federal Aviation Regulations (FAR) Part 23 load requirements. A new series of four developmental flight tests began on April 30, 1998 at Dryden. Perseus B achieved a record altitude of 60,280 feet (18,373 meters) on its fourth flight on June 27, 1998, establishing an unofficial altitude record for a single-engine, propeller-driven, remotely piloted aircraft.

Modifications after the 1998 flight series included the addition of external fuel pods on the wing that more than doubled the fuel capacity to 100 gallons (378.5 liters). Engine power increased by more than 10 percent after a boost in the turbocharger output, becoming flat-rated at 105 horsepower to 60,000 feet (18,288 meters). Fuel consumption was reduced by means of fuel-control modifications and a leaner fuel-air mixture that did not compromise power.

Improvements in the aircraft's avionics suite included the installation of a second GPS unit, a ring laser gyroscope to replace a mechanical unit, and a longer-life emergency battery. The aircraft's rudder was modified by splitting it in two and installing an additional servo motor. Combined with a split elevator and independent ailerons, this gave the primary flight-control system full redundancy for flight safety. The flight-control software was also modified to incorporate fault-tolerant control capability, giving the system automatic detection and compensation for any flight sensor or actuator failure. The aircraft's air data instrumentation system was supplemented with the installation of a second pitot tube. The new unit was a heated five-hole probe to ensure accurate speed, pitch, and AoA measurements when the aircraft was at

high altitudes. Instrumentation that had been installed on the aircraft for initial development flights was removed or incorporated into the flight data system to free up payload space for future mission use. Standard aircraft running lights were installed so that the aircraft could be safely flown at night.²²⁰ Table 3-32 lists Perseus B characteristics.

Pathfinder.²²¹ Pathfinder was a lightweight, solar-powered, remotely piloted flying-wing aircraft that demonstrated the technology of applying solar power for long-duration, high-altitude flight. Solar arrays covering most of the upper wing surface powered the aircraft's electric motors, avionics, communications, and other electronic systems. Pathfinder's backup battery system provided power for 2–5 hours to allow limited-duration flight after dark.

Pathfinder flew at an airspeed of 15 to 25 miles (24.1 to 40.2 kilometers) per hour. Although pitch control was maintained by the use of tiny elevons on the trailing edge of the wing, turns and yaw control were accomplished by slowing down or speeding up the motors on the outboard sections of the wing.

Pathfinder was designed and fabricated by AeroVironment as a high-altitude, long-endurance aircraft for surveillance purposes for a classified government program in the early 1980s. Known as the HALSOL (for High-Altitude SOLar) aircraft, its eight electric motors—later reduced to six—were first powered by batteries. When that project was canceled, the aircraft was placed in storage for 10 years. In 1993, the aircraft was brought back to flight status by the Ballistic

²²⁰ "Perseus B," Fact Sheet, <http://www.nasa.gov/centers/dryden/news/FactSheets/FS-059-DFRC.html> (accessed June 8, 2006).

²²¹ "Pathfinder Solar-Powered Aircraft," Fact Sheet, <http://www.nasa.gov/centers/dryden/news/FactSheets/FS-034-DFRC.html> (accessed June 8, 2006). Also "Past Project: ERAST – Pathfinder/Pathfinder Plus," <http://www.nasa.gov/centers/dryden/history/pastprojects/Erast/pathfinder.html> (accessed June 8, 2006).

Missile Defense Organization (BMDO). With the addition of small solar arrays, five low-altitude checkout flights were flown under the BMDO program at Dryden in the fall of 1993 and early 1994 with a combination of solar and battery power.

In late 1994, the aircraft was transferred to NASA, which was to develop science platform aircraft technology as part of the newly established ERAST program. After researchers conducted further flight tests at Dryden that year, additional solar cells were added, eventually covering most of the upper surface of the wing. Pathfinder was then brought back for another series of development flights at Dryden in 1995. On September 11, 1995, the aircraft reached an altitude of 50,500 feet (15,392 meters) during a 12-hour flight, setting a new altitude record for solar-powered aircraft. The National Aeronautic Association presented the NASA-industry team with an award for one of the “10 Most Memorable Record Flights” of 1995. Later that fall, on October 21, 1995, Pathfinder was severely damaged in a hangar mishap. After repairs, additional upgrades, and a November 1996 checkout flight at Dryden, it was transported to the U.S. Navy’s Pacific Missile Range Facility (PMRF) at Barking Sands, Kaua’i, Hawai’i, in April 1997.

Pathfinder flew seven high-altitude flights from PMRF. On July 7, 1997, it set a new altitude record for propeller-driven as well as solar-powered aircraft, reaching 71,530 feet (21,802 kilometers). The flights also tested two new scientific instruments: a high-spectral-resolution Digital Array Scanned Interferometer (DASI) and a high-spatial-resolution Airborne Real-Time Imaging System (ARTIS), both developed at Ames. Figure 3-20 shows a flight in August 1997.



Figure 3-20. Pathfinder, NASA's solar-powered, remotely piloted aircraft, is shown while conducting a series of science flights in August 1997 in which it collected imagery of forest and coastal zone ecosystems on Kaua'i, Hawaii (NASA-DFRC photo EC97-44287-2).

During 1998, Pathfinder was modified into the longer-winged Pathfinder-Plus. Essentially a transitional vehicle between the Pathfinder and the follow-on Centurion/Helios solar wings, the Pathfinder-Plus was a hybrid of the technology that was used on Pathfinder and developed for Pathfinder's successor, the Centurion/Helios prototype. The most noticeable change was the installation of a new 44-foot (13.4-meter) center wing section incorporating a high-altitude airfoil designed for Centurion/Helios. The new section was twice as long as the original Pathfinder center section and increased the overall wingspan of the craft from 98.4 feet (30

meters) to 121 feet (36.9 meters). The new center section was topped by more efficient silicon solar cells developed by SunPower Corporation, Sunnyvale, California, that could convert almost 19 percent of the solar energy they received to useful electrical energy to power the craft's motors, avionics, and communication systems. The older solar arrays covering most of the surface of the middle and outer wing panels from the original Pathfinder had only about 14 percent efficiency. The maximum potential power was boosted from about 7,500 watts on Pathfinder to about 12,500 watts on Pathfinder-Plus.

In addition, the Pathfinder-Plus was powered by eight electric motors—two more than the previous version of Pathfinder used. Designed for the Centurion/Helios prototype, the motors were slightly more efficient than the original Pathfinder motors. The Pathfinder-Plus also validated a new flight-control system for the Centurion/Helios prototype.

On August 6, 1998, the Pathfinder-Plus was flown to a record altitude for propeller-driven aircraft of 80,201 feet (20,445 meters) on the third of a series of developmental test flights from PMRF on Kaua'i. The goal of the flights was to validate new solar, aerodynamic, propulsion, and systems technologies developed for the Centurion/Helios prototype that was designed to reach and sustain altitudes in the 100,000-foot (30,480-meter) range.

The major science activities of the Pathfinder missions included assessing forest nutrient status, forest regrowth after damage caused by Hurricane Iniki in 1992, sediment/algal concentrations in coastal waters, and coral reef health. Science activities were coordinated by Ames Research Center and included researchers at the University of Hawaii and the University of California.

These flights were conducted at altitudes between 22,000 and 49,000 feet (6,705 and 14,935 meters) in 1997.²²² Table 3-33 lists Pathfinder and Pathfinder-Plus characteristics.

GNAT 750. Developed as a multiday-duration UAV by General Automics, El Mirage, California, this pusher-prop design carried an array of sensors that “read” the amount of solar radiation streaming through the atmosphere. The aircraft was related to a family of long-endurance tactical surveillance and support system aircraft that had been flying since 1989. The Predator was a growth version of the GNAT 750 and was used extensively by DOD on a variety of surveillance missions.²²³

The Altus II and its sister ship, the Altus I, were civil version of the Predator surveillance drone built by General Atomic Aeronautical Systems Inc. They were designed for high-altitude, long-duration scientific sampling missions and were powered by turbocharged piston engines. Although similar in appearance to the Predator, the Altus had a slightly longer wingspan and was designed to carry atmospheric sampling and other instruments for civilian scientific research missions in place of the military reconnaissance equipment carried by the Predators.

The Altus aircraft were distinguished by their long, narrow, high-aspect-ratio wing; slender fuselage; rear-mounted engine and propeller; and inverted-V horizontal tail. They could carry up to 330 pounds (150 kilograms) of sensors and other scientific instruments in a nose-mounted payload compartment, a location designed to allow air being sampled by the sensors to be

²²² “Pathfinder Solar-Powered Aircraft,” Fact Sheet, <http://www.nasa.gov/centers/dryden/news/FactSheets/FS-034-DFRC.html> (accessed June 8, 2006). Also “Past Project: ERAST—Pathfinder/Pathfinder Plus,” <http://www.nasa.gov/centers/dryden/history/pastprojects/Erast/pathfinder.html> (accessed June 8, 2006).

²²³ “General Atomic GNAT-750 Lofty View,” Federation of American Scientists, FAS Intelligence Resource Program, <http://www.fas.org/irp/program/collect/gnat-750.htm> (accessed July 11, 2006).

undisturbed by heat or pollutants from engine exhaust. They had tricycle-type retractable landing gear. A four-cylinder Rotax 912 gasoline engine provided power, and a turbocharger built by Thermo-Mechanical Systems., Inc., Canoga Park, California, provided additional airflow.²²⁴

The Altus II, built for NASA's ERAST program and the first of the two Altus aircraft to be completed, made its first flight on 1 May 1996. With its engine originally augmented by a single-stage turbocharger, the Altus II reached an altitude of 37,000 feet (11,278 meters) during its first series of development flights at Dryden in August 1996, and flew at that altitude for more than 2 hours on September 5, 1996. In October of that year, the Altus II was flown in an Atmospheric Radiation Measurement study for the DOE's Sandia National Laboratory in Oklahoma. During that series of flights, the Altus II set a single-flight endurance record for remotely operated aircraft of more than 26 hours.

In the spring of 1998, the Altus II underwent a series of upgrades. It received a larger fuel tank and additional intercooling capacity, and was modified to a two-stage turbocharger designed to enable the craft to fly at altitudes in the 65,000-foot (19,812-meter) range. On March 5, 1999, the aircraft flew above 55,000 feet (16,764 meters) for more than 3 hours.²²⁵ It also flew at 50,000 feet (15,240 meters) altitude for 8 hours.²²⁶ A pilot in a control station on the ground flew the craft by radio signals, using visual cues from a video camera in the nose of the Altus and information from the craft's air data system.²²⁷ Later that spring, the Altus II flew another series

²²⁴ "Altus II," <http://www.nasa.gov/centers/dryden/news/FactSheets/FS-058-DFRC.html> (accessed July 11, 2006).

²²⁵ "Altus II," <http://www.nasa.gov/centers/dryden/news/FactSheets/FS-058-DFRC.html> (accessed July 11, 2006).

²²⁶ "Past Projects—ERAST: Altus," <http://www.nasa.gov/centers/dryden/history/pastprojects/Erast/altus.html> (accessed July 11, 2006).

²²⁷ "Altus Photo Gallery Contact Sheet: Project Description," <http://www.dfrc.nasa.gov/gallery/Photo/Altus/HTML/index.html> (accessed July 11, 2006).

of Atmospheric Radiation Measurement missions conducted by Sandia National Laboratories for the DOE. Hard-to-measure properties of high-level cirrus clouds that may affect global warming were recorded using specially designed instruments while the Altus flew at 50,000 feet (15,240 meters) altitude off Kaua'i. The aircraft last flew in July 2002.²²⁸ Figure 3-21 shows the Altus II in flight in 1998.



Figure 3-21. The San Gabriel range is visible as the remotely piloted Altus II flies over Southern California's high desert, 29 June 1998 (NASA photo: EC98-44684, General Atomics).

²²⁸ Kimberly Kasitz, public relations and marketing manager, UAV (General Atomics Aeronautical Systems, Inc.), e-mail to author, August 1, 2006.

The Altus I was built for the Naval Postgraduate School in Monterey, California, and completed in 1997. Incorporating a single-stage turbocharger, it flew a series of development flights at Dryden the summer of 1996. Those test flights culminated with the craft reaching an altitude of 43,500 feet (13,258.8 meters) while carrying a simulated 300-pound (136-kilogram) payload, a record for an uncrewed aircraft powered by a piston engine augmented with a single-stage turbocharger.²²⁹ Figure 3-22 shows the Altus I in flight. Table 3-34 lists Altus characteristics.



Figure 3-22. Altus I aircraft in flight, retarding its landing gear after takeoff from Rogers Dry Lake adjacent to Dryden Flight Research Center, Edwards, California, 1 August 1997 (NASA photo EC 97-44175-14, Carla Thomas).

²²⁹ “Altus Photo Gallery Contact Sheet: Project Description,” <http://www.dfrc.nasa.gov/gallery/Photo/Altus/HTML/index.html> (accessed July 11, 2006).

Beginning in 1999, General Atomics developed an enlarged version of its Predator reconnaissance aircraft, the Predator B, including an extended-wingspan Altair version for NASA, to meet NASA's requirements for remotely operated, uninhabited aircraft to perform high-altitude Earth-science missions.²³⁰

Raptor D-2 Demonstrator. The Raptor D-2 aircraft was designed to test technologies that could result in long-duration (12–72 hours), high-altitude vehicles. Key technology development areas included lightweight structures, science payload integration, engine development, and flight-control systems. Developed for the Ballistic Missile Defense Organization by Scaled Composites, Mojave, California, it featured a puller propeller that required science instruments to be mounted in wing pods to pull in undisturbed air.²³¹ Flight tests began August 23, 1994. In late 1996, NASA demonstrated over-the-horizon communication capabilities with the D-2 using the Tracking and Data Relay Satellite System to command and control the aircraft.²³² After a break to install a new, triply redundant flight-control system, the aircraft returned to flight status on August 7, 1998, for a flight to check out the system that would allow remotely piloted high-altitude missions. The D-2 was unique among the testbed aircraft in the ERAST program in that it could be flown either by an on-board pilot or by remote control.²³³ Figure 3-23 shows the D-2 in flight. Table 3-35 lists Raptor D-2 characteristics.

²³⁰ “Altair/Predator B: An Earth Science Aircraft for the 21st Century,” <http://www.nasa.gov/centers/dryden/news/FactSheets/FS-073-DFRC.html> (accessed June 8, 2006).

²³¹ “Dryden Is Lead Center in ERAST Role, NASA Dryden X-Press, October 1994,” <http://www.dfrc.nasa.gov/Newsroom/X-Press/1994/xp-94-10.html> (accessed June 8, 2006).

²³² “Past Projects—ERAST, D-2 Demonstrator,” <http://www.nasa.gov/centers/dryden/history/pastprojects/Erast/d2.html> (accessed June 8, 2006).

²³³ “D-2 Resumes Flight Tests,” Research Roundup, Dryden X-Press, September 18, 1998, 8, <http://www.dfrc.nasa.gov/Newsroom/X-Press/1998/sep18-TX/page8-TX.html> (accessed June 8, 2006).



Figure 3-23. Raptor D-2 Demonstrator in flight in 1996 (NASA-DFRC photo EC97-44102-2).

X-Planes

NASA flew three experimental aircraft (called X-planes) during the decade from 1989 to 1998.²³⁴

X-29. The X-29 has been used for high-performance flight research since 1984, when the first of two X-29 aircraft made its inaugural flight (Phase 1). The second X-29 first flew on May 23, 1989 (Phase 2). There was also a follow-on vortex-control phase (VFC) using the second

²³⁴ Development of the X-33 and X-34 is discussed in the section on reusable launch vehicles later in this chapter.

aircraft. Grumman Aircraft Corporation built the two X-29s under a contract with the Defense Advanced Research Projects Agency (DARPA).²³⁵

Phase 1, using the No. 1 X-29, demonstrated that the forward sweep of the X-29 wings kept the wing tips unstalled at the moderate AoAs flown in that phase (a maximum of 21 degrees). Phase 1 also demonstrated that the aeroelastic tailored wing prevented structural divergence of the wing within the flight envelope, and that the control laws and control-surface effectiveness were adequate to provide artificial stability for an otherwise unstable aircraft. Phase 1 further demonstrated that the X-29 configuration could fly safely and reliably, even in tight turns. The No. 1 aircraft flew 242 flights through December 1988—a record for any X-series plane at Dryden.²³⁶

Tests on the No. 2 X-29 investigated the aircraft's high AoA (or alpha) characteristics and the military utility of its forward swept-wing/canard configuration.²³⁷ In Phase 2, flying at up to 67 degrees AoA, the aircraft demonstrated much better control and maneuvering qualities than computational methods and simulation models had predicted. During 120 research flights in this phase, NASA, U.S. Air Force, and Grumman project pilots reported that the X-29 aircraft had excellent control response to an AoA of 45 degrees and still had limited controllability at a 67-degree AoA. This controllability at high AoAs could be attributed to the aircraft's distinctive

²³⁵ *NASA Aeronautics, Research and Technology Program Highlights*, NP 159, p. 35. DARPA was the research arm of DOD. In March 1993, it reverted to a previous designation: ARPA (Advanced Research Projects Agency). In February 1996, it reverted to DARPA in accordance with Public Law 104-106, under Title IX of the Fiscal Year 1996 Defense Authorization Act.

²³⁶ "X-29," Fact Sheet, Dryden Flight Research Center, <http://www.nasa.gov/centers/dryden/news/FactSheets/FS-008-DFRC.html> (accessed August 3, 2006).

²³⁷ Angle of attack (AoA), or alpha, is the term used to describe an aircraft's angle relative to its flight path. During maneuvers, pilots often fly at extreme AoAs, with the nose pitched up while the aircraft continues in its original direction. This can lead to loss of control and result in the loss of the aircraft, pilot, or both.

forward swept-wing/canard design. The NASA/Air Force-designed high-gain flight-control laws also contributed to its good flying qualities.²³⁸

During the follow-on VFC phase, the Air Force studied the use of VFC as a means of obtaining increased aircraft control at high AoAs when normal flight-control systems would be ineffective. The No. 2 X-29 was modified with the installation of two high-pressure nitrogen tanks and control valves with two small nozzle jets on the forward upper portion of the nose. The purpose of the modifications was to inject air into the vortices flowing off the nose of the aircraft at high AoAs. Wind tunnel tests at Grumman and the Air Force's Wright Laboratory showed that injecting air into the vortices would change the direction of vortex flow and create corresponding forces on the nose of the aircraft to change or control the nose heading.²³⁹ Figure 3-24 shows vortex flow demonstrated by smoke over the forebody of the aircraft.

²³⁸ "X-29 #049—First Flight," Project Description, <http://www.dfrc.nasa.gov/Gallery/Photo/X-29/HTML/EC89-0127-004.html> (accessed August 3, 2006).

²³⁹ "X-29," Fact Sheet, Dryden Flight Research Center, <http://www.nasa.gov/centers/dryden/news/FactSheets/FS-008-DFRC.html> (accessed August 3, 2006).



Figure 3-24. This photo shows the X-29 during a September 1991 research flight. Smoke generators in the nose of the aircraft were used to help researchers see the behavior of the air flowing over the aircraft. The smoke here is demonstrating forebody vortex flow (NASA photo EC91-491-6).

During 60 flights from May to August, the X-29 successfully demonstrated VFC. It was more effective than expected in generating yaw forces, especially at higher AoAs, where the rudder was less effective. VFC was less effective in providing control when sideslip (relative wind pushing on the side of the aircraft) was present, and it did little to decrease rocking oscillation of

the aircraft.²⁴⁰ Overall, VFC, like the forward swept wings, showed promise for the future of aircraft design.

The X-29 program demonstrated several new technologies as well as new uses of proven technologies. These included:

- Aeroelastic tailoring to control structural divergence
- Use of a relatively large, close-coupled canard for longitudinal control
- Control of an aircraft with extreme instability while still providing good handling qualities
- Use of three-surface longitudinal control
- Use of a double-hinged trailing-edge flaperon at supersonic speeds
- Control effectiveness at high AoA; vortex control
- Military utility of the overall design

See table 3-36 for X-29 characteristics.

X-31 Enhanced Maneuverability Demonstrator. Two X-31 Enhanced Fighter Maneuverability (EFM) demonstrators flew at Dryden Flight Research Center and at Palmdale, California, to obtain data potentially applicable to the design of highly maneuverable next-generation fighters. An international test organization of about 110 people managed by DARPA (redesignated ARPA from March 1993 to 1996) conducted the flight tests. NASA was responsible for flight-test operations, aircraft maintenance, and research engineering after the

²⁴⁰ “X-29 #049—First Flight,” Project Description, <http://www.dfrc.nasa.gov/Gallery/Photo/X-29/HTML/EC89-0127-004.html> (accessed August 3, 2006).

project moved to Dryden from Palmdale. As the research flight program matured, the test organization decreased in size to approximately 60 persons.

The X-31 research program produced technical data at high AoAs, or alphas. This information improved engineers and aircraft designers' understanding of aerodynamics, the effectiveness of flight controls and thrust vectoring, and airflow phenomena at high AoAs. It may also lead to design methods that provide better maneuverability in future high-performance aircraft, making such aircraft safer to fly and giving them a significant advantage over most conventional fighters.²⁴¹ The program demonstrated the value of thrust vectoring coupled with advanced flight-control systems to achieve controlled flight during close-in air combat at very high alphas. The aircraft was designed to break the "stall barrier," allowing it to fly at an AoA that would typically cause an aircraft to stall with a complete loss of control.²⁴²

Three thrust-vectoring paddles mounted on the X-31's airframe adjacent to the engine nozzle directed the exhaust flow to improve control in pitch and yaw. Made of carbon-carbon, an advanced carbon fiber-reinforced composite, the paddles could sustain temperatures of up to 1,500°C (2,732°F) for extended periods. In addition, the X-31s were configured with movable forward canards and eventually with fixed aft strakes. The canards were small wing-like structures set on a line between the nose and the leading edge of the wing. The strakes were set on the same line between the trailing edge of the wing and the engine exhaust. Both supplied additional pitch control in tight maneuvering situations.

²⁴¹ "Thrust vectoring" is directing engine exhaust flow using thrust-vectoring paddles.

²⁴² Dennis R. Jenkins, Tony Landis, and Jay Miller, *American X-Vehicles: An Inventory—X-1 to X-50*, Monographs in Aerospace History No. 31 (Washington, DC: NASA SP-2003-4531, 2003), p. 39.

The X-31 operated with a digital fly-by-wire flight-control system. The system included four digital flight-control computers with no analog or mechanical backup. Three synchronous main computers drove the flight-control surfaces. The fourth computer served as a “tie-breaker” in case the three main computers produced conflicting commands.²⁴³

The X-31 program was divided into three phases. Phase 1 was the conceptual design phase during which program personnel outlined the payoff expected from the application of EFM concepts in future air battles and defined the technical requirements for a demonstrator aircraft. In Phase 2 researchers carried out the preliminary design of the demonstrator and defined the manufacturing approach. Three governmental reviews of the proposed design took place during this phase. Technical experts from the U.S. Navy, the German Federal Ministry of Defense, and NASA carefully examined all aspects of the design.

Phase 3 involved the initiation and completion of the detailed design and fabrication of two aircraft, which were assembled at the Rockwell International (now Boeing) facility at Air Force Plant 42, Palmdale, California. This phase required that both aircraft fly a limited flight-test program. The first aircraft was rolled out on March 1, 1990 and made its first flight on October 11, 1990. The aircraft reached a speed of 340 miles per hour (547 kilometers per hour) and an altitude of 10,000 feet (3,048 meters) during its initial 38-minute flight.²⁴⁴

²⁴³ “Past Projects, X-31 Enhanced Fighter Maneuverability,” <http://www.nasa.gov/centers/dryden/history/pastprojects/X31/index.html> (accessed August 3, 2006).

²⁴⁴ “X-31 Enhanced Fighter Maneuverability Demonstrator,” Fact Sheet, <http://www.nasa.gov/centers/dryden/news/FactSheets/FS-009-DFRC.html> (accessed August 3, 2006).

The second aircraft made its first flight on January 19, 1991. Although both aircraft had identical external dimensions, the No. 2 X-31 experienced stronger yaw asymmetries than No. 1, earning it the nickname the “evil twin.” The team tested aircraft No. 2 with varying lengths of extended nose strakes and found that it could get the two aircraft to fly identically with 8.5 inches (21.6 centimeters) of strake length on the second X-31.

During the program’s initial phase of operations at the Rockwell facility, pilots flew the aircraft on 108 test missions. They achieved thrust vectoring in flight and expanded the post-stall envelope to 40 degrees AoA before flight operations were moved to Dryden in February 1992 at the request of DARPA.

At Dryden, an international team of pilots and engineers from the International Test Organization (ITO) expanded the aircraft’s flight envelope, including military utility evaluations that pitted the X-31 against comparable but non-thrust-vectoring aircraft to evaluate the maneuverability of the X-31 in simulated air combat. The ITO included participants from NASA, the U.S. Navy, the U.S. Air Force, Rockwell Aerospace, the Federal Republic of Germany, and Daimler-Benz (formerly Messerschmitt-Bolkow-Blohm and Deutsche Aerospace).

The first flight from Dryden under the ITO took place in April 1992. The actual flights required that the research team modify the control laws that had been based on wind tunnel predictions. Previous AoA research and new wind tunnel tests with an X-31 model also led the team to add strakes to the nose that were 0.6 inch (1.5 centimeters) wide by 20 inches (50.8 centimeters) long, blunting the nose tip slightly and improving the aircraft’s aerodynamics.

The No. 2 X-31 achieved controlled flight at 70 degrees AoA at Dryden on November 6, 1992. On the same day, it performed a controlled roll around the aircraft's velocity vector, also at 70 degrees. On April 29, 1993, the same aircraft successfully executed a minimum-radius, 180-degree turn using a post-stall maneuver, flying well beyond the aerodynamic limits of any conventional aircraft. This first-time maneuver has been dubbed the "Herbst maneuver" after Wolfgang Herbst, a German proponent of using post-stall flight in air-to-air combat. The maneuver has also been described as a "J" turn when flown to an arbitrary heading change. See figure 3-25 for a photo of the No. 2 X-31 in flight.



Figure 3-25. The second X-31 Enhanced Fighter Maneuverability (EFM) aircraft flies over Edwards Air Force Base, California. The X-31 EFM demonstrator flew at Dryden Flight Research Center, Edwards, California, from February 1992 until 1995, and before that at the Air Force's Plant 42 in Palmdale, California. (NASA-DFRC photo EC93-41056-1).

During the final phase of evaluation, the X-31s engaged in simulated air combat scenarios against adversaries flying F/A-18s and other tactical aircraft. By using post-stall maneuvers, the X-31s outperformed other aircraft without thrust vectoring.

The X-31 constituted a revolution in air combat in the post-stall region. Although they were opposed to trading off other important fighter characteristics to acquire EFM capabilities, the X-31 pilots concluded that the improved pitch pointing and velocity-vector maneuvering permitted by thrust-vector control provided new options for the pilot to use in close-in combat. When used selectively and rapidly, post-stall maneuvering allowed a pilot to rotate and point the nose of the aircraft at the adversary aircraft in such a way that the adversary pilot could not counter the maneuver. The X-31 also greatly improved flight safety since it was fully controllable and flyable in the post-stall region, unlike other fighter aircraft without thrust vectoring.

Despite the X-31's greater safety, the No. 1 X-31 aircraft crashed in an accident on January 19, 1995. The pilot ejected safely before the aircraft crashed in an unpopulated desert area north of Edwards. A Mishap Investigation Board concluded that an accumulation of ice in or on the unheated pitot-static system on the aircraft provided false airspeed information to the flight-control computers, causing the aircraft to go out of control and crash.²⁴⁵

The X-31 program logged an X-plane record of 580 flights (559 research missions and 21 in Europe for the 1995 Paris Air Show). A total of 14 pilots representing all agencies of the ITO flew the aircraft.

²⁴⁵ Don Haley, "Ice the Cause of X-31 Crash," NASA Dryden X-Press, December 1995, <http://www.dfrc.nasa.gov/Newsroom/X-Press/1995/xp-95-12.html> (accessed June 8, 2006).

In 1994, researchers installed software in the X-31 to assess the feasibility of stabilizing a tailless aircraft at supersonic speeds using thrust vectoring. The tests also included subsonic speeds.

During the flights, the pilot destabilized the aircraft with the rudder to stability levels that would be encountered if the aircraft had a reduced-size vertical tail. The X-31 quasi-tailless flight-test experiment demonstrated the feasibility of tailless and reduced-tail fighters. Had this capability been part of the airplane's design from the beginning, the benefits could potentially have outweighed the concept's complexity.

The X-31's enhanced maneuvering capabilities were demonstrated to the international aerospace industry during daily flights at the 1995 Paris Air Show. These flights featured post-stall maneuvers at low altitudes. The aircraft flew to Europe aboard a U.S. military C-5 transport. A small team of NASA and industry personnel supported it there.

The X-31 was the first international experimental aircraft development program administered by a U.S. government agency, and was a key effort of the NATO Cooperative Research and Development program. The program ended in June 1995.

In 1998, Dryden cooperated in a new X-31 research program called VECTOR (Vectoring, Extremely Short Takeoff and Landing, Control and Tailless Operation Research). The goal of the VECTOR program was to research advanced flight-enabling technologies using the X-31 aircraft. The first phase of the program, the program and requirements definition phase, began at Dryden on March 2, 1998, and ran through August 1998.²⁴⁶ This phase consisted of VECTOR

²⁴⁶ Gary Creech, "1st Phase of X-31 VECTOR Program Begins," NASA Dryden X-Press, April 3, 1998, <http://www.dfrc.nasa.gov/Newsroom/X-Press/1998/apr3/index.html> (accessed June 8, 2006). Also "X-31 Vector Program Phase 1 Begins," Dryden News Release 98-09, March 9, 1998, <http://www.nasa.gov/lb/centers/dryden/news/NewsReleases/1998/98-09.html> (accessed August 3, 2006).

multinational team negotiations for a memorandum of agreement, an X-31 aircraft parts count, a fit-check for a SAAB JAS-39 Gripen fighter RM-12 engine (GE F-404 engine derivative) in the X-31, and painting of the aircraft. The memorandum of agreement to conduct the VECTOR program was signed in April 1999 by the German and U.S. governments.²⁴⁷ VECTOR test flights began in January 2000.²⁴⁸ The X-31 VECTOR Cooperative Test Organization participants/partners were the U.S. Navy, Boeing, General Electric, NASA, the Swedish government, Volvo, SAAB, the German Ministry of Defense, and DASA (the Daimler-Benz consortium). See table 3-37 for X-31 characteristics.

X-36 Tailless Fighter Agility Research Aircraft. In 1989, Ames Research Center and Boeing's Phantom Works (McDonnell Douglas at the time) in St. Louis, Missouri, began developing the technologies required for tailless agile flight. In 1993, based on positive results from extensive wind tunnel tests and CFD analyses, McDonnell-Douglas proposed to build a remotely piloted scale aircraft technology demonstrator to validate the advanced technologies in a real flight environment.²⁴⁹ In 1994, the Phantom Works began fabricating two X-36 vehicles, the Tailless Fighter Agility Research Aircraft, using rapid prototyping techniques in its St. Louis facility.²⁵⁰

In 1997, the X-36 successfully carried out its flight research program. Thirty-one flights were made during the 25-week flight research program at Dryden and successfully demonstrated that future tailless fighters could achieve ability levels superior to the best current military fighter

²⁴⁷ "X-31 Vector at a Glance," <http://www.rjktech.com/html/x-31.html> (accessed August 3, 2006).

²⁴⁸ "History: X-31A Test Vehicle," <http://www.boeing.com/history/bna/x31.htm> (accessed August 3, 2006).

²⁴⁹ *Aeronautics & Space Transportation Technology; Three Pillars for Success: Turning Goals Into Reality, Annual Progress Report 1997-1998*, National Aeronautics and Space Administration Office of Aeronautics and Space Transportation Technology, NP-1998-10-242-HQ, p. 62.

²⁵⁰ "X-36 Tailless Fighter Agility Research Aircraft: Project Summary," Fact Sheets, Dryden Flight Research Center, <http://www.nasa.gov/centers/dryden/news/FactSheets/FS-065-DFRC.html> (accessed August 2, 2006).

aircraft. The first flight took place on May 17, 1997, when the aircraft reached an altitude of approximately 4,900 feet (1,494 meters) in a 5-minute flight (see figure 3-26). The second flight took place on May 22, lasted about 17 minutes, and reached an altitude of approximately 12,000 feet (3,658 meters).²⁵¹ The final flight, which closed out the third phase of the program, took place on November 12, 1997, and lasted 34 minutes. The X-36 flew a total of 15 hours 38 minutes, and used four different versions of flight-control software. It reached a maximum altitude of 20,200 feet (6,157 meters) and a maximum AoA of 40 degrees, and achieved a speed of 206 knots (234 miles per hour).²⁵² All flights were made using aircraft No. 1. The second aircraft was assembled and used only for low-speed taxi tests.²⁵³

²⁵¹ Gary Creech, "X-36 Takes to DFRC Sky," Dryden X-Press, June 6, 1997, <http://www.dfrc.nasa.gov/Newsroom/X-Press/1997-xp-97-11.html> (accessed June 8, 2006).

²⁵² "X-36 Tailless Fighter Agility Research Aircraft: Project Summary," Fact Sheets, Dryden Flight Research Center, <http://www.nasa.gov/centers/dryden/news/FactSheets/FS-065-DFRC.html> (accessed August 2, 2006).

²⁵³ Mark Sumich, X-36 Project Manager, e-mail to author, August 3, 2006.



Figure 3-26. The remotely piloted X-36 Tailless Fighter Agility Research Aircraft lifts off on its first flight from Rogers Dry Lake at the Dryden Flight Research Facility on 17 May 1997. The aircraft flew for 5 minutes and reached an altitude of approximately 4,900 feet (1,493 meters) (NASA photo EC97-44064-3, by Carla Thomas).

During the final flight phase, the X-36 project team examined the aircraft's agility at low speed/high AoAs and at high speed/low AoAs. The aircraft's stability and handling qualities were excellent at both ends of the speed envelope.

In December 1998, Ames transferred control of the X-36 aircraft to Dryden for use in a follow-on program called the Reconfigurable Control for Tailless Fighter Aircraft (RESTORE). The RESTORE program used advanced flight-control software to compensate for inflight damage or malfunctioning effectors (such as flaps, ailerons, and rudders). The Air Force Research Laboratory (AFRL) contracted with Boeing to fly the RESTORE software and demonstrate the adaptability of the neural-net algorithm. Two flights were flown in December 1998, proving the

viability of the software approach.²⁵⁴ The RESTORE flight tests were a joint effort funded by the AFRL, NASA, and the Naval Air Systems Command.²⁵⁵

The X-36 was a 28-percent scale representation of a theoretical advanced fighter aircraft configuration. It was designed to fly without the traditional tail surfaces that are common on most aircraft. Instead, a canard forward of the wing was utilized, in addition to split ailerons and an advanced thrust-vectoring nozzle for directional control. The aircraft was unstable in both the pitch and yaw axes; therefore, an advanced single-channel, digital, fly-by-wire control system, developed with some commercially available components, was used to stabilize the aircraft.

The aircraft were 18 feet (5.5 meters) long by 3 feet (0.9 meter) high, with a 10-foot (3-meter) wingspan. Fully fueled they weighed approximately 1,270 pounds (576 kg). A Williams Research F112 turbofan engine providing 700 pounds (3,114 newtons) of thrust powered the aircraft. They were remotely controlled by a pilot in a ground station cockpit, complete with a head-up display. The pilot-in-the-loop approach eliminated the need for expensive and complex autonomous flight-control systems.

The X-36 aircraft were built by Ames and Boeing under a cooperative agreement. Ames provided government oversight. NASA and Boeing were full partners in the project, which was jointly funded under a roughly 50/50 cost-sharing arrangement. The combined program cost for

²⁵⁴ “X-36 Makes Lakebed Appearance,” Research Roundup, Dryden X-Press, May 1, 1998, <http://www.dfrc.nasa.gov/Newsroom/X-Press/1998/jul3/roundup.html> (accessed June 8, 2006). Also “X-36 Tailless Fighter Agility Research Aircraft: Project Summary,” Fact Sheets, Dryden Flight Research Center, <http://www.nasa.gov/centers/dryden/news/FactSheets/FS-065-DFRC.html> (accessed August 2, 2006).

²⁵⁵ “NASA Ames Transfers Control of X-36 Tailless Jet Fighter to NASA Dryden for Future Flight Tests,” Dryden News Release, December 9, 1998, <http://www.nasa.gov/lb/centers/dryden/news/NewsReleases/1998-98-82.html> (accessed August 3, 2006).

developing, fabricating, and flight-testing the two prototype aircraft was approximately \$21 million. In the flight-test phase, Dryden provided the flight-test experience, infrastructure, and range support.

High Angle-of-Attack Technology Program (HATP)

HATP began as a formal program in 1985 to explore and understand aircraft flight at high AoAs. The program's primary objectives were to provide flight-validated aircraft design tools and to improve the maneuverability of aircraft at high AoAs. Langley Research Center managed the program in partnership with Ames, Dryden, and Lewis. Langley also performed subscale wind tunnel tests, advanced control-law synthesis, and CFD. Ames contributed additional CFD work and the use of its 80- by 120-foot (24.3- by 36.6-meter) wind tunnel. Lewis worked on inlet and engine integration, and Dryden performed the flight research. Other partners came from industry, academia, and the DOD, as well as NATO. HATP produced technical data from actual flights at high AoAs to validate computer codes and wind tunnel research. Successful validation of these data gave engineers and aircraft designers a better understanding of aerodynamics, the effectiveness of flight controls, and airflow phenomena at high AoAs.²⁵⁶

NASA selected a McDonnell Douglas F-18 Hornet fighter aircraft for a large part of its high-AoA research. It became known as the F-18 HARV after it was rebuilt and modified for the program. NASA used this aircraft in its attempts to expand what researchers called the “stall

²⁵⁶ “Past Projects: F-18 High Alpha Research Vehicle (HARV), Background, <http://www.nasa.gov/centers/dryden/history/pastprojects/HARV/background.html> (accessed August 4, 2006).

barrier” (the tendency of an aircraft to stall and become uncontrollable at high AoAs and slow speeds, which greatly limits its performance and maneuverability).²⁵⁷

The High Alpha Research Vehicle (HARV) program lasted from April 1987 until September 1995, and the aircraft completed 385 research flights.²⁵⁸ It demonstrated stabilized flight at AoAs between 65 and 70 degrees using thrust-vectoring vanes, a research flight-control system, and forebody strakes (hinged structures on the forward side of the fuselage to provide control by interacting with vortices, generated at high AoAs, to create side forces).²⁵⁹

The HARV program was a three-phased flight research effort. Phase 1, which lasted from April 1987 through 1989, consisted of 101 research flights in the specially instrumented but externally unmodified F-18 at AoAs as high as 55 degrees. The purpose of this phase was to obtain experience with aerodynamic measurements at high AoAs and to develop the flight research techniques needed for this measurement. In 1987, NASA selected McDonnell Douglas Corporation to equip the aircraft with a thrust-vector control system about the pitch and yaw axes to be used in the second phase of the program. The easily programmable flight-control system allowed research into flight-control concepts that used various blends of aerodynamic and thrust-vector control at subsonic and high-AoA flight conditions.²⁶⁰

²⁵⁷ Lane Wallace, *Flights of Discovery: 50 Years at the NASA Dryden Flight Research Center* (Washington, DC: NASA SP-4309, 1996), p. 103.

²⁵⁸ The aircraft is sometimes referred to as the High Angle-of-Attack Research Vehicle.

²⁵⁹ “Past Projects: F-18 High Alpha Research Vehicle (HARV),” Dryden Flight Research Center Fact Sheet, <http://www.nasa.gov/centers/dryden/history/pastprojects/HARV/index.html> (accessed August 4, 2006).

²⁶⁰ “McDonnell Douglas Selected for Contract Negotiation,” NASA Ames Research Center News Release 87-23, 1 May 1987, NASA History Division folder 33791, Historical Reference Collection, NASA Headquarters, Washington, DC.

Phase 2 flights examined the benefits of using vectored thrust to achieve greater maneuverability and control at high AoA while continuing the correlation of flight data with wind tunnel and CFD data begun in Phase 1. The initial portion of the Phase 2 flight program was completed in January 1993.

Phase 2 featured major hardware and software modifications to the HARV: a multiaxis thrust-vectoring control system featuring vanes attached to the aft end of the aircraft, and a research flight-control system. Three paddle-like vanes made of Inconel®1 metal were mounted around each engine's exhaust. The paddles could withstand temperatures of almost 2,000°F (1,093°C) and could rotate up to 25 degrees into the engine exhaust to help control the aircraft's pitch and yaw.²⁶¹ The thrust-vectoring control system added 2,200 pounds (998 kilograms) to the weight of the aircraft. In addition, the inclusion of a spin parachute for safety, plus an emergency power system and ballast, added a further 1,500 pounds (680 kilograms). The HARV also carried 419 pounds (190 kilograms) of other equipment and wiring not directly associated with the thrust-vector control system.

The research flights began in July 1991 using the thrust-vectoring system for control. The system could deflect the exhaust flow from the two turbofan engines to provide enhanced maneuverability and control in areas where conventional aerodynamic controls were ineffective. The system resulted in significantly increased maneuverability at moderate AoAs and some degree of control at AoAs up to roughly 70 degrees. It also allowed researchers to collect more data by remaining at high AoAs longer than they could without it. The pilot used standard cockpit controls, and no special pilot action was required after the flight-control system was

²⁶¹ Wallace, p. 105.

engaged in flight. In addition to the research flight-control computers, pilots also used the original F-18 flight-control system both as a backup to the research system and during takeoffs and landings. Dryden research pilots completed the envelope expansion flights in February 1992. Demonstrated capabilities included stable flight at approximately 70 degrees AoA (the previous maximum was 55 degrees) and rolling at high rates at 65 degrees AoA. Controlled rolling would have been nearly impossible above 35 degrees without vectoring.²⁶²

Between January 1993 and January 1994, the aircraft was modified with an engine inlet pressure measurements system between the inlet entrance and the engine face. With the information provided by this system, researchers gained an unprecedented understanding of what happens to engine airflow under extreme maneuver conditions. Flights resumed in January 1994 and continued through June 1994, with Dryden research pilots joined for short periods by U.S. Navy pilots. There were 193 flights during Phase 2, including some transition flights to Phase 3.

Phase 3 began in March 1995. During this phase researchers evaluated moveable strakes added on both sides of the aircraft's nose to provide yaw control at high AoAs where conventional rudders became ineffective. The F-18 was outfitted with two retractable nose strakes 4 feet (1.2 meters) long and 6 inches (15 centimeters) wide, hinged on one side and mounted to the forward sides of the fuselage. At low AoAs, they were folded flush against the aircraft skin. At higher AoAs, they were extended to interact with the strong vortices generated along the nose, thereby producing large side forces. This significantly improved controllability of the aircraft in high-

²⁶² "Past Projects: F-18 High Alpha Research Vehicle (HARV)," Dryden Flight Research Center Fact Sheet, <http://www.nasa.gov/centers/dryden/history/pastprojects/HARV/index.html> (accessed August 4, 2006).

AoA conditions.²⁶³ Wind tunnel tests indicated that strakes could be as effective at high AoAs as rudders were at lower AoAs.

Flights with active moveable strakes began in July 1995. The strakes enabled pilots to use three separate flight modes. One used thrust vectoring alone. A second used thrust vectoring for longitudinal (pitch) control and a blend of thrust vectoring and strakes for lateral (side-to-side) control. A third mode used thrust vectoring solely for longitudinal control, with strakes alone for controlling lateral motion. These three options were a unique feature of the HARV project and afforded a great deal of flexibility in research into control power requirements at high AoAs. They were also a way to achieve detailed information about handling qualities at high AoAs.

The project yielded a great deal of information about the operation of nose strakes, which were effective in providing control above 35 degrees AoA. Extending one or both of the strakes resulted in strong side forces that in turn generated yaw control. This approach, along with the aircraft's thrust-vectoring control system, improved stability under flight conditions in which conventional surfaces, such as vertical tails, were ineffective.²⁶⁴ Phase 3 included 109 flights flown by pilots from Dryden, Langley, and a number of guest pilots from the U.S. Navy and Marine Corps, the Canadian Air Force, the (British) Royal Air Force, McDonnell Douglas, and CalSpan.²⁶⁵ The strake project concluded in September 1996 with flight 385 of the HARV program. Figure 3-27 shows a flight test during the final phase of the program.

²⁶³ Wallace, p. 105.

²⁶⁴ "F-18 HARV Smoke Flow Visualization of Actuated Nose Strakes," <http://www.dfr.nasa.gov/Gallery/Photo/F-18HARV/HTML/EC96-43479-5.html> (accessed February 14, 2007).

²⁶⁵ "Past Projects: F-18 High Alpha Research Vehicle (HARV)," Dryden Flight Research Center Fact Sheet, <http://www.nasa.gov/centers/dryden/history/pastprojects/HARV/index.html> (accessed August 4, 2006).



Figure 3-27. This photo shows a smoke-flow visualization of actuated nose strakes with the F-18 High Alpha Research Vehicle (HARV) (NASA-DFRC photo EC96-43479-5).

In 1998, the F-18 HARV was refurbished for an intended return to flight status in the Active Aeroelastic Wing (AAW) project. Initial refurbishment included changing the landing gear, and further modifications were planned.²⁶⁶ The AAW project focused on developing and applying aeroelastic wing concepts, or “wing warping,” through the use of traditional ailerons and leading-edge flaps to literally twist a flexible wing, thereby improving roll maneuvering capability.²⁶⁷ However, a decision was made to use only the wings from the-retired F-18 HARV,

²⁶⁶ “HARV, Meet AAW!” Dryden X-Press, March 6, 1998, <http://www.dfrc.nasa.gov/Newsroom/X-Press/1998/mar/roundup.html> (accessed June 8, 2006).

²⁶⁷ “F-18 No. 940 Gearing Up for AAW,” Dryden X-Press, April 17, 1998, http://www.dfrc.nasa.gov/Newsroom/X-Press/1998/apr17_roundup1.html (accessed June 8, 2006). Also “Back to the Future: Active Aeroelastic Wing Flight Research,” NASA Dryden Fact Sheet, <http://www.nasa.gov/centers/dryden/news/FactSheets/FS-061->

modified for the AAW flight research program and installed on an AAW test aircraft obtained from the U.S. Navy in 1999. Flight tests began in 2002. See table 3-38 for F-18 HARV characteristics.

SR-71 Blackbird

NASA used two SR-71 aircraft as testbeds for high-speed, high-altitude aeronautical research.²⁶⁸ The two planes used by NASA had been developed for the U.S. Air Force as reconnaissance aircraft and were based at Dryden Flight Research Center. The aircraft were the fastest and highest-flying in the world, and as research platforms they could cruise at Mach 3 for more than an hour. For thermal experiments, this produced heat-soak temperatures of more than 600°F (316°C). This operating environment made the aircraft an excellent platform for research and experiments in areas such as aerodynamics, propulsion, structures, thermal protection materials, high-speed and high-temperature instrumentation, atmospheric studies, and sonic-boom characterization.

The first in a series of flights using the SR-71 as a science camera platform for NASA's Jet Propulsion Laboratory took place in March 1993. Mounted in the nosebay of the aircraft, an upward-looking ultraviolet video camera studied a variety of celestial objects in wavelengths that were blocked to ground-based astronomers.

The aircraft was also used in a program studying ways to reduce sonic booms. Instruments at precise locations on the ground recorded the sonic booms as the aircraft passed overhead at

DFRC.html (accessed August 4, 2006). "Wing-warping" was used by the Wright brothers in their first successful flight in 1903.

²⁶⁸"Past Projects—SR-71 Blackbird," <http://www.nasa.gov/centers/dryden/history/pastprojects/SR71/index.html> (accessed June 8, 2006).

known altitudes and speeds. The flights, which were conducted for Langley Research Center as a part of NASA's HSR program, took place from February through May 1995 near Edwards Air Force Base, California. During the study, engineers recorded how sonic booms were affected by the atmosphere.²⁶⁹ An F-18 subsonic aircraft and an F-16XL also flew near the SR-71 to measure the sonic boom at distances as close as 200 feet (61 meters) below and to the rear.

One of Dryden's SR-71s was used for the joint NASA, Rocketdyne, and Lockheed Martin Linear Aerospike SR Experiment (LASRE) in which the aerospike engine developed for the X-33 RLV was mounted on the back of the SR-71 (see figure 3-28). The experiment was designed to provide inflight data to help Lockheed Martin evaluate the handling and aerodynamic characteristics of the SR-71 linear aerospike experiment configuration and to validate the computational predictive tools it was using to determine the aerodynamic performance of a future RLV. The LASRE completed seven initial research flights at Dryden. On the first flight, on March 4, 1998, the aircraft flew for 1 hour 50 minutes, reaching a maximum speed of Mach 1.2. The engine was not fired during any of the flights.²⁷⁰ The experiment was completed in November 1998.²⁷¹ (See the material on the X-33 later in this chapter for more details.)

²⁶⁹ Don Haley, "SR-71 and F-16XL To Study Sonic Booms for High Speed Program, NASA Dryden X-Press, February 1995, <http://www.dfrc.nasa.gov/Newsroom/X-Press/1995/xp-95-02.html> (accessed June 8, 2006).

²⁷⁰ "Linear Aerospike SR-71 Experiment (LASRE) First Flight," <http://www.dfrc.nasa.gov/Gallery/Photo/SR-71-LASRE/HTML/EC97-44295-99.html> (accessed February 14, 2007). Also "Linear Aerospike SR-71 Experiment (LASRE) During First In-flight Cold Flow Test," <http://www1.dfrc.nasa.gov/gallery/photo/SR-71-LASRE/HTML/EC98-44440-13.html> (accessed February 15, 2007).

²⁷¹ "SR-71 Blackbird," Dryden Flight Research Center Fact Sheet, <http://www.nasa.gov/centers/dryden/news/FactSheets/FS-030-DFRC.html>. Also "Past Projects—SR-71 Blackbird," <http://www.nasa.gov/centers/dryden/history/pastprojects/SR71/index.html> (both accessed June 8, 2006).



Figure 3-28. 10A NASA SR-71 made its first successful flight 31 October 1997 as part of the NASA/Rocketdyne/Lockheed Martin Linear Aerospike SR-71 Experiment (LASRE) at Dryden Flight Research Center (NASA-DFRC photo EC97-44295-51).

The two SR-71s at Dryden were assigned NASA tail numbers NASA 844 (A model, military serial 64-17980, manufactured in July 1967) and NASA 831 (B model, military serial 61-7956, manufactured in September 1965). From 1991 through 1994, Dryden also had another “A” model: NASA 832 (military serial 61-7971, manufactured in October 1966). This aircraft was

returned to the Air Force inventory and was the first aircraft reactivated for Air Force reconnaissance purposes in 1995.²⁷²

The last SR-71 flight took place in October 1999. See table 3-39 for SR-71 characteristics.

Highly Integrated Digital Electronic Control (HIDEC) Flight Facility

NASA used a unique F-15A that was highly instrumented and equipped with an integrated digital electronic flight-control system. The aircraft was obtained from the U.S. Air Force on 5 January 1976 and flown over a broad flight envelope into the 1990s to carry out complex and sophisticated research projects. NASA used it for more than 25 advanced research projects involving aerodynamics, performance, propulsion control, control integration, instrumentation development, human factors, and flight-test techniques.²⁷³

The major elements of the HIDEC were a Digital Electronic Flight Control System (DEFCS); a Digital Electronic Engine Control (DEEC); an on-board, general purpose computer; and an integrated architecture to allow all components to communicate with each other. Unlike standard F-15s, which had both a mechanical and an analog electronic flight-control system, the F-15 HIDEC had a dual-channel, failsafe, digital flight-control system that could be programmed in high-order computer languages. It was linked to the H009 and Military Standard 1553B data buses, which tied all other electronic systems together.

²⁷² “Past Projects–SR-71 Blackbird,” <http://www.nasa.gov/centers/dryden/history/pastprojects/SR71/index.html> (accessed February 15, 2007).

²⁷³ “F-15 HIDEC (Highly Integrated Digital Electronic Control),” <http://www.nasa.gov/lb/centers/dryden/history/pastprojects/HIDEC/index.html> (accessed August 17, 2006).

The Adaptive Engine Control System (ADECS) on board the F-15 traded an excess engine stall margin for improved performance. This was achieved through the integrated and computerized flight and engine control systems. The engine stall margin—the amount by which engine operating pressures must be reduced to provide a margin of safety against an engine stall from excessive pressure—was continually monitored and adjusted by the integrated system, based on the flight profile and real-time performance needs. Initial ADECS engineering work began in 1983. Research and demonstration flights with the ADECS system, which began in 1986, displayed increases in engine thrust of 8–10.5 percent (depending on altitude), and up to 16 percent lower fuel consumption at 30,000 feet (9,144 meters) and constant thrust. Overall, engine performance improvements (rate of climb and specific excess power) ranged from 10 to 25 percent at maximum afterburning power. No stalls were encountered during even aggressive maneuvering, although intentional stalls were induced to validate the ADECS methodology.

During late 1989 and early 1990, researchers used the F-15 HIDECA aircraft to investigate what could become a major breakthrough in airborne flight-control capability. It was the first aircraft to demonstrate a Self-Repairing Flight Control System (SRFCS). The program, sponsored by the U.S. Air Force, demonstrated the ability of a flight-control system to identify a failed control surface and reconfigure commands to other control devices, such as ailerons, rudders, elevators, and flaps, to continue the aircraft's mission or to allow it to land safely. The SRFCS could also identify failures in electrical, hydraulic, and mechanical systems. When a failure in a normal flight-control system occurred, ground maintenance diagnostic tests had to be conducted to identify the origin of the failure so that appropriate corrective actions could be taken. Ground maintenance crews often spent up to 60 percent of their time attempting to duplicate flight

failures and correcting them. In many cases, the failure could not be identified on the ground because actual flight conditions could not be duplicated. This could be costly and time-consuming. System malfunctions on an aircraft with an SRFCS could be identified and isolated when they occurred and then repaired as soon as the aircraft was on the ground. Among the participants in the SRFCS research program, along with NASA, were the Air Force Wright Research and Development Center, Wright-Patterson Air Force Base, McDonnell Aircraft Co., and General Electric Aircraft Control Systems Division.

In the summer of 1990, the Performance Seeking Control (PSC) program began research flights with the F-15 HIDEAC to optimize total aircraft engine performance during steady-state engine operation. Previous modes used on the HIDEAC aircraft used stored schedules of optimum engine pressure ratios for an average engine on a normal day. Using digital flight control, inlet control, and engine control systems, PSC used integrated control laws to assure that peak engine and maneuvering performance would be available to the pilot at all times, regardless of the mission or immediate needs. The PSC program sought to reduce fuel usage at cruise conditions, maximize excess thrust during accelerations and climbs, and extend engine life by reducing the fan turbine inlet temperature. It also developed methods within the digital engine control system to detect degradation of components. This type of information, coupled with normal preventative maintenance, could help ensure failsafe propulsion systems in future high-performance aircraft.

Several accidents in which part or all of an aircraft's flight-control system was lost prompted Dryden to establish a research area to investigate the ability of an aircraft to use only engine thrust for flight control. In the Propulsion Controlled Aircraft (PCA) program, a modified F-15

was the first aircraft to use this capability intentionally. Initial flight studies with the pilot manually controlling the throttles and all F-15 flight controls locked showed that it was possible to maintain gross control. Altitude could be maintained within a few hundred feet using both throttles together. To climb, thrust could be added; to descend, thrust could be reduced. Heading could be controlled to within a few degrees using differential throttle to generate yaw, which resulted in roll. These initial flights also showed there was inadequate precise flight-control capability to land on a runway. This was due to the small control forces and moments of engine thrust, difficulty in controlling the airplane's shallow dive and climb motion, and difficulty in compensating for the lag in engine response.

The F-15 was an ideal testbed for this research. It incorporated digital engine and flight controls, and had a general-purpose computer and data bus architecture that allowed these digital systems to communicate with each other. There was also a cockpit computer panel for the pilot to make control-system inputs so as to select options and vary system gains. Tests of the PCA with the F-15 occurred at speeds of 150 knots (173 miles per hour) with the flaps down, and 170–190 knots (195.6–218.6 miles per hour) with the flaps up. Initial flights tested the “up and away” control capability, with landing approaches down to less than 10 feet (3 meters) above the ground. Flight tests of PCA at Dryden with the F-15 concluded with a successful landing on April 21, 1993 using only engine power to turn, climb, and descend. A successful follow-on program with an MD-11 transport aircraft conclusively demonstrated the success of the technology in 1995.²⁷⁴

Figure 3-29 shows the F-15 accompanied by an F-18 chase support aircraft.

²⁷⁴ “F-15 HIDEDEC (Highly Integrated Digital Electronic Controls,” <http://www.nasa.gov/centers/dryden/history/pastprojects/HIDEDEC/> (accessed August 17, 2006).



Figure 3-29. This photo shows the F-15 (on the left) accompanied by an F-18 chase support aircraft during its takeoff roll on a flight from Dryden (NASA photo EC91-677-1).

Hypersonics

NASA's research from 1989 to 1998 in the area of hypersonic flight related primarily to the National Aerospace Plane (NASP) and follow-on Hyper-X.

NASP (X-30)

The NASP program was conducted as a joint effort by NASA and the DOD to accelerate the development of technologies for a new class of hypersonic transatmospheric vehicles.²⁷⁵ Its goal

²⁷⁵ "Office of Aeronautics and Space Technology, Transatmospheric Research and Technology, Fiscal Year 1989 Estimates," p. RD 14-2.

was to develop and demonstrate the technologies needed to fly an aircraft into orbit by using air-breathing (ramjet/scramjet) propulsion instead of rockets. The program was originally conceived as a feasibility study for a single-stage-to-orbit (SSTO) vehicle that could take off and land horizontally on conventional runways. The plan was to develop and fly two aircraft, designated X-30, that featured an integrated aircraft body, engine, wings, fuel tank, and pilot compartment. Initially, the second aircraft was scheduled to fly into orbit by the mid-1990s.²⁷⁶

The program to develop the NASP began with a highly classified project, called Copper Canyon, that was initiated in 1982 by DARPA. Copper Canyon (which became Phase I of the NASP program) was the starting point for what President Ronald Reagan called “a new Orient Express,” an aircraft that could travel as fast as 25 times the speed of sound and reach Tokyo within two hours.²⁷⁷ The Copper Canyon phase of the program, which ran from 1982 to 1985, incorporated recent research in the areas of hypersonic propulsion, advanced materials and structures, and computational fluid dynamics. It consisted of concept definition and focused on scramjet technology.²⁷⁸

At the end of Phase I in 1985, NASA and the DOD were both optimistic that a hypersonic transatmospheric vehicle would be technically feasible. Phase II, the technology development phase, began in 1986. It consisted of the accelerated development of key technologies, airframe

²⁷⁶ Larry Schweikart, “Hypersonic Hopes: Planning for NASP, 1986–1991,” *Air Power History* 41, no. 1 (Spring 1994): p. 36.

²⁷⁷ Jenkins, Landis, and Miller, *American X-Vehicles: An Inventory—X-1 to X-50*, p. 38.

²⁷⁸ For a description of the early years of the program, see Judy Rumerman, *NASA Historical Data Book, Volume VI, 1979–1988* (Washington, DC: NASA SP-4012, 2000), pp. 222–224.

design, propulsion module development, and ground tests of the propulsion system up to Mach 8—the then-current practical limit of wind tunnels for engine tests.²⁷⁹

In 1988, the program outgrew DARPA's traditional research and development functions and moved to the Air Force in preparation for development of a flight-test vehicle. On March 31, 1988, an MOU was signed by NASA and the DOD outlining the responsibilities of each agency in the program.²⁸⁰ DOD was given responsibility for providing 80 percent of the program funding, with NASA providing the remaining 20 percent.

As NASA moved into 1989, the program included more than 5,000 people and involved some 200 companies in 40 states.²⁸¹ The budget and schedule as of 1989 called for the first flight to occur in 1997, and the first SSTO flight to occur by the year 2000.²⁸² However, funding for the program was becoming more difficult to obtain as the space station program competed for the same dollars. NASA's initial budget request for the NASP program in FY 1990, submitted in April 1989, was \$127 million—\$38 million more than it had received for the project in FY 1989. In April 1989, as part of the effort of the new administration of President George Bush to reduce the defense budget, Secretary of Defense Richard Cheney proposed canceling the DOD's funding of the NASP program (\$300 million in FY 1990) and transferring program management, along with \$100 million in FY 1990, from the DOD to NASA. NASA itself offered to take over management of the project, which would be converted from a flight vehicle test program into a

²⁷⁹ "The National Aerospace Plane Program," *Aerospace*, Spring 1986, p. 2.

²⁸⁰ "NASA/DOD Agree on Aerospace Plane MOU," *Defense Daily*, April 13, 1988, p. 256.

²⁸¹ "NASA Hopes To Maintain Increased Funding for NASP in FY 1990," *Defense Daily*, April 5, 1989, p. 18.

²⁸² Schweikart, p. 36.

technology development effort. NASA would conduct technology work for three to four years until the flight vehicle was defined and then request the DOD to fund the test vehicle.²⁸³

The issue was given to the NSC, chaired by Vice President Dan Quayle, to consider. The Council performed more detailed studies and advocates presented the program's benefits, maintaining its importance for the country's leadership in aerospace technology and tying it to the health of the U.S. aerospace industry in the next century.²⁸⁴ Recognizing that the program's high-risk technology required more time to mature, in late June the Council recommended providing additional time and funding for technology maturation and delaying for two and one-half years the decision as to whether to build the aircraft. The DOD would retain overall program management.²⁸⁵ Both the DOD and NASA would contribute \$127 million in FY 1990 (for a total of \$254 million), and total funding for FY 1991 and FY 1992 would be \$277 million (\$158 million from the DOD and \$119 million from NASA). FY 1993 funding would be \$305 million (\$233 million from the DOD and \$72 million from NASA).²⁸⁶

On July 25, 1989, President Bush approved the Council's recommendations, spurred partly by reports that the Soviet Union was testing aerospace plane designs along with the ramjet/scramjet engine technology required to produce a hypersonic cruise vehicle.²⁸⁷ As recommended by the

²⁸³ [no title], *Aviation Week & Space Technology* 130, no. 17 (May 1, 1989).

²⁸⁴ Schweikart, p. 44.

²⁸⁵ John D. Moteff, *National Aero-Space Plane*, CRS Issue Brief, Congressional Research Service, Updated January 2, 1991 (archived), p. CRS-4.

²⁸⁶ David P. Radzanowski and Marcia S. Smith, *The U.S. National Aero-Space Plane: A Comparison with Aero-Space Plane Programs in Other Countries, and Future U.S. Options*, CRS Report for Congress, Congressional Research Service, November 14, 1989, pp. CRS-1–CRS-2.

²⁸⁷ Radzanowski and Smith, *The U.S. National Aero-Space Plane: A Comparison with Aero-Space Plane Programs in Other Countries, and Future U.S. Options*, pp. CRS-1–CRS-2. Also Craig Covault, "Bush Administration Speeds NASP Review, Spurred by Soviet, German Competition," *Aviation Week & Space Technology* 130, no. 23 (June 5, 1989).

Council, the President's revised budget called for \$127 million from NASA and \$127 million from the DOD. Phase II would be extended an additional two and one-half years, and the decision as to whether to build the X-30 would not be made until March 1993. No date was given for the first test or first orbital flight. Because of the longer time allowed for technology development, total funding now ranged from \$3.7 billion to \$3.9 billion, in contrast to President Reagan's \$3.3 billion.

The final appropriations bill, approved by Congress in November 1989, provided \$194 million to the DOD for the NASP, but only \$35 million to NASA with the option to transfer an additional \$25 million from NASA's construction funds.²⁸⁸ It also endorsed the Council's plan to extend technology development until 1993 and retain an experimental flight vehicle focus and a joint program management structure with participation by both the DOD and NASA.²⁸⁹ In May 1990, the contractors working on the program received approval from the Air Force to a plan for a team structure whereby each contractor agreed to share data with the others.²⁹⁰

However, over the next two years the technological challenges proved daunting. In March 1993, work on the demonstrator ceased, and in June the Air Force and NASA canceled plans to develop a scramjet-powered SSTO demonstrator due to shrinking budgets and concerns voiced by the Defense Science Board that NASP technologies were insufficiently mature to warrant construction of a flight-test demonstrator. The project shifted from a piloted, hypersonic vehicle to focus on the more difficult technical issues. As newly defined, the X-30 program consisted of a dual-track, six-year-long project that would cost around \$2 billion. Engineers and researchers

²⁸⁸ Moteff, *National Aero-Space Plane*, p. CRS-5.

²⁸⁹ "Space Council Says NASP Now Has National Commitment," *Defense Daily*, November 21, 1989, p. 283.

²⁹⁰ Schweikart, pp. 45-46.

would continue to develop and refine the technologies needed for an air-breathing SSTO vehicle. At the same time, researchers would launch experimental packages atop surplus intercontinental ballistic missile boosters and use the data generated to verify computational codes and scramjet propulsion performance.²⁹¹ The DOD completely pulled out of the program soon after. In the FY 1994 budget, Congress reduced NASA's funding for the NASP by \$80 million.²⁹² In 1994, Congress directed that the program end while it was in the technology-development phase, and additional funding was not included in the FY 1995 budget.²⁹³

Accomplishments of the program included the fabrication of distinctive composite panels, tests of panel assemblies, and load tests of a new 600-gallon (2,271-liter) cryogenic fuel tank. Several wind tunnel tests were performed, including tests of a propulsion-integration model, mid-speed (Mach 6.8) scramjet tests that obtained performance and operability data from the one-third-scale Concept Demonstrator Engine, and complementary tests using smaller-scale scramjet models at Mach 4 to Mach 8 conditions. Shock-tunnel tests of large-scale scramjet-combustor models at Mach 10 to Mach 17 used advanced instrumentation, including laser-based systems and a metric strip, to provide new information. Analytic activities defined new boundary-layer instability modes and provided a series of computational modules for aerothermodynamic predictions.²⁹⁴

Figure 3-30 shows a 1990 artist's depiction of the plane.

²⁹¹ Stanley W. Kandebo, "NASP Cancelled, Program Redirected," *Aviation Week & Space Technology* 138, no. 24 (June 14, 1993): pp. 33–34.

²⁹² "Conference Report on H.R. 2491, Departments of Veterans Affairs and Housing and Urban Development and Independent Agencies Appropriations Act, 1994, House of Representatives, October 4, 1993.

²⁹³ "General Statement," Fiscal Year 1995 Budget Estimates, p. AS-7. Also "Aeronautical Research and Technology, Transatmospheric Research and Technology," Fiscal Year 1996 Estimates, http://www.hq.nasa.gov/office/budget/fy96/sat_4.html (accessed June 18, 2006).

²⁹⁴ "Aeronautical Research and Technology, Transatmospheric Research and Technology," Fiscal Year 1996 Estimates, http://www.hq.nasa.gov/office/budget/fy96/sat_4.html (accessed June 18, 2006).



Figure 3-30. Artist's concept of the X-30 aerospace plane flying through Earth's atmosphere on its way to low-Earth orbit (NASA-LaRC photo EL-2001-00432).

After the demise of the X-30 program and cancellation of the Transatmospheric R&T program, NASA used the NASP program's database as a starting point for its newly established multiyear Hyper-X hypersonic technology program, which was conducted jointly by Langley and Dryden.²⁹⁵ The goals of the program were to flight-validate key propulsion and related technologies, experimental techniques, computational methods, tool designs, and performance predictions for air-breathing hypersonic aircraft with airframe-integrated, hydrogen-fueled, dual-

²⁹⁵ "Office of Aeronautics, Hypersonic Technology Program," FY 1995 Budget Estimate. p. SAT 4-35.

mode combustion scramjet propulsion systems. Such systems promise to increase payload capacity or reduce vehicle size for the same payload in future hypersonic aircraft or reusable space launch vehicles.²⁹⁶ A major difference between the Hyper-X and NASP programs was that the NASP program had sought to integrate many new, untried technologies into a full-scale test vehicle. The Hyper-X program took an incremental approach, starting with the key scramjet engine technology. Although researchers originally planned to use four small-scale vehicles to save money and reduce risk, in 1997 the project consisted of three highly swept aircraft that were identical in appearance but had been engineered with slight differences that simulated engine inlet variable geometry. A team led by MicroCraft, Inc. (later ATK-GASL) was selected to fabricate three unpiloted research aircraft. The first Mach 7 hypersonic aircraft was initially scheduled to fly at Mach 7 in 1998, but by mid-1998 the date for the first flight had been pushed back to early 2000. The second and third vehicles were scheduled to fly at one-year increments.²⁹⁷ The first flight of the Hyper-X (designated X-43) in 2001 ended prematurely when the booster rocket veered off course and had to be destroyed before the test could begin. The second flight, in March 2004, flying at Mach 7, was successful. The third flight, flying in November 2004 at nearly Mach 9.8, was also successful.²⁹⁸ Figure 3-31 shows a 1997 Hyper-X configuration.

²⁹⁶ “Project Summary,” Dryden Flight Research Center, <http://www.nasa.gov/centers/dryden/research/HyperX/index.html> (accessed July 24, 2006). Also Scott D. Holland, William C. Woods, and Walter C. Engelund, “Hyper-X Research Vehicle Experimental Aerodynamics Test Program Overview,” *Journal of Spacecraft and Rockets* 38, no. 6 (November-December 2001): pp. 828–835, http://hapb-www.larc.nasa.gov/Public/Documents/JSR_HX_collection/p828_s.pdf (accessed July 24, 2006). Also “NASA ‘Hyper-X’ Program Established; Flights Will Demonstrate Scramjet Technologies, NASA Facts On Line, FS-1998-07-26-LaRC, July 1998, <http://oea.larc.nasa.gov/PAIS/Hyper-X.html> (accessed March 18, 1999, version no longer available on-line, archived at <http://web.archive.org/web/19981202004507/http://oea.larc.nasa.gov/PAIS/Hyper-X.html> [June 5, 2007]).

²⁹⁷ “NASA ‘Hyper-X’ Program Established; Flights Will Demonstrate Scramjet Technologies, <http://oea.larc.nasa.gov/PAIS/Hyper-X.html> (accessed March 18, 1999, version no longer available online).

²⁹⁸ “NASA ‘Hyper-X’ Program Demonstrates Scramjet Technologies,” NASA Dryden Fact Sheet, <http://www.nasa.gov/centers/dryden/news/FactSheets/FS-040-DFRC.html> and “NASA’s X-43A Scramjet Breaks

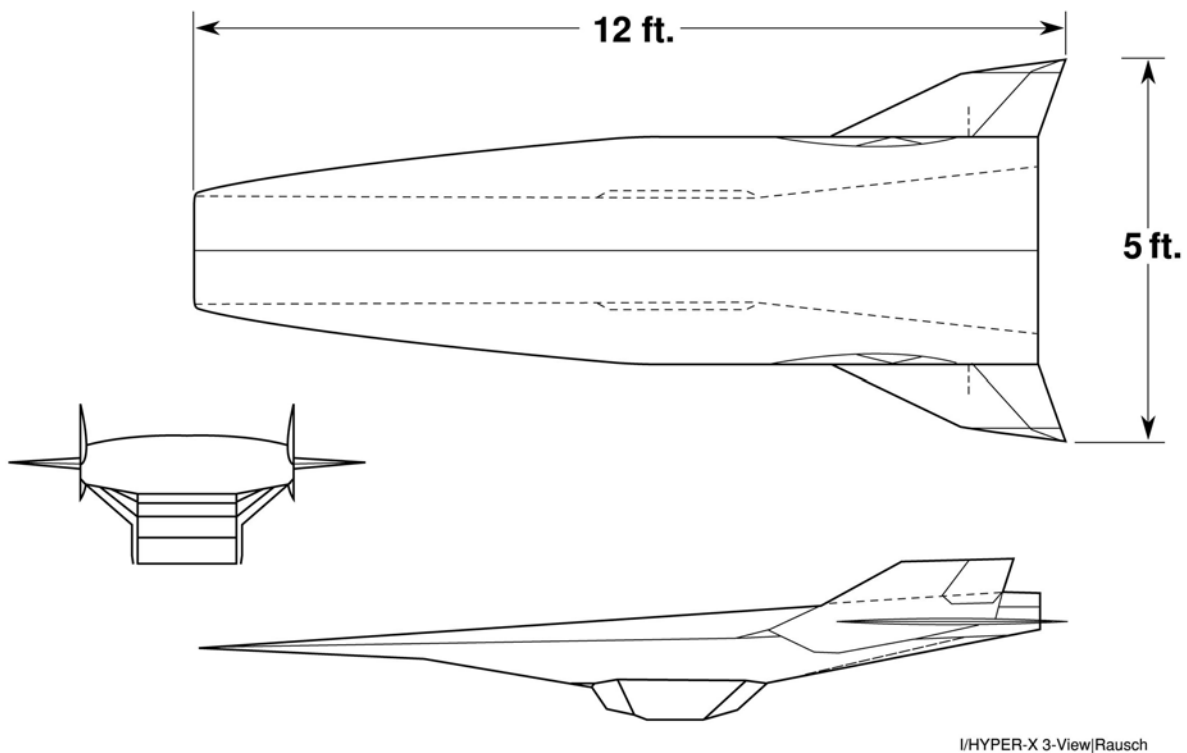

Figure 3-31. Hyper-X research vehicle configuration, 1997 (NASA-LaRC photo EL-1997-00033).

Wind Tunnel and Propulsion Test Facilities

During the period of 1989–1998, NASA’s major wind tunnel and propulsion test facilities were located at Ames, Langley, Lewis, and Marshall. All wind tunnels have certain features in common. Each has a test section in which an airplane model, a component, or an entire aircraft can be fixed or suspended. Test sections may vary in size from a few inches up to the 80- by 120-foot (24.3- by 36.6-meter) dimensions of Ames’ full-scale tunnel, currently the largest in the world. The test section may be open, closed, or ventilated, and the cross section may be of various shapes. Wind tunnels may be either “return” or “no-return” tunnels. No-return tunnels

Speed Record,” *NASA News Release 04-59*, November 16, 2004, http://www.nasa.gov/missions/research/x43_schedule.html (both accessed July 24, 2006).

draw air from the atmosphere, pass it through a tube that includes a test section, and discharge it into the atmosphere. A single-return tunnel passes the same air around a closed loop. The double-return tunnel is shaped like a squared figure 8 with the corners rounded and the test section located at the juncture of the two loops. Annular-return tunnels are doughnut-shaped in cross section. Longitudinally, they look like a tube within a capsule; air pushed around the inner shell of the capsule is channeled down the tube in the center, which contains the test section. Closed tunnels can be pressurized.²⁹⁹

Typically, NASA's wind tunnels are classified according to speed regime (subsonic [Mach 0 to Mach 0.7], transonic [Mach 0.7 to Mach 1.2], supersonic [Mach 1.2 to Mach 5], and hypersonic [above Mach 5]). The following section provides an overview of these facilities. Table 3-40 lists wind tunnels that were active during the years 1989–1998.

Ames Research Center

The **14-foot Transonic Wind Tunnel** began operating in 1955.³⁰⁰ It was used primarily for performance and stability and control testing of aircraft configurations. For conventional steady-state tests, models were supported on a cantilevered sting via a strut with variable pitch capability. A turntable was also available for semispan models. The tunnel had a test section measuring 13.5 by 13.71 by 33.75 feet (4.1 by 4.18 by 10.29 meters).³⁰¹ NASA closed the tunnel in 1997. Figure 3-32 shows a Boeing 747 model in this tunnel.

²⁹⁹ Alex Roland, *Model Research, Volume 2* (Washington, DC: NASA SP-4103, 1985), p. 508. Available at <http://history.nasa.gov/SP-4103/sp4103.htm>.

³⁰⁰ Baals and Corliss, *Wind Tunnels of NASA*, p. 64.

³⁰¹ Frank E. Peñaranda and M. Shannon Freda, comps and eds, *Aeronautical Facilities Catalogue, Volume 1, Wind Tunnels* (Washington, DC: National Aeronautics and Space Administration Scientific and Technical Information Branch, NASA RP-1132, 1985), p. 150

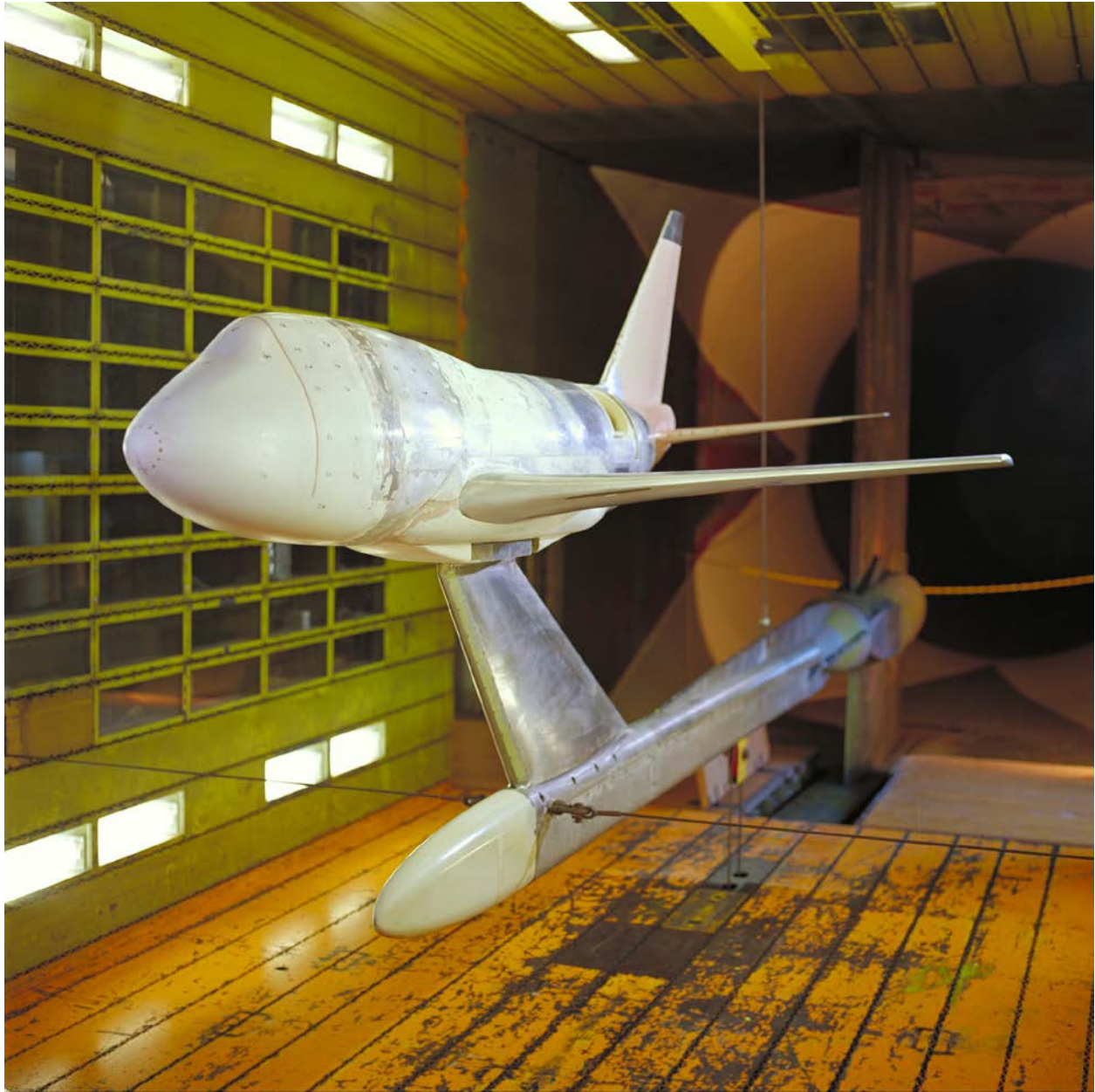

Figure 3-32. Photo of the Boeing 747-SP SOFIA model in the 14-foot wind tunnel, July 1994 (NASA-ARC photo AC94-0199-18).

Two **7- by 10-foot Subsonic Wind Tunnels** were built in 1941. Although the two were identical in design, the No. 1 tunnel was 7 feet by 10 feet by 16 feet (2.1 meters by 3 meters by 4.9 meters), and the No. 2 tunnel was the same diameter but 1 foot (0.3 meter) shorter. Both tunnels were closed-circuit, single-return, continuous-flow tunnels that were used to test rotorcraft,

vertical/short takeoff and landing, and conventional aircraft models. They were equipped with a high-pressure air system and a model motor variable-frequency power source.³⁰² Tunnel No. 2 had been used by the U.S. Army for decades. In 1996, when NASA decided to abandon tunnel No. 1, the Army took it over and refurbished it with a new control system, motor/generator set, and scales.³⁰³ Figure 3-33 shows a HSCT model being tested in the 7- by 10-foot (2.1- by 3-meter) tunnel.

³⁰² Peñaranda and Freda, *Aeronautical Facilities Catalogue, Volume 1, Wind Tunnels*, pp. 77–78.

³⁰³ Arthur Ragosta, Chief, Research Support Division, Army Aeroflightdynamics Directorate, e-mails to author, August 16 and 17, 2006.



Figure 3-33. This photo shows the Boeing High-Speed Civil Transport being tested in ultraviolet light with tufts in the no. 1 7- by 10-foot wind tunnel. (NASA-ARC photo AC96-0047-47).

The **Unitary Plan Wind Tunnel (UPWT)** was completed in 1956 under the Unitary Plan Act of 1949 at a cost of \$27 million, and has been designated a National Historic Landmark. Since its completion, the UPWT has been the most heavily used NASA wind tunnel. Every major

commercial transport and almost every military jet built in the United States during the 40 years since it began operating has been tested in the facility. The Mercury, Gemini, and Apollo capsules and the Space Shuttle were also tested in this tunnel complex. The UPWT included three test sections: an 11- by 11-foot (3.35- by 3.35-meter) transonic section, a 9- by 7-foot (2.7- by 2.1-meter) supersonic section, and an 8- by 7-foot (2.4- by 2.1-meter) supersonic section. The major element of the tunnel complex was its drive system that consisted of four intercoupled electric motors.³⁰⁴ All three test sections were closed-circuit, single-return, variable-density, continuous-flow wind tunnels used primarily for force, moment, and pressure tests of aircraft configurations or specific aircraft components. The UPWT did not operate during FY 1997–FY 2000 because of a facility modernization project.³⁰⁵ The three test sections of the UPWT are described below:

- The **11- by 11-foot Transonic Wind Tunnel** was a closed-return, variable-density tunnel with a fixed geometry, ventilated throat, and single-jack flexible nozzle. It was used for limited aeroacoustic and nonsteady aerodynamic tests. A three-stage compressor drove this tunnel with movable inlet guide vanes for fine Mach number control. Airflow was produced by a three-stage, axial-flow compressor powered by four wound-rotor, variable-speed induction motors. For conventional steady-state tests, models were generally supported on a string. A schlieren system, one that allowed regions of varying refraction in a transparent medium caused by pressure or temperature differences and detectable by photographing the

³⁰⁴“Unitary Plan Wind Tunnel,” Ames Research Center, November 2005, http://www.nasa.gov/centers/ames/pdf/146638main_unitarywindtunnel.pdf (accessed August 15, 2006). Also “Unitary Plan Wind Tunnel,” <http://www.cr.nps.gov/nr/travel/aviation/uni.htm> (accessed August 15, 2006).

³⁰⁵“Final Management Letter on Audit of Wind Tunnel Utilization,” Assignment Number A-03-007-00, Report Number IG-03-027, <http://oig.nasa.gov/audits/reports/FY03/pdfs/ig-03-027.pdf> (accessed August 15, 2006).

passage of a beam of light, was used to study flow patterns either with photographs or by direct viewing.³⁰⁶ Figure 3-34 shows a Boeing 777 being tested in the tunnel.



Figure 3-34. A Boeing 777 model in the 11-foot (3.35-meter) wind tunnel during testing in August 1991 (NASA-ARC photo AC91-0470-2).

³⁰⁶ Peñaranda and Freda, *Aeronautical Facilities Catalogue, Volume 1, Wind Tunnels*, p. 151. Also “Unitary Plan Wind Tunnel,” <http://www.cr.nps.gov/nr/travel/aviation/uni.htm> (accessed August 15, 2006).

- The **9- by 7-foot Supersonic Wind Tunnel** was a closed-circuit, variable-density tunnel. This tunnel was similar to the transonic wind tunnel except that it was equipped with an asymmetric sliding-block nozzle and the airflow was produced by an 11-stage, axial-flow compressor powered by four variable-speed, wound-rotor induction motors.³⁰⁷ Figure 3-35 shows a test of the HSCT in the tunnel.



Figure 3-35. A series of High-Speed Civil Transport wind-tunnel tests were conducted using the 9- by 7-foot tunnel from December 1993 to February 1994. (NASA-ARC Photo AC94-0057-7).

³⁰⁷ Peñaranda and Freda, *Aeronautical Facilities Catalogue, Volume 1, Wind Tunnels*, p. 201. Also “Unitary Plan Wind Tunnel,” <http://www.cr.nps.gov/nr/travel/aviation/uni.htm> (accessed August 15, 2006).

- **The 8- by 7-foot Supersonic Tunnel** was built in 1956. It was used for limited aeroacoustic and nonsteady aerodynamic tests. Internal strain-gage balances were used to measure forces and moments. The support strut had both variable pitch and yaw capability plus or minus 15 degrees.³⁰⁸ The tunnel closed in 1998.

The **12-foot Pressure Wind Tunnel**, originally built in 1946, was a closed-circuit, single-return, variable-density, closed-throat wind tunnel with exceptionally low turbulence. It was used primarily for high Reynolds number testing, including the development of high-lift systems for commercial transports, high-AoA testing of maneuverable aircraft, and high Reynolds number research. Various model-support systems were available, including a strut with variable pitch capability, a high-AoA turntable system, a dual-strut turntable mechanism for high-lift testing, a semispan mounting system, and two-dimensional model-type mountings.³⁰⁹

The facility gradually suffered a deterioration of its pressure shell due to extensive use.

Reconstruction began in 1990 and included the complete rebuilding of the closed-loop pressure vessel and installation of an air lock system around the test section. The new air lock system allowed researchers to access to the test section without depressurizing the entire tunnel, which increased its productivity.³¹⁰ The rebuilt wind tunnel opened in 1994 and its dedication took place in August 1995.³¹¹ See figure 3-36 for a photo of an MD-11 model in the tunnel.

³⁰⁸ Peñaranda and Freda, *Aeronautical Facilities Catalogue, Volume 1, Wind Tunnels*, p. 203.

³⁰⁹ *Ibid.*, p. 107.

³¹⁰ “Unique NASA Wind Tunnel Restoration Completed,” *NASA News Release 94-193*, November 16, 1994, <ftp://ftp.hq.nasa.gov/pub/pao/pressrel/1994/94-193.txt> (accessed August 15, 2006).

³¹¹ “Refurbished Wind Tunnel To Open at NASA Ames Research Center, *NASA News Release 95-143*, August 21, 1995, <ftp://ftp.hq.nasa.gov/pub/pao/pressrel/1995/95-143.txt> (accessed August 15, 2006).

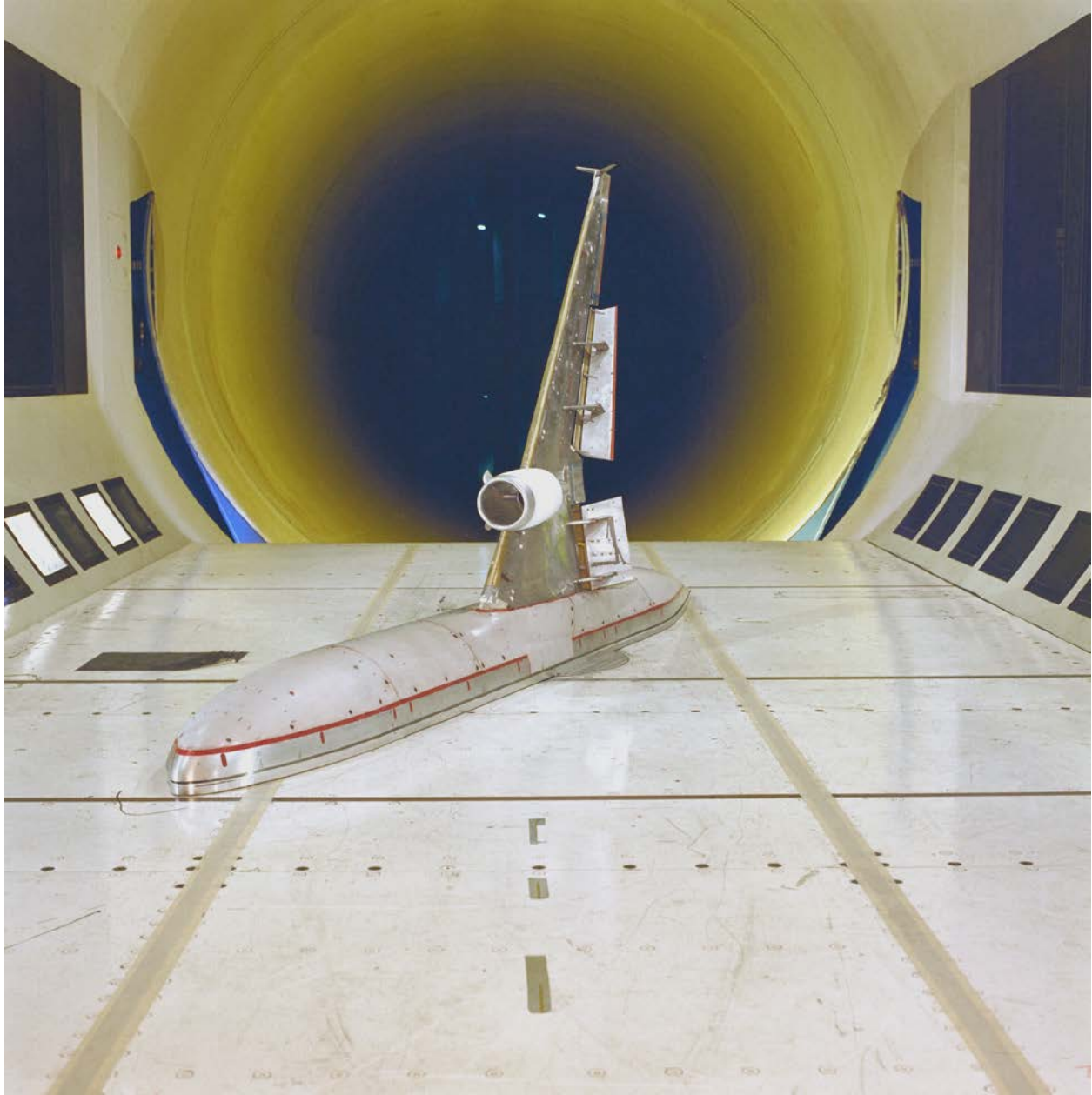

Figure 3-36. This photo shows the McDonnell Douglas MD-11 semi-span model test in the 12-foot wind tunnel, October 1995 (NASA-ARC photo AC96-0344-6).

The **National Full-Scale Aerodynamics Complex** (NFAC) consisted of two subsonic wind tunnels: one 40 by 80 feet (12.2 by 24.3 meters), and one 80 by 120 feet (24.3 by 36.6 meters). This complex could test planes with wingspans of up to 100 feet (30.48 meters).

The original 40- by 80-foot (12.2- by 24.3-meter) wind tunnel began operating in 1944. By the time the 80- by 120-foot (24.3- by 36.6-meter) section was built in 1982, more than 100 aircraft, from World War II fighters to the Space Shuttle, had gone through the 40- by 80-foot test section. The primary reason the new section was added was the need to test evolving vertical takeoff and landing (VTOL) aircraft at full scale.³¹²

The tunnels were used primarily to determine the low- and medium-speed aerodynamic characteristics of high-performance aircraft; rotorcraft; and fixed-wing, powered-lift vertical and short takeoff and landing (V/STOL) aircraft. NASA operated the facilities for industry, NASA, DOD, and other government projects, supporting an active research program in aerodynamics, dynamics, model noise, and full-scale aircraft and their components. The aerodynamic characteristics of new configurations were investigated, with an emphasis on validating computational methods. Rotor–fuselage interactions and the aeromechanical stability boundaries of advanced rotorcraft were explored. Stability and control derivatives, including the static and dynamic characteristics of new aircraft configurations, were also determined. The acoustic characteristics of most of the full-scale vehicles were also determined, and acoustic research aimed at discovering and reducing aerodynamic sources of noise was conducted. In addition to the normal data-gathering methods (e.g., balance system, pressure-measuring transducers, and temperature-sensing thermocouples), the use of state-of-the-art, nonintrusive instrumentation, such as laser velocimeters and shadowgraphs, helped determine flow direction and velocity in and around the lifting surfaces of models or aircraft undergoing investigation.

³¹² Baals and Corliss, *Wind Tunnels of NASA*, pp. 134–135.

The 40- by 80-foot (12.2- by 24.3-meter) tunnel had a closed test section with semicircular sides of 20-foot (6.1-meter) radius and a closed-circuit air return passage. The 80- by 120-foot (24.3- by 37.6-meter) tunnel also had a closed test section that was rectangular in cross section. It was a non-return tunnel. The two tunnels shared a common fan drive system, and only one tunnel could be operated at a time. By adjusting the position of vane sets 3 and 4, researchers could direct the airflow through the desired test section.

The test sections of both tunnels were lined with sound-absorptive material to permit acoustic and aerodynamic research to take place simultaneously. The 6-inch (15.2-centimeter)-deep lining in the 40- by 80-foot tunnel that covered the entire test section was replaced in 1993–1995 by new lining that was 42 inches (107 centimeters) deep.³¹³ The lining in the 80- by 120-foot tunnel test section was 10 inches (25.4 centimeters) deep on the walls and 6 inches (15.2 centimeters) deep on the floor and ceiling. These linings permitted near-anechoic (without echoes) tests to be performed above 500 hertz. With the acoustic liner installed, the test section dimensions for the 40- by 80-foot tunnel were 39 feet (11.9 meters) high, 79 feet (24.1 meters) wide (at the horizontal center line), and 80 feet (24.3 meters) long. The test section dimensions for the 80- by 120-foot tunnel were 79 feet (24.1 meters) high, 118.3 feet (36.1 meters) wide, and 190 feet (57.9 meters) long with the acoustic liner installed.

The air in the tunnel was driven by six 40-foot (12.2-meter)-diameter, 15-bladed, variable-pitch fans. The speed in the 40- by 80-foot tunnel test section continuously varied from 0 to 300 knots (345 miles per hour), while the speed in the 80- by 120-foot tunnel test section continuously

³¹³ “World’s Largest Wind Tunnel Will Be World’s Quietest,” *NASA News Release 93-81*, May 10, 1993, <ftp://ftp.hq.nasa.gov/pub/pao/pressrel/1993/93-081.txt> (accessed August 15, 2006).

varied from 0 to 100 knots (115 miles per hour). The stagnation pressure in the tunnel was atmospheric. The stagnation temperature was uncontrolled and depended on conditions such as outdoor temperature and the temperature rise contributed by the operation of internal combustion engines in the models or aircraft.³¹⁴ Figure 3-37 shows an engine test in the 40- by 80-foot tunnel. Figure 3-38 shows a parafoil undergoing testing in the 80- by 120-foot tunnel.



Figure 3-37. NASA engineers are shown preparing a laser light sheet for a flow visualization test of a Pratt & Whitney Advance Ducted Propulsor demonstrator engine in the Ames 40- by 80-foot wind tunnel in 1993 (NASA-HQ-GRIN photo GPN-2000-001521).

³¹⁴ “40- by 80- and 80- by 120-Foot Wind Tunnels,” http://rotorcrafterc.nasa.gov/facilities/40x80_80x120.html (accessed July 28, 2006).



Figure 3-38. The Pioneer Aerospace Parafoil undergoes testing in the world's largest wind tunnel, the 80- by 120-foot tunnel at NASA Ames Research Center, 1990. (NASA HQ-GRIN photo GPN-2000-001646).

NASA closed the complex in 2003 because of budget pressures.³¹⁵ In February 2006, a long-term lease was signed by NASA and the U.S. Air Force that turned operation of the complex over to the Air Force. As of the beginning of February 2007, plans were in place to reopen the facility,

³¹⁵ "National Full-Scale Aerodynamic Complex Set To Reopen," Air Force Link, <http://www.af.mil/news/story.asp?storyID=123016982> (accessed August 9, 2006).

and tests had been conducted successfully. Although the facility is owned by NASA, it receives support from the U.S. Army and is run by the U.S. Air Force.³¹⁶

Langley Research Center

The **0.3-meter Transonic Cryogenic Tunnel** was used to test two-dimensional airfoil sections and other models at high Reynolds numbers. The adaptive walls, floor, and ceiling in the 13- by 13-inch (33- by 33-centimeter) test section could be moved to the free-stream streamline shape, eliminating or reducing wall effects on the model. The Mach number, pressure, temperature, and adaptive wall shapes were automatically controlled. The test section had computer-controlled AoA and traversing wake survey rake systems. Two inches (5 centimeters) of honeycomb and two anti-turbulence screens (total of five screens) were added to the settling chamber. The contraction section was replaced with a scaled version of the National Transonic Facility contraction section. The normal test medium was gaseous nitrogen (GN_2), which was injected as a cryogenic liquid. Up to 56,000 gallons (211,983 liters) of liquid nitrogen (LN_2) could be stored in on-site tanks, which were refilled either by truck or directly by pipeline from a nearby manufacturing plant. The facility could also use air or a heavy gas (sulfur hexafluoride [SF_6]), with a restricted test envelope, as the test medium. Air and SF_6 were used only at ambient temperature and required the use of a heat exchanger.

The tunnel was oriented vertically with the test section and plenum, high-speed diffuser, screens, spacer, and contraction sections forming the upper leg. Under ambient conditions, the tunnel was approximately 38 feet (11.6 meters) between the centerlines of the vertical legs and

³¹⁶ Mark Betzina, Deputy Director of National Full-Scale Aerodynamic Complex, U.S. Army, NASA Ames Research Center, telephone conversation, February 13, 2007.

approximately 6 feet (1.8 meters) between the centerlines of the upper and lower legs. Because of the large operational temperature envelope, the stagnation end of the tunnel was free-floating and allowed to contract and expand along the length, width, and height of the tunnel. The fan housing section was the fixed point for the tunnel and enclosed the 12-bladed aluminum fan, bearing housing, and drive shaft connection. The fan was driven by a water-cooled, 3,000-horsepower, 4,600-volt, variable-frequency motor. The vent system, consisting of three 4-inch (10.1-centimeter) vent valves in the lower leg, maintained the tunnel at a desired pressure. The safety relief system was connected to the upper leg and prevented overpressurization of the tunnel. The relief valve and rupture disc lines were each sized to relieve the maximum nitrogen injection rate. The tunnel's interlocks and failsafe systems shut down and vented the appropriate systems when electric, lubrication, hydraulic, cooling water, or pneumatic systems failures or gas leaks were detected.

High-pressure (350 pounds per square inch/psi) and low-pressure (100 psi) air sources were available at the tunnel site. These sources were located outside the tunnel and could be used for such tasks as leak-checking the model orifices and calibrating auxiliary research devices.

Two-dimensional models spanning the 13-inch (33-centimeter) test section were supported in circular turntables on either side of the test section. An AoA range of -9 to $+32$ degrees could be attained by means of dual connecting rods attached to the turntables.³¹⁷

³¹⁷ "0.3M Transonic Cryogenic Tunnel," http://windtunnels.larc.nasa.gov/facilities_updated/aerodynamics/03m.htm (accessed July 5, 2006).

The **8-foot Transonic Pressure Tunnel** was a continuous-flow, variable-pressure wind tunnel with control capability to independently vary the Mach number, stagnation pressure, stagnation temperature, and humidity. The test section was square with corner fillets and a cross-sectional area approximately equivalent to that of an 8-foot (2.4-meter)-diameter circle. The top and bottom walls of the test section were axially slotted to permit the test section Mach number to vary continuously from 0.2 to 1.2, and the slot-width contour provided a gradient-free test section 50 inches (127 centimeter) long.³¹⁸ The tunnel had a sting-type model support system with an angle range of about ± 120 degrees and tunnel wall mounts. The stagnation pressure could be varied from below 0.25 atmosphere at any Mach number to 2.0 atmospheres at the 0.2 Mach number. At higher Mach numbers (up to 1.3), the pressure was limited by the available power of 25,000 horsepower. The stagnation temperature was controlled by water-cooled fans upstream of the settling chamber. Tunnel air could be dried to a dew point appropriate to the Mach number by a dryer using silica gel desiccant.³¹⁹ The special features of the tunnel included a laser light sheet flow visualization system, a schlieren system, high-pressure air capability, and the availability of test section chokes. It could operate for two 8-hour shifts per day.

The tunnel became operational in 1953, was upgraded in 1980, and closed in 1996. Richard T. Whitcomb used the tunnel extensively in developing supercritical airfoils, winglets, and area-rule configurations. (The area-rule concept was developed in the 8-foot High-Speed Tunnel, the predecessor of the 8-foot Transonic Pressure Tunnel.)³²⁰ In addition to research concepts such as laminar flow control and hybrid laminar flow control, many past and present aircraft and

³¹⁸ Peter F. Jacobs, Senior Engineer, Research and Technology Directorate, NASA Langley Research Center, e-mail to author, August 9, 2006.

³¹⁹ Peñaranda and Freda, *Aeronautical Facilities Catalogue, Volume 1, Wind Tunnels*, p. 155.

³²⁰ Richard Whitcomb was a NACA and NASA engineer who developed the supercritical wing. An internationally known aerodynamicist, he received the Collier Trophy in 1954 for the year's greatest achievement in aviation.

spacecraft were tested in this tunnel. These included Saturn/Apollo, the Scout ELV, the Space Shuttle, C-141, C-5, YC-15 (C-17), B-1, F-8 Supercritical Wing, F-8 Digital Fly-By-Wire, T-2C Supercritical Wing, F-14, F-15, F-16, F-111, YF-17 (F/A-18), the Supersonic Transport, DC-10, Cessna Citation X, and the Gates Learjet.³²¹

The **14- by 22-foot Subsonic Tunnel** was an atmospheric, closed-return tunnel. Its test section was 14.5 feet (4.4 meters) high, 21.75 feet (6.6 meters) wide, and 50 feet (15.2 meters) long, and could reach a velocity of 348 feet per second (106 meters per second) with a dynamic pressure of 144 pounds per square foot (6.9 kilopascal). The flow in the closed-test-section configuration was relatively uniform, with a velocity fluctuation of 0.1 percent or less. When the test section was not in the fully closed configuration, the test-section velocity was lower and the turbulence level was higher. Airflow in the test section was produced by a 40-foot (12.2-meter)-diameter, nine-bladed fan. The tunnel had a set of flow control vanes to maintain close control of the speed for low-speed testing.

Models were typically mounted on carts for all tests, including ground-effects, high-AoA, rotorcraft, forced-oscillation, and semispan tests. The facility's six large model carts with varying capabilities supported a variety of tests. The model preparation area had several static test areas as well as a rotor test cell. The facility also had a support system with a pitch range of 32 degrees, a yaw range of 30 degrees, and a vertical traverse of 6 feet. The carts could be lowered 2 feet (0.6 meter) below the test section floor to accommodate acoustical treatment, a

³²¹ Peter F. Jacobs, Senior Engineer, Research and Technology Directorate, NASA Langley Research Center, e-mail to author, August 9, 2006.

microphone traverse system, or the third component of the laser velocimetry system. Figure 3-39 shows an HSR aircraft model mounted in the tunnel.



Figure 3-39. A high-speed research model in Langley's 14- by 22-foot subsonic tunnel, 25 August 1995 (NASA-LaRC photo EL-1998-00237).

The tunnel was constructed in 1970 to investigate the aerodynamics of V/STOL aircraft configurations.³²² The tunnel configurations included a fully closed test section and an open test section that was closed only on the floor. A boundary-layer removal system and moving-belt ground plane prevented formation of a floor boundary layer in the test section and provided a

³²² This tunnel was initially named the V/STOL Tunnel and later the 4- by 7-Meter Tunnel.

uniform vertical velocity distribution for ground-effects testing. The tunnel was also ideally suited for low-speed tests to determine high-lift stability and control, aerodynamic performance, rotorcraft acoustics, turboprop performance, motor sports, and basic wake and flowfield surveys. An extensive modification completed in 1984 improved the flow and expanded the tunnel's capabilities for both acoustic and rotorcraft tests. In 1999, the facility automation system and new model carts were added.³²³

The **30- by 60-foot Full-Scale Tunnel**, built in 1930, is NASA's oldest wind tunnel, and until 1945 it was the largest wind tunnel in the world. In 1985, it was named a National Historic Landmark. The overall tunnel was 434 feet (132 meters) long and 222 feet (67.7 meters) wide with a maximum height of 97 feet (30 meters). The actual test section was an open jet 30 feet (9.1 meters) high, 60 feet (18.3 meters) wide, and 56 feet (17.1 meters) long. The test section was modified several times to adapt to changing needs. During renovations in the 1960s and 1970s, the tunnel was equipped for free-flight dynamic-model tests and was used extensively for such tests. This testing technique, which was unique to this facility, involved flying 10–20 percent scale models controlled by remotely positioned pilots.³²⁴

The tunnel had shielded struts for the six-component scale balance used for large-scale model tests. A variety of smaller model mounts with internal balances were used. Auxiliary equipment consisted of compressed air supplies and 1,000- and 500-horsepower direct-current motors to supply power to the models. The facility accommodated models with a wingspan of up to 40 feet

³²³ "14 x 22 Foot Subsonic Tunnel," http://windtunnels.larc.nasa.gov/facilities_updated/aerodynamics/14X22.htm (accessed July 5, 2006).

³²⁴ "NASA Langley 30- by 60-Foot Tunnel To Be Closed," NASA Langley Research Center News Release 95-79, August 11, 1995, NASA History Division folder 11713, Historical Reference Collection, NASA Headquarters, Washington, DC.

(12.2 meters) and weight of 15,000 pounds (6,803 kilograms). It was powered by two four-bladed, 35.5-foot (10.8-meter)-diameter fans, each driven by a 4,000-horsepower electric motor.³²⁵ The support system allowed the model to be rotated about its center of gravity to AoAs up to 90 degrees and sideslip up to 60 degrees with minimal support interference. Force and moment data were acquired from an internally mounted strain-gage balance in all three axes. Figure 3-40 shows a period photo of the tunnel. Figure 3-41 shows an F/A-18E model undergoing testing in the tunnel. The purpose of the test was to investigate the aerodynamic static stability and control characteristics of the aircraft, particularly at high AoAs. This model was the last military aircraft configuration tested in this tunnel before NASA closed it on October 27, 1995.³²⁶

³²⁵ Peñaranda and Freda, *Aeronautical Facilities Catalog, Volume 1, Wind Tunnels*, p. 46.

³²⁶ “15% Model of F-18E in LaRC 30x60 Foot Tunnel,” <http://lisar.larc.nasa.gov/UTILS/info.cgi?id=EL-1996-00196> (accessed February 14, 2007). Also Keith Henry, NASA Office of Public Affairs, memo to NASA Headquarters, Attn: PMD/Bill Ingalls, September 25, 1995, NASA History Division folder 11713, Historical Reference Collection, NASA Headquarters, Washington, DC.

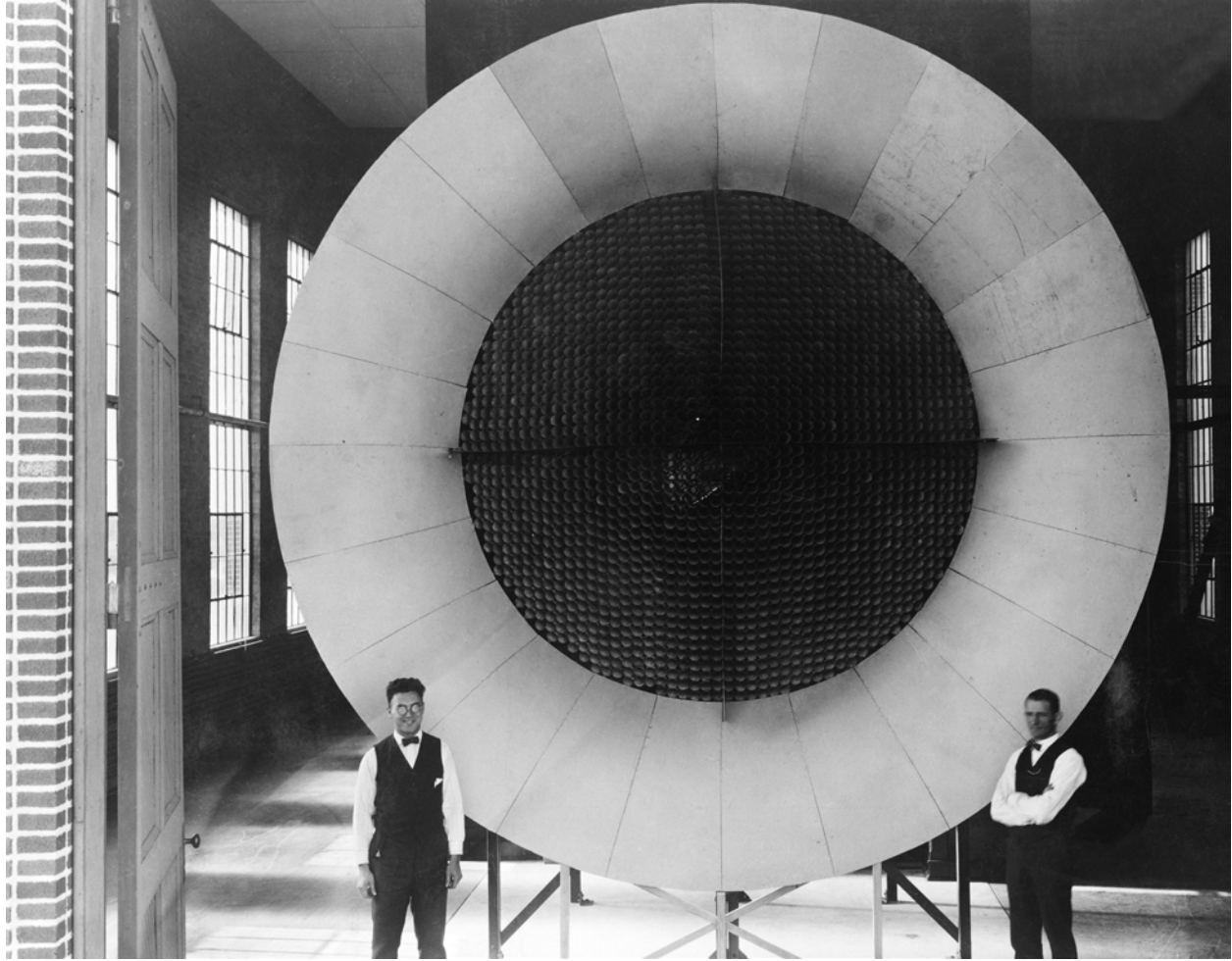

Figure 3-40. The honeycombed, screened center of this open-circuit air intake for Langley's first wind tunnel ensured a steady, nonturbulent flow of air. Two mechanics pose near the entrance end of the actual tunnel, where air was pulled into the test section through a honeycomb arrangement to smoothen the flow (NASA-HQ-GRIN photo GPN-2000-001296).



Figure 3-41. The photograph shows a 15 percent scale model of the F/A-18E undergoing low-speed testing in the Langley 30- by 60-foot tunnel (NASA-LaRC photo EL-1996-00196).

The **7- by 10-foot High-Speed Tunnel**, built in 1945, was a closed-circuit, single-return, continuous-flow, closed-throat tunnel that was used for static and dynamic studies of aerodynamic characteristics of aircraft and spacecraft models. Model mounts consisted of a low- to moderate-AoA performance sting system, a low- to high-AoA combined pitch-roll stability sting system, a sidewall turntable, forced oscillation apparatus, and other specialized systems. It could accommodate a model with a span of up to 5 feet (1.5 meters). The facility was powered by a 1,400-horsepower electric main-drive motor.³²⁷ It closed in 1994.³²⁸

³²⁷ Peñaranda and Freda, *Aeronautical Facilities Catalog, Volume 1, Wind Tunnels*, p. 79.

³²⁸ Peter F. Jacobs, Senior Engineer, Research and Technology Directorate, NASA Langley Research Center, e-mail to author, August 9, 2006. Also “Final Management Letter on Audit of Wind Tunnel Utilization,” Assignment

The **Low-Turbulence Pressure Tunnel (LTPT)**, built in 1940 and upgraded in 1981, was a single-return, closed-circuit tunnel that could be operated at stagnation pressures of 1 to 10 atmospheres. The rectangular test section was 3 feet (0.9 meter) wide by 7.5 feet (2.3 meters) high by 7.5 feet (2.3 meters) long, with a contraction ratio of 17.6:1. The chord length for a typical airfoil tested in the facility was approximately 2 feet (0.6 meter). Sidewall boundary-layer control was achieved by tangential blowing through tubes located on the model endplates or passive suction through porous endplates vented to the atmosphere. The tunnel also provided the capability to test 3-D models with six-component force balances mounted on a centerline strut. The LTPT had very low turbulence levels because of its large contraction ratio and fine-mesh antiturbulence screens.

This facility was used for 2- and 3-D testing of airfoils, including multielement, high-lift, basic research, and theory-validation studies. Its capabilities included 3-D model testing, a high-lift model support and balance system, a sidewall boundary-layer control system, and boundary-layer and wake-traverser systems. It exhibited excellent flow quality.³²⁹ Both the X-33 and X-34 were tested in this tunnel during 1997. Tests of the X-34 simulated the low-speed final approach to landing.³³⁰ Figure 3-42 shows an X-33 model undergoing testing in the tunnel.

Number A-03-007-00, Report Number IG-03-027, <http://oig.nasa.gov/audits/reports/FY03/pdfs/ig-03-027.pdf> (accessed August 15, 2006).

³²⁹ “Low Turbulence Pressure Tunnel,” http://windtunnels.larc.nasa.gov/facilities_updated/aerodynamics/low.htm (accessed July 5, 2006).

³³⁰ “NASA Langley Story Opportunities June 1997,” Langley News Release 97-43, June 1997, http://www.nasa.gov/centers/langley/news/releases/1997/Jun97/June_SO.html (accessed August 26, 2006).



Figure 3-42. The photo shows a metal model of the X-33 reusable launch vehicle (about 15 inches [38 centimeters] long by 15 inches wide) being tested for the Lockheed Martin Skunk Works in Langley's Low-Turbulence Pressure Tunnel. The subsonic tests were conducted at a speed of Mach 0.25. (NASA-LaRC photo EL-1997-00041).

The **National Transonic Facility** (NTF) was a cryogenic, fan-driven, closed-circuit, continuous-flow, high-pressure wind tunnel that provided test capabilities at very high Reynolds numbers, allowing accurate simulation of flight conditions for large aircraft. This accuracy helped researchers develop aircraft with improved efficiency, leading to reduced fuel usage and operating costs.³³¹ NTF tests supported stability and control, cruise performance, stall buffet onset, and configuration aerodynamics validation for both full- and half-span models. The

³³¹ *Aeronautics & Space Transportation Technology; Three Pillars for Success: Turning Goals Into Reality, Annual Progress Report 1997–1998*, p. 42.

customer's test objectives and priorities could be modeled using a computerized test process simulator to design the most efficient test plan strategy with respect to cost, duration, and consumables.

The test section had 12 slots and 14 reentry flaps in the ceiling and floor to prevent the near-sonic flow "choking" effect. Thermal insulation lined the interior of the pressure shell to ensure minimal energy consumption. The drive system consisted of a fan with variable inlet guide vanes for responsive Mach number control.

The tunnel had two modes of cooling. In the variable-temperature cryogenic mode, liquid nitrogen was sprayed into the circuit. The heat of vaporization and latent heat cooled the tunnel structure while removing fan heat. In this mode, the NTF tunnel provided full-scale flight Reynolds numbers without an increase in model size. In the ambient-temperature air mode, air was the test gas. Water flowed through the cooling coil to remove fan heat.³³²

The NTF was built in 1982 and completed its first year of operation in 1984.³³³ On January 18, the tunnel's 25 fan blades were damaged during a routine test due to the failure of a stainless-steel retaining band. Normal operations resumed after repairs were completed.³³⁴

³³² "National Transonic Facility," http://windtunnels.larc.nasa.gov/facilities_updated/aerodynamics/national.htm (accessed July 5, 2006).

³³³ "NASA's Wind Tunnels," Information Summaries, PMS 002 (LaRC), May 1988, NASA History Division folder 11713, Historical Reference Collection, NASA Headquarters, Washington, DC.

³³⁴ Edward H. Phillips, "NASA Prepares To Reopen Transonic Wind Tunnel After Major Fan Repairs," *Aviation Week & Space Technology* 131, no. 6 (August 7, 1989): 61, NASA History Division folder 11717, Historical Reference Collection, NASA Headquarters, Washington, DC.

The facility was upgraded in 1990 and 1997.³³⁵ In December 1997, the world's largest wind tunnel motor (100 megawatts) was installed to power the fan. The new fan-drive motor developed 135,000 horsepower, turning the fan blades to produce wind speeds of up to Mach 1.2. The motor was part of the \$23 million drive system built by Asea Brown Boveri in Switzerland and installed by Raytheon Constructors, Inc. It replaced an aging system that included three smaller motors, two gearboxes, and other equipment, and could provide 130,000 horsepower to the wind tunnel for only about 10 minutes and at one speed. The new motor developed the higher horsepower continuously through a speed range of 360–600 revolutions per minute, increasing the wind tunnel's operating envelope, reducing the time required to reach a test point, and simplifying the drive system.³³⁶

The **UPWT** was a closed-circuit, continuous-flow, variable-density supersonic wind tunnel with two test sections: one with a design Mach number range of 1.5–2.9, and one with a Mach number range of 2.3–4.6. The tunnel was equipped with asymmetric sliding-block-type nozzles to vary the ratio of nozzle throat to test section area, thus providing continuous variations in Mach number during operation. The low- and high-Mach number test sections were formed by the downstream contours of each nozzle. Test sections were nominally 4 by 4 feet (1.2 by 1.2 meters) in cross section by 7 feet (2.1 meters) in length.

³³⁵ Richard H. Truly, Letter to Congressman Bob Traxler, March 9, 1990, NASA History Division folder 11717, Historical Reference Collection, NASA Headquarters, Washington, DC. "NASA's Reynolds Wrap," *Aviation Week & Space Technology* 148, no. 3 (January 19, 1998): 8, NASA History Division folder 11717, Historical Reference Collection, NASA Headquarters, Washington, DC.

³³⁶ "Largest Wind Tunnel Motor of Its Kind in the World Goes On Line," Langley Research Center News Release 97-133, December 16, 1997, http://www.nasa.gov/centers/langley/news/releases/1997/Dec97/97_133.html (accessed August 23, 2006). Also *Aeronautics & Space Transportation Technology; Three Pillars for Success: Turning Goals Into Reality, Annual Progress Report 1997–1998*, p. 42.

The major elements of the facility were a 100,000-horsepower drive system, six centrifugal compressors that operated in varying combinations or modes, a dry air supply, an evacuating system, a cooling system, and interconnecting ducting that produced the desired run conditions through either of the two test sections. The tunnel duct circuit could be circumscribed by a rectangle 263 feet (80.1 meters) by 210 feet (64 meters). The methods used to support the models and probes varied depending on the test requirements. Increased model attitude was achieved by means of assorted angular couplings and offset stings. The basic model support mechanism was a horizontal wall-mounted strut assembly capable of forward and aft motion in the x-direction, a sting support with traverse and sideslip motion, an AoA mechanism that provided pitch motion, and a roll mechanism.³³⁷

Developmental tests of virtually every supersonic military airplane, missile, and spacecraft in the U.S. inventory that were planned to become operational, including most supersonic aircraft configurations from the National Supersonic Transport program, the Space Shuttle program, and NASP, were performed in this facility. Other vehicles and components tested included the HSR aircraft, the X-33 and X-34, and the Experimental Crew Return Vehicle (X-38).³³⁸ Figure 3-43 shows an X-38 model being tested in the tunnel.

The tunnel was built in 1954 and upgraded in 1979.³³⁹

³³⁷ “The Unitary Plan Wind Tunnel, NASA Langley Research Center” <http://windtunnels.larc.nasa.gov/facilities/aerodynamics/unitary.cfm?field=5&id=2&fac=1> (accessed March 6, 2007).

³³⁸ “Unitary Plan Wind Tunnel,” http://windtunnels.larc.nasa.gov/facilities_updated/aerodynamics/unitary.htm (accessed July 5, 2006).

³³⁹ Peñaranda and Freda, *Aeronautical Facilities Catalogue, Volume 1, Wind Tunnels*, p. 227.

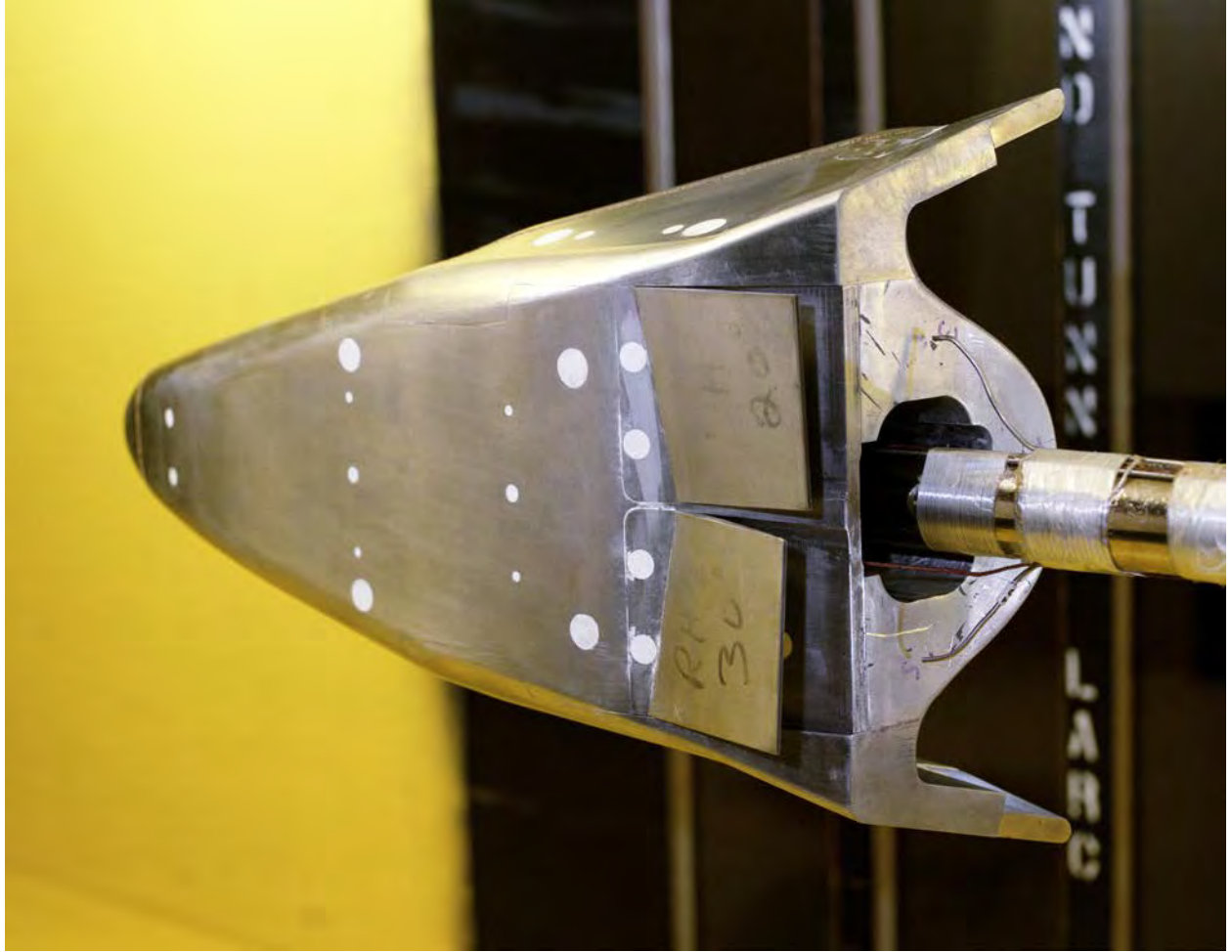

Figure 3-43. This photo shows a bottom view of the X-38 model with the docking ring mounted in test section 1 of the Unitary Plan Wind Tunnel (NASA photo EL-1998-00194).

The **16-foot Transonic Dynamics Tunnel (TDT)** was a national facility that was used to identify, understand, and solve aeroelastic problems.³⁴⁰ The closed-circuit, single-return, continuous-flow, slotted-throat tunnel provided variable-density pressure, free-flight capability, and low dynamic pressure per unit Reynolds number. It was dedicated to aeroelasticity research and was the country's only facility for performing flutter wind tunnel tests. It was specially configured for flutter tests of fixed-wing models, and the facility was used to validate aircraft designs with respect to the limits of allowable flutter motion. The flutter test results provided valuable information to designers and enabled the development of structurally sound, lighter-weight, more efficient, and safer aircraft. The tunnel could be operated at stagnation pressures from near vacuum (0.025 atmosphere) to atmospheric pressure and at dynamic pressures from near vacuum (0.25 atms) to atmospheric and at dynamic pressures up to 330 pounds per square foot (psf) (15.8 kilopascals) in air and 550 psf (26.3 kilopascals) in R-134a. In 1998, the wind tunnel completed the transition from using a greenhouse gas (R-12 Freon) to employing a more environmentally friendly gas (R-134a Freon).³⁴¹ Figure 3-44 shows an engineering technician in the TDT.

³⁴⁰ "Transonic Dynamics Tunnel," NASA Langley Research Center, Wind Tunnel Enterprise, http://windtunnels.larc.nasa.gov/facilities_updated/aeroelasticity/transonic.htm (accessed July 5, 2006).

³⁴¹ *Aeronautics & Space Transportation Technology, Three Pillars for Success: Turning Goals Into Reality, Annual Progress Report 1997–1998*, pp. 42–43. Also Peñaranda and Freda, *Aeronautical Facilities Catalogue, Volume 1, Wind Tunnels*, p. 147.

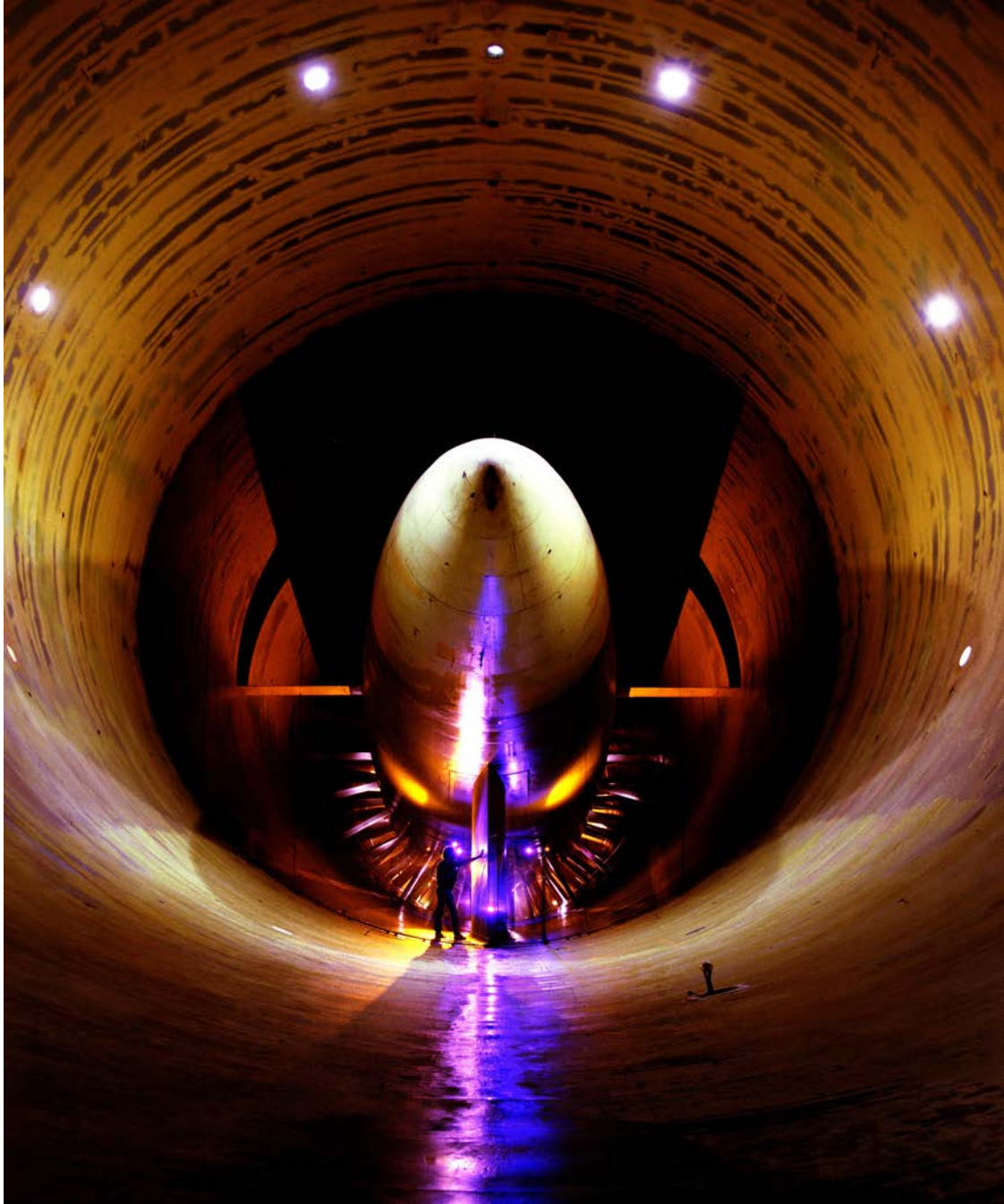

Figure 3-44. An engineering technician inspects the rear of an engine nacelle after a test run in the Transonic Dynamics Tunnel, 1992 (NASA-LaRC photo EL-1996-00009).

The **16-foot Transonic Tunnel** was an atmospheric, closed-circuit tunnel that combined wind tunnel conditions for inlet, nozzle, and aerodynamic tests across the transonic speed range under atmospheric conditions. The octagonal test section was 15.5 feet (4.7 meters) across the flats. The twin 34-foot (10.4-meter)-diameter drive fans formed a two-stage axial flow compressor with counter-rotating blades and no stator. It achieved boundary-layer control during transonic operation with a 35,000-horsepower axial flow compressor that could remove up to 4.5 percent of the tunnel flow from the plenum surrounding the test section. Photographic and video coverage of the test section could be achieved from the sidewalls and ceiling. Video images of the model could record key tunnel parameters superimposed on the screen.

Active since November 1941 and upgraded in 1975, 1985, and 1990, the tunnel was used for force, moment, pressure, and propulsion-airframe integration studies. Model mounts consisted of sting, sting-strut, and fixed-strut arrangements. Propulsion simulation studies could be performed using dry, cold, high-pressure air. The test-section length was 22 feet (6.7 meters) for speeds up to Mach 1.0, and 8 feet for speeds above Mach 1.0. The tunnel was equipped with an air exchanger with adjustable intake and exit vanes to provide some temperature control. It had a large cone fairing that helped reduce disturbances in airflow around corners. In addition, guide vanes behind the cone, which formed an ellipse, cut across each cylindrical tube at a 45-degree angle. Similar sets of vanes at the three other corners of the wind tunnel turned the air uniformly as it rushed through the 1,000-foot (304.8-meter) racetrack-like enclosed tube.³⁴² This facility had a main drive of 60,000 horsepower.

³⁴² “NASA Langley’s 16 Foot Transonic Wind Tunnel Cone Fairing,” <http://nix.ksc.nasa.gov/info:jsessionid=4n30jkmib05t?id=EL-1996-00003&orgid=1> (accessed February 14, 2007).

Program activities focused on propulsion integration characteristics for advanced aircraft, including inlet and nozzle integration for fighter aircraft, and pylon and nacelle integration for turbofan and turboprop transport aircraft.³⁴³ The tunnel supported most major military programs in their developmental stages and in ongoing propulsion integration research. It was also used to perform extensive tests for the Space Shuttle, X-33, and experimental programs, such as Highly Maneuverable Aircraft Technology (HiMAT). The tunnel closed in September 2004.³⁴⁴

Figure 3-45 shows the tunnel cone fairing.



Figure 3-45. This photo shows a technician preparing to unlatch the door built into one of the guide vanes of the 16-Foot Transonic Wind Tunnel (NASA-LaRC photo EL-1996-0003).

³⁴³ Peñaranda and Freda, *Aeronautical Facilities Catalog, Volume 1, Wind Tunnels*, p. 148.

³⁴⁴ “Media Invited To Witness Historic Tunnel’s Final Test,” Langley Research Center News Release 04-060, September 20, 2004.

The **20-foot Vertical Spin Tunnel (VST)**, which became operational in March 1941 and was upgraded in 1984, was a closed-throat, annular-return wind tunnel that operated under atmospheric conditions. The 12-sided test section was 20 feet (6.1 meters) across by 25 feet (7.6 meters) tall. The test-section velocity could be varied from 0 to approximately 85 feet per second (26 meters per second). The test-section airflow was produced by a three-bladed, fixed-pitch fan powered by a 400-horsepower direct-current motor equipped with a control system designed to allow rapid changes in fan speed, which resulted in maximum flow accelerations in the test section of -25 ft/sec^2 to 15 ft/sec^2 (-7.6 m/sec^2 to 4.6 m/sec^2). The rotary balance arm suspended a model in the air stream at AoAs of 0–90 degrees and angles of sideslip of ± 45 degrees while maintaining the relative position of the model reference center. Both top- and aft-mount stings were available. The rig could be rotated in both the clockwise or counterclockwise directions at up to 60 revolutions per minute. The system could support models weighing up to 15 pounds (6.8 kilograms).³⁴⁵

Dynamically scaled, free-flying models were used to investigate large-angle, high-rate phenomena. Aircraft models could be tested for spinning, tumbling, and other out-of-control situations. Spacecraft models could be used for free-fall and dynamic stability characteristics.

Test images were documented on high-resolution color video.³⁴⁶

The **12-foot Low-Speed Tunnel** was an atmospheric-pressure, open-circuit tunnel enclosed in a 60-foot (18.3-meter)-diameter sphere. The test section was octagonal with a width and height of

³⁴⁵ “20-Foot Vertical Spin Tunnel,” NASA Langley Research Center, Wind Tunnel Enterprise, http://windtunnels.larc.nasa.gov/facilities_updated/flight_dynamics/20foot.htm (accessed July 5, 2006). Also Peñaranda and Freda, *Aeronautical Facilities Catalogue, Volume 1, Wind Tunnels*, p. 112.

³⁴⁶ “20-Foot Vertical Spin Tunnel,” NASA Langley Research Center, Wind Tunnel Enterprise, http://windtunnels.larc.nasa.gov/facilities_updated/flight_dynamics/20foot.htm (accessed July 5, 2006).

12 feet (3.7 meters) and a length of 15 feet (4.6 meters). Each octagonal side measured 5 feet (1.5 meters). The maximum operating pressure was 7 pounds per square foot (34.2 kilograms per square meter). The longitudinal centerline flow in the test section had a turbulence level of about 0.6 percent. Test-section airflow was produced by a 15.8-foot (4.8-meter)-diameter, six-bladed drive fan powered by a 280-horsepower, 600-volt, 600-revolutions-per-minute, direct-current motor. The motor was controlled by a 500-horsepower alternating-current motor, which drove a field-controlled generator. This tunnel could support several types of flow-visualization techniques, including tufts (yarn or Mylar), propylene glycol smoke, and a laser light sheet.

The work conducted in this tunnel generally involved exploratory research to screen and refine advanced aerospace technologies and vehicle concepts. Much of the research focused on stability and control characteristics, and on understanding the steady and time-dependent aerodynamics responsible for those characteristics. Because the aerodynamic loads were low, many tests could be conducted with relatively simple and inexpensive models made of fiberglass, foam, and wood.³⁴⁷

The **20-Inch Supersonic Wind Tunnel** was a blowdown facility powered by the high-pressure-air and low-vacuum systems of the Gas Dynamics Facility. Using these resources, the tunnel could operate with stagnation pressures of 0.5 psia (absolute pressure) up to 130 psia across the Mach number range of 2.85–5.0. Above the Mach number range of 1.6–2.85, the maximum pressure was limited by the system’s maximum mass flow rate of 280 pounds-mass (127 kilograms) per second.

³⁴⁷ “12-Foot Low-Speed Tunnel,” NASA Langley Research Center, Wind Tunnel Enterprise, http://windtunnels.larc.nasa.gov/facilities_updated/flight_dynamics/12foot.htm (accessed July 5, 2006).

The test section of the tunnel was 20 inches (50.8 centimeters) high and 18 inches (45.7 centimeters) wide, and had optical access from three directions. Test times were typically vacuum-limited to approximately 300 seconds, but varied with the test conditions. Operations with recovery pressures above atmosphere were operated through a muffler and were limited to a total mass usage of 250,000 pounds-mass (113,398 kilograms) or less. In subsonic operation of the facility, the unique ability to measure airfoil characteristics and drag was demonstrated over the subsonic/transonic Mach range of 0.35–0.75 to simulate either high-altitude or Martian atmospheric flight, and was effective for evaluating boundary-layer tripping in this regime.³⁴⁸

The **Supersonic Low-Disturbance Tunnel (SLDT)** provided a low-disturbance, free-stream environment for high-speed transition research. This blowdown tunnel used dry air that had been filtered to exclude particles ≥ 1 micrometer in size. The tunnel exhausted to vacuum spheres or the atmosphere and provided typical run times of 30–45 minutes. Stagnation pressures of 5–175 psia could be achieved at a free-stream Mach number of 3.5. The two-dimensional nozzle was approximately 15 inches (38.1 centimeters) long and had an exit size of 10 inches (25.4 centimeters) wide by 6 inches (15.2 centimeters) high. It was configured as an open jet that exhausted into a straight pipe diffuser.³⁴⁹

The **8-foot High-Temperature Tunnel** was a combustion-heated hypersonic blowdown-to-atmosphere wind tunnel that could be used to simulate flight enthalpy for Mach numbers of 4, 5, and 7 at altitudes of 50,000–120,000 feet (15,240–36,576 meters). The open-jet test section was

³⁴⁸ “20-Inch Supersonic Wind Tunnel,”

http://windtunnels.larc.nasa.gov/facilities_updated/fluid_dynamics/20inch_supersonic2.htm (accessed July 5, 2006).

³⁴⁹ “Supersonic Low Disturbance Tunnel,”

http://windtunnels.larc.nasa.gov/facilities_updated/fluid_dynamics/supersonic.htm (accessed July 5, 2006).

8 feet (2.4 meters) in diameter and 12 feet (3.7 meters) long. The test section could accommodate very large models, air-breathing hypersonic propulsion systems, and structural and TPS components. Stable wind tunnel test conditions could be provided for up to about 60 seconds. Additional simulation capabilities were provided by a radiant heater system that could be used to simulate ascent or entry heating profiles. The combustion product of the air and methane that were burned in a pressurized combustion chamber produced the high-energy test medium. Oxygen was added for air-breathing propulsion tests. The hydraulic-actuated model insertion system could support (1) an arc sector pitch strut assembly that provided ± 20 -degree AoAs for models weighing up to 10,000 pounds (4,536 kilograms) and (2) a force measurement system used for pedestal-mounted propulsion models weighing up to 40,000 pounds (18,144 kilograms). Electrical power, cooling water, hydraulic lines, high-pressure air, nitrogen, and other gases were available for all models.³⁵⁰

Tunnel construction began in March 1959 and was completed in early 1964. The first tunnel run took place in August 1965. Full operation of all systems was demonstrated in 1973. The tunnel supported the Space Shuttle program and the Mach 8 X-24C program. It was used for basic research on TPS materials and seals, gap heating, and shock interaction heating. In the mid-1980s, the tunnel was modified to support air-breathing propulsion system tests. This modification included a liquid-oxygen system, a gaseous-hydrogen system, and alternate Mach number capability. Upgrades beginning in 1988 were made to the facility controls, data-acquisition system, high-pressure air system, gaseous-nitrogen purge system, model ignition system, and thrust measurement capability. Checkout of the integrated systems began in 1990,

³⁵⁰ “8-Foot High Temperature Tunnel,” http://windtunnels.larc.nasa.gov/facilities_updated/hypersonic/8ft.htm (accessed July 5, 2006).

and the first successful hydrogen-fueled test of the NASP concept demonstration engine took place in June 1994. After the NASP program ended, testing began in support of the X-33 program. Further modifications to the tunnel were made in the mid-1990s, and testing of the X-33 TPS began in October 1998.³⁵¹

The **Arc-Heated Scramjet Test Facility (AHSTF)** was used to test component integration models of airframe integrated scramjet engines under conditions experienced at flight Mach numbers of 4.7–8. It provided a true-temperature, true-velocity flow environment for testing scramjet engine models. Typical models tested in this facility included the inlet, isolator, combustor, and a significant portion of the nozzle, and were hydrogen- and silane-fueled. Typical model sizes were 9.5 by 7.5 inches (24.1 by 19 centimeters) in cross section by 5 feet (1.5 meters) long. The results were used to assess scramjet performance and optimize component designs and fueling schemes. The facility was remotely operated with controls in a room adjacent to the facility's arc heater and test section. The flow at the exit of the 11- by 11-inch (28- by 28-centimeter) facility nozzle into the 4-foot (1.2-meter)-diameter test section simulated the flow entering a scramjet engine module in flight that had been processed by the forebody shock of the vehicle. The total enthalpy of the flight condition was achieved by electrically heating the air with a Linde arc heater. The facility operated for scramjet testing beginning in 1976.³⁵²

³⁵¹ Jeffrey S. Hodge and Stephen F. Harvin, "The NASA Langley Research Center 8-ft High Temperature Tunnel," in Lu and Marren, ed., *Advanced Hypersonic Test Facilities*, pp. 406–407. Also "NASA-Langley Story Opportunities—November," Langley News Release 98-091, November 4, 1998, http://www.nasa.gov/centers/langley/news/releases/1998/Nov98/Nov_SO.html (accessed August 28, 2006).

³⁵² "Arc-Heated Scramjet Test Facility," http://windtunnels.larc.nasa.gov/facilities_updated/hypersonic/arc-heated.htm (accessed July 5, 2006). Also Peñaranda and Freda, *Aeronautical Facilities Catalogue, Volume 1, Wind Tunnels*, p. 280.

The **Combustion Heated Scramjet Test Facility (CHSTF)** was used to test complete (inlet, combustor, and partial nozzle) subscale scramjet component-integration models in flows with stagnation enthalpies duplicating that of flight at Mach numbers from 3.5 to 6. The facility began operating in 1978.

The facility was located in a 16- by 16- by 52-foot (4.9- by 4.9- by 15.8-meter) test cell with forced air ventilation through the entire cell. It was adjacent to the Direct-Connect Supersonic Combustion Test Facility (DCSCTF), and both facilities shared the gas and vacuum systems and portions of the data-acquisition system. Test air was supplied from a high-pressure bottle field and was regulated to 550 psia (nominal) before it entered the test cell. Gaseous hydrogen and oxygen were both supplied from tube trailers at a maximum pressure of 2,400 psia and regulated to 720 psia before they entered the test cell. Purge nitrogen was also supplied from a tube trailer at a maximum pressure of 2,400 psia with the pressure regulated to 230 psia. Vacuum for altitude simulation was provided by a 70-foot (21-meter)-diameter vacuum sphere and steam ejector system.

The facility used a hydrogen, air, and oxygen heater to obtain the flight stagnation enthalpy required for engine testing. Oxygen was replenished in the heater to obtain a test gas with the oxygen mole fraction of air (0.2095). The facility could be operated with either a Mach 3.5 or 4.7 nozzle. Both nozzles had square cross sections and were contoured to exit dimensions of 13.26 by 13.26 inches (33.68 by 33.68 centimeters). The nozzle flow exhausted as a free jet into the test section, which was 42 inches (107 centimeters) high by 30 inches (84 centimeters) wide by 96 inches (244 centimeters) long. The free jet passed through and around the engine model and

then into a catch cone diffuser. The flow was typically exhausted into a 70-foot (21-meter)-diameter vacuum sphere.

Either gaseous hydrogen or gaseous ethylene (both at ambient temperature) could be used as the primary fuel in the scramjet engines tested in the facility. A 20-percent silane, 80-percent hydrogen mixture (by volume) was available for use in the scramjet model as an igniter/pilot gas to aid in combustion of the primary fuel.³⁵³

The **Direct-Connect Supersonic Combustion Test Facility (DCSCTF)** was used to test ramjet and scramjet combustor models in flows with stagnation enthalpies duplicating that of flight at Mach numbers between 4 and 7.5. Results of the tests were typically used to assess the mixing, ignition, flameholding, and combustion characteristics of the combustor models.

The facility was located in a 16- by 16- by 52-foot (4.9- by 4.9- by 15.9-meter) test cell with 2-foot (0.6-meter)-thick steel-reinforced concrete walls and forced-air ventilation. Test air was supplied from a high-pressure bottle field and was regulated to 550 psia (nominal) before it entered the test cell. Gaseous hydrogen was supplied from 60,000-cubic-foot (1,699-cubic-meter) tube trailers at a maximum pressure of 2,400 psia and was regulated to 720 psia. Oxygen was supplied from trailers at a maximum pressure of 2,400 psia and was regulated to 720 psia before it entered the test cell. A 20-percent silane and 80-percent hydrogen mixture (by volume) was supplied from K-size cylinders for use as an igniter of the primary fuel in the combustor

³⁵³ “Combustion-Heated Scramjet Test Facility,” http://windtunnels.larc.nasa.gov/facilities_updated/hypersonic/combustion.htm (accessed July 5, 2006).

models. Purge nitrogen was also supplied from a tube trailer at a maximum pressure of 2,400 psia with the pressure regulated to 230 psia.

The high stagnation enthalpy necessary to simulate flight was achieved through hydrogen-air combustion with oxygen replenishment to obtain a test gas with the same oxygen mole fraction as atmospheric air (0.2095). The flow at the exit of the facility nozzle simulated the flow entering the combustor of a ramjet or a scramjet in flight. The facility normally operated at heater stagnation pressures between 115 and 500 psia, and at heater stagnation temperatures between 1,600°R (616°C) and 3,800°R (1,838°C).³⁵⁴ Test gas mass flow rates ranged from 1 to 7 pound-mass (0.45–3.2 kilograms) per second.³⁵⁵

The **HYpersonic PULSE (HYPULSE)** wind tunnel was operated by the GASL Division of Allied Aerospace Industries, Inc., for NASA Langley Research Center. It used wave processes to heat, compress, and accelerate air to the thermodynamic and kinematic conditions encountered in terrestrial atmospheric flight from Mach 5 to orbital speed, Mach 25. Gases simulating other planetary atmospheres could also be used. Recent uses included studies of scramjets in support of hypersonic air-breathing propulsion at flight Mach 7 to Mach 15. Major components of the tunnel included a 6.5-inch (16.3-centimeter)-diameter, 20,000 pounds per square inch (psi) driver; 6-inch (15-centimeter)-diameter, 5,500 psi shock tubes; a 7-foot (2.1-meter)-diameter, 19-foot (5.8-meter)-long test section; and a 4-foot (1.2-meter)-diameter, 35-foot (10.7-meter)-long

³⁵⁴ The Rankine temperature scale is a temperature scale with the degree-interval of the Fahrenheit temperature scale and the zero point at absolute zero. The ice point is thus 491.69° Rankine and the boiling point of water is 671.69° Rankine. *NASA Aerospace and Science Dictionary*, <http://www.hq.nasa.gov/office/hqlibrary/aerospacedictionary/> (accessed August 22, 2006).

³⁵⁵ “Direct Connect Supersonic Combustion Test Facility,” http://windtunnels.larc.nasa.gov/facilities_updated/hypersonic/direct.htm (accessed July 5, 2006).

dump tank. The overall length of the facility was 150 feet (46 meters). The tunnel hardware could be configured as a reflected-shock tunnel for simulation in the flight Mach 5 to Mach 10 range, or as a shock-expansion tunnel for flight Mach 12 to Mach 25 operation. For propulsion tests, fuel was supplied to the engine hardware from Ludweig tubes located within the dump tank. The four Ludweig tubes could provide gaseous hydrogen or other fuel at room temperature for scramjet tests, or hydrogen and oxygen separately for rocket motor simulations.³⁵⁶

The **Langley Aerothermodynamics Laboratory (LAL)** was a collection of four hypersonic wind tunnels that were used for basic fundamental flow physics research, aerodynamic performance measurements, and aeroheating assessment, optimization, and benchmarking (when combined with computational fluid dynamics) of advanced space transportation vehicles. The LAL facilities were relatively small and economical to operate, and hence were ideally suited for such fast-paced studies. Collectively, they provided a wide range of Mach numbers, unit Reynolds numbers, and normal shock density ratios.

The LAL facilities were designed and constructed in the late 1950s and early 1960s. These facilities have contributed to most major hypersonic vehicle programs, including the Apollo, Viking, Space Shuttle Orbiter, NASP, Pegasus XL, DC-X, X-33, X-34, X-38/Experimental Crew Return Vehicle, RLV, and X-43/Hyper-X programs.

³⁵⁶ “HYPULSE Shock Tunnel,” http://windtunnels.larc.nasa.gov/facilities_updated/hypersonic/HYPULSE.htm (accessed July 5, 2006).

The LAL consisted of: (1) the 15-Inch Mach 6 High-Temperature Tunnel, (2) the 20-Inch Mach 6 CF4 Tunnel, (3) the 20-Inch Mach 6 Tunnel, and (4) the 31-Inch Mach 10 Tunnel.³⁵⁷

Figure 3-46 shows preparation for testing in the Mach 6 CF4 tunnel. See table 3-40 above for characteristics of these tunnels.



Figure 3-46. A NASA research engineer prepares a Rockwell X-33 model for testing in the Mach 6 CF4 wind tunnel, 1995 (NASA-LaRC photo EL-1996-00160).

Acoustic Wind Tunnel Facilities

The **Anechoic Noise Research Facility (ANRF)** was an open-circuit, high-pressure air-driven, anechoic wind tunnel. The anechoic chamber measured 27.5 feet (8.4 meters) by 27 feet (8.2

³⁵⁷ “Langley Aerothermodynamics Laboratory (LAL),” http://windtunnels.larc.nasa.gov/facilities_updated/aerothermodynamics/31%22M10.htm (accessed July 5, 2006).

meters) by 24 feet (7.3 meters) from the tips of the acoustic wedges. The acoustic wedges, which covered the walls, floor, and ceiling, were 3 feet (0.9 meter) deep and provided 99 percent sound absorption at frequencies above 125 hertz. The ANRF was used for in-house program-supported research, joint research projects with industry partners, and graduate research program support.

The projects supported by the facility included the following:

- Evaluation of active, adaptive noise control to reduce broadband fan noise in ducts
- Evaluation of inlet noise reduction by the Blended Wing Body airframe
- Development of phased-array microphone technology to determine the mode structure of fan noise in ducts
- Inlet boundary-layer modulation to reduce rotor/stator interaction noise generation
- Advanced microphone array techniques for nonintrusive fan duct radiated noise analysis
- In-duct error sensor for global control of fan-radiated tone noise
- Preliminary evaluation of noise generation by impingement of rotor wake on a stator
- Reduction of inflow distortion in a scarf inlet using circulation control
- Use of Herschel-Quincke tube technology to reduce fan noise in ducts
- Fundamental noise-shielding evaluation for an engine-over-wing configuration
- Acquisition and analysis of acoustic test data from field experiments on full-scale engines on engine manufacturer's test stands

The **Langley Flow Impedance Test Facility (FITF)** was used to characterize the acoustic performance of full-scale acoustic liner materials for use in commercial aircraft engine nacelles.

The facility contained four major measurement apparatuses: (1) a raylometer, (2) a pulse impedance tube, (3) a normal incidence impedance tube, and (4) a grazing flow impedance tube.

The raylometer was used to measure the direct current flow resistance of acoustic absorbers. This fully automated device was capable of measurements over velocities of 0.001–5 meters (0.003–16.4 feet) per second, which were well beyond the range of raylometers commonly used in industry.

The pulse impedance tube used a time-domain approach to determine the acoustic characteristics of test samples at high sound pressure levels. This was achieved via a high-intensity sound source capable of producing pulses up to 170 decibels.

In the 2 by 2-inch (5 by 5-centimeter) normal incidence impedance tube, sound waves were impinged onto the surface of acoustic absorbers mounted onto the end of the apparatus. This sound was reflected from the sample, setting up standing wave patterns that were used to determine the absorptive qualities of the absorbers.

The grazing flow impedance tube, a 2 by 2-inch (5 by 5-centimeter) cross-section wind tunnel, was used to measure the acoustic properties of sound-absorptive materials in the presence of mean flow up to Mach 0.5. The normal incidence and grazing incidence tubes were typically operated over a frequency of 500–3,000 hertz with incident sound pressure levels from 100 to 160 decibels (the maximum level was test-specimen-dependent).³⁵⁸

³⁵⁸ “Flow Impedance Test Facility; Langley Research Center,” http://wte.larc.nasa.gov/facilities_updated/acoustics/fitf.htm (accessed March 6, 2007).

The **Jet Noise Lab** was used to plan and conduct research aimed at understanding, predicting, and controlling the noise of fixed-wing and rotary-wing aircraft. The scope of research included fundamental theoretical, analytical, and experimental research, as well as applied research in support of the High-Speed Research, Advanced Subsonic Technology, and Short Haul (Civil Transport) programs. Research emphasized the fluid mechanics and acoustics of jets, nacelle and fan aeroacoustics, rotorcraft and propeller noise, airframe noise, and atmospheric sound propagation. The objectives of the research were to understand the noise-generation process, develop methods for predicting acoustics and flowfields and their interactions, and identify and demonstrate noise reduction and control techniques.

The **Quiet Flow Facility** was an anechoic open-jet facility designed specifically for acoustic testing. The anechoic chamber surrounding the free jet was 9.1 meters (29.5 feet) by 6.1 meters (20 feet) by 7.6 meters (24.9 feet) high as measured from acoustic wedge tip to wedge tip. The free jet exhausted vertically through an acoustically treated exhaust port in the chamber ceiling. Flow-circuit turbulence screens and turning vanes were included to ensure low-turbulence airflow. The entire anechoic room was mounted on springs to isolate it structurally from the rest of the building to minimize transmission of structure-borne noise into the facility.³⁵⁹

The **Structural Acoustic Loads and Transmission (SALT)** facility consisted of an anechoic chamber, a reverberation chamber, and a transmission loss (TL) window. The anechoic chamber was 4.57 meters (15 feet) high, 7.65 meters (25 feet) wide, and 9.63 meters (31.6 feet) long, as measured from wedge tip to wedge tip, for a volume of 337 cubic meters (11,901 cubic feet).

³⁵⁹ "Quiet Flow Facility," http://windtunnels.larc.nasa.gov/facilities_updated/acoustics/quiet.htm (accessed August 8, 2006).

The double walls of the chamber (concrete and sheet rock) were designed to provide 54 decibels of sound attenuation at 125 hertz. Two 0.21-meter (0.6-foot)-thick, 1.65-meter (1.4-foot)-wide, and 3.13-meter (10.3-foot)-high swinging door assemblies with reinforced metal facings and interior absorptive materials provided access to the room. More than 4,850 open-cell polyurethane acoustic wedges covered the walls, ceiling, and floor in the anechoic chamber. The 0.914-meter (3-foot)-tall wedges had a 0.3048 by 0.3048 by 0.3048-meter (1 by 1 by 1-foot) base with a 0.610-meter (2-foot)-long tapered section for a weight of 1.69 kilograms (3.7 pounds) per specimen. Absorption coefficients ranged from 1.19 at 100 hertz to 2.80 at 5,000 hertz. The movable partition in front of the TL window was covered with an arrangement of 90 wedges. A hemi-anechoic environment could be obtained by removing the wedges from the floor of the anechoic chamber. The anechoic and hemi-anechoic chambers provided a free-field or partly free-field environment for sound power, sound pressure level, sound intensity, and directivity measurements of acoustic sources.

The 278-cubic-meter (9,817-cubic-foot) reverberation chamber was structurally isolated from the rest of the building. It measured approximately 4.5 meters (14.8 feet) by 6.5 meters (21.3 feet) by 9.5 meters (31.2 feet). The chamber walls and ceiling were splayed to diminish the effects of standing waves between opposite surfaces, and were separated by a 30-inch (76-centimeter) air gap from the surrounding 0.46-meter (1.5-foot)-thick concrete building walls. The total surface area of the walls, floor, and ceiling was approximately 290 square meters (3,122 square feet).

The TL window accommodated 1.41- by 1.41-meter (4.62- by 4.62-foot) test structures to allow for sound radiation and sound TL measurements. The TL window frame was installed on four

isolators in the wall of the reverberation chamber. To prevent structural vibrations from transmitting into the anechoic chamber, the reverberation and anechoic chambers were connected only by a rubber slab. Concrete supports with steel fairings and multiple layers of lead provided high noise attenuation.³⁶⁰

The **Langley Thermal Acoustic Fatigue Apparatus**, a progressive wave tube test facility, was used to test structures for dynamic response and sonic fatigue due to combined, high-intensity thermal acoustic environments. Before 1994, it supported development of the TPS for the Space Shuttle, NASP, and various generic hypersonic vehicle structures. Extensive modifications to the sound-generation system and the wave tube itself were made in 1994 and 1995 to improve the facility's performance. After these improvements were completed, it was used for sonic fatigue studies of the wing strake subcomponents on the HSCT.³⁶¹

The **Jet Exit Test Facility** was an indoor engine/nozzle test stand that combined multiple-flow air propulsion simulation with high-pressure and high-mass flow capabilities. It had a flow rate of 0.1–40 pounds mass (0.45–18.1 kilograms) per second and a thrust capacity of 1,200 pounds-force (5.3 kilonewtons). The facility was originally designed for single-flow nozzle testing and played a significant role in developing advanced aircraft thrust-vectoring propulsion nozzle concepts during the period of 1970–1990. It was redesigned in the early 1990s to add the second independently controlled air system. Typical test projects during the last decade included the following:

³⁶⁰ “Structural Acoustic Loads and Transmission (SALT) Facility,” http://windtunnels.larc.nasa.gov/facilities_updated/acoustics/salt.htm (accessed August 8, 2006).

³⁶¹ “Thermal Acoustic Fatigue Apparatus,” http://windtunnels.larc.nasa.gov/facilities_updated/acoustics/tafa.htm (accessed August 8, 2006).

- Performance evaluations of advanced multidimensional exhaust systems
- Calibration of nozzles and components for other applications (such as wind tunnel experiments)
- Flow testing of full-scale fan-engine sectors to evaluate new actuation-system concepts
- Performance testing of multiple-flow fluidic injection concepts (with core flow and two or more independently-controlled secondary flows) for thrust vectoring, plume control, or throat-area control
- Application of suction as a secondary feature for thrust vectoring and performance augmentation
- High-volume, dual-flow propulsion simulations, such as ejector nozzles, and combined core and fan exhaust configurations with and without thrust reversing³⁶²

Lewis Research Center

The **Abe Silverstein 10- by 10-foot Supersonic Wind Tunnel** was the largest and fastest wind tunnel at Lewis Research Center.³⁶³ The 10- by 10- by 40-foot (3.048- by 3.048- by 12.2-meter) test section could accommodate large-scale models, full-scale engines, and aircraft components. The tunnel was specifically designed to test supersonic propulsion components (such as inlets and nozzles), propulsion-system integration, and full-scale jet and rocket engines. It could operate as a closed-loop system (aerodynamic cycle) or an open-loop system (propulsion cycle),

³⁶² “Facility Type: Nozzle Test Stand,” <http://windtunnels.larc.nasa.gov/nozzle.htm>. Also “Jet Exit Test Facility,” http://windtunnels.larc.nasa.gov/facilities_updated/nozzle/jet_exit.htm (both accessed July 5, 2006).

³⁶³ The 10 by 10-foot Supersonic Wind Tunnel was renamed for Abe Silverstein in 1994 in recognition of his accomplishments. He had been responsible for the Mercury program and all of NASA’s uncrewed satellite programs for the first three years of the Agency. In 1956, under his leadership and that of Eugene Waslewski, the tunnel was brought on line.

reaching test-section speeds of Mach 2.0–3.5 and very low speeds from 0 to Mach 0.4. Gust and Mach plates were sometimes installed to expand local Mach number conditions between Mach 1.5 and 4.1. It also allowed continuous operation across the entire speed and altitude regime, resulting in greater flexibility and productivity during testing.

The propulsion cycle mode was used for models that introduced contaminants into the air stream or used potentially explosive gas mixtures, or when the tunnel air heater was used to simulate flight temperatures. The tunnel operated during this mode by continuously drawing outside air through a very large air dryer to remove moisture, and then cooling and exhausting the fumes and highly flammable rocket gasses back into the outside environment in a safe, controlled discharge through a 24-foot (7.3-meter)-diameter valve that was opened during testing. In this mode, engines were tested while running at subsonic and supersonic speeds in the same way they would operate in aircraft and spacecraft. The method was used for “hot” tests, such as evaluating the viability of the advanced supersonic engine inlet that was a key component of the HSCT.³⁶⁴

In the aerodynamic cycle mode, the tunnel ran as a closed-system, variable-density facility that could simulate pressure altitude conditions ranging from 50,000 feet (15,240 meters) to 150,000 feet (45,720 meters). Dry air was added to maintain test conditions. In closed-cycle operation, the tunnel air was recirculated.

The facility was controlled and operated by a digital distributed control system in order to maximize data quality while minimizing operational costs. Steady-state data were collected from

³⁶⁴ Kristin K. Wilson, “Lewis Mach-Speed Wind Tunnel Tests Supersonic Inlet,” *Lewis News* 35, no. 3 (March 1998): pp. 1-2, NASA History Division folder 11713, Historical Reference Collection, NASA Headquarters, Washington, DC.

the model instrumentation, processed, and displayed in engineering units and graphical formats at an update rate of one per second. Transient data with sampling rates of 2 megahertz per second and an optical instrumentation suite of capabilities were also used depending on the test requirements. To increase test productivity, a test matrix sequencer automatically arranged model variables and facility parameters by using a preprogrammed test matrix. Real-time transmission and display of all test data and information were provided to customer locations outside of Lewis.³⁶⁵

The tunnel began operating in 1956 and was rehabilitated and modernized in 1990. The modernization included rewinding and rehabilitating the four 37,000-horsepower main drive motors and three 33,500-horsepower secondary drive motors; rehabilitating the main drive compressor; installing a new drive motor control, tunnel distributed control system, and wind tunnel controls, and upgrading and automating the air dryer.³⁶⁶ Figure 3-47 shows a Mach 5 inlet model in the 10- by 10-foot Supersonic Wind Tunnel.

³⁶⁵ “Abe Silverstein Supersonic Wind Tunnel: Facility Overview,” <http://facilities.grc.nasa.gov/10x10/index.html> (accessed June 4, 2007). Also “Glenn Research Center Test Facilities,” pp. 16, 41, http://facilities.grc.nasa.gov/documents/Facilities_Booklet_2005.pdf (accessed June 4, 2007).

³⁶⁶ Chuck Robertson, “Rehabilitation of 10 by 10 Supersonic Wind Tunnel Improves Productivity,” *Lewis News*, December 22, 1989, NASA History Division folder 11713, Historical Reference Collection, NASA Headquarters, Washington, DC.



Figure 3-47. A researcher checks the configuration of the Mach 5 inlet mounted in the 10- by 10-Foot Supersonic Wind Tunnel (NASA-GRC photo C-1992-5734).

The **1- by 1-foot (0.3- by 0.3-meter) Supersonic Wind Tunnel** was used to conduct detailed fundamental research into supersonic flow, as well as boundary-layer tests derived from the internal fluid dynamics of propulsion-system components and hypersonic fluid mechanics. It was also used for supersonic-vehicle focused research and detailed benchmark-quality experiments for CFD code validation. It went into operation in 1952 and was upgraded in the early 1980s and in 1998.³⁶⁷

This tunnel could provide continuous tunnel operation at 10 discrete airspeeds between Mach 1.3 and (after its 1998 upgrade) Mach 6.0. Researchers could use this tunnel to conduct early proof-of-concept tests. If an outcome was promising, they could scale their models for testing in larger tunnels, thus avoiding the initial cost of full-scale modeling and testing. The small tunnel size also allowed close viewing of tunnel conditions because test articles could be mounted on any of the test section's four walls.³⁶⁸

The **Low-Speed Wind Tunnel Complex** consisted of two test sections. The 8- by 6-foot Supersonic Wind Tunnel was NASA's only transonic propulsion wind tunnel and enabled researchers to explore higher-speed regions of flight. It was used to test advanced aircraft concepts and components, engines for high-speed aircraft, and launch-vehicle concepts. The tunnel's thick stainless steel walls could flex in and out, creating a free-stream airflow that could reach speeds of Mach 0.25–2.0, as well as very low speeds of 0 to Mach 0.1. Aircraft tested in

³⁶⁷ S. Jenise Veris, "1x1 Supersonic Wind Tunnel Test Section Upgraded, *Lewis News* 35, no. 9 (September 1998): p. 7. Also Peñaranda and Freda, *Aeronautical Facilities Catalog, Volume 1, Wind Tunnels*, p. 233.

³⁶⁸ "Glenn Research Center Test Facilities," pp. 17, 41, http://facilities.grc.nasa.gov/documents/Facilities_Booklet_2005.pdf (accessed June 4, 2007).

this facility included the Advanced Turboprop, NASP, Advanced Tactical Fighter, Joint Strike Fighter, and HSCT.

The 8- by 6-foot (2.4- by 1.8-meter) tunnel was built in 1948 and upgraded in 1983 and 1992. The 1992 upgrade included a new, improved speed control system that enabled the facility to reach full-speed Mach 2 test conditions from startup in only 17 minutes (compared with 26 minutes previously), resulting in an obvious improvement in productivity. Other improvements in productivity were also achieved.³⁶⁹ Figure 3-48 shows an artist's view of the NASP nozzle in the 8- by 6-foot tunnel.

³⁶⁹ Edward A. Becks, "Drive System Enhancement in the NASA Lewis Research Center Supersonic Wind Tunnels," June 1998, NASA/CR-1998-207929, AIAA-98-2886, pp. 1-2, <http://gltrs.grc.nasa.gov/reports/1998/CR-1998-207929.pdf> (accessed August 15, 2006).

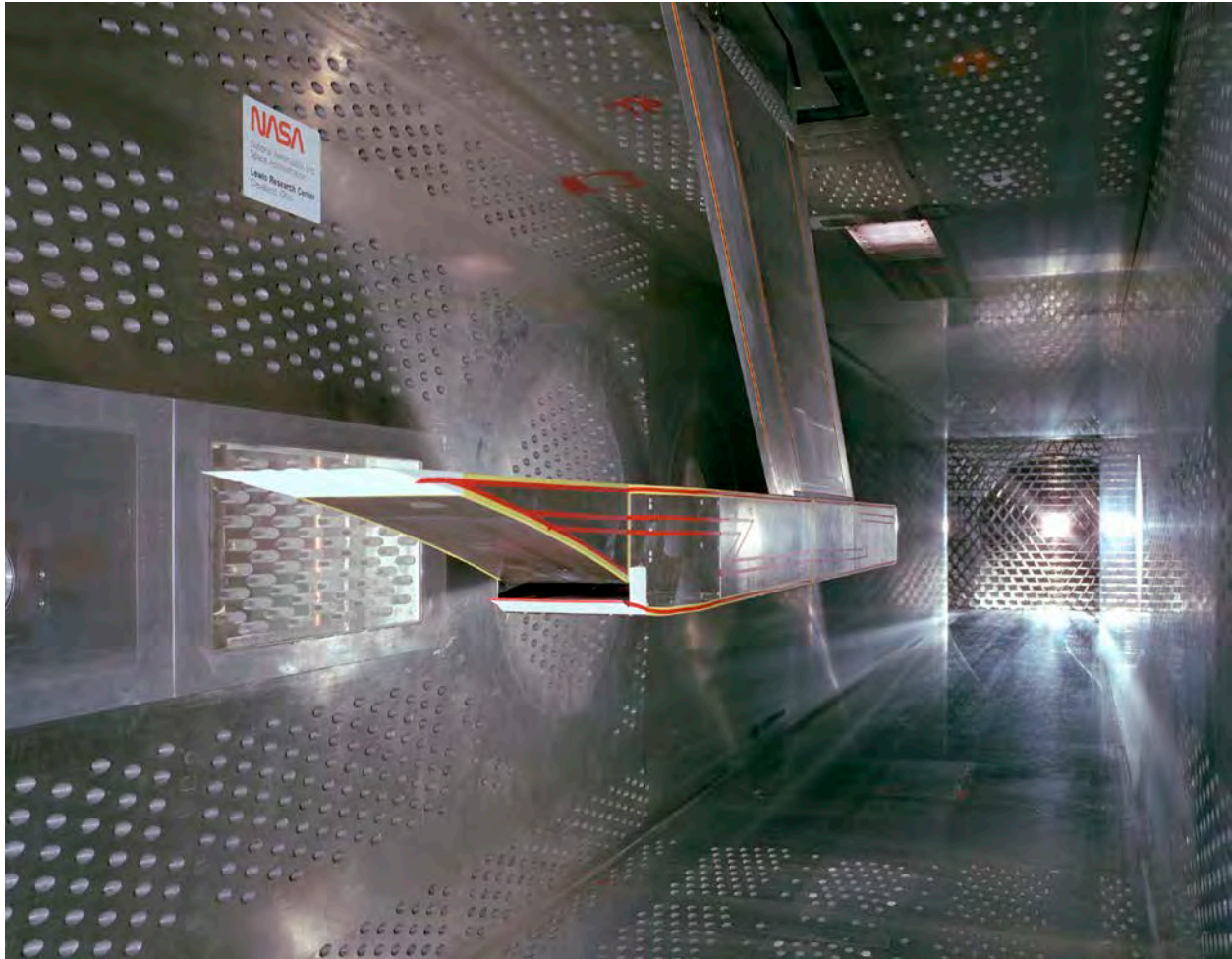

Figure 3-48. Artist's depiction of the National Aerospace Plane's nozzle in the 8- by 6-Foot Supersonic Wind Tunnel (NASA photo C-1991-2038).

The test section of the 9- by 15-foot Low Speed Tunnel, built in 1968, was housed in the return leg of the 8- by 6-foot tunnel. It provided continuous airflow from 0 to 175 miles (282 kilometers) per hour. The facility was used to evaluate the aerodynamic performance and acoustic characteristics of nozzles, inlets, and propellers, and investigate hot gas reingestion of Advanced Short Takeoff and Vertical Landing (ASTOVL) concepts. The programs supported by this facility included a variety of commercial aircraft propulsion systems, the HSCT, the

Advanced Tactical Fighter, the Joint Strike Fighter, and other military STOVL aircraft applications.³⁷⁰ Figure 3-49 shows a nozzle test in the 9- by 15-foot (2.7- by 4.6-meter) tunnel.



Figure 3-49. This photo shows a nozzle test with a wing section in the 9- by 15-foot wind tunnel (NASA-GRC photo C-1992-205).

³⁷⁰ “8x6SW T/9x15 LSWT Complex,” NASA Glenn Research Center, NASA History Division folder 11713, Historical Reference Collection, NASA Headquarters, Washington, DC.

A modernization project initiated in 1989 included the addition of a Distributed Control System (DCS) with a DCS operator display cathode ray tube that allowed much more drive information to be displayed in a simplified format. This was a valuable tool for studying the real dynamics of the tunnel drive system. The complex also began “one-motor operation” in 1995, which reduced the drive train speed drastically and drew approximately 60 percent less electrical power for tests in which a single motor was appropriate.³⁷¹

The **Hypersonic Tunnel Facility (HTF)**, located on 6,400 acres at Lewis’ Plum Brook Station, was originally designed to test nuclear thermal rocket nozzles. It was a hypersonic blowdown, nonvitiated (clean air) wind tunnel that was capable of testing large-scale propulsion systems under true enthalpy flight conditions. The test site had a large exclusion zone that allowed for high-energy, high-risk testing.

The facility contained a large experimental infrastructure that could be readily configured to meet a variety of ground-test applications, including megawatt-level thermal heating, cooling, and electrical systems, and large-capacity gas storage. Test articles could experience multiple gas flow inputs up to 220 pounds (100 kilograms) per second at temperatures and pressures up to 3,600°R (1,727°C) and 1,200 psig (8,274 kilopascal) and altitude conditions up to 120,000 feet (36,576 meters).³⁷²

³⁷¹ Becks, “Drive System Enhancement in the NASA Lewis Research Center Supersonic Wind Tunnels,” pp. 3–4, <http://gltrs.grc.nasa.gov/reports/1998/CR-1998-207929.pdf> (accessed August 15, 2006).

³⁷² The term “psig” stands for “pounds per square inch gauge,” meaning that the pressure is read from a gauge that actually measures the difference between the pressure of the fluid and the pressure of the atmosphere.

The HTF was equipped to test large-scale propulsion systems and flight-rated structures in hypersonic conditions. The main difference between the HTF and other hypersonic facilities was that it used nonvitiated (clean air) flow, whereas traditional hypersonic facilities used a combustion process to generate the high enthalpy conditions required to simulate hypersonic flows. The facility's large scale was also unique. The test section could accommodate test articles up to 14 feet (4.3 meters) long. The large size along with its long run duration allowed for full-system testing of large-scale, flight-rated structures and propulsion systems. This minimized the potential scaling errors associated with ground testing in hypersonic conditions. The HTF also contained NASA's only large-scale nonreacting heater core, which could be used to develop future nuclear thermal propulsion systems. This 3-megawatt heater was fully operational and staffed by a fully trained crew.³⁷³

The facility was originally built in 1966 as the Hydrogen Heat Transfer Facility. It was to be used to develop nuclear rocket engines. In 1971, conversion of the facility into a hypersonic wind tunnel for air-breathing propulsion testing was completed. In 1972, the Hypersonic Research Engine test program began at the HTF. The program was completed in 1974 and the facility went into standby condition. It remained in that condition until 1986, when a study was performed to address the steps required to rehabilitate the facility and return it to operational status. Work on rehabilitation began in 1990 and was completed in 1994. In 1995, a series of integrated systems tests were successfully performed to validate the facility and demonstrate operational readiness. In 1996, testing of the Aerojet strutjet rocket-based combined cycle engine (RBCC) began at the HTF. The purpose of the test program was to demonstrate the engine's

³⁷³ "Glenn Research Center Test Facilities," pp. 18, 41, http://facilities.grc.nasa.gov/documents/Facilities_Booklet_2005.pdf (accessed June 4, 2007).

performance in a free-jet configuration, as well as the HTF's ability to test an RBCC-type engine. More than 40 test runs up to Mach 6.6 were conducted for the program. In September 1996, during a test run for the RBCC test program, a failure occurred with an HTF component, damaging facility systems. Repair work was undertaken in 1997 and completed in 1999. Integrated systems tests were successfully completed in 2000 and validated the full operational capability of the HTF.³⁷⁴

The **Icing Research Tunnel** (IRT) was built at the end of World War II to solve aircraft icing problems, and it has been in continuous operation since 1944. One of NASA's most heavily used wind tunnels, it continues to play a substantial role in developing, testing, and certifying methods to prevent ice buildup and develop next-generation ice protection systems for military and commercial aircraft. Tests performed in the IRT included

- ice protection system development and certification;
- fundamental studies of icing physics;
- icing prediction validation;
- investigation of deicing and anti-icing fluids for use on the ground and on aircraft;
- icing code validation.

The IRT is a closed-return, atmospheric-type wind tunnel in which natural icing conditions are duplicated to study the effects of inflight icing on actual full-size aircraft components and models of aircraft, including helicopters. It simulates actual flying conditions by providing airspeeds

³⁷⁴ Mark R. Woike and Brian P. Willis, "NASA Glenn Research Center's Hypersonic Tunnel Facility," in Frank K. Lu and Dan E. Marren, ed., *Advanced Hypersonic Test Facilities*, Paul Zarchan, editor-in-chief, *Progress in Astronautics and Aeronautics, Volume 198* (Reston, VA: American Institute of Aeronautics and Astronautics, Inc, 2002), pp. 428–429.

ranging from 50 miles (80 kilometers) per hour to 350 miles (563 kilometers) per hour, and air temperatures as low as -30°C (-22°F), controllable to within $\pm 1^{\circ}\text{F}$ (0.6°C). A 12-bladed fan 25.17 feet (7.67 meters) in diameter, powered by a 5,000-horsepower variable-speed motor, generates the airflow. Each blade was fabricated from laminated Sitka spruce.³⁷⁵ The IRT creates a uniform test-section icing cloud that is approximately 5 feet (1.5 meters) high by 6 feet (1.8 meters) wide and consists of supercooled water droplets between 14 and 40 microns in diameter. Detailed analyses and electronic storage of ice-shape data, as well as a wide variety of data-collection and observation methods, have been used. Permanent casts and physical tracings of ice formation have also been created for extended studies.³⁷⁶ Figure 3-50 shows the inside of the IRT.

³⁷⁵ “Virtual Tour of the Glenn Icing Research Tunnel,” <http://www.grc.nasa.gov/WWW/K-12/IRT/irtfanimages.htm> (accessed 21 August 2006).

³⁷⁶ “Glenn Research Center Test Facilities,” pp. 13, 41, http://facilities.grc.nasa.gov/documents/Facilities_Booklet_2005.pdf (accessed 4 June 2007). Also “Aeronautics Facilities: Icing Research Tunnel (IRT) Quick Facts,” <http://www.aeronautics.nasa.gov/atp/facilities/irt/quick.html> (accessed 4 June 2007).

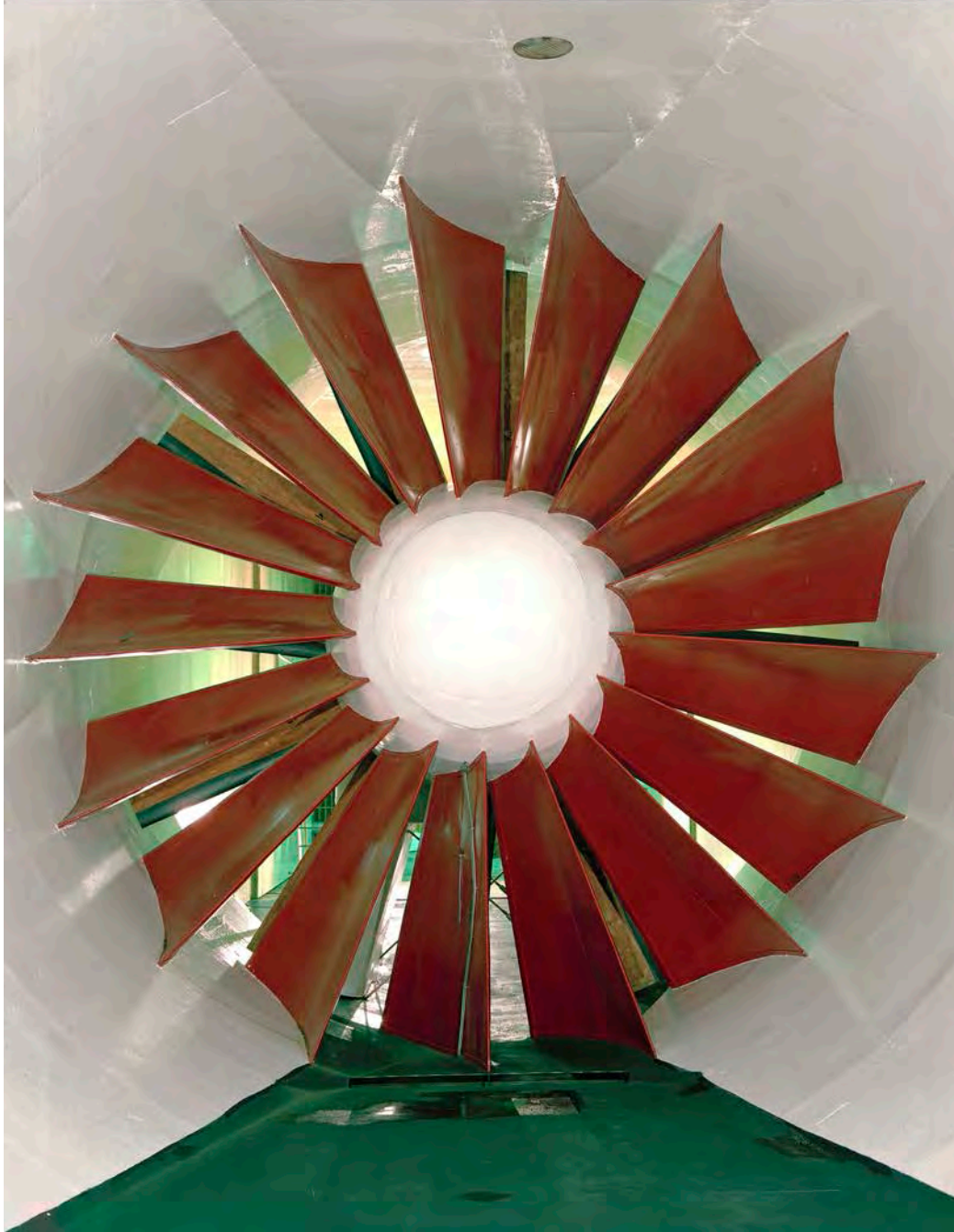

Figure 3-50. Inside of the Icing Research Tunnel (NASA-GRC photo C-1993-2215).

The IRT was closed from February 1986 to January 1988 for major modernization, followed by nearly seven months of calibration.³⁷⁷ The update added a larger fan motor; improved fan blades, computerized tunnel controls, and electronic data acquisition, storage, and processing. Two important elements of the installation were the unique heat exchanger and the spray system that simulated a natural icing cloud of tiny droplets.³⁷⁸ The modernization increased the tunnel's productivity and provided new test capabilities; by the early 1990s it was directly supporting civilian and military manufacturers approximately 60 percent of the time, and operating more than 1,000 hours a year.

The importance of the IRT was demonstrated in the late 1980s and 1990s. In April 1988 and February 1990, IRT tests conducted with a Boeing 737 correlated flight results and wind tunnel data, and investigated the aerodynamic effects of various deicing fluids. The urgency of developing deicing standards became clear following a March 1992 air crash with 27 fatalities. In 1992, the FAA formulated rules that became effective in November 1992 specifying the length of time that could elapse between deicing and takeoff, based largely on tests conducted with NASA's IRT. NASA also participated in a joint program with McDonnell Douglas Aerospace in 1993–1994 on the effects of icing on the performance of advanced, high-lift airfoils.³⁷⁹

Under the leadership of John Reinmann and Robert Shaw, the IRT section investigated the phenomena of icing and the development of better tools to predict its effect. A NASA grant

³⁷⁷ William M. Leary, *"We Freeze to Please": A History of NASA's Icing Research Tunnel and the Quest for Flight Safety* (Washington, DC: National Aeronautics and Space Administration, 2002), pp. 99–101.

³⁷⁸ "Virtual Tour of the Glenn Icing Research Tunnel," <http://www.grc.nasa.gov/WWW/K-12/IRT/history.htm> (accessed 21 August 2006).

³⁷⁹ Leary, pp. 109–116.

enabled the University of Dayton Research Institute to develop the Lewis Ice-Accretion (LEWICE) model, which was delivered to NASA and formally released to U.S. industry in May 1990. Work on LEWICE continued during the 1990s, with new versions released in June 1995 and February 1999.³⁸⁰ Validation of computer codes during the 1980s and 1990s involved flight tests and experiments in the IRT. The IRT was also used extensively in scale modeling programs, especially for helicopters. Tests produced useful data and demonstrated that a model rotor could be successfully tested in the IRT.

During the 1990s, the focus shifted from the ground deicing problems of large transports to in-flight icing difficulties encountered by smaller airplanes. After a fatal crash on 31 October 1994 that killed the crew and 64 passengers, the National Transportation Safety Board asked the Lewis icing branch for technical support in its investigation, especially as it related to icing. The investigation marked the beginning of a major program at Lewis to study the icing conditions found in freezing drizzle and rain, collectively known as “super-cooled larger droplet (SLD) icing.” A series of research flights were conducted from 1994 to 1999 that provided useful information about SLD icing conditions. Related research on tailplane icing in the IRT, as well as by means of flight tests, was conducted jointly by NASA, the FAA, and Ohio State University in the mid and late 1990s. The results of this research were released to the aviation community in a video in 1998 and 1999, and have contributed to improved aircraft safety.³⁸¹

In 1999, NASA Headquarters decided to end the icing flight research program to cut costs. However, after a review by NASA’s Office of Inspector General in January 2000 and a

³⁸⁰ Ibid., pp. 116–119.

³⁸¹ Leary, pp. 131–147.

recommendation in July to resume the program, the decision was reversed.³⁸² Figure 3-51 shows an F-414 engine in the IRT. Figure 3-52 shows an icing test of a delta wing.



Figure 3-51. F-414 engine in the Icing Research Tunnel (NASA-GRC photo C-1995-1204).

³⁸² Ibid., p. 147. Also *Review Report, Review of Research Flight Operations at the Glenn Research Center*, 17 July 2000, IG-00-037, pp. 14–15, <http://oig.nasa.gov/audits/reports/FY00/pdfs/ig-00-037.pdf> (accessed 16 August 2006).



Figure 3-52. This photo shows an icing test of a delta wing in the Icing Research Tunnel (NASA-GRC photo C-95-2932).

Marshall Space Flight Center

The **14- by 14-inch Trisonic Wind Tunnel** was first used by the U.S. Army in the late 1950s under the Army Ballistic Missile Agency (ABMA). Capable of operating in the subsonic, transonic, and supersonic ranges, the tunnel has supported testing of vehicles such as the Redstone, Jupiter, Pershing, and early Saturn, which were tested in the facility in the late 1950s.³⁸³ Under NASA, the 14-inch (35.6-centimeter) tunnel contributed to the Saturn and Space Shuttle projects, and proposed future launch-vehicle programs such as the Shuttle-C and the

³⁸³ The facility is also referred to as the Aerodynamic Research Facility.

National Launch System. In 1997, X-33 configurations underwent extensive tests in the Trisonic Tunnel, with more than 2,500 test runs completed between December 1996 and October 1997.³⁸⁴

The facility was an intermittent trisonic blowdown tunnel that operated from pressure storage to vacuum or atmospheric exhaust. The tunnel could run at subsonic, transonic, and supersonic velocities, and two of the interchangeable test sections measured 14 inches (35.6 centimeters) by 14 inches (35.6 centimeters). The transonic section had interchangeable fixed contour blocks and provided for Mach numbers of 0.20–1.96. The supersonic section had fixed contour plates that were positioned by hydraulic screw jacks and provided for Mach 2.75–5.00. The trisonic facility also had a special test section for a variety of test subjects, including jet interaction and base heating investigations.

Flexibility was a key feature of the tunnel. The large Mach number range required very few tunnel changes and allowed the aerodynamics of a rocket or launch vehicle to be determined with little difficulty. It had both closed and open test sections, easily removable side walls, and variable diffusers, and allowed quick interchange of test sections. Its versatility of design allowed for continuous use since it began operations in 1957 for the U.S. Army. It was transferred to NASA from the ABMA in 1960.³⁸⁵ The tunnel was still operating at the start of 2007. Figure 3-53 shows an overview of the tunnel.

³⁸⁴ Anthony M. Springer, “The George C. Marshall Space Flight Center’s 14x14-Inch Trisonic Wind Tunnel: A Historical Perspective,” AIAA-94-0539, 1994. Also “New Test Methods Used in X-33 Development,” Marshall Space Flight Center News Releases, Release 97-251, 16 October 1997, <http://www.msfc.nasa.gov/news/news/releases/1997/97-251.html> (accessed 15 August 2006).

³⁸⁵ Springer, pp. 1–2. Also “Aerodynamic Research Facility,” <http://ed.msfc.nasa.gov/et/aero2.html> (accessed 15 August 2006).



Figure 3-53. This photo shows an overall view of the Marshall 14- by 14-Inch Trisonic Wind Tunnel. It is capable of running at subsonic, transonic, or supersonic speeds (NASA-MSFC photo MSFC-8891417).

The **Hot Gas Facility** (HGF) was first activated in 1976. It was then redesigned and reactivated in 1987. It was a nominal Mach 4.1 aerothermal tunnel that burned a lean mixture of gaseous hydrogen and missile-grade air. Test conditions closely simulated flight environments for heating rates, local pressure, recovery temperature, and run duration. The HGF was used to test solid rocket booster and external tank TPS materials and configurations.

The HGF could simulate aerodynamic heating environments, such as Space Shuttle ascent trajectories. During a test, combustion products were expanded from the combustion chamber

through a two-dimensional nozzle into a 16- by 16- by 40-inch (40.6- by 40.6- by 101.6-centimeter) test section. A Mach 4 flow environment was induced, and 3.5–25 btu per square foot per second of convective heating could be obtained.

The tunnel was upgraded to include a 300-kilowatt radiant heat system, a model insertion system with varying wedge angles, and test-section shutter doors to protect the test article from startup and shutdown shocks. The improved HGF radiant heat system provided 0–35 btu per square foot per second radiant and could be combined with the Mach 4 convective heat inputs, resulting in a test facility that was ideally suited for base heating environments. Radiant-only heating with programmable vacuum was also available.

All heating environments could be individually profiled within the parameters of the facility to follow a prescribed flight heating profile. If requested, oxygen could be added to the combustor flow to maintain 21 percent oxygen. The HGF also offered thermal imaging support to provide users with real-time thermal response and gradients of the test article. Test environments could also be generated to follow a test article temperature profile. The HGF could provide evaluation of thermal performance, including recession rates, heat transfer rates, temperature profiles, and structural integrity.³⁸⁶

The **High Reynolds Flow Facility** (also called the Ludweig Tube Tunnel and the High Reynolds Number Wind Tunnel) was a Ludweig tube impulse-type wind tunnel with two interchangeable test sections. Air was stored in a constant-diameter supply tube. A run was initiated by rupturing a multilayer Mylar diaphragm, which allowed the air to flow through the test section into a

³⁸⁶ “Hot Gas Facility,” <http://ed.msfc.nasa.gov/et/hotgas.html> (accessed 15 August 2006).

receiver sphere from which it was exhausted to the atmosphere. Maximum stagnation pressure ranged from 550 to 650 pounds per square inch depending on the Mach number, and the stagnation temperature was near ambient. It could accommodate a model 30 inches (76.2 centimeters) long with a span of 18 inches (45.7 centimeters), and had a run time of 0.2–0.6 seconds depending on the pressure. During the run time, the model was bathed in airflow that was constant in pressure and temperature and displayed very little turbulence. One test section had variable-porosity perforated walls, and choking flaps permitting testing at supersonic Mach numbers of 1.4, 1.7, 2.0, 2.75, and 3.5. The tunnel was built in 1968.³⁸⁷ It was shut down in the early 1980s and the majority of its hardware was removed during the early 1990s.³⁸⁸

Space Research and Technology (R&T)

NASA's space R&T program included activities ranging from initial research conceptualization to full-scale testing of prototype equipment in space. The program provided technology for future civil space missions and a base of R&T capabilities to serve all national space goals. It included identifying, developing, validating, and transferring technologies to increase mission safety and reliability, reduce program development and operations costs, enhance mission performance, and enable new missions. It provided the capability to advance technologies in critical disciplines and respond to unanticipated mission needs. Work was performed by NASA staff, university researchers supported by NASA-funded grants and contracts, and industrial

³⁸⁷ Baals and Corliss, pp. 103–104. Also Peñaranda and Freda, *Aeronautical Facilities Catalog, Volume 1, Wind Tunnels*, p. 138; Andrew Dunar and Stephen P. Waring, "Appendix F: Brief Chronology of Facilities Buildup Relating to History of Marshall Space Flight Center (Early 1950s Through 1990)," in *Power to Explore: History of Marshall Space Flight Center, 1960–1990* (Washington, DC: NASA SP-4313, 1999), p. 649, <http://history.msfc.nasa.gov/book/appendf.pdf> (accessed 21 February 2007). Entire book available at <http://history.msfc.nasa.gov/book/index.html>.

³⁸⁸ James Aaron, former team leader for the Experimental Fluid Dynamics Branch, Marshall Space Flight Center, e-mail to author, 23 February 2007.

aerospace organizations under contract to NASA. The program consisted of two complementary parts: the R&T base program and focused-technology programs.

R&T Base

Through the R&T base program, scientists and engineers developed forecasts, usually at a subscale level, regarding the potential applicability, usefulness, and overall benefit associated with new technologies. A variety of activities provided technological breakthroughs and evolutionary technological advances in all of the important space disciplines. Once the potential applicability of a new capability was established, decisions were made as to whether to carry it over into the focused-technology program.³⁸⁹

The space R&T base program consisted of 10 discipline elements: aerothermodynamics, space energy conversion, propulsion, materials and structures, space data and communications, information sciences, controls and guidance, human factors, spaceflight, and systems analysis. In addition, the University Space Research program was supported by the R&T base.

Aerothermodynamics

The objectives of the aerothermodynamics program were to

- develop and apply advanced computational methods and numerical techniques covering the entire spectrum of continuum, transitional, and rarefied flows;
- develop accurate and detailed real-gas chemistry and high-speed turbulent-flow models and efficiently integrate these models with standard computational flow codes;

³⁸⁹ *Aeronautics and Space Report of the President, Fiscal Year 1991 Activities*, p. 60.

- establish a high-quality ground and flight experimental database for code validation and verification;
- directly correlate and compare computations with available ground and flight data;
- establish a detailed aerothermal-loads database and develop fully integrated analysis techniques;
- enhance the ability of engineering design codes advanced configuration analysis to support the rapid evaluation of future vehicle and mission concepts.

Space Energy Conversion

The objective of the space energy program was to develop technology alternatives that would improve the performance, reliability, and cost-effectiveness of space power for human space operations as well as autonomous Earth-orbiting and planetary exploration.

Propulsion

The objectives of the propulsion program were to develop and validate accurate analytical simulations of the chemical and physical processes that occur in space propulsion systems, and to evaluate the potential benefits and feasibility of advanced concepts to improve propulsion capabilities well beyond those achievable with current operational systems. The program included propulsion systems for advanced transportation systems and planetary ascent vehicles. It also focused on Earth-orbiting satellite auxiliary propulsion, which is needed for functions such as attitude control and stationkeeping. Finally, part of the program emphasized the identification and evaluation of very high-energy advanced propulsion concepts. Such concepts, if proven feasible and ultimately practical, would provide a quantum leap in propulsion capabilities that would be relevant to a number of applications.

Materials and Structures

The objective of the Materials and Structures program was to provide technologies that would enable the development of future spacecraft, large-area space structures, and advanced space transportation systems with significant improvements in performance, efficiency, durability, and economy. The major technical areas of materials technology focused on

- gaining a fundamental understanding of the processing, properties, and behavior of advanced space materials, including long-duration synergistic space environmental effects on materials;
- developing lightweight, space-durable materials;
- developing computational methods in chemistry to enable the prediction of nondestructive measurement science for advanced materials;
- assessing the tribological aspects of various materials' behavior in the space environment;³⁹⁰
- developing a wide variety of metallic, intermetallic, ceramic, and carbon-carbon materials for TPS.

Structures technology focused on

- developing erectable and deployable structural concepts;
- devising methods for in-space construction, monitoring, and repair of large complex structures;
- investigating the dynamics of flexible structures and developing concepts for active configuration control and vibration suppression;

³⁹⁰ Tribology is the science of interacting surfaces in relative motion. The study of friction, wear, lubrication, and contact mechanics is an important part of tribology. Related aspects are surface engineering (the modification of a component's surface to improve its function, e.g., by applying a surface coating), surface roughness, and rolling contact fatigue (where repeated contact causes fatigue to occur).

- generating new structural concepts for active cooling of hot structures and cryogenic tanks for advanced Earth-to-orbit rocket propulsion systems, hypersonic vehicles, and orbital transfer vehicles;
- producing efficient analysis and design methodologies for advanced space structures, including multidisciplinary analysis and optimization.

Space Data and Communications

The Space Data and Communications program emphasized the development of technologies to control, process, store, manipulate, and communicate space-derived mission data, and enable new communications concepts.

Information Sciences

The objective of the Information Sciences program was to provide new concepts, techniques, system algorithms and architectures, hardware devices and components, and software to enable viable and productive space information systems. Computer science research was conducted in the areas of information management, concurrent processing, software engineering, and artificial intelligence.

Controls and Guidance

The objectives of the Controls and Guidance program were to

- develop and validate advanced control algorithms for future complex spacecraft (e.g., large flexible antennas, segmented precision optical telescopes and interferometers, multi-instrument Earth-observing platforms, and space stations);
- develop computational control tools for spacecraft control-system design, analysis, and simulation, where modeling several hundred to thousands of states is required for an accurate description;

- produce the technology for advanced sensors and actuators;
- provide the basis for onboard guidance, navigation, and control techniques for future space transportation systems;
- define and develop methodologies for designing and validating highly reliable advanced flight-critical controllers.

Human Factors

The objectives of the human factors program were to provide a technology base for intelligent operator interfaces, especially with highly automated systems, and to develop a new generation of high-performance spacesuits, gloves, effectors, and tools to meet the needs of new space activities and missions. These goals included developing guidelines for human–machine interfaces in spacecraft and workstations, and developing computer-generated models of human performance, capabilities, and limitations in weightless or partial-gravity environments. Human-factors research emphasized crew-station design and extravehicular activities.

Space Flight

The purpose of the spaceflight program was to flight-test enabling technologies that required the actual space environment for validation.

Systems Analysis

The objectives of the systems-analysis program were to identify technological requirements for prescribed mission concepts and opportunities to enable new and improved concepts, to integrate these into a comprehensive set of technology planning options, and to generate candidate plans to develop these technologies in a timely manner. The program was directed toward the systems-focused areas of space transportation, spacecraft, and large space systems, as well as emerging mission concepts and mission-enabling technologies. Spacecraft systems analysis emphasized

the areas of astrophysics, space physics, Earth science, communications, and solar systems exploration. Space transportation systems analyses were focused on advanced Earth-to-orbit (ETO) vehicles, aeroassist space transfer vehicles, and conceptual design and analysis methods for advanced space transportation systems.

University Space Research

A key element of the space R&T base program was developing and sustaining a strong partnership with the university community. The University Space Research program enhanced and broadened the capabilities of the engineering community through active research participation in the U.S. civil space program. The program provided support to selected universities that helped to “research and develop technologies relevant to operational bases on the Moon, to spaceflight missions to other parts of the solar system, and to spaceflight operations in the future, such as envisioned by the National Commission on Space.”³⁹¹

In April 1988, nine University Space Engineering Research Centers were competitively selected to participate in the program. Among the technologies developed was a method to combine fragile carbon fibers with hardened resin to create strong, lightweight, damage-tolerant, heat-resistant materials that were stronger than their individual components. This material was developed for possible use in constructing a Mars-bound spacecraft that would be developed at the Mars Mission Research Center at North Carolina State University and North Carolina A&T University in FY 1991. Another technological development, made by faculty members and graduate students at the University of Cincinnati, consisted of a series of microsensors to indicate the health of components on spacefaring vehicles, including monitoring gas and liquid fuel flows inside a Shuttle engine and its associated support systems. Spinoff applications, such as in the

³⁹¹ *Aeronautics and Space Report of the President, 1989–1990 Activities*, p. 65.

care of premature infants, were being investigated at the University of Cincinnati's Medical Center.³⁹² In FY 1992, students and faculty at the University of Michigan made progress toward developing devices to measure the chemical makeup of the upper atmosphere, which would be useful for studying global-change issues such as ozone depletion.³⁹³

NASA ended base grant funding for the University Space Engineering Research Centers in 1995. Support for ongoing degree programs ended in 1997.³⁹⁴

Focused-Technology Programs

Focused-technology development programs were based on the identified and projected needs of both current and future space missions. Technologies were developed for specific applications and products were delivered in the form of software, large-scale hardware technology demonstrations, and design techniques and methods. In the early part of the decade, the Civil Space Technology Initiative (CSTI) and the In-Space Technology Experiments (In-STEP) program were the primary focused programs. In addition, the Exploration Technology program (formerly called Pathfinder), provided technology for future potential space missions.

CSTI

CSTI began in 1988 and was initially broken down into five technological areas: space science, exploration/planetary surface, space platforms, transportation, and operations.³⁹⁵ It focused on developing technologies to enable efficient, reliable access to Earth orbit, enhance operations in Earth orbit, and increase the effectiveness of science missions from Earth orbit. Through 1990,

³⁹² *Aeronautics and Space Report of the President, Fiscal Year 1991 Activities*, pp. 65–66.

³⁹³ *Aeronautics and Space Report of the President, Fiscal Year 1992 Activities*, p. 24.

³⁹⁴ "Space Technology University Programs," http://ranier.hq.nasa.gov/Sensors_page/University/Univ.html (accessed 18 August 2006).

³⁹⁵ *Aeronautics and Space Report of the President, Fiscal Year 1991 Activities*, p. 60.

CSTI was organized into programs for automation and robotics, information technology, propulsion, vehicle, large structures and control, and power. In 1991, a realignment changed the programs to operations (incorporating power and controls/structures interaction, an area of large structures and controls), transportation (incorporating propulsion and vehicle), science (incorporating information technology and precision segmented reflectors, an area of large structures and controls), and automation and robotics.

In 1992, automation and control broke off from the CSTI program and became an independent program called Space Automation and Telerobotics. It included the telerobotics and artificial intelligence programs and technology demonstration elements of the Flight Telerobotic Servicer program, which previously had been part of the Space Station Freedom program. It lasted as an independent program only until 1993, when it moved back to the CSTI program. In 1993, a restructuring incorporated activities that were formerly supported by the Exploration Technology and Space Automation and Telerobotics programs into the Planetary Surface and Transportation Technology programs and the Operations Technology program, respectively.

In-STEP

The In-STEP program began in 1990. The program was part of NASA's space R&T maturation strategy and played an important role in the transition of technology from research and development into flight systems. It advanced technological concepts that had been developed in NASA, industry, and university facilities. Such concepts required flight evaluations and validations to reduce the risk of incorporating them into advanced space systems.³⁹⁶ In late 1992 to early 1993, NASA selected 52 proposals to develop small-technology flight experiments for

³⁹⁶ "STS-62," March 1994, p. 23, NASA History Division folder 11035, Historical Reference Collection, NASA Headquarters, Washington, DC.

the program. The awards covered eight areas of technology identified as a high priority by NASA's customers.³⁹⁷ In-STEP ended in 1993 as an independent program when it moved into the space R&T base, and in FY 1995 it moved into flight programs.

Exploration Technology

The Exploration Technology program began in the fall of 1988 as the Pathfinder program. This program supported President Bush's National Space Policy, which directed NASA to begin planning for future solar system exploration missions. NASA stated that the goal of the Exploration Technology program was to develop "the critical technologies required for future solar system exploration missions including establishment of a base on the Moon and manned exploration of the planet Mars."³⁹⁸

Space Station/Space Platforms Technology

The Space Station Technology area addressed the technologies needed to increase safety and human productivity on the space station, enhance its productivity and efficiency as a laboratory and testbed for science and technology, and enable future growth. In 1990, a significant accomplishment in the area of artificial-intelligence applications was the laboratory demonstration of the first dual-arm telerobotic manipulator. The arms had seven degrees of manipulative freedom and could be used in both teleoperator and robotic modes to perform external maintenance tasks. Another important achievement was the development of a high-fidelity graphics phantom robot that used the latest graphics display techniques to simulate dual-arm robotic action in response to teleoperator commands, and thus enable precise planning of telerobotic tasks.

³⁹⁷ *Aeronautics and Space Report of the President, Fiscal Year 1993 Activities*, p. 32.

³⁹⁸ *Aeronautics and Space Report of the President, 1989–1990 Activities*, p. 55. Also *Aeronautics and Space Report of the President, Fiscal Year 1991 Activities*, p. 63.

A new space construction technique developed by Langley Research Center and demonstrated in the neutral-buoyancy facility at Marshall Space Flight Center used an astronaut mobility platform on either side of a general-purpose mobile transporter. The platforms were suspended from the transporter by arms that enabled the astronauts to have fully controlled planar motion along the truss bay. The transporter held magazines that automatically dispensed each truss element as needed. After a section was constructed, the transporter would crawl along the recently constructed structure and become a platform for the construction of a new segment. Researchers claimed that this device could enable astronauts to construct large structures, such as the space station truss, seven times faster than the fully manual method then planned. Another space-platforms accomplishment was the first ground test of an integrated space solar dynamics power system, which was critical for the solar dynamic flight experiment on Shuttle-*Mir*.

In 1990, germanium metal was tested as a new material for thermal energy storage, which was to be used to increase the power capability of the space station. The highly corrosive action of germanium on common container materials was overcome by encapsulating the germanium in graphite.³⁹⁹

Space and Earth Science Technology

In 1990, the Advisory Committee on the Future of the U.S. Space Program issued a report stating that science was the center point of the entire civil space effort.⁴⁰⁰ The Space and Earth Science Technology area focused on developing advanced observation information, spacecraft, and operations technologies to maximize the return from NASA's space and Earth science missions

³⁹⁹ *Aeronautics and Space Report of the President, 1989–1990 Activities*, p. 54.

⁴⁰⁰ Advisory Committee on the Future of the U.S. Space Program, *Report of the Advisory Committee on the Future of the U.S. Space Program*, December 1990, <http://www.hq.nasa.gov/office/pao/History/augustine/racful1.htm> (accessed 15 March 2005).

over the next 20 years.⁴⁰¹ It supported technological developments, expanding capabilities and reduced costs through disciplinary advances, increased science information return and spacecraft performance, and enabled the next generation of space science missions in these program areas. It aimed at developing space-based instrument component and detector technologies to enable new space science measurements, and space instrument support and observation technologies to maximize scientific returns from these missions. This emphasis included spacecraft and remote-sensing encompassing technologies that advanced spacecraft in support of NASA's MTPE, space science missions, and space platform applications. It focused particularly on lower-power spacecraft that were physically smaller and less expensive, but more capable. This area developed technologies in advanced composites and integrated spacecraft design concepts, and demonstrated micro-instruments.

In 1990, the Spacecraft Health Automated Reasoning Prototype (SHARP), an expert system designed to monitor the condition of interplanetary spacecraft and ground operations, demonstrated a leap in automation technology during Voyager's encounter with Neptune. The SHARP system automatically confirmed that a problem had occurred in the attempt to recover and process data from Voyager transmissions from Neptune. It defined the magnitude of the problem and helped determine the cause of the malfunction (a specific failed electronic unit on the ground, which was replaced). The process of identifying and isolating the problem was much less laborious and time-consuming than it would have been using traditional methods.⁴⁰²

⁴⁰¹ *Aeronautics and Space Report of the President, Fiscal Year 1991 Activities*, p. 61.

⁴⁰² *Aeronautics and Space Report of the President, 1989–1990 Activities*, p. 52.

In 1990, a submillimeter-wavelength, backward-wave oscillator (BWO) prototype was demonstrated. This enabled the design of a high-frequency oscillator that was capable of achieving significant power while being continuously tunable at submillimeter wavelengths. As a result, sensors could be developed in the use of very high-frequency submillimeter wavelengths for the space spectroscopy required for space astrophysics, upper-atmosphere remote sensing, and solar system exploration.

Researchers at Lewis Research Center built upon a previous record of 22 percent efficiency in a prism-covered gallium arsenide cell operating in a simulated space solar intensity, and developed a domed Fresnel lens that provided a working concentration ratio of 100:1. The use of this plastic lens allowed cheaper, lighter-weight concentrator arrays for high-efficiency operation to be built.

At the same time, the Jet Propulsion Laboratory (JPL) worked to develop an ultra-lightweight, high-performance, advanced, deployable, photovoltaic-array design that would be suitable for a broad range of long-term space applications. The goal was to achieve a specific power of 130 watts per kilogram, which was about six times higher than most arrays and twice as high as the high-performance experimental Solar Array Flight Experiment (SAFE) NASA flew on the Space Shuttle in 1984. Analysis based on the components built and the detailed engineering drawings indicated that TRW, under contract to JPL, achieved the goal of 130 watts per kilogram.⁴⁰³

Technologies developed by the program were key to developing the star trackers used on the December 1990 Astro-1 Space Shuttle mission. The Astro star tracker became especially important for mission success when problems with the prime star trackers prevented the

⁴⁰³ *Aeronautics and Space Report of the President, 1989–1990 Activities*, pp. 52–53.

instrument pointing system from locking onto the operational guide stars. The Astro star tracker then became the primary means of acquiring a target.

Researchers also demonstrated a diode-pumped, two-micron, solid-state laser that was being investigated for potential use in NASA's Earth Science program. Possible applications included the measurement of global winds and atmospheric carbon dioxide concentrations. In FY 1991, researchers demonstrated 2.122-micron lasing at 30°C (86°F) with good efficiency. Additional experiments demonstrated for the first time both high efficiency and gain for the same laser amplifier. The laser obtained optical gains of 10 for low amounts of incident light. These accomplishments enabled eye-safe lidars (light detecting and ranging laser radar) with greater range and sensitivity.⁴⁰⁴

In 1992, engineers baselined the technology for a high-efficiency, low-power traveling-wave tube amplifier to transmit all the Cassini data from Saturn back to Earth. The new amplifier used technology that would increase output and efficiency and recover energy being used for data transmission for reuse. Such advances would enable Cassini to return more data to Earth with low distortion and less energy than was used at the time, enhancing scientific returns.⁴⁰⁵

In the area of aerothermodynamics, NASA engineers used computer simulation to plan the aerobraking of the Magellan spacecraft so as to move it into a lower, more circular orbit around Venus with little use of the minimal fuel on board, thereby enhancing the mapper's resolution.⁴⁰⁶

⁴⁰⁴ *Aeronautics and Space Report of the President, Fiscal Year 1991 Activities*, pp. 61–62.

⁴⁰⁵ *Aeronautics and Space Report of the President, Fiscal Year 1992 Activities* (Washington, DC: National Aeronautics and Space Administration, 1993), p. 20.

⁴⁰⁶ *Aeronautics and Space Report of the President, Fiscal Year 1992 Activities*, p. 20.

In support of future astronomical missions, NASA's Space Science Technology program completed low background tests for an imaging array. This technology would directly enhance scientific returns through a large format that would allow simultaneous imaging of four times as much area as the then-current state-of-the-art technology. The program also demonstrated a simple control algorithm that could reduce the vibrations of current flight coolers for sensitive instruments by a factor of 2,000.⁴⁰⁷

In FY 1994, analysis of data from the retrieved Long Duration Exposure Facility (LDEF) was completed.⁴⁰⁸ This data analysis was one component of the larger technical area of space environment and effects, a program initiated in FY 1995 as a follow-on to LDEF that focused on reducing the design and operations margins needed to account for uncertainties in the effects of space and the environment. The products delivered in FY 1995 included a contamination control guideline for spacecraft design; the completed development of white and black, tailorable electrically conductive thermal control coatings; and an integrated database for environmental effects and spacecraft materials. The coatings were particularly noteworthy because no conductive coatings had been available before to reduce either the structure floating potential or spacecraft charging (a significant cause of spacecraft failures in geosynchronous orbit).

In September 1994, in the Earth science area, two radar flights and the successful flight of the Laser In-Space Technology Experiment (LITE) on the Space Shuttle laid the groundwork for an effort to reduce the mass and size of active (laser and radar) sensing instruments and make them

⁴⁰⁷ Ibid., p. 20.

⁴⁰⁸ LDEF was deployed from the Space Shuttle in 1984 on STS-41-C. Its planned retrieval was temporarily delayed in 1985 and then indefinitely delayed by the *Challenger* accident in 1986. It was finally retrieved in January 1990 on the STS-32 mission.

compatible with the new paradigm of small space missions.⁴⁰⁹ LITE was the primary payload on STS-64 and the first spaceborne lidar to measure critical atmospheric parameters. It captured unprecedented atmospheric data that were provided to the Earth Observation System (EOS) program for correlation with ground data.⁴¹⁰ The same year, NASA competitively selected an industry concept for an advanced infrared telescope with twice the collecting area, half the mass, and one-third the diffraction-limited wavelength of the previously flown Infrared Astronomy Satellite (IRAS).

In FY 1995, NASA's Instrument and Sensing Technology program demonstrated large-format infrared arrays, which could be produced for both Earth science and astrophysics missions. A new 256- by 256-element array with the potential for reducing the mass, power requirements, and complexity of Earth-observing instruments in the 15- to 20-micron range, which is critical for studying Earth's environment from space, was demonstrated. In addition, progress in developing microelectromechanical systems components led to a flight demonstration of a microhygrometer that outperformed current, large instruments.⁴¹¹

During the same period, Ames Research Center developed software that planned, scheduled, controlled, and monitored telescopes. It was used on four telescopes at Fairborn Observatory in Arizona. All U.S. manufacturers of automated telescopes were also using the technology.

Additionally, Ames developed a super-resolution algorithm that was applied to a sequence of

⁴⁰⁹ *Aeronautics and Space Report of the President, Fiscal Year 1994 Activities* (Washington, DC: National Aeronautics and Space Administration, 1995).

⁴¹⁰ "Flight Programs," Office of Space Access and Technology Fiscal Year 1996 Estimates, p. SAT 5-32.

⁴¹¹ *Aeronautics and Space Report of the President, Fiscal Year 1995 Activities* (Washington, DC: National Aeronautics and Space Administration [no date]), p. 30.

21 images of the asteroid Gaspra taken by Galileo. The resulting images showed craters and other features with a far greater resolution than any of the individual input images.⁴¹²

Also in FY 1995, a major strategic change within NASA shifted emphasis to enabling technologies for the next generation of planetary, Earth-observing, and space science spacecraft, which would be much smaller than the traditional 1,000-kilogram (2,200-pound)-class spacecraft and launched on small to medium ELVs. The next-generation spacecraft would also be much more autonomous than current spacecraft to reduce the overall life-cycle cost.⁴¹³

Exploration Technology/Planetary Surface

The objective of NASA's Exploration Technology/Planetary Surface activities was to develop the critical technologies needed for future solar system exploration missions, including human exploration of Mars and establishing a base on the Moon. This program, which supported President Bush's Space Exploration Initiative, began in the fall of 1988 as the Pathfinder program.

Through FY 1991, the Exploration Technology program supported the SP-100 program, an ongoing NASA, DOD, and DOE space nuclear power research and development program. In 1990, it successfully completed key accelerated life testing of reactor fuel pin elements. With no appreciable swelling of the fuel pins even after a 5 percent fuel burnup, the tests demonstrated that lifetimes of seven years should be achievable with SP-100 technology. In FY 1991, researchers completed the fuel pin design and fabrication process for the reactor, achieving the

⁴¹² "Spacecraft and Remote Sensing," Office of Space Access and Technology, Fiscal Year 1997 Estimates, p. SAT 5-23.

⁴¹³ "Spacecraft and Remote Sensing," Office of Space Access and Technology Fiscal Year 1996 Estimates, p. SAT 5-14.

design goal of burnup to 6 percent with prototypic fuel in representative fuel pins, and completing development of uranium nitride fuel pellets for a generic 100-kilowatt electric space reactor power system. The program also successfully demonstrated the bonding of the fuel pin cladding to the rhenium liner. The liner was needed to protect the fuel pins from fusion gases.⁴¹⁴ The program ended in FY 1994.

Preliminary technology development took place in the sensor areas of the Sample Acquisition, Analysis, and Preservation program. A spectrometer breadboard for visible and near-infrared sensing was completed and demonstrated. This could be applied to sensor systems for early robotic sampling missions on Mars. Tests were also conducted on rock-coring techniques and parameters using robotic arms and drill fixtures in a laboratory environment.

In addition, in 1990, the Exploration Technology program's planetary rover effort completed fabrication and began testing two experimental mobile robot concepts: a multichassis, six-wheeled rover concept and a six-legged walking rover concept. Both rovers traveled over gentle and rugged terrain during the testing phase. In FY 1991, a milestone was reached as researchers developed and demonstrated a semiautonomous navigation system for robotic wheeled planetary rovers, and tested the vehicle on a 100-meter (328-foot) test course. This was the first use of an autonomous navigation and control system for recognizing and traversing natural terrains without human teleoperation. The legged rover, known as Ambler, demonstrated high mobility and an ability to cross large obstacles while using less power.⁴¹⁵ As a step toward accomplishing the Mars Pathfinder mission, in FY 1995 a NASA planetary rover conducted a 10-kilometer (6.2-

⁴¹⁴ *Aeronautics and Space Report of the President, Fiscal Year 1991 Activities*, p. 64.

⁴¹⁵ *Ibid.*

mile) autonomous trip across natural terrain, with human control limited to designating the vehicle's heading and end goal. A Mars-like planetary rover demonstrated several 100-meter (328-foot) autonomous trips over simulated Martian terrain. A lunar rover prototype was also developed.⁴¹⁶

The program also continued to develop, in conjunction with industrial partners, a robotically assisted microsurgery system that could precisely manipulate surgical tools for ocular surgery. The manipulations were constrained to a 1-cubic-inch (16.3-cubic centimeter) work envelope and had to achieve very high levels of precision and repeatability. NASA was developing such robotic surgery tools for potential use in telemedicine on long-duration human space missions.⁴¹⁷

The space telerobotics program completed development and integration of the Tesselator, a robotic system designed to inspect and process the thermal protection tiles on the Space Shuttle orbiter, and delivered the system to Kennedy Space Center. Additionally, the program developed an autonomous surface-inspection technology for robotic examination of exposed surfaces on space structures, and delivered the inspection technology to the space station program at Johnson Space Center. The program also completed initial development of a neutral-buoyancy engineering vehicle for the Ranger telerobotic technology and began testing the system in the Neutral Buoyancy Research Facility at the University of Maryland.

In the area of human support in space, an exercise facility for studying the human metabolic response to orbital extravehicular activity (EVA) work was completed in 1990 at Ames Research

⁴¹⁶ "Spacecraft and Remote Sensing," Office of Space Access and Technology Fiscal Year 1997 Estimates, p. SAT 5-23.

⁴¹⁷ *Aeronautics and Space Report of the President, Fiscal Year 1995 Activities*, p. 31.

Center. The facility simulated EVA work to obtain human metabolic responses. The results were used to design thermoregulatory control methods that would more accurately reflect the EVA work requirements and make spacesuits more comfortable for the astronauts, particularly on lengthy EVA missions.⁴¹⁸

Researchers in FY 1991 developed a systems analysis tool in the area of regenerative life support that could perform rigorous system and technology trade-off analyses quickly and inexpensively. The modeling tool allowed investigators to identify the relative benefits of each technology without having to commit to costly hardware designs. It was shown to be versatile for analyzing a wide variety of regenerative life-support systems, including potential systems for both lunar and Mars base missions (such as carbon dioxide removal and reduction, oxygen generation, potable water processing, hygiene water, and human waste processing).⁴¹⁹

Space Transportation Technology

Space Transportation Technology activities focused on providing safer and more efficient access to space while reducing the overall costs associated with a space launch. These efforts addressed the technology required to design a new fleet of space vehicles, including new expendable and partially reusable cargo launch vehicles; fully reusable, crewed vehicles; and expendable and reusable space transfer vehicles. Activities emphasized the development of more efficient vehicle structures; lightweight, more durable thermal protection materials; and lightweight, long-lived cryogenic tanks. They also focused on critical technologies related to Earth-to-orbit propulsion and transfer vehicles, including space-based research and terrestrial applications in materials processing and biotechnology through experiments using the space environment. A goal was to

⁴¹⁸ *Aeronautics and Space Report of the President, 1989–1990 Activities*, pp. 55–56.

⁴¹⁹ *Aeronautics and Space Report of the President, Fiscal Year 1991 Activities*, p. 64.

help develop next-generation super- and semiconductors, special coatings and composites, polymers, alloys, and new catalytic materials. Studies indicated that significant weight and cost savings could result from recent accomplishments in materials and structures technology. For example, in 1990, panels of aluminum alloy were superplastically formed into stiffeners and spot-welded to aluminum skin structures. Additionally, tests indicated that these structural components would be useful for fabricating cryogenic tanks for space transportation vehicles.

Space propulsion technology researchers in 1989 and 1990 demonstrated a high-temperature, oxidation-resistant coating for uncooled, bipropellant thrusters. The advanced thrust chambers increased the life of the thrusters by a factor of 10 and specific impulse by at least 10 percent over existing thruster capability. This could be done because the oxidation-resistant iridium coating enabled the use of rhenium, which can operate at temperatures up to 4,000°F (2,204°C)—approximately twice the temperature of conventional materials—but alone cannot withstand the effects of oxidation. The program also investigated the feasibility of extending the operating life of the Shuttle’s reaction control system vernier engines by replacing the silicide-coated niobium chambers with ones made of iridium-coated rhenium. Results showed that iridium-rhenium technology could eliminate or significantly reduce vernier chamber replacements.⁴²⁰

The same year, a lifting-body design for an Assured Crew Return Vehicle (ACRV) for Space Station Freedom was analyzed. The assessment involved wind tunnel studies and trajectory, performance, structural, and subsystems analyses.

⁴²⁰ *Aeronautics and Space Report of the President, 1989–1990 Activities*, p. 53.

The first successful operation of a compact, high-speed, liquid-oxygen turbopump with a gaseous oxygen drive was achieved in 1990. This type of turbine, which pumps liquid but is driven by gas, was crucial in the development of a high-performance expander cycle engine for future deep-space exploration.⁴²¹

The Advanced Space Transportation program, which included the Low-Cost Booster Technology (LCBT) project and the Advanced Reusable Transportation Technologies project, began in early 1996. Its goal was to “dramatically reduce space transportation costs across the mission spectrum” and at a “cost-to-orbit measured in hundreds, not thousands, of dollars per pound.”⁴²² In April 1996, Marshall Space Flight Center released a NASA Research Announcement (NRA) for low-cost booster technologies for its Bantam System Technology Project. The goal was to identify readily available technologies and demonstrate their use for a propulsion system capable of lifting approximately 500 pounds (227 kilograms) to orbit for about \$1 million. The project looked to small businesses that were not traditionally associated with aerospace as well as to traditional aerospace companies for “fresh ideas and innovative approaches” to a new low-cost launch system for small payloads. It hoped to adapt common manufacturing techniques and existing commercial hardware to aerospace applications, and perhaps save “millions of dollars.”⁴²³ A technology demonstration flight was targeted for late 1999.

⁴²¹ Ibid., pp. 55–56.

⁴²² “Advanced Space Transportation Technology,” Fiscal Year 1998 Estimates, p. SAT 4.2-5.

⁴²³ “Low Cost Technologies,” Marshall Space Flight Center Fact Sheet: FS-1997-06-004-MSFC, June 1997, <http://www.nasa.gov/centers/marshall/news/background/facts/lct.html> (accessed 25 August 2006).

The project was divided into two phases. The first phase called for proposals for components, including an engine, propellant delivery systems, tanks, pressurization and pneumatic systems, associated structures, and electronics.⁴²⁴ On 26 July 1996, Marshall Space Flight Center selected 15 proposals for negotiation leading to a possible contract award for its LCBT project.⁴²⁵ Seven first-cycle proposals and two second-cycle proposals were awarded, and the first agreement was signed in October 1996. The project also included development of the engine for the X-34 RLV at an initial budget of \$18.9 million.⁴²⁶

An NRA for the second phase was released early in 1997. It called for proposals to develop technologies for a launch system that would integrate new technologies with technologies that were developed in the first phase.⁴²⁷ In June, Marshall selected four companies—Universal Space Lines, Summa Technology, Aerojet-General, and Pioneer Rocketplane—for negotiations leading to contract awards for the initial design of a flight demonstrator of new low-cost launch system technologies.⁴²⁸ The Hybrid Propulsion Demonstration program, which began under a separate project in FY 1995, was incorporated into the LCBT project in FY 1996. The Hybrid program was conducted under a cooperative agreement among NASA, the DOD, and U.S.

⁴²⁴ “NASA Seeks Low-Cost Propulsion Technology From Unlikely Sources,” Marshall Space Flight Center News Releases, Release 96-32, 29 April 1996, <http://www.msfc.nasa.gov/news/news/releases/1996/96-032.html> (accessed 3 July 2006). Also “Low Cost Technologies,” Marshall Space Flight Center Fact Sheet: FS-1997-06-004-MSFC, June 1997, <http://www.nasa.gov/centers/marshall/news/background/facts/lct.html> (accessed 25 August 2006).

⁴²⁵ “Nine Companies To Demonstrate Small, Low Cost Launch System Technologies, *NASA News* Release 96-146, 25 July 1996, <ftp://ftp.hq.nasa.gov/pub/pao/pressrel/1996-96-146.txt> (accessed 30 June 2006).

⁴²⁶ U.S. General Accounting Office, “Space Transportation: Critical Areas NASA Needs to Address in Managing Its Reusable Launch Vehicle Program—Statement of Allen Li, director, Acquisition and Sourcing Management, on NASA’s X-33 and X-34 Programs, GAO-01-826T, 20 June 2001, <http://www.gao.gov/new.items/d01826t.pdf> (accessed 4 June 2007).

⁴²⁷ “NASA Asks for Industry Ideas To Put Small Payloads into Orbit at Lowered Costs,” Marshall Space Flight Center News Releases, Release 97-017, no date, c. March 1997, <http://www.msfc.nasa.gov/news/news/releases/1997/97-017.html> (accessed 3 July 2006).

⁴²⁸ “NASA Selects Four Companies To Demonstrate Low Cost Launch System Technologies,” Marshall Space Flight Center News Releases, Release 97-096, 9 June 1997, <http://www.msfc.nasa.gov/news/news/releases/1997/97-096.html> (accessed 3 July 2006).

industry. Its objective was to demonstrate hybrid propulsion technology to enable the commercialization of hybrid boosters for space launch operations by U.S. industry.⁴²⁹

An additional NRA for advanced reusable transportation technologies that would use a combination of air-breathing and rocket engines to reduce the weight and cost of future launch vehicles was released in April 1996.⁴³⁰ Four rocket-based, combined-cycle propulsion systems were selected for proof-of-concept ground demonstrations in late FY 1997.⁴³¹ Over the next two years, the selected companies worked to develop their concepts in both areas. By the end of 1998, they had not yet completed their development efforts.

Reusable Launch Vehicles (RLVs)

The development of RLV technology was a major focus of NASA's space R&T program. NASA Administrator Goldin initiated the "Access to Space" study in 1993 to identify alternative, less expensive approaches for gaining access to space that would also increase safety for flight crews. The study report was released in January 1994, followed later that year by the first executive policy specifically recommending the development of an RLV. On 5 August 1994, President Clinton released a National Space Transportation Policy document giving NASA responsibility for developing and demonstrating new RLVs to replace the Space Shuttle.⁴³² In response, NASA established the RLV Technology program in late 1994 to develop and flight-test experimental RLVs. The DOD worked with NASA on this program, bringing expertise in such areas as flight-

⁴²⁹ "Advanced Space Transportation Technology," Office of Aeronautics and Space Transportation Technology, Fiscal Year 1998 Estimates, p. SAT 4.2-6.

⁴³⁰ "NASA Selects Five Organizations To Develop Technologies for an Air-Breathing Rocket Engine," Marshall Space Flight Center News Releases, Release 96-57, 11 July 1996, <http://www.msfc.nasa.gov/news/news/releases/1996/96-057.html> (accessed 3 July 2006).

⁴³¹ "Advanced Space Transportation Technology," Fiscal Year 1998 Estimates, p. SAT 4.2-11.

⁴³² The White House, Office of Science and Technology Policy, Presidential Decision Directive, National Science and Technology Council (NSTC)-4, *National Space Transportation Policy*, 5 August 1994, <http://www.au.af.mil/au/awc/awcgate/nstc4.htm> (accessed 28 June 2006).

testing, operations, and composite structures. Private industry also participated in the partnership to develop a new generation of launch vehicles. The program consisted of the Delta Clipper-Experimental Advanced (DC-XA), X-34, X-33, and related long-term technology development efforts.

Delta Clipper

The Delta Clipper Experimental (DC-X) program, which was initiated by the Ballistic Missile Defense Organization (BMDO) in 1990, supported NASA's RLV program. It successfully tested an experimental suborbital launch vehicle in a series of flight tests beginning in 1993. The early RLV efforts were conducted by the U.S. Air Force Phillips Laboratory at Kirtland Air Force Base, New Mexico, under the auspices of the BMDO Single-Stage Rocket Technology program. This program's charter was to demonstrate the practicality, reliability, operability, and cost-efficiency of a fully reusable, rapid-turnaround, single-stage rocket. Its ultimate goal was to develop RLVs that could perform aircraft-like operations. The program focused on using existing technologies and systems to demonstrate the feasibility of building suborbital- and orbital-flight RLVs that could fly into space, return to the launch site, and be serviced and ready for the next mission within three days.

As the result of a design and risk-reduction competition, a \$60 million contract was awarded to McDonnell Douglas in August 1991 to build the DC-X. The DC-X design emphasized simplified ground and flight operations and vehicle maintenance, rapid turnaround, and operational characteristics that would also be relevant for future orbital vehicles.

The flight-test program began in mid-1993. It started with low-altitude hover flights that gradually increased in altitude and duration, and eventually performed suborbital flights to approximately 18,000 feet (5,486 meters). The DC-X flew a total of eight test flights in 1993, 1994, and 1995. The 1995 flights supported NASA's RLV program. The test flight on 27 June 1994 experienced an on-board fire and successfully demonstrated the vehicle's autoland capabilities. On 12 June 1995, the vehicle climbed to 5,700 feet (1,737 meters) and demonstrated for the first time the use of four gaseous oxygen-hydrogen thrusters.⁴³³ On the 7 July 1995 flight, following a successful flight demonstrating the vehicle's ability to turn itself around and reverse direction, the aeroshell cracked during landing, damaging the vehicle and ending the tests. At the conclusion of this test, the DC-X was officially turned over to NASA, which returned the vehicle to McDonnell Douglas for conversion into the DC-XA.⁴³⁴

The DC-XA was a modified DC-X with technology intended for use in the X-33 and X-34 RLVs that were being developed by NASA and its industry partners. The DC-XA had a lightweight graphite-epoxy liquid-hydrogen tank and an advanced graphite/aluminum honeycomb intertank built by McDonnell Douglas, an aluminum-lithium liquid-oxygen tank built by Energia, and an improved reaction control system from Aerojet. These improvements reduced the dry vehicle mass by 620 kilograms (1,367 pounds). NASA and the DOD operated the DC-XA under NASA's RLV program. The flight vehicle was tested at White Sands, New Mexico, during the summer of 1996. It demonstrated a short 26-hour turnaround time between its second and third flights, a record for any rocket. Figure 3-54 shows the first DC-XA test flight.

⁴³³ *Aeronautics and Space Report of the President, Fiscal Year 1995 Activities*, p. 26.

⁴³⁴ "DC-X Fact Sheet," BMDOLINK, <http://www.hq.nasa.gov/office/pao/History/x-33/dcx-facts.htm> (accessed 22 March 2005).

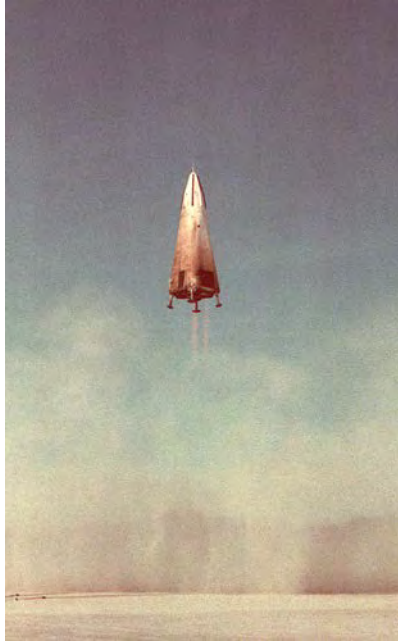

Figure 3-54. First flight of the Delta Clipper-Experimental Advanced (DC-XA), 18 May 1996 (NASA-MSFC photo MSFC-9607854).

The DC-XA flew until it was destroyed. During its fourth demonstration flight on 31 July 1996, a landing strut failed to extend, causing the unbalanced vehicle to tip over on its landing pad. The liquid-oxygen tank exploded and there were indications of secondary explosions in the liquid-hydrogen tank. The ensuing fire damaged large sections of the vehicle. An investigation board later determined that an unconnected helium pressurant line that supplied hydraulic pressure to extend the landing strut caused the explosion. The program ended due to lack of funding to build a new vehicle.

X-34

The X-34 program, also known as the Reusable Small Booster program, was to bridge the gap between the earlier subsonic DC-XA vehicle and the larger and higher-performance X-33 demonstrator. It was to demonstrate the application of RLV technologies through the design and

flight-testing of fully autonomous vehicles capable of achieving up to Mach 8 and 250,000 feet (76,200 meters) altitude.⁴³⁵ The technologies would significantly reduce the cost of access to space. It was anticipated that the air-launched X-34 would demonstrate technologies and operations that could cut launch costs from \$10,000 per pound in 1999 to \$1,000 per pound.⁴³⁶ The X-34 program also served as a testbed for a number of new reusable launcher technologies and supported the commercial development of low-cost RLVs in the small payload class that would be achieved through an industry-led partnership between NASA and industry. The partnership would last 30–36 months and have a fixed government budget.⁴³⁷

On 12 January 1995, NASA issued a Cooperative Agreement Notice (CAN) requesting proposals for the development of technology demonstrators for the RLV program. Sponsored by the Office of Space Access and Technology, the X-34 CAN intended to (1) stimulate joint industry/government-funded development of a small reusable, or partially reusable, booster that would potentially be applicable to commercial launch vehicles and significantly reduce mission costs for placing small payloads into a low-Earth orbit, and (2) demonstrate technologies that would be applicable to future RLV systems. Some of these technologies could be demonstrated as a part of the basic booster design, while others would be included in the testbed application of

⁴³⁵ R. Bryan Sullivan and Brian Winters, “X-34 Program Overview,” Orbital Sciences Corporation, AIAA-1998-3516, AIAA/ASME/SAE/ASEE Joint Propulsion Conference and Exhibit, 34th, Cleveland, OH, 13–15 July 1998, NASA History Division folder 18559, Historical Reference Collection, NASA Headquarters, Washington, DC.

⁴³⁶ “X-34 Rocket Plane Update: NASA, Summa Technology, Inc. Sign \$11 Million Contract For Fastrac Engine Flight Program,” Science Daily, <http://www.sciencedaily.com/releases/1999/08/990804184711.htm>. Also Frank Bokulich, “X-34 Is on the Fastrac,” Aerospace Engineering Online, <http://www.sae.org/aeromag/spacetechn/> (both accessed 6 March 2007).

⁴³⁷ John R. London III and Stephen D. Creech, “X-34 Program Status,” American Institute of Aeronautics and Astronautics, AIAA-1998-5211, Report No. IAF-98-V-4-04, October 1998, NASA History Division folder 18559, Historical Reference Collection, NASA Headquarters, Washington, DC. Also Andrew Buttrica, “The Policy Origins of the X-33; Part VII: The X-34,” X-33 History Project Fact Sheet #7, 25 March 2005, http://www.hq.nasa.gov/pao/History/x-33/facts_7.htm (accessed 13 February 2007).

the booster to demonstrate alternate technologies.⁴³⁸ The technological developments included autonomous ascent, reentry, and landing; composite structures; reusable liquid-oxygen tanks; rapid vehicle turnaround; and a durable TPS. The versatile flight testbed could accommodate future experiments, including space transportation and technology developments and aerospace experiments. The expected NASA program funding through FY 1999 was \$70 million. The proposals were due to NASA by 24 February 1995.⁴³⁹

On 8 March, in a “fast-track” procurement process, NASA selected the Orbital Sciences Corporation to enter into negotiations for the X-34 (other bidders were Space Access and Kelley Space and Technology, Inc.).⁴⁴⁰ The anticipated development schedule supported flight tests beginning in late 1997, orbital launch by mid 1998, and testbed applications later in 1998. Industry–government cost-sharing was a major element of the program.⁴⁴¹ On 30 March, NASA signed a cooperative agreement with Orbital Sciences, teaming with Rockwell International Corporation, to develop a small, reusable space booster—the X-34—to serve as a testbed to demonstrate RLV technology. The two companies formed a jointly owned firm called American Space Lines to develop, operate, and market the vehicle. Each company invested \$50 million in the project, and NASA contributed \$70 million plus personnel and facilities at Marshall, Langley, Dryden, Ames, and Johnson. The envisioned three-stage commercial vehicle consisted

⁴³⁸ “Reusable Launch Vehicle Notices Issues,” *NASA News Release 95-1*, 12 January 1995, <http://www.nasa.gov/home/hqnews/1995/95-1.txt> (accessed 26 February 2007).

⁴³⁹ Buttrica, “The Policy Origins of the X-33; Part VII: The X-34,” http://www.hq.nasa.gov/pao/History/x-33/facts_7.htm (accessed 13 February 2007).

⁴⁴⁰ “NASA Evaluates Seven RLV Proposals,” *Aviation Week and Space Technology* 142, no. 10 (6 March 1995): p. 63. Northrop Grumman also developed a design concept that was not formally submitted in the X-34 program competition. It would be launched from on top of a NASA B-747 aircraft and deliver a payload to low-Earth orbit. The B-747 launch platform would transfer liquid oxygen and liquid hydrogen fuels to the orbital vehicle. Dan Gonzalez et al., “Design Options and Issues,” *Proceedings of the RAND Project Air Force Workshop on Transatmospheric Vehicles*, p. 51, http://www.rand.org/pubs/monograph_reports/MR890/MR890.chap3.pdf (accessed 13 February 2007).

⁴⁴¹ “X-33, X-34 Contractors Selected for Negotiations,” *NASA News Release 95-23*, 8 March 1995, <http://www.nasa.gov/home/hqnews/1995/95-23.txt> (accessed 26 February 2007).

of a large B-747 aircraft, a fully reusable rocket-powered booster, and a small expendable orbital vehicle.⁴⁴²

The X-34 was to progress rapidly through hardware design, flight tests in late 1997, and an expected launch by mid-1998. Orbital Sciences and the government, however, had difficulty agreeing on the best engine for the X-34, resulting in the company missing two program milestones. Consequently, on 2 November 1995, the NASA X-34 program managers issued a 14-day suspension notice to Orbital Sciences, shutting down the program and allowing NASA time to review the program. The suspension lasted only one day.⁴⁴³ Discussions among representatives of Orbital Sciences, Rockwell, NASA's Office of Space Access and Technology, and NASA Administrator Daniel Goldin continued in December, but no agreement was reached. Orbital began questioning the entire design of the vehicle and its anticipated profitability. On 24 January, the company issued a "stop work order" to its contractors. The action was taken because of design problems and the increasing weight and costs of the X-34. On 15 February 1996, Orbital formally withdrew from the cooperative agreement, partly because of changes in the projected profitability of the venture. One week earlier, Rockwell International had also decided to leave the partnership.⁴⁴⁴

⁴⁴² "X-34 Small Reusable Booster," Cooperative Agreement No. NCC 8-75, Effective Date: 30 March 1995, NASA History Division folder 18559, Historical Reference Collection, NASA Headquarters, Washington, DC. Also Buttrica, "The Policy Origins of the X-33; Part VII: The X-34," http://www.hq.nasa.gov/pao/History/x-33/facts_7.htm (accessed 13 February 2007).

⁴⁴³ Buttrica, "The Policy Origins of the X-33; Part VII: The X-34," http://www.hq.nasa.gov/pao/History/x-33/facts_7.htm (accessed 13 February 2007).

⁴⁴⁴ David P. Radzanowski and Marcia S. Smith, "Space Launch Vehicles: Government Requirements and Commercial Competition," CRS Issue Brief 93062, Updated 14 November 1996, <http://www.fas.org/spp/civil/crs/93-062.htm> (accessed 13 February 2007). Also "X-34," <http://www.globalsecurity.org/space/systems/x-34.htm> (accessed 23 March 2005) and Buttrica, "The Policy Origins of the X-33; Part VII: The X-34," http://www.hq.nasa.gov/pao/History/x-33/facts_7.htm (accessed 13 February 2007).

NASA officials decided to continue by using the \$65 million of government money remaining for the project to build a scaled-down version of the X-34. A new NASA Research Announcement (NRA), issued on 27 March 1996, focused on the technology demonstration flight tests rather than on the vehicle's commercial potential. On 10 June, NASA announced its selection of Orbital for the restructured fixed-price contract, and the contract was finalized in August.⁴⁴⁵ The 30-month contract had a value of approximately \$49.5 million, with \$10 million more to be spent by NASA in direct support of the project.⁴⁴⁶ The project was based on an air-launched concept that incorporated many advanced technologies, including composite primary and secondary airframe structures, composite fuel tanks, an advanced TPS and materials, low-cost avionics (such as a differential GPS), integrated vehicle health monitoring, and a flush air data system.⁴⁴⁷ The contract called for two powered test flights scheduled to begin in late 1998 at the White Sands Missile Range in New Mexico. The contract had an option for up to 25 additional test flights after the initial contract period had ended.⁴⁴⁸

The proposed winged, reusable, single-engine vehicle would be propelled by a kerosene/liquid-oxygen engine and was expected to demonstrate several key technologies. These included (1) composite primary and secondary airframe structures; (2) cryogenic insulation and propulsion system elements; (3) advanced TPSs and materials; (4) low-cost avionics, including differential global positioning and inertial navigation systems; and (5) key operations technologies, such as integrated vehicle health-monitoring and automated checkout systems. It was expected to

⁴⁴⁵ Other bidders were Lockheed Martin Skunk Works, McDonnell Douglas, Northrop Grumman, Rockwell International, du Pont Aerospace, Pioneer Rocket Place, Space Access, and Truax Engineering (Buttrica).

⁴⁴⁶ Radzanowski and Smith, "Space Launch Vehicles: Government Requirements and Commercial Competition," <http://www.fas.org/spp/civil/crs/93-062.htm> (accessed 13 February 2007).

⁴⁴⁷ *Aeronautics and Space Report of the President, Fiscal Year 1996 Activities*, p. 32.

⁴⁴⁸ "NASA Finalizes X-34 Contract With Orbital Sciences Corp.," NASA Marshall Space Flight Center News Releases, Release 96-161, 30 August 1996, <http://www.msfc.nasa.gov/news/news/releases/1996/96-161.html> (accessed 23 March 2005).

significantly reduce mission costs for sending 1,000- to 2,000-pound (454- to 907-kilogram) payloads into low-Earth orbit.⁴⁴⁹ The vehicle would be air-dropped from beneath Orbital's L-1011 aircraft, reach speeds of Mach 8, and fly at altitudes of approximately 50 miles (80 kilometers). It would also demonstrate the ability to conduct subsonic flights through rain or fog and land autonomously in crosswinds of up to 20 knots (23 miles or 37 kilometers per hour).

The government team included Marshall Space Flight Center (responsible for the main propulsion system, including the Fastrac engine), Langley Research Center (wind tunnel testing and analysis), Ames Research Center (TPS), Dryden Flight Research Center, Holloman Air Force Base, White Sands Test Facility, and White Sands Missile Range (testing and flight-support operations).⁴⁵⁰

The Fastrac engine, which was only the second U.S.-made engine developed in the prior 25 years, was chosen as the primary propulsion system for the X-34 demonstration vehicle when it began its flight tests.⁴⁵¹ The 60,000-pound (267-kilonewton) thrust engine burned liquid oxygen and kerosene in a simple gas generator cycle. Its major components were a turbopump assembly, thrust chamber assembly, chamber/nozzle, gas generator, lines/valves and ducts, and electrical harness/instrumentation. Development of the Fastrac engine began in April 1996 based on successful subscale component test programs. Fastrac II, a flight-like manufacturing

⁴⁴⁹ Ibid.

⁴⁵⁰ "NASA Finalizes X-34 Contract With Orbital Sciences Corp.," NASA Marshall Space Flight Center News Releases, Release 96-161, 30 August 1996, <http://www.msfc.nasa.gov/news/news/releases/1996/96-161.html> (accessed 23 March 2005).

⁴⁵¹ "X-34 Fastrac Engine Passes Critical Tests," NASA News Release 97-232, 14 August 1997, <http://www.msfc.nasa.gov/news/news/releases/1997/97-232.html> (accessed 23 March 2005).

demonstration, was successfully tested in September 1996.⁴⁵² In August 1997, a critical series of tests on the Fastrac engine were successfully completed at Marshall Space Flight Center (see figure 3-55).



Figure 3-55. This photo shows an X-34 40K Fastrac II duration test performed at Marshall Space Flight Center in June 1997 (NASA-MSFC photo MSFC-9705975).

In May 1997, a government-Orbital review was held to finalize the design of the vehicle. This allowed the program to proceed with the fabrication and manufacturing of various systems, including structures, guidance, navigation and control, avionics, thermal protection, and main propulsion systems.⁴⁵³ Metal model wind tunnel tests took place at Langley during 1997 (see figure 3-56). Tests of the Fastrac engine were carried out on the ground at Holloman Air Force Base, New Mexico. Vibration and captive-carry tests took place at Dryden Flight Research Center in 1999 and later. NASA began full-engine, hot-fire testing of the Fastrac rocket engine in

⁴⁵² Danny Davis, "Fastrac 60K Engine," NASA Marshall Space Flight Center, NASA History Division folder 18559, Historical Reference Collection, NASA Headquarters, Washington, DC). Also Danny Davis, "The Fastrac 60K Engine," White Paper, 27 March 1998, NASA History Division folder 18559, Historical Reference Collection, NASA Headquarters, Washington, DC).

⁴⁵³ "X-34 Systems Design Freeze Completed," *NASA News Release 97-107*, 22 May 1997, <http://www.qadas.com/qadas/nasa/nasa-hm/0872.html> (accessed 25 March 2005).

March 1999. In May 1999, the complete engine system was tested for the first time at full power for 155 seconds, the length of time it would be required to perform during an X-34 flight.

System-level testing continues at Stennis Space Center, and component testing was performed at Marshall Space Flight Center.⁴⁵⁴



Figure 3-56. A metal model of the X-34 reusable launch vehicle being tested in the Low-Turbulence Pressure Tunnel at Langley Research Center, 1997 (NASA-LaRC photo EL-1997-00048).

⁴⁵⁴ “Fastrac Engine,” Advanced Space Transportation Technology Summary,” http://www.nasa.gov/centers/marshall/pdf/100364main_Fastrac_Tech_Brief1.pdf (accessed 14 February 2007).

To reduce program risk, NASA decided in January 1998 to modify its contract with Orbital to provide for a second flight vehicle. The modification would also allow for additional unpowered tests and more flexibility in demonstrating various technologies. The change increased the contract value by \$7.7 million to purchase long-lead-time hardware. NASA committed \$2 million more for wind tunnel testing, additional testing and analysis, and a second leading-edge TPS. An \$8.5 million option called for the purchase of shorter-lead-time hardware, while a \$1.8 million option was added for assembly.

In July 1998, the program passed a critical milestone when the first wing assembly completed its qualification tests. It was then shipped to Orbital and mated to the X-34 test vehicle under construction. It was ultimately to fly aboard one of the two flight vehicles being built at Orbital.

At the end of 1998, NASA exercised its option with Orbital for 25 additional test flights during a 12-month period beginning immediately after completion of the initial contract. Flights were to take place at the U.S. Army's White Sands Missile Range in New Mexico. The option was valued at more than \$10 million, with government organizations performing additional work for \$4.7 million.⁴⁵⁵

The first of three planned X-34 technology demonstrators was "rolled out" on 30 April 1999 at Dryden Flight Research Center. The vehicle took its first test flight locked underneath the L-1011 carrier aircraft in June 1999. In August 1999, an \$11 million contract for the Fastrac engine was awarded to Summa Technology. Assembly and preflight tests continued through 2000.

⁴⁵⁵ "NASA Exercises X-34 Contract Option for 25 Test Flights," Marshall Space Flight Center News Releases, Release 98-251, 18 December 1998, <http://www.msfc.nasa.gov/news/news/releases/1998/98-251.html> (accessed 23 March 2005).

However, in March 2001, NASA decided not to add funds to the X-34 program from money dedicated to the Agency's Space Launch Initiative because the government determined that "the benefits to be derived from continuing the X-34 program did not justify the cost."⁴⁵⁶ This action coincided with the end of NASA's contract with Orbital. By the time the project ended, NASA had spent \$205 million on the X-34 since its inception in 1996.

X-33

The X-33 Advanced Technology Demonstrator program (the third RLV program) was to demonstrate a half-scale single-stage-to-orbit vehicle that could go from launch to orbit without using multiple stages (as did ELVs) or dropping rocket motors and fuel tanks (as did the Space Shuttle). Flying as fast as Mach 15, it was to decrease the per-pound cost of putting payloads into space from \$10,000 to \$1,000 while at the same time dramatically increasing launch vehicle safety and reliability.⁴⁵⁷ Ultimately, the goal of the full-size vehicle, named the VentureStar, was to resupply the space station more quickly and cheaply than the Space Shuttle could.⁴⁵⁸

Figure 3-57 shows an artist's depiction of the VentureStar.

⁴⁵⁶ "NASA Reaches Milestone in Space Launch Initiative Program; Also Announces No SLI Funding for X-33 or X-34," Marshall Space Flight Center News Releases, Release 01-062, 1 March 2001, <http://www.msfc.nasa.gov/news/news/releases/2001/01-062.html> (accessed 27 June 2006).

⁴⁵⁷ "X-33 Advanced Technology Demonstrator Fact Sheet," Historical Fact Sheet, <http://www.nasa.gov/centers/marshall/news/background/facts/x33.html> (accessed 27 June 2006).

⁴⁵⁸ "X-33 Venture Star—Reusable Launch Vehicle," <http://nix.ksc.nasa.gov/info;jsessionid=4egbp0h8ftqq5?id=MSFC-9610538&orgid=11> (accessed February 2007).



Figure 3-57. In this artist's concept, the X-33 VentureStar, manufactured by Lockheed Martin Skunk Works, is shown in orbit with a deployed payload (NASA-MSFC photo MSFC-9610538).

The program, however, turned out to be a risky venture with unproven technologies that challenged its developers. In particular, the design required the development of linear aerospike rocket engines, which had never been used in flight and had been rejected by Space Shuttle developers 25 years earlier. It also required the development of a wingless “lifting-body” airframe that could keep the vehicle flying smoothly both during launch and on its return to Earth, and composite fuel tanks that could withstand the pressures of a space launch while filled with pressurized liquid hydrogen at a temperature of -423°F (-253°C).⁴⁵⁹

NASA initiated this NASA–industry partnership through a Cooperative Agreement Notice (CAN) for Phase I concept definition and design of a technology demonstrator vehicle, the X-33, issued in January 1995. In March, NASA signed cooperative agreements with three companies—Lockheed Advanced Development Company (the Skunk Works), McDonnell Douglas Aerospace teamed with Boeing, and Rockwell International Corporation—to design the vehicle. The

⁴⁵⁹ “NASA’s Billion-Dollar Shuttle Replacement May Never Fly,” *CNN.com/Space* (25 September 2000), <http://archives.cnn.com/2000/TECH/space/09/25/trouledspaceship.ap/index.html> (accessed 24 March 2005).

agreement called for NASA to work with each of these companies over the next 15 months on vehicle concept definition and design. The government would provide approximately \$7 million to each of the companies, and each was expected to match the investment.

Each company produced a design concept. All of the vehicles would take off vertically, but only the McDonnell Douglas vehicle was designed to land vertically; the others landed horizontally like an airplane.

- Lockheed Martin's design featured a lifting-body vertical takeoff, horizontal landing aeroshell with an integrated linear aerospike engine. The X-33 was to be a 53 percent version of the full-scale RLV, dubbed the VentureStar. The design used metallic TPS materials on all external surfaces except for the leading edges, which would be constructed with advanced carbon-carbon composites.
- The McDonnell Douglas/Boeing entry was an approximately 50 percent subscale vertical-takeoff, vertical-landing design with ballistic hypersonic characteristics.⁴⁶⁰ The design relied on ceramic TPS materials. The full-scale RLV would be about as tall as the Space Shuttle on the launch pad. McDonnell Douglas/Boeing also conducted trade studies on other vehicle options, including horizontal landers. The team's propulsion choices were the near-term modified space shuttle main engine (SSME) for the X-33 and an SSME-derived engine (with an RD-O120 Russian engine for the RLV).

⁴⁶⁰ McDonnell Douglas had built the DC-X vehicle.

- The Rockwell concept for the RLV and X-33 vehicles was based on a wing-body approach with vertical liftoff and horizontal landing capabilities. The 50 percent X-33 had a composite wing and tail and would rely on TPS blankets for all exterior surfaces except the leading edges, where high-density ceramic tiles would be used.⁴⁶¹ For propulsion, Rockwell planned to use a near-term modified SSME for the X-33 and the new RS-2100 engine for the RLV.⁴⁶²

At the beginning of April 1996, NASA issued another CAN for Phase II of the project, regarding the design, fabrication, and flight-testing of the X-33 demonstrator. This was the first time that a cooperative agreement rather than a conventional contract had been used for a program of this size. This phase of the project was planned to end in flight demonstration testing of the X-33 beginning in early 1999. NASA and industry would share costs during this phase.

On 2 July 1996, after a selection process of only a few months (due to an innovative paperless procurement process) and amid much fanfare, Vice President Albert Gore announced NASA's selection of Lockheed Martin to build the X-33 test vehicle. According to the terms of the agreement, Lockheed would design, build, and conduct the first test flight of the remotely piloted demonstration vehicle by March 1999, and would conduct at least 15 flights by December 1999. Major components would include a more robust metal heatshield in place of the Space Shuttle's tiles, a composite primary structure and fuel tank, and a linear aerospike engine.⁴⁶³ The X-33 design was based on a lifting-body shape that would be launched vertically like a rocket and land

⁴⁶¹ Dan Gonzalez et al., "Design Options and Issues," Proceedings of the RAND Project Air Force Workshop on Transatmospheric Vehicles, pp. 43–50, http://www.rand.org/pubs/monograph_reports/MR890/MR890.chap3.pdf (accessed 13 February 2007).

⁴⁶² Commission on Engineering and Technical Systems (CETS), National Research Council, *Reusable Launch Vehicle: Technology Development and Test Program* (Washington, DC: National Academies Press, 1995), p. 14, http://books.nap.edu/openbook.php?record_id=5115&page=14 (accessed 26 February 2007).

⁴⁶³ *Aeronautics and Space Report of the President, Fiscal Year 1996 Activities*, p. 32.

horizontally like an airplane. NASA had budgeted \$941 million for the effort. Lockheed initially invested \$220 million of its own funds in the design.

In 1997, the project successfully passed two important milestones. The Critical Design Review (CDR) in October ended 51 subsystem and component CDRs that had been held earlier that year. It allowed the program to proceed with fabricating the remaining components, completing the subsystems, and assembling the subscale prototype launch vehicle. Earlier in the year, the project attempted to resolve issues regarding vehicle weight and aerodynamic stability and control by modifying the design of the vehicle's canted and vertical fins, and it planned to reduce the weight by using composite materials and densified propellants.⁴⁶⁴ In November, NASA completed the environmental impact statement process, which allowed all 15 test flights to proceed from the launch site at Haystack Butte on the eastern part of Edwards Air Force Base, California, and land at Michael Army Air Field, Dugway Proving Ground, Utah, and Malmstrom Air Force Base near Great Falls, Montana.⁴⁶⁵

The next major milestone was the completion of flight-testing of the TPS materials. The tests took place in May and June 1998 at Dryden Flight Research Center on its F-15B Aerodynamic Flight Facility aircraft. The F-15B tests measured the air loads on the proposed X-33's protective materials. In contrast, shock-load tests investigated the local impact of the supersonic shock wave itself on the TPS materials. Similar tests had been done in 1985 for the Space Shuttle tiles

⁴⁶⁴ "X-33 Program Successfully Completes Critical Design Review," *NASA News Release 97-250*, 31 October 1997, <ftp://ftp.hq.nasa.gov/pub/pao/pressrel/1997/97-250.txt> (accessed 15 March 2005).

⁴⁶⁵ "NASA Completes X-33 Environmental Impact Statement Process," *NASA News Release 97-254*, 5 November 1997, <ftp://ftp.hq.nasa.gov/pub/pao/pressrel/1997/97-254.txt> (accessed 15 March 2005).

using an F-104 aircraft.⁴⁶⁶ The plane reached an altitude of 36,000 feet (10,973 kilometers) and a top speed of Mach 1.4 during the tests. The materials in the TPS included metallic Inconel tiles, soft Advanced Flexible Reusable surface insulation tiles, and sealing materials. Figure 3-58 shows a photo of the NASA F-15B being used in tests of the X-33 TPS materials on 14 May 1998.



Figure 3-58. Inflight photo of the NASA F-15B used in tests of the X-33's thermal protection system (TPS) materials, 14 May 1998 (NASA-DFRC photo EC98-44554-31).

Tests of the linear aerospike rocket engine took place at Dryden during seven research flights in 1998. The Linear Aerospike SR-71 Experiment (LASRE), which was jointly carried out by NASA, Rocketdyne, and Lockheed Martin, was designed to provide inflight data to help

⁴⁶⁶ "F-15B in Flight with X-33 Thermal Protection Systems (TPS) on Flight Test Fixture," <http://www.dfrc.nasa.gov/Gallery/Photo/F-15B/HTML/EC98-44554-31.html> (accessed 14 February 2007).

Lockheed Martin evaluate the aerodynamic characteristics and the handling of the SR-71 linear aerospike experiment configuration and validate the computational predictive tools that were being used to determine the aerodynamic performance of a future RLV. The experiment was a 20 percent scale, half-span model of a lifting-body shape (X-33) without the fins. It was rotated 90 degrees and equipped with eight thrust cells of an aerospike engine, and was mounted on a type of housing known as a “canoe” that contained gaseous hydrogen, helium, and the instrumentation gear. The model, engine, and canoe together were called a “pod.” The experiment focused on determining how the RLV’s engine flume would affect the aerodynamics of its lifting-body shape at specific altitudes and speeds. Since interaction between the aerodynamic flow and the engine plume could create drag, researchers looked at design refinements to minimize the interaction. The entire pod was 41 feet (12.5 meters) in length and weighed 14,300 pounds (6,531 kilograms). The experimental pod was mounted on one of the SR-71s, which was then on loan to NASA from the U.S. Air Force.

Two initial flights were used to determine the aerodynamic characteristics of the LASRE apparatus (pod) on the back of the SR-71. Five later flights focused on the experiment itself. Two were used to cycle gaseous helium and liquid nitrogen through the experiment to check its plumbing system for leaks and to test the engine’s operational characteristics. During the other three flights, liquid oxygen was cycled through the engine. Two engine hot firings were also completed on the ground. A final hot-fire test flight was canceled because of liquid-oxygen leaks in the test apparatus. Ultimately, LASRE was canceled because leak-detection techniques were unable to verify that oxygen levels could be maintained below flammability limits.⁴⁶⁷

⁴⁶⁷ “Linear Aerospike SR-71 Experiment (LASRE) During First In-flight Cold Flow Test,” <http://www1.dfrc.nasa.gov/gallery/photo/SR-71-LASRE/HTML/EC98-44440-13.html>. Also Neal Hass et al.,

Meanwhile, in March 1998, NASA's Office of Safety and Mission Assurance (OSMA) performed a Safety and Mission Assurance (SMA) review of the X-33 program. The review team found that Lockheed Martin used "rigorous safety, mission assurance, and risk management processes...throughout the X-33 program." Nevertheless, it recommended increasing NASA's "insight" and participation in the SMA process. This was especially important in light of November 1997 legislation that made NASA a partner in the damage and injury liability associated with any X-33 failure, but gave the Agency only a small "insight" role and precluded it from exercising oversight of the program.⁴⁶⁸

NASA's Office of Inspector General was also investigating the program. The first inquiry examined whether NASA's use of a cooperative agreement for the X-33 program was appropriate for the program and "whether the agreement effectively defined roles, responsibilities, and rights of the Government and industry partners."⁴⁶⁹ A secondary objective was to determine whether NASA's implementation and management of the program were consistent with congressional guidance. An audit determined that obligated funds for Lockheed had not been recorded in a timely manner, a potential violation of federal law. Consequently, the inspector general concluded that reports and financial statements "did not accurately reflect the

"Propellant Feed System Leak Detection—Lessons Learned from the Linear Aerospike SR-71 Experiment (LASRE)," NASA/TM-1999-206590, November 1999, p. 1,

<http://dtrs.dfrc.nasa.gov/archive/00000101/01/206590.pdf> (both accessed 15 February 2007).

⁴⁶⁸ NASA Office of Safety & Mission Assurance, "X33 Safety & Mission Assurance Review,"

http://pbma.nasa.gov/docs/public/pbma/casestudies/306_F_X_33_Part1.pdf and

http://pbma.nasa.gov/docs/public/pbma/casestudies/306_F_X_33_Part2.pdf (accessed 13 February 2007). The report refers to NASA's "insight" role as one in which the industry partner has responsibility for determining how the program will be implemented and accountability for meeting program milestones.

⁴⁶⁹ Office of Inspector General, National Aeronautics and Space Administration, "Audit Report: X-33 Funding Issues," IG-99-001, 3 November 1998, pp. 1–3, <http://oig.nasa.gov/audits/reports/FY99/pdfs/ig-99-001.pdf> (accessed 4 June 2007).

financial status” of the program.⁴⁷⁰ The next year, another audit from the Office of Inspector General examined whether the government had adequately addressed the cost of the project and its cost risk in its cost estimate. It concluded that a better risk analysis “would have alerted NASA decisionmakers to the probability of cost overruns” that “put NASA’s investment . . . at risk.”⁴⁷¹

In 1999, the X-33 program experienced a setback when the composite materials used for its liquid-hydrogen fuel tank failed during testing. An investigation into the cause of the failure determined that the composite technology was not “mature enough” for such a use. Lockheed proposed to replace the composite tanks with aluminum tanks, which NASA agreed to if Lockheed could obtain Space Launch Initiative funding. However, it was determined that the benefit did not justify the cost, and NASA canceled the program in 2001 before proceeding to the next phase.⁴⁷² NASA’s investment in the X-33 program totaled \$912 million, staying within its 1996 budget projection for the program. Lockheed Martin originally committed to invest \$220 million in the X-33, and during the life of the program it increased that amount to \$357 million. In response to the cancellation, Lockheed chose not to continue developing the VentureStar. A criticism of both the X-34 and X-33 programs was that NASA had not prepared risk management plans until well after the programs had begun.⁴⁷³ According to U.S. General Accounting Office (GAO) testimony before the House Committee on Science, Subcommittee on

⁴⁷⁰ Ibid.

⁴⁷¹ Office of Inspector General, National Aeronautics and Space Administration, “Audit Report: X-33 Cost Estimating Processes,” IG-99-052, 24 September 1999, pp. i–ii, <http://oig.nasa.gov/audits/reports/FY99/pdfs/ig-99-052.pdf> (accessed 4 June 2007).

⁴⁷² Leonard David, “NASA Shuts Down X-33, X-34 Programs,” *Space.com*, http://www.space.com/missionlaunches/missions/x33_cancel_010301.html (accessed 22 March 2005).

⁴⁷³ U.S. General Accounting Office, Statement of Allen Li, director, Acquisition and Sourcing Management “Space Transportation: Critical Areas NASA Needs to Address in Managing Its Reusable Launch Vehicle Program,” GAO-01-826T, 20 June 2001, p. 5, <http://www.gao.gov/new.items/d01826t.pdf> (accessed 13 February 2007).

Space and Aeronautics, “a risk management plan for the X-34 was not developed until the program was restructured in June 2000. Although Lockheed Martin developed a plan to manage technical risks as part of its 1996 cooperative agreement for the X-33, NASA did not develop its own risk management plan for unique NASA risks until February 2000.” Furthermore, the GAO found that “NASA’s risk mitigation plan for the X-33 program provided no mechanisms for ensuring the completion of the program if significant cost growth occurred and/or the business case motivating industry participation weakened substantially.”⁴⁷⁴

Transportation Technology Support

Another advanced space transportation focus was transportation technology support. Activities in this area supported efforts to reduce the cost and improve the reliability, operability, responsiveness, and safety of ELVs, solid rocket motors, spacecraft propulsion systems, and launch operations. Programs included ELV cooperative tasks, operations/software technologies, the Solid Propulsion Integrity Program (SPIP), in-space transportation, and engineering capability development. In most cases, government and industry shared the costs for these programs.

In 1994, the ELV program worked in cooperation with industry on several aluminum-lithium cryogenic tank projects. A low-cost extrusion process was developed to fabricate net-shaped (0.3-inch/7.6-millimeter thickness) aluminum-lithium wall panel sections for a 14-foot (4.3-meter)-diameter ground-test article representative of an upper-stage cryotank. Aluminum-lithium weld properties were optimized and automated welding was developed with real-time, closed-loop process control. An additional cooperative ELV accomplishment was the qualification of a

⁴⁷⁴ GAO “Space Transportation: Critical Areas NASA Needs To Address in Managing Its Reusable Launch Vehicle Program,” p. 5, <http://www.gao.gov/new.items/d01826t.pdf>. Also “X-33,” GlobalSecurity.org, <http://www.globalsecurity.org/space/systems/x-33.htm> (accessed 13 February 2007).

60-horsepower, quadruple-redundant, electromechanical actuator (EMA) in the load simulator at Marshall Space Flight Center.⁴⁷⁵ In FY 1995, the program completed the fabrication of low-cost aluminum-lithium components and a ground-test rig for the Lockheed-Martin 14-foot (4.3-meter)-diameter cryogenic tank tests. The team used the Lockheed-Martin Integrated Fault Tolerant Avionics Facility to begin developing a stand-alone, redundant EMA system to meet Atlas booster requirements. Additionally, SSME diagnostic systems for use on the SSME testbed at Marshall, as well as trending-technique algorithms developed by Lewis Research Center, were applied to the development of an automated propulsion diagnostic system for ground checkout of the Atlas booster.⁴⁷⁶

In FY 1995, the Spacecraft Systems Technology program completed a 2-kilowatt (of electric power) solar dynamic ground-test demonstration, the first end-to-end demonstration of a complete solar dynamic power system designed for space operations. The system performed as designed under conditions simulating the thermal and vacuum environment of low-Earth orbit. In addition, Lockheed Martin adopted for commercial use a NASA-developed advanced arcjet spacecraft propulsion system that used significantly less propellant.⁴⁷⁷

The purpose of the Solid Propulsion Integrity Program (SPIP) was to improve the engineering needed to increase the success rate of U.S.-built solid rocket motors, mitigate and manage the motors' risk, and enhance the economic competitiveness of the solid-rocket-motor industry. The

⁴⁷⁵ "Advanced Space Transportation," Office of Space Access and Technology Fiscal Year 1996 Estimates, p. SAT 5-10.

⁴⁷⁶ "Advanced Space Transportation," Office of Space Access and Technology Fiscal Year 1997 Estimates, p. SAT 5-11.

⁴⁷⁷ *Aeronautics and Space Report of the President, Fiscal Year 1995 Activities*, p. 30. Also "Spacecraft and Remote Sensing," Office of Space Access and Technology Fiscal Year 1997 Estimates, p. SAT 5-21.

program's strategy was to establish government-industry teams to resolve uncertainties within the industry by means of science and engineering, and to make science and engineering available to solid-rocket-motor designers, manufacturers, verifiers, and users nationwide. NASA was the lead agency; the DOD provided tests, facilities, and expert personnel at minimal costs to the SPIP; and industry contributed independent research and development products, as well as expert skills and experience.

The In-Space Transportation Technology Development program developed and demonstrated major technological advances in very-high-performance spacecraft propulsion systems to reduce launch costs and increase the life and useful payload capability of commercial, scientific, and military spacecraft. The major focus of this cooperative work was to integrate innovative power and propulsion systems, particularly on small, low-power spacecraft. This would reduce propulsion system size and weight requirements and shrink the size of the spacecraft and its launch vehicle while maintaining or enhancing the life and payload capability of the satellite. This program also included development of automated rendezvous and capture technologies that would enable uncrewed vehicles to service in-space assets or resupply the space station.

Lewis Research Center was participating in several ongoing cooperative efforts with spacecraft developers and users, as well as advanced propulsion system manufacturers. Accomplishments in 1994 included the successful use of NASA-developed arc-jet thrusters to keep the commercial Telstar 4 satellite on station. This first-generation arc-jet system was based on a commercial communications satellite. Additionally, a qualification-level demonstration of a higher-performance, 600-second specific impulse arc jet was completed under a NASA-industry

program and accepted for the next-generation geostationary satellite series.⁴⁷⁸ In 1995, solar electric flight systems design and ground tests took place.⁴⁷⁹ In FY 1996, the major project was the NSTAR (NASA Solar Electric Propulsion Technology Application Readiness) ion propulsion system to be used on the New Millennium Deep Space-1 mission.⁴⁸⁰

Operations

The objective of the Operations Technology program, which began in FY 1991, was to develop and demonstrate technologies to reduce the cost of NASA operations, improve their safety and reliability, and permit new, more complex activities to be undertaken with robust and flexible support systems. Directed toward improving operations of both spacecraft and ground systems, it sought to develop technologies that would significantly benefit all of the Agency's major operational areas and support the U.S. commercial satellite industry.

The program encompassed artificial intelligence applications to reduce direct dependence on human operators. It also supported advanced data analysis and retrieval technologies to improve the return and extraction of both science data and operating performance data containing critical information on spacecraft health. In FY 1991, in the areas of automation and robotics, advances were made in real-time data systems and automated structural assembly. The introduction of state-of-the-art techniques in expert systems, software engineering, human-computer interfaces, and distributed systems improved the quality of flight decision-making and the cost-effectiveness of Space Shuttle mission control operations. The goal of the real-time data system was to

⁴⁷⁸ "Advanced Space Transportation," Office of Space Access and Technology Fiscal Year 1996 Estimates, pp. SAT 5-11 – SAT 5-12.

⁴⁷⁹ "Advanced Space Transportation," Office of Space Access and Technology Fiscal Year 1997 Estimates, p. SAT 5-11.

⁴⁸⁰ "Advanced Space Transportation," Office of Aeronautics and Space Transportation Technology Fiscal Year 1998 Estimates, p. SAT 4.2-6.

relegate repetitive, monotonous monitoring tasks in mission control to automated systems and free the flight controller to concentrate on more challenging tasks, such as schedule modifications and trouble-shooting. In FY 1991, Johnson Space Center added a number of real-time expert systems to its Mission Control Center (MCC) consoles, resulting in improved data monitoring and the ability to more thoroughly analyze fault data in shorter time periods. The acquisition of real-time telemetry also permitted an animated view of the position of the Space Shuttle's remote manipulator system. The new data system both lessened the flight controller's workload and allowed the controller to view and thus prevent collisions between the Shuttle and payloads. In FY 1994, the Extreme Ultraviolet Explorer (EUVE) Mission Operations Office validated automated monitoring technology developed by the Operations program to reduce total spacecraft operator hours by 60 percent.⁴⁸¹

Automated assembly of large space structures was also demonstrated. In FY 1991, complete assembly and disassembly of a 102-piece truss took place in a supervised autonomous, computer control mode. The system's reliability was good, and the test monitor successfully corrected most operational errors.⁴⁸²

In FY 1995, the JPL developed an artificial-intelligence application called JARTOOL that searched massive image databases and discovered phenomena of interest using an adaptive pattern recognition system. JARTOOL discovered 10 quasars during that year in a small fraction of the time it would have taken humans analyzing the data, at a much lower cost. The JPL also developed a tool called the Multimission VICAR Planner (MVP) to automate the planning

⁴⁸¹ "Spacecraft and Remote Sensing," Office of Space Access and Technology, Fiscal Year 1996 Estimates, p. SAT 5-21.

⁴⁸² *Aeronautics and Space Report of the President, Fiscal Year 1991 Activities*, pp. 64–65.

procedure for image processing. This planner was selected for use by the Galileo Project Office. It reduced the time needed for an expert to develop an image-processing plan from 4 hours to 15 minutes.⁴⁸³

Operations and support efforts to enhance existing launch systems in FY 1994 included the development of an automated scheduling system for Space Shuttle orbiter processing at Kennedy Space Center. Shuttle software verification was also automated at Johnson Space Center, and researchers continued to improve the automated diagnostic capabilities of the Johnson MCC by applying diagnostic expert systems and pattern recognition techniques to automatically scan strip charts and raw telemetry.⁴⁸⁴ During FY 1995, the activity at Kennedy expanded from the Orbiter Processing Facility to the Vehicle Assembly Building and the launch pads. The Johnson MCC also initiated an electronic documentation system to eliminate millions of photocopy pages and streamline change processes.⁴⁸⁵

In FY 1995, NASA addressed the challenge of reducing mission costs without reducing performance and payoffs by focusing technology development on

- reducing the mass and increasing the efficiency of spacecraft systems to enable the use of smaller launch vehicles;
- increasing spacecraft and ground system autonomy to reduce the overall mission operations cost;

⁴⁸³ “Spacecraft and Remote Sensing,” Office of Space Access and Technology, Fiscal Year 1997 Estimates, p. SAT 5-23.

⁴⁸⁴ “Advanced Space Transportation,” Office of Space Access and Technology Fiscal Year 1996 Estimates, p. SAT 5-10.

⁴⁸⁵ “Advanced Space Transportation,” Office of Space Access and Technology Fiscal Year 1997 Estimates, p. SAT 5-11.

- exploiting microfabrication technology to develop miniaturized components and instruments with equal or better performance than current components and instruments.⁴⁸⁶

Communications

Space communications consisted of four major program elements:

- Near-Earth communications systems explored radio frequency (RF), digital, and mobile communications systems in support of the commercial space communications industry and NASA's MTPE.
- The deep-space communications element developed technologies primarily to meet the needs of special NASA missions that were not supported by near-Earth communications, including planetary exploration and astrophysics.
- Space terrestrial hybrid systems investigated the space communications portion of hybrid satellite/terrestrial systems, such as the National Information Infrastructure.
- The applications experiments element supported the Advanced Communications Technology Satellite (ACTS) experiment program, including operation of the spacecraft (launched in September 1993) and its ground network and experiment development.⁴⁸⁷

By the end of FY 1995, the program had completed a large number of ACTS experiments. Some of the most significant experiments demonstrated high data rate transmission via satellite or were in the areas of telemedicine or tele-education. The program demonstrated the feasibility of 20-gigahertz system-level integrated circuit (SLIC)/monolithic microwave integrated circuit

⁴⁸⁶ *Aeronautics and Space Report of the President, Fiscal Year 1995 Activities*, p. 25.

⁴⁸⁷ "Spacecraft and Remote Sensing," Office of Space Access and Technology, Fiscal Year 1996 Estimates, Budget Summary, Spacecraft and Remote Sensing, p. SAT 5-14.

(MMIC) antenna systems. In addition, the digital portion of the program completed development of a very high data rate modem.⁴⁸⁸ (See chapter 2 for more information about ACTS.)

Breakthrough Technologies

The purpose of the Breakthrough Technologies program was to advance high-payoff, highly innovative technology concepts that could provide significant advances in the approach to future space missions and programs. During 1989 and 1990, a computer program called AUTOCLASS was demonstrated. It used artificial-intelligence techniques to automatically classify data. Its benefit was that it could automatically discover patterns in very large data sets. Researchers achieved dramatic results by analyzing results from the Infrared Astronomy Satellite (IRAS) through the automatic discovery of several unexpected data patterns. Several new versions of the software were released throughout the 1990s. In mid-1998, the public domain C version of AUTOCLASS reached maturity.⁴⁸⁹

The Sparse Distributed Memory program was successfully completed with the demonstration of shape, speech, and text translators. This associative memory with massively parallel architecture provided an extremely large address space and enabled information to be structured, filtered, and linked to other stored information in the process of storing data. Based on an effort to understand human long-term memory, it was capable of abstraction and generalization, and formed the basis for future autonomous systems that could learn from experience. Such systems could then provide artificial-intelligence capabilities for tasks that would be too remote, too hostile, or too tedious for humans.⁴⁹⁰

⁴⁸⁸ Ibid., p. SAT 5-20.

⁴⁸⁹ “The AutoClass Project,” <http://ic.arc.nasa.gov/ic/projects/bayes-group/autoclass/index.html> (accessed 26 August 2006).

⁴⁹⁰ *Aeronautics and Space Report of the President, 1989–1990 Activities*, pp. 56–57.

Advanced Smallsat Technology

In early 1994, NASA began the Advanced Small Satellite (Smallsat) Technology program, an element of the Small Satellite Technology Initiative and part of the Agency's "faster, better, cheaper" approach. This technology demonstration program's principal objective was to change the way NASA designed, built, launched, and operated small spacecraft for scientific missions and commercial activities in space.⁴⁹¹ Its major goals were to

- demonstrate how to reduce the cost and development time of space missions for science and commercial applications;
- demonstrate new design and qualification methods for small spacecraft, including the use of commercial and performance-based specifications, and integration of small instrumentation technology into a bus design;
- proactively promote commercial technology applications.⁴⁹²

NASA chose a two-satellite project, called Lewis and Clark, to demonstrate a number of new technologies as well as NASA's new way of managing projects.⁴⁹³ The small satellites were designed to accommodate a wide range of missions through the use of standard hardware and software adapted to various applications. In June and July 1994, NASA selected two industry teams (CTA Inc. of Rockville, Maryland, for Clark, and TRW Inc. of Redondo Beach, California, for Lewis) to design, develop, produce, and launch two advanced experimental smallsats, or "lightsats," in the 600- to 900-pound (272- to 408-kilogram) class. The entire contract process took only 70 days, as compared to the typical six months to one year. In

⁴⁹¹ Howard E. McCurdy, *Faster, Better, Cheaper: Low-Cost Innovation in the U.S. Space Program* (Baltimore, MD: Johns Hopkins University Press, 2001), pp. 5–7.

⁴⁹² "Advanced Smallsat Technology," Office of Space Access and Technology, Fiscal Year 1996 Estimates, p. SAT 5-22.

⁴⁹³ McCurdy, pp. 5–7.

addition to their primary instruments, both spacecraft were to carry additional instruments to provide information on the dynamics of global atmospheric pollution for the MTPE program.⁴⁹⁴ Systems integration work was completed during FY 1995. Clark was targeted for a 1996 launch; Lewis was to follow in 1997.

Clark

Clark was to demonstrate more than 30 advanced technologies, including image data compression, a mini star tracker, a low-cost Sun sensor, advanced composite structures, room-temperature x-ray detectors, 3-D imaging of atmospheric trace gases, and on-board data processing. Its principal focus was to be on commercial remote sensing, and it was also to operate as a science and applications satellite with three science payloads and a remote sensing imaging system. Clark was to help city planners and developers evaluate sites and construction needs through the use of an optical element with very high spatial resolution and capabilities for stereo imaging. Science research was to include x-ray spectrometry, including atmospheric pollution measurements, cloud detection, and atmospheric tomography.⁴⁹⁵

The Clark mission's prime contractor, CTA, manufactured small space systems and had built, launched, and operated 21 lightsats, with several others in development. In July 1997, CTA sold its satellite division to Orbital Sciences, Inc. Martin Marietta Astronautics was to provide the Clark launch vehicle. In 1995, Martin Marietta merged with Lockheed Martin.⁴⁹⁶

⁴⁹⁴ *Aeronautics and Space Report of the President, Fiscal Year 1994 Activities*, p. 50.

⁴⁹⁵ "Small Satellite Developments," <http://www.sti.nasa.gov/tto/spinoff1996/17.html> (accessed 11 March 2006).

⁴⁹⁶ "NASA Terminates Clark Earth Science Mission," *NASA News Release 98-35*, 25 February 1998, <ftp://ftp.hq.nasa.gov/pub/pao/pressrel/1998/98-035.txt> (accessed 5 January 2006).

The project experienced cost overruns and delays. By late 1997, it was nearly two years behind schedule.⁴⁹⁷ In February 1998, NASA terminated the mission “due to mission costs, launch schedule delays, and concerns over the mission’s on-orbit capabilities.”⁴⁹⁸

Lewis

Lewis was the first space-based hyperspectral imaging system. It was considered widely applicable to Earth sciences and potentially valuable for new commercial business opportunities. Its advanced remote sensing imager was to significantly broaden the range of Earth features that could be analyzed from space.⁴⁹⁹ Part of NASA’s Small Spacecraft Technology Initiative, its two-year timetable from contract award to completion and relatively low cost of \$64.8 million were touted as a “marked improvement” over earlier satellites that took many more years to complete and cost “hundreds of millions of dollars or more.”⁵⁰⁰ The 890-pound (404-kilogram) satellite, built by TRW Space & Electronics Group, launched on 22 August 1997 from Vandenberg Air Force Base on a Pegasus XL launch vehicle.⁵⁰¹

On August 26, four days after its successful launch, the satellite entered a spin that disrupted its power-generating capability. The solar arrays were unable to generate full power due to the spinning motion, and the batteries were discharged below operational levels. Repeated attempts

⁴⁹⁷ McCurdy, p. 58.

⁴⁹⁸ “NASA Terminates Clark Earth Science Mission,” *NASA News Release* 98-35, 25 February 1998.

⁴⁹⁹ “Small Satellite Developments.” Launch occurred at 11:51 p.m. Pacific Daylight Time, 22 August 1997. This was 2:51 a.m., 23 August 1997, Eastern Daylight Time.

⁵⁰⁰ “NASA, TRW Ready Lewis Mission for Launch on Second LMLV Rocket,” *Space Business News* 15, no. 15 (23 July 1997): p. 1, NASA History Division folder 16023, Historical Reference Collection, NASA Headquarters, Washington, DC.

⁵⁰¹ At the time of launch, Lewis was part of the MTPE enterprise. “Attempts To Contact Lewis Spacecraft Unsuccessful; Re-entry Likely Next Week,” *NASA News Release* 97-208, 19 September 1997, <ftp://ftp.hq.nasa.gov/pub/pao/pressrel/1997/97-208.txt> (accessed 10 March 2006).

to reestablish radio contact failed, and increasing atmospheric drag deteriorated the spacecraft's orbit until it reentered Earth's atmosphere on September 28 and burned up.⁵⁰²

An independent failure investigation board was established immediately after the spacecraft was lost. The board attributed the failure to a technically flawed Attitude Control System (ACS) design and simulation, combined with insufficient monitoring of the spacecraft. TRW had adapted the design of the ACS from the system on the Total Ozone Monitoring Spectrometer-Earth Probe (TOMS-EP) spacecraft. The failure board found that the TOMS ACS was adapted without sufficient consideration for Lewis' different primary spacecraft spin-axis orientation. Additionally, the board described as "flawed" the assumption that a small crew could monitor and operate Lewis with the aid of an autonomous safehold mode, even during the initial operations period. This prevented timely recognition that the satellite had begun to tumble.⁵⁰³ The investigation board also considered the role of the "faster, better, cheaper" concept. The board stated that although "this paradigm [could] be successfully implemented with sound engineering and attentive and effective management," in the case of Lewis, the program skipped "typical government oversight functions."⁵⁰⁴ It made several recommendations reinforcing "the importance of scrupulous attention to detail, rigorous test process application, and the role of independent audits with engineering discipline . . ." to ensure mission success.⁵⁰⁵

⁵⁰² "Lewis Spacecraft Encounters Difficulties," *NASA News Release 97-182*, 26 August 1997, <ftp://ftp.hq.nasa.gov/pub/pao/pressrel/1997/97-182.txt> (accessed 27 June 2006). Also "Attempts To Contact Lewis Spacecraft Unsuccessful; Re-entry Likely Next Week," *NASA News Release 97-208*, 19 September 1997, <ftp://ftp.hq.nasa.gov/pub/pao/pressrel/1997/97-208.txt> (accessed 10 March 2006).

⁵⁰³ "Lewis Spacecraft Failure Board Report Released," *NASA News Release 98-109*, 23 June 1998, <ftp://ftp.hq.nasa.gov/pub/pao/pressrel/1998/98-109.txt> (accessed 10 March 2006).

⁵⁰⁴ "Lewis Spacecraft Mission Failure Investigation Board, Final Report," pp. 1-2, 12 February 1998, NASA History Division folder 16023, Historical Reference Collection, NASA Headquarters, Washington, DC.

⁵⁰⁵ "Lewis Spacecraft Mission Failure Investigation Board, Final Report," p. 19, 12 February 1998, NASA History Division folder 16023, Historical Reference Collection, NASA Headquarters, Washington, DC.

Advanced Concepts Office

In FY 1995, the Office of Space Access and Technology formed the Advanced Concepts Office to identify and develop new, far-reaching concepts that might later be applied to advanced technology programs. The office initiated a wide-ranging program of feasibility studies and experiments in areas such as affordable in-space transportation, space solar power, highly reusable space transportation, very large and lightweight adaptive optics, orbital debris removal, International Space Station downmass disposal using tethers, structureless cooperating space swarms, and very large, lightweight, structureless antennas. The office also formulated a process for advanced concept creation, external to NASA, and issued an initial solicitation for the Advanced Concepts Research Projects program. It also defined a potential process for competitive creation of innovative concepts by NASA inventors. NASA also created the Virtual Research Center concept, which involved a dedicated collaborative computing environment for NASA advanced concepts studies.⁵⁰⁶

Space Shuttle Technology

The Space Shuttle often served as an in-space laboratory to test basic R&T concepts and validate technology in the space environment. NASA used the Shuttle as an experimental facility for research in aerodynamics, TPSs, and the payload environment. From the beginning of the Shuttle program, NASA had conducted orbiter experiments to collect data about the orbiter's performance. During this decade, In-STEP experiments and a dedicated aeronautics and space technology mission took place on the Shuttle. In addition, the Spartan program sponsored technology development missions, and various technology experiments as part of larger on-board payloads.

⁵⁰⁶ *Aeronautics and Space Report of the President, Fiscal Year 1995 Activities*, p. 32.

In-STEP Experiments

In July 1991, the Tank Pressure Control Experiment rode aboard Space Shuttle *Atlantis* on the STS-43 mission. This In-STEP project demonstrated a method for controlling cryogenic storage tank pressures by actively mixing the fluids to eliminate temperature stratification. In September 1991, the first university flight experiment supported by In-STEP flew aboard the Space Shuttle on the STS-48 mission. Known as MODE (for Middeck 0-Gravity Dynamics Experiment), the project flight-tested the influence of zero gravity on the sloshing behavior of fluid in a tank and the vibration characteristics of truss structures in space.⁵⁰⁷ A reflight of MODE took place in 1994 aboard STS-60. The experiment successfully predicted the dynamics of the truss structure and captured all planned data. OAST-2, also on STS-60, included six In-STEP experiments (see description below).

OAST-2

OAST-2 was a Hitchhiker cross-bay carrier mission that was mounted in Space Shuttle *Columbia*'s cargo bay and shared the area with the U.S. Microgravity Payload-2 mission. It was carried on the STS-62 14-day extended-duration mission launched on 4 March 1994. OAST-2 consisted of six In-STEP experiments sponsored by OACT. The In-STEP objectives of these experiments, which operated in microgravity, were to evaluate and validate space technologies, and gain a better understanding of the effects of microgravity and the space environment on spacecraft.⁵⁰⁸

⁵⁰⁷ *Aeronautics and Space Report of the President, Fiscal Year 1991 Activities*, p. 66. Also "STS-48 Press Kit," September 1991, p. 33, http://www.jsc.nasa.gov/history/shuttle_pk/pk/Flight_043_STS-048_Press_Kit.pdf (accessed 10 June 2006).

⁵⁰⁸ "STS-62," March 1994, p. 23, NASA History Division folder 11035, Historical Reference Collection, NASA Headquarters, Washington, DC.

Four of the OAST experiments—Solar Array Module Plasma Interaction Experiment (SAMPIE), Experimental Investigation of Spacecraft Glow (EISG), Spacecraft Kinetic InfraRed Test (SKIRT), and Emulsion Chamber Technology (ECT)—investigated aspects of the spacecraft’s space–environmental interaction in low-Earth orbit. The remaining two experiments—Thermal Energy Storage (TES) and CRYogenic Two Phase (CRYOTP)—investigated the performance of selected thermal storage and thermal control technologies (see table 3-41).⁵⁰⁹ These experiments showed that the release of nitrogen gas decreases the intensity of spacecraft glow in the visible and far ultraviolet spectrums, enhanced understanding of the interaction of high-voltage surfaces in space, demonstrated the use of phase-change material for thermal energy storage, and measured cosmic background radiation with the extreme accuracy needed to deduce its origins.⁵¹⁰

The Spartan Program

The Spartan program evolved from NASA’s sounding-rocket program and provided a series of low-cost, reusable, free-flying space platforms for various scientific and technological studies. It was conceived in the late 1970s to take advantage of the increased observation time provided by the Space Shuttle (compared to the 5–10 minutes allowed by sounding-rocket flights) for increasingly sophisticated experiments.⁵¹¹ Spartans carried a variety of scientific instruments and offered the scientific community the capability to conduct investigations in space between those offered by small payloads remaining in the orbiter and larger satellites orbiting Earth for long periods of time.

⁵⁰⁹ “OAST-2 Prelaunch Mission Operation Report,” Office of Advanced Concepts and Technology, Report No. C-237-94-62-01, NASA History Division folder 11034, Historical Reference Collection, NASA Headquarters, Washington, DC.

⁵¹⁰ “Flight Programs,” Office of Space Access and Technology, Fiscal Year 1996 Estimates, p. SAT 5-32.

⁵¹¹ “Spartan 201-5,” Payloads STS-95, <http://www.shuttlepresskit.com/STS-95/payload9.htm> (accessed 25 August 2005).

Spartan satellites were launched aboard the Space Shuttle and deployed from the orbiter, where they performed preprogrammed missions. Scientific data were collected during each mission and recorded with the use of a tape recorder and, in many cases, film cameras. There was no command and control capability after deployment; batteries provided power, and attitude control was accomplished with pneumatic gas jets. The three-axis stabilized spacecraft weighed 1,300 kilograms (2,866 pounds), with 500 kilograms (1,102 pounds) allotted to experiments. Its operational mission usually lasted about 45 hours. At the end of its mission, the Spartan was retrieved by the orbiter and returned to Earth for recovery of the data, refurbishment, and preparation for future missions.⁵¹²

Most of Spartan's primary payloads related to solar physics.⁵¹³ The OAST-Flyer (also called Spartan 206) and Spartan 207 were Spartan technology missions.

OAST-Flyer. Space Shuttle mission STS-72 deployed and retrieved the OAST-Flyer spacecraft, the seventh in a series of missions that used reusable, free-flying Spartan carriers. The OAST-Flyer, in its Spartan carrier, was deployed from the Shuttle on 14 January 1996, the fourth day of the mission, and retrieved on the sixth day of the mission by the Shuttle's robot arm.⁵¹⁴ The satellite operated about 45 nautical miles (83 kilometers) from *Endeavour* during its two days of free flight.

⁵¹² "Spartan 201-01," NSSDC Master Catalogue: Spacecraft, <http://nssdc.gsfc.nasa.gov/database/MasterCatalog?sc=1993-023B> (accessed 25 August 2005).

⁵¹³ See chapter 4 in volume VII of the *NASA Historical Data Book, 1989–1998*, for a discussion of Spartan solar physics and astronomy missions.

⁵¹⁴ "STS-72 Day 4 Highlights," <http://science.ksc.nasa.gov/shuttle/missions/sts-72/sts-72-day-04-highlights.html>. Also "STS-72 Day 6 Highlights," <http://science.ksc.nasa.gov/shuttle/missions/sts-72/sts-72-day-06-highlights.html> (both accessed 13 February 2006).

The 2,600-pound (1,179-kilogram) OAST-Flyer carried four experiments: the Return Flux Experiment (REFLEX), the Global Positioning System (GPS) Attitude Determination and Control Experiment (GADACS), the Solar Exposure to Laser Ordnance Device (SELODE), and the Spartan Packet Radio Experiment (SPRE). GADACS and REFLEX were sponsored by NASA's Office of Space Access and Technology (OSAT). SELODE was sponsored by NASA's Office of Safety and Mission Assurance (OSMA).⁵¹⁵ The fourth experiment, SPRE, was a volunteer effort by students from the University of Maryland, area engineers, and space industry contractors.⁵¹⁶ Mounted on the rectangular Spartan structure, the experiments studied spacecraft contamination, the use of the GPS for spacecraft attitude control, and laser-initiated pyrotechnic devices in the environment of space. The amateur radio experiment allowed radio operators on the ground to track the satellite.

REFLEX was a technology experiment designed to determine the accuracy of the computer-generated models that helped determine how contaminated a spacecraft might become. The main objective of REFLEX was to investigate molecular backscattering, or "return flux," associated with on-orbit spacecraft. This phenomenon occurs when spacecraft give off tiny particles of dirt into the atmosphere that then collide with other particles and bounce back to the spacecraft. This dirt could cause spacecraft systems to fail. Return flux was believed to be one of the factors that scientists had been unable to calculate into their computer-generated models. REFLEX also

⁵¹⁵ "Space Shuttle Mission STS-72 Press Kit," January 1996, <http://science.ksc.nasa.gov/shuttle/missions/sts-72/sts-72-press-kit.txt> (accessed 28 June 2006).

⁵¹⁶ "OAST-Flyer," Goddard Space Flight Center Photos, www.gsfc.nasa.gov/indepth/photos_spaceearly.html (accessed 13 February 2006).

studied the erosion of spacecraft surface coatings as a result of particles chemically reacting with the atmosphere.⁵¹⁷

GADACS demonstrated the use of GPS technology in space to determine the attitude, location, and velocity of the Spartan spacecraft, and provide accurate timing for one portion of the Spartan mission. GADACS used GPS data to calculate Spartan's orientation, and fire thrusters to point the spacecraft in different directions. This was the first time a spacecraft had been controlled using the GPS. The technology could lead to redesigned spacecraft and lighter, less costly missions in the future.

SELODE tested the safety and reliability of different types of laser ordnance devices. The primary investigation centered on the effects of direct and concentrated sunlight in space on different explosives and design methods. Flight tests evaluated accidental firing levels, while postflight tests examined the effects of exposure on the chemical stability of the explosives. Pyrotechnic devices are used in numerous applications on space vehicles, such as the use of explosive bolts and nuts to separate the Space Shuttle orbiter from the external tank. Most pyrotechnic devices are fired with electricity, but stray electrical energy sources (e.g., radio transmitter signals or static electricity) may cause accidental firing. SELODE used a laser pulse traveling through a fiber-optic cable to trigger an explosive charge in a new type of pyrotechnic device that could eliminate the risk of accidental firing due to stray electrical energy sources.⁵¹⁸

⁵¹⁷ "Space Shuttle Mission STS-72 Press Kit," January 1996, p. 15, http://www.jsc.nasa.gov/history/shuttle_pk/pk/Flight_074_STS-072_Press_Kit.pdf (accessed 28 June 2006).

⁵¹⁸ Ibid., p. 17.

SPRE was an amateur radio communications experiment. Its primary goal was to test satellite tracking using an amateur packet radio and the GPS. Although the Spartan carrier normally did not communicate with the ground or the Shuttle on orbit, SPRE was tested as a way to communicate with the REFLEX experiment.⁵¹⁹ SPRE ground stations used special software called APRtrak™ to plot the positions of stations and objects worldwide using SPRE transmissions. APRtrak used full color maps and graphics that could display detailed maps of selected regions. Amateur radio ground stations transmitted their locations to SPRE and when the transmission was heard, SPRE relayed the GPS information to Earth. All ground stations within range of SPRE saw the relayed stations plotted on the map at the correct geographic location. The APRtrak software also decoded and displayed SPRE housekeeping telemetry, such as temperatures, voltages, and system status. SPRE participants included amateur radio operators throughout the world. Elementary and high schools were encouraged to enlist the aid of local amateur radio operators to set up ground stations and participate in the SPRE experiment. Participating amateurs and schools were encouraged to send the data they collected to the SPRE project to help piece together a composite picture of the mission. SPRE used a ground control network, SPREnet, that consisted of specially equipped amateur radio stations to distribute data via the Internet. These control stations successfully monitored the health and activity of SPRE.

In addition to the amateur radio experiment, SPRE forwarded to Earth a sampling of real-time telemetry for the REFLEX and GADACS experiments. Spartans were equipped with on-board recorders to capture data from each of the experiments. Traditionally, an experimenter must wait

⁵¹⁹ “STS-72 Endeavour OAST-Flyer/Space Flyer Unit (SFU),” KSC Release No. 132-95, December 1995, <http://www-pao.ksc.nasa.gov/kscpao/nasafact/72facts2.htm> (accessed 10 February 2006).

several weeks to receive any mission data. SPRE gave experimenters the opportunity to view a small sample of data during the mission while advancing amateur radio satellite technology.⁵²⁰

Spartan 207. Space Shuttle mission STS-77 launched on 19 May 1996, carrying the Spartan 207 spacecraft. The mission deployed and tested the Inflatable Antenna Experiment (IAE), which helped lay the groundwork for future technological developments in inflatable space structures that can be launched in a compact form and then inflated once in orbit. Spartan 207/IAE validated the deployment (inflation) and performance of a large inflatable antenna during its 90-minute mission.⁵²¹

The Spartan payload consisted of the Spartan Free-Flyer Spacecraft and Inflatable experiment and the Spartan Flight Support Structure (SFSS), which held the Spartan spacecraft in the Space Shuttle's cargo bay. The IAE, developed by L'Garde Inc., of Tustin, California, and NASA's JPL, was an inflatable 50-foot (14-meter)-diameter antenna mounted on three 92-foot (28-meter) struts that were attached to the Spartan spacecraft. Before the antenna was inflated, the Spartan spacecraft was rectangular in shape. The IAE weighed 132 pounds (60 kilograms) and occupied about half the volume; the support systems occupied the remainder of the space. Once in orbit, the Spartan became a platform for the antenna that inflated in space into a 40-foot-diameter, 92-foot-long structure.⁵²² After inflation, an optical system surveyed the antenna and measured the accuracy of the surface under a variety of internal pressures and thermal conditions. Figure 3-59 shows the Spartan and the inflated antenna.

⁵²⁰ "Spartan Packet Radio Experiment (SPRE)," Amateur Radio Association at the University of Maryland W3EAX, <http://w3eax.umd.edu/spre/spre.html> (accessed 28 June 2006).

⁵²¹ "STS-77," <http://science.ksc.nasa.gov/shuttle/missions/sts-77/mission-sts-77.html> (accessed 10 February 2006).

⁵²² "Space Technology Development," <http://www.sti.nasa.gov/tto/spinoff1996/13.html> (accessed 10 February 2006). Also telephone conversation with Mark Steiner, Spartan Mission Manager, 10 February 2006).

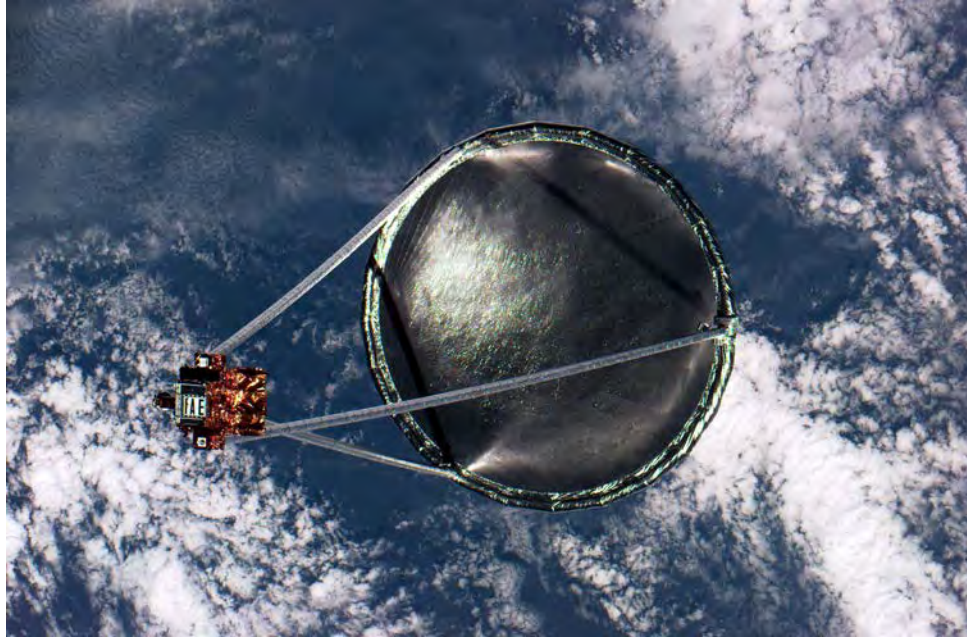

Figure 3-59. Spartan 207 and the Inflatable C100 Antenna Experiment, 20 May 1996 (GSFC photo S77E5021).

The SFSS had three assemblies: the main, across-the-bay support structure known as the Mission Peculiar Equipment Support Structure (MPESS); the Release Engage Mechanism (REM); and the interface hardware between the MPESS and REM known as the Mission Peculiar Equipment (MPE). The SFSS attached to the payload bay by means of keel and sill trunnion fittings. The REM interface allowed the SP207/IAE to be attached to and detached from the SFSS.⁵²³

Spartan was released from the Space Shuttle on 20 May. The antenna was successfully deployed and it achieved the proper configuration. During the initial ejection and inflation, the IAE experienced unexpected dynamics, but the correct final shape was attained. After the antenna structure was fully inflated, the spacecraft began to rotate unexpectedly. The rotation ceased later

⁵²³ "Spartan 207 Mission," <http://www.lgarde.com/gsf/207.htm> (accessed 4 June 2007).

in the orbit.⁵²⁴ The inflation process was captured by the STS-77 crew on still, motion-picture, and video cameras. For postmission analysis of the inflatable structure's performance, the antenna surface was illuminated by arrays of lights mounted on the Spartan satellite, and the resulting patterns were acquired by Spartan's video recorders. After 90 minutes of operation, the IAE was jettisoned; the Spartan was grappled and retrieved the following day.⁵²⁵

Space Processing

The Space Processing program provided the required access to experiment facilities, and frequent access to space using the Shuttle middeck, SPACEHAB, Spacelab, and Wake Shield facilities. Through cost-sharing partnerships between NASA, universities, and industry, private enterprises could afford to perform important research to develop space-linked commercial products that otherwise would be prohibitively expensive. In FY 1994, the Space Processing program completed 24 flight experiments using Shuttle middeck lockers, SPACEHAB, and the first flight of the Wake Shield Facility. These experiments provided information for technological developments in several industrial areas, including pharmaceuticals, medical devices, agriculture, ceramics, and metallurgy. In one such experiment, researchers used the growth of crystals in space to characterize alpha-interferon and Factor D, which could result in advanced drugs.⁵²⁶ In FY 1995, the program manifested payloads on five of six Shuttle flights. These payloads included 26 flight experiments that used Shuttle middeck lockers, SPACEHAB, and the second flight of the Wake Shield Facility. This flight demonstrated epitaxial crystal growth in free-flyer mode. The flights of SPACEHAB-2 and the U.S. Microgravity Laboratory-2

⁵²⁴ "Spartan 207/Inflatable Antenna Experiment Flown on STS-77, Preliminary Mission Report," Spartan Project, NASA Goddard Space Flight Center, 14 February 1997, pp. 1, 5, <http://www.lgarde.com/papers/iaeprelim/iaeprelim.htm> (accessed 4 June 2007).

⁵²⁵ "Space Technology Development," <http://www.sti.nasa.gov/tto/spinoff1996/13.html> (accessed 10 February 2006).

⁵²⁶ "Space Processing," Office of Space Access and Technology, Fiscal Year 1996 Estimates, pp. SAT 5-25–SAT 5-26.

included commercial experiments that involved protein crystal growth, metal sintering, physiological testing, fluids mixing, biomedical applications, zeolite crystal growth, and plant growth.⁵²⁷

Orbiter Experiments (OEX) Program

In October 1993, the OEX program was completed with the successful flight of the Orbiter Acceleration Research Experiment (OARE) accelerometer aboard STS-58. Beginning with STS-1, data collected over the years by 13 OEX experiments became an important source for improving orbiter performance. The data they supplied were used to validate models for designing future space transportation vehicles. The principal investigators for these experiments represented Langley Research Center, Ames Research Center, Johnson Space Center, and Goddard Space Flight Center. The OEX program included the following experiments:

1. Aerodynamic Coefficient Identification Package (ACIP)
2. Aerothermal Instrumentation Package (AIP)
3. Catalytic Surface Effects (CSE)
4. Data Flight Instrumentation Package (DFI)
5. Dynamic, Acoustic, and Thermal Environment Experiment (DATE)
6. High Resolution Accelerometer Package (HiRAP)
7. Infrared Imagery of Shuttle (IRIS)
8. Orbiter Acceleration Research Experiment (OARE)
9. Shuttle Entry Air Data System (SEADS)
10. Shuttle Infrared Leaside Temperature Sensing (SILTS)

⁵²⁷ "Space Processing," Office of Space Access and Technology, Fiscal Year 1997 Estimates, p. SAT 5-35

11. Shuttle Upper Atmosphere Mass Spectrometer (SUMS)

12. Technology Flight Instrumentation (TFI)

13. Tile Gap Heating Effects Experiment (TGH)

CHAPTER 4: TRACKING AND DATA ACQUISITION/SPACE OPERATIONS

Introduction

NASA's tracking and data acquisition and space operations activities during the decade from 1989 to 1998 provided vital support for all NASA flight projects and, on a reimbursable basis, selected projects of the DOD and other government agencies, commercial firms, and other countries and international organizations engaged in space research activities. This support, essential for achieving the objectives of all flight missions, included:

- Tracking to determine the position and trajectory of vehicles in space.
- Acquisition of science and space applications data from on-board experiments and sensors.
- Acquisition of engineering data on the performance of spacecraft and launch vehicle systems.
- Reception of television transmissions from space vehicles.
- Transmission of commands from ground facilities to the spacecraft.
- Facilitating voice communications to and from astronauts.
- Transfer of information between various ground facilities and control centers.
- Processing data acquired from launch vehicles and spacecraft.
- Supporting transfer of television and data between ground facilities by a commercial vendor.¹

This chapter describes NASA's tracking and data acquisition and operations activities. It includes a summary of the decade from 1979 to 1998, an overview of Agency programs from 1989 to 1998, a description of the management structure and personnel, budget information, and an account of specific activities in these areas. Note that, as in other chapters of this data book,

¹ "Mission Support, Research and Program Management," FY 1996 Estimates, http://www.hq.nasa.gov/office/budget/fy96/ms_3.html (accessed March 20, 2007). Also, review comments of chapter from David Harris, December 21, 2006.

units are always presented in the system used in the original source document (metric or English). The equivalent follows in parentheses.

The Last Decade Reviewed (1979–1988)

During the decade from 1979 to 1989, NASA carried out its tracking and data acquisition activities using three major types of support capabilities. The Spaceflight Tracking and Data Network (STDN), a worldwide network of NASA ground stations, supported low-Earth orbital missions. The Deep Space Network (DSN) supported planetary and interplanetary flight missions. DSN also supported, on a limited basis, geosynchronous and highly elliptical missions and low-Earth-orbit missions not compatible with the Tracking and Data Relay Satellite System (TDRSS). Since both STDN and DSN were served by facilities located on the ground, they were commonly referred to as the Ground Network (GN). The third major support capability, TDRSS and its supporting ground station at White Sands, New Mexico, made up the Space Network (SN). TDRSS supported low-Earth-orbital missions from geosynchronous orbit and reduced NASA's reliance on an extensive network of ground stations. The system was characterized by its unique ability to provide bidirectional high data rates as well as position information to moving objects in real time nearly anywhere around the globe. The satellites were the first designed to handle telecommunications services through three frequency bands: the S-, Ku-, and C-bands. The S-band and Ku-band were used by NASA. The C-band was a commercial frequency not used by NASA. It was placed on the first series of TDRSS spacecraft in an attempt at cost-sharing between NASA and the commercial sector. During this decade, TDRSS spacecraft could transmit and receive data and track a user spacecraft in low-Earth orbit for approximately 85 percent of an orbit.

Development of TDRSS began following a series of studies in the 1970s showing that a system of satellites in geosynchronous orbit operated from a single ground station could support NASA's Earth-orbiting science missions and the Space Shuttle better than ground-based tracking stations. NASA contracted with Western Union in 1976 for a leased system and arranged for financing through the Federal Financing Bank. A series of changes in contract partners led to sole ownership and operation of the system by Continental Telephone (Contel) in 1985, which continued to own and operate the system throughout the decade on a lease arrangement with NASA. TDRS-1 and TDRS-3 were successfully launched during the decade. TDRS-B was destroyed on the 1986 *Challenger* accident.²

NASA's GN stations were an essential component of Space Shuttle support. To provide reliable, continuous, and instantaneous communications support, NASA added new sites and upgraded some of its existing facilities and capabilities for the Shuttle test phase and early Shuttle flights. New sites for ultra high frequency (UHF) air-to-ground voice communications were added in Dakar, Senegal; Botswana; and Yarragadee, Australia. Shuttle-unique sites were also added in Florida, California, and New Mexico. Dakar was upgraded to S-band in 1982 to enable continuous telemetry data coverage between Bermuda and Hawai'i for all due-east launches, beginning with STS-4. This midpoint station allowed for the analysis of initial orbital maneuvering system burn data and provided for crew updates in case of an abort.³ The network for the early Shuttle flights consisted of 17 NASA ground stations and the NASA Communications Network (NASCOM) and extensive DOD support.

² TDRS-B would have received the designation of TDRS-2 after it achieved orbit. Because it did not, it was never called TDRS-2, and that designation was never given to another satellite.

³ "Tracking Stations: STDN's Final Years," <http://www.bfec.us/bfextxt8a.htm> (accessed March 26, 2007).

As TDRSS became operational at the end of the 1980s, NASA phased out several STDN ground stations. The facilities at Fairbanks, Alaska, were transferred to the National Oceanic and Atmospheric Administration (NOAA) in 1984. STDN relinquished ground stations in Goldstone, California; Madrid, Spain; and Canberra, Australia. The 85-foot (26-meter) antennas were transferred to the DSN sites to significantly reduce operating costs by combining operating resources. They continued operating and supporting the same types of missions, although they were operated by NASA's Jet Propulsion Laboratory (JPL) rather than by Goddard Space Flight Center (GSFC).⁴

In 1988, the DSN consisted of three complexes: Goldstone in southern California's Mojave Desert, near Madrid, and near Canberra. These complexes were approximately 120 degrees apart in longitude, ensuring continuous observation and suitable overlap for transferring a spacecraft's radio link from one complex to the next. Each complex consisted of at least four antennas. Equipment included 34-meter (111-foot)-diameter X- and S-band antennas that had been converted from 26-meter (85-foot) antennas in 1980, 26-meter (85-foot) antennas, and 70-meter (230-foot) antennas that had been extended from their original 64-meter (210-foot) diameters in preparation for the 1989 Voyager 2 spacecraft encounter with Neptune. For the Voyager mission during the 1980s, the DSN began using very long baseline interferometry (VLBI) navigation to supplement conventional Doppler and ranging navigation techniques. The technique used two widely separated DSN stations on different continents to receive signals simultaneously from a spacecraft and from an angular nearby natural radio source (quasar) whose celestial coordinates were very well known. This enabled precise measurement of the angular separation between the

⁴ Charles Force, review comments of chapter. Also *Keeping Track: A History of the GSFC Tracking and Data Acquisition Networks: 1957 to 1991* (Greenbelt, MD: Goddard Space Flight Center [no date, c. 1992]), p. 75.

spacecraft and quasar, especially important when missions required a close flyby of a planet to obtain a gravity assist to change the trajectory.

The Aeronautics, Balloons, and Sounding Rockets (AB&SR) program was another component of NASA's GN program. With facilities at Wallops Flight Facility (WFF), Virginia; Dryden Flight Research Facility (DFRF) and Moffett Field, California; Poker Flat in Alaska; White Sands Missile Range in New Mexico; , and the National Scientific Balloon Facility in Texas, AB&SR supported primarily suborbital vehicles, such as balloons and sounding rockets.

The elements of NASA's Communications and Data Systems program linked the data acquisition station and users. These elements included communications, mission control, data capture and processing, and frequency management. Communications facilities during this decade consisted of the NASA Communications Network (NASCOM), which interconnected the tracking and data acquisition facilities for all flight projects by means of leased voice, data, video, and wideband circuits, and the Program Support Communications Network (PSCN), which linked NASA Headquarters (HQ) and Centers, and their major contractors.⁵

Tracking and Data Acquisition and Space Operations Overview (1989–1998)

NASA provided tracking and data acquisition support primarily through programs within its HQ Office of Space Communications (OSC).⁶ Through 1995, the Space and Ground Network, Communications, and Data Systems programs provided tracking, telemetry, command, and data acquisition support to meet the requirements of all NASA flight projects. In 1995, a restructuring

⁵ Office of Space Communications, "Space and Ground Networks, Communications and Data Systems, Space Flight, Control and Data Communications, Fiscal Year 1994 Estimates," p. SF 4-24.

⁶ Before 1992, this organization was called the Office of Space Operations.

split the Agency's tracking, telemetry, command, and data acquisition functions between two new programs: Mission Communications Services and Space Communications Services. In both arrangements, the major programs remained the GN, the SN, and the Communications and Data Systems programs (later called the Telecommunications program).⁷

As in the previous decade, the GN consisted of STDN, the DSN, and elements of the AB&SR program. Together, they formed a worldwide network of NASA electronic ground stations connected by a communications system that used ground, undersea, and satellite circuits. STDN provided prelaunch, launch, and landing communications required by Earth-orbiting spacecraft and the Space Shuttle. The DSN provided communications for planetary and solar system exploration missions, as well as for Earth-orbiting missions on a limited basis that could not be accessed by TDRSS. The AB&SR program included aeronautical research flight testing, launch vehicle tracking and communication, and support for the AB&SR elements of NASA's suborbital research and technology demonstration programs. It also provided tracking and communications support for a limited number of scientific spacecraft and for Space Shuttle landings.

The SN consisted of TDRSS, the primary system for supporting Earth-orbiting missions, and the associated ground elements necessary to meet the communications requirements of low-Earth-orbiting spacecraft missions. The network's Ground Segment included the White Sands Ground Terminal (WSGT) and the Second TDRSS Ground Terminal (STGT). A major SN milestone

⁷ "General Statement," Space Flight, Control and Data Communications Fiscal Year 1989 Estimates, p. SF SUM 1.

was reached in 1989 when TDRSS became fully operational in geosynchronous orbit.⁸ A second milestone was reached in 1998 when the Guam ground tracking station became operational. The SN then provided 100 percent coverage for low-Earth-orbiting spacecraft, an improvement over the 85 percent coverage available with the WSGT alone.

The Communications and Data Systems (or Telecommunications) program supported the operation, maintenance, and improvement of the NASCOM network and the PSCN. NASCOM provided for transmission of data, video, and voice information among NASA installations and between NASA mission operations control centers and the NASA space and ground networks. It also provided linkages to mobile tracking stations. The PSCN provided administrative and data handling services to international space agencies, other domestic users, scientists, laboratories, aerospace contractors, and educational institutions. In 1995, these two network programs merged their administrative and budgetary elements into a single network program called the NASA Integrated Services Network (NISN). The NASA Science Internet and Numerical Aerodynamic Simulation Network, both located at Ames Research Center, also merged into NISN.⁹

In addition, the Tracking and Data Advanced Systems research and development program focused on obtaining new, higher-performance tracking and data handling capabilities to support planned future missions.¹⁰

⁸ *Aeronautics and Space Report of the President, 1989–1990 Activities* (Washington, DC: National Aeronautics and Space Administration, 1991), p. 39.

⁹ Richard A. Helmick, former NISN project manager, e-mail to author, March 21, 2007.

¹⁰ “Advanced Systems,” Tracking and Data Advanced Systems Fiscal Year 1989 Estimates, p. RD 17-2.

The decade of 1989–1998 was a period during which NASA was challenged to become more efficient and reduce costs, especially in the face of decreasing budgets. In the operations area, it attempted to achieve this through consolidation of facilities, control capabilities, and contracts.

In the early 1990s, Congress expressed concern about the lack of standardization, commonality, and interoperability associated with national security satellite control networks and the high costs associated with operating, maintaining, and upgrading these networks. Beginning in 1992, three studies were completed over a two-year period that focused on increasing network efficiency and effectiveness and achieving economies by combining or sharing intra- and interagency satellite control capabilities.

In November 1992, NASA Administrator Daniel Goldin initiated development of a comprehensive and integrated long-term plan for future aerospace facilities so that they could meet government and commercial needs for aeronautics and space research and development and space operations.¹¹ This multi-agency effort involving NASA, DOD, the Department of Transportation (DOT), the Department of Energy (DOE), and the Department of Commerce (DOC), included cataloging the existing government and industry facilities that supported aeronautics and astronautics research, development, testing, and operations. The resulting National Facilities Study, released at the end of April 1994, included recommendations and rationales for new facilities, upgrades, consolidation, and closure of existing facilities, along with their cost impacts and other considerations. Although the bulk of the report dealt with aeronautical facilities, it also recommended reducing and consolidating facilities, people, and

¹¹ U.S. General Accounting Office, *Satellite Control Capabilities: National Policy Could Help Consolidation and Cost Savings*, GAO/NSIAD-96-77, May 1996, p. 11, <http://www.globalsecurity.org/space/library/report/gao/ns96077.pdf> (accessed March 30, 2007).

programs in “command and control, training, [and] tracking . . .” The report suggested establishing a multi-agency task force to study network optimization and operational consolidation. This task force would address “reduced interoperability between government-owned systems and less than optimal utilization of resources and facilities” resulting from the “historic development of independent satellite command and control systems.”¹²

A second study, under the auspices of the U.S. Space Command, dealt specifically with the defense space sector. Its report, issued in January 1994, called for the merger of Air Force and Navy satellite bus operations into a common satellite network.¹³

In January 1994, the Joint Chiefs of Staff initiated a third study—the Future Integrated Telemetry, Tracking and Commanding (TT&C) Architecture Study (FITAS)—which replaced the plans for action recommended in the National Facilities Study. FITAS involved participants from DOD, NASA, the National Reconnaissance Office, and NOAA of DOC. The FITAS draft report, issued in September 1994, suggested a two-stage approach to consolidating and providing opportunities for streamlining operations and realizing significant cost savings by the involved organizations through the upgrade and shared use of facilities and capabilities. NASA, in its comments on the draft report, suggested considering an integrated multi-agency architecture.¹⁴ The final study report, released in April 1995, concluded that sharing satellite control resources

¹² National Facilities Study Team, *National Facilities Study, Summary Report*, April 29, 1994, pp. 14, 16, 24–25.

¹³ U.S. GAO, *Satellite Control Capabilities: National Policy Could Help Consolidation and Cost Savings*, GAO/NSIAD-96-77, May 1996, p. 10.

¹⁴ Charles Force, Memo to U.S. Space Command, Cdr. Heatley, on the FITAS Draft Report, September 30, 1994.

could lead to efficiencies and stated that there was a clear need for a common satellite control architecture.¹⁵

In 1995, the Aeronautics and Astronautics Coordinating Board (AACB) tasked NASA and DOD with pursuing cooperative ventures that targeted cost reductions.¹⁶ Joint DOD-NASA integrated product teams (IPTs) were formed in the areas of 1) technology and laboratories, 2) major facilities, 3) space launch, 4) center/base support and services, 5) satellite telemetry, 6) tracking and command, 7) personnel exchange, and 8) interagency agreements. The teams developed recommendations relating to a wide range of activities from specific technologies, such as micro-electromechanical devices and fly-by-light systems, to infrastructure improvements, such as combined support contracts at field centers and exchange of scientists and engineers. The issue of spectrum management was specifically raised for the first time. Spectrum management was deemed important because DOD used an S-band frequency range for satellite command in the 1700–1800 MHz range, while U.S. civilian agencies and the international satellite community used the 2025–2110 MHz range, rendering communication between the two systems incompatible.¹⁷

In May 1996, the AACB met to review the results of the IPT efforts. It issued a final report with 34 recommendations for improving the efficiency and effectiveness of operations and reducing costs. Among its recommendations were:

¹⁵ U.S. GAO, *Satellite Control Capabilities: National Policy Could Help Consolidation and Cost Savings*, GAO/NSIAD-96-77, May 1996, p. 11.

¹⁶ The AACB was a senior management review and advisory body chartered in 1960 to help coordinate aeronautics and space activities and to meet the requirements of the Space Act.

¹⁷ John Rush and David Struba, NASA Headquarters, meeting with author, April 6, 2007.

- Combining spacecraft technology demonstrations and sharing the results from NASA and DOD experiments having similar objectives.
- sharing a C-17 aircraft hangar and cryogenics systems facility at Edwards Air Force Base/ NASA Dryden Flight Research Center.
- joint use at Langley Air Force Base/NASA Langley Research Center of an alternative fueling facility.
- Army Redstone Arsenal use of the photo laboratory at NASA Marshall Space Flight Center;
- NASA Kennedy Space Center use of Air Force medical supplies for its employee health facility at Patrick Air Force Base.¹⁸

Issues relating specifically to spectrum management and the lack of interoperability between DOD and NASA and other civilian and international agencies were not resolved. Rather, the committee passed on a recommendation to develop an “enduring management structure” to further study the issue.¹⁹

In 1998, the NASA Office of Inspector General (OIG) issued a report reviewing the AACB initiative. It concluded that the cooperative initiative had succeeded in improving government operations and saving more than an estimated \$1 billion for DOD and \$45 million for NASA.²⁰ However, the report concluded that actions to implement 18 of the 34 AACB recommendations

¹⁸ “DOD/NASA Coordinating Board Finds Ways To Avoid Costs,” *NASA News Release 96-91*, May 8, 1996, <http://www.nasa.gov/home/hqnews/1996/96-91.txt> (accessed March 20, 2007). Also e-mail from David Harris to author, December 13, 2006.

¹⁹ John Rush and David Struba, NASA Headquarters, meeting with author, April 6, 2007.

²⁰ DOD did not concur in this estimate. NASA Office of Inspector General, *Review Report: Review of The Aeronautics and Astronautics Coordinating Board (AACB) DOD/NASA Cooperation Initiative P&A-98-003*, September 28, 1998, p. 1, fn 1, http://oig.nasa.gov/old/partnerships_alliances/pa9803.pdf (accessed March 23, 2007).

were incomplete because of “insufficient management oversight and commitment.”²¹ In particular, it stated that DOD and NOAA did not appoint people to manage the implementation. The report identified remaining opportunities to achieve significant operating improvements and savings, including 1) using excess DOD rocket motors to launch small scientific spacecraft, 2) conducting joint spacecraft flight demonstrations to reduce development and launch costs, and 3) developing standardized spacecraft and ground control systems to permit interoperability, resulting in improved support, increased support reliability, and reduced tracking costs.²²

Further discussions continued between the NASA Administrator and senior DOD officials during the 1996–1998 time frame, but by the end of 1998 the spectrum issue had not been resolved and DOD continued to use a different spectrum range for satellite command incompatible with that used by other satellite users. The key result of discussions during this period was that they formed the foundation for future interoperability by studying a single band spectrum approach.²³ Not until 2003 did DOD begin to phase in a “dual band” approach to satellite control whereby its equipment would use both the original DOD S-band spectrum range of 1700–1800 MHz and the civilian S-band range of 2025–2110 MHz.²⁴

NASA also consolidated its operations contract structure during this decade. In 1996 and 1997, NASA began the process of consolidating and streamlining its major support contract services to reduce systems overlap and duplication in space operations, and reduce costs. Transition to a

²¹ NASA Office of Inspector General, *Review Report: Review of The Aeronautics and Astronautics Coordinating Board (AACB) DOD/NASA Cooperation Initiative P&A-98-003*, September 28, 1998, p. 1.

²² NASA OIG, *Review Report: Review of The Aeronautics and Astronautics Coordinating Board (AACB) DOD/NASA Cooperation Initiative P&A-98-003*, p. 2.

²³ John Rush and David Struba, NASA Headquarters, meeting with author, April 6, 2007.

²⁴ John P. Stenbit, Memorandum for Secretaries of the Military Departments; Director, National Reconnaissance Office; Director, Defense Advanced Research Projects Agency; Director, Missile Defense Agency; Subject: Space Systems Command and Control Spectrum Policy, August 4, 2003.

Consolidated Space Operations Contract (CSOC) began in 1998. The acquisition process was implemented in two phases. Two eight-month fixed-price study contracts were awarded to Boeing North American and Lockheed Martin on May 16, 1997 to develop an Integrated Operations Architecture approach to consolidate space operations activities across the Agency. On September 25, 1998, CSOC was competitively awarded to the Lockheed Martin Space Operations Company. This 10-year, cost-plus-award-fee contract began on January 1, 1999, when five individual space operations contracts transitioned to CSOC. Ten additional existing space operations contracts were scheduled to transition to CSOC during the contract's initial five-year period.²⁵

According to the contract's statement of work, the contractor's mission was to manage, be responsible for, and provide space operations services to meet the requirements of NASA's spaceflight and science programs. The contractor was to provide services that included acquiring data from a user vehicle or source, transmitting data to the end user, processing and storing data, and operating mission control centers. Services also included trajectory data processing, navigation analysis, and attitude determination. The services were to be available to all NASA space operations elements, including

- Planetary spacecraft of the JPL.
- Earth-orbiting robotic spacecraft operated by Goddard Space Flight Center.
- Suborbital programs conducted by the Wallops Flight Facility.
- Robotic spacecraft operated by NASA-sponsored science institutes.
- Human-tended spacecraft payload operations support at Marshall Space Flight Center.

²⁵ "Mission Communications Services," Fiscal Year 1999 Estimates, p. SAT 5-3. Also "Space Communications Services," Fiscal Year 2000 Estimates, p. MS 2-3; Rothenberg, statement, March 11, 1999, http://www.house.gov/science/Rothenberg_031199.htm (accessed September 20, 2006).

- Shuttle and space station programs at Johnson Space Center.
- spacecraft launch processing at Kennedy Space Center.

As a mechanism to further amortize investment and thereby reduce the overall cost to NASA, the contractor would also provide services to noncontract customers on an as-available basis and with government approval.²⁶

Management of NASA's Tracking and Data Acquisition and Space Operations Programs

Until mid-1996, NASA's tracking and data acquisition and space operations activities were managed by an independent HQ-level program office known as the Office of Space Operations (OSO) until 1992 and the Office of Space Communications (OSC) from 1992 to 1996. In 1996, NASA abolished the independent program office and folded OSC into the Office of Space Flight (OSF), which managed NASA's human spaceflight activities. At the Center level, JPL managed and operated the DSN. Goddard managed and operated NASA's Space Network and Ground Network. Marshall Space Flight Center managed NISN.

Headquarters Level

At the start of the decade, OSO at NASA HQ (designated Code T within NASA) managed the Agency's Ground Network, Space Network, and communications and data systems. From 1987 through the first half of 1989, Robert Aller served as OSO Associate Administrator. In July 1989, OSO Deputy Associate Administrator Charles Force replaced Aller as the new Associate Administrator. Jerry Fitts became the new Deputy Associate Administrator in September 1989,

²⁶ "Consolidated Space Operations Contract, Statement of Work," http://www.jsc.nasa.gov/news/contracts/NAS998100/rfp/sow_and_drds.doc (accessed September 20, 2006).

succeeding Force (see figure 4-1). Albert Miller was Assistant Associate Administrator for Plans.

OSO divisions and their directors were:

- Administration and Resources Management Division—Ronald Dapice
- Ground Network Division—Robert Hornstein
- Communications and Data Systems Division—Charles Fuechsel
- Space Network Division—Eugene Ferrick

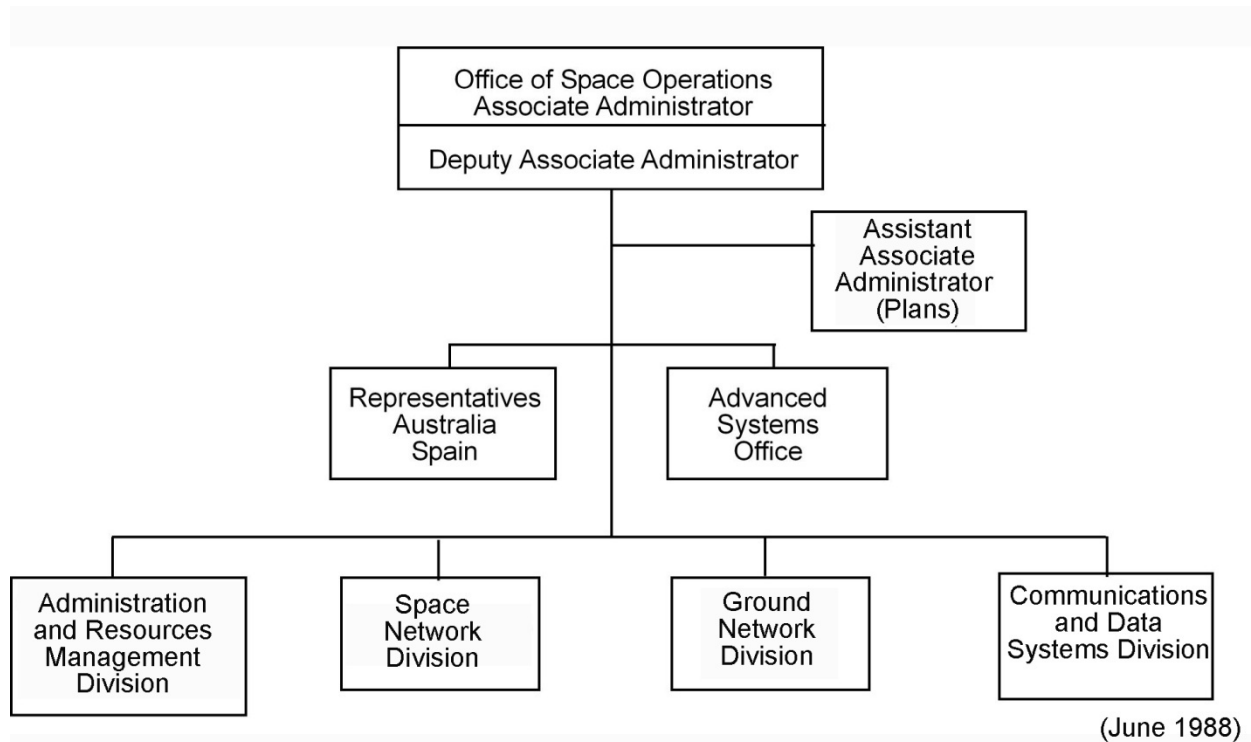

Figure 4-1. Office of Space Operations (Derived from NASA HQ Telephone Directory).

Early in 1990, OSO was redesignated Code O. Its functions remained the same.

In 1992, the name of the program office was changed to the Office of Space Communications (OSC). In 1993, a new division, the Program Integration Division, was added. David Harris was installed as its director.

In January 1994, Elmer Brooks replaced Fitts as OSC Deputy Associate Administrator. When he left that position in 1995, he was not replaced, and the position was eliminated in the reorganization that took place in 1996. In 1995, Fuechsel also left his position as Director of the Communications and Data Systems Division. Force took over as acting Division Director. The same year, Wilson Lundy replaced Ferrick as Director of the Space Network Division. In early 1996, Hornstein left the Ground Network Division and was replaced by Lundy on an acting basis. Lundy also served as acting Director of the Communications and Data Systems Division.²⁷

In 1995, NASA underwent a “zero-base review” “to identify strategies for sustaining its core programs in the face of significantly reduced future budget allowances, and to continue “implementing the principles underlying the NASA reinvention process.”²⁸ Basically, each organization was instructed to justify its programs and activities in an effort to achieve cost savings. A major NASA-wide restructuring resulted that consolidated organizations and reduced their size. A Space Operations Management Plan, prepared by an Agency team, called for NASA to emphasize research and development while outsourcing many operational elements in an effort to provide higher quality service at a lower cost.²⁹

In 1996, NASA established the Space Operations Management Office (SOMO), centered at Johnson Space Center (JSC), to oversee the Agency’s space operations activities and to

²⁷ The Spring 1996 Headquarters Directory shows Lundy in these three positions. Charles Force is listed as Associate Administrator.

²⁸ “Addressing the \$4 Billion FY 1997–2000 Budget Challenge: NASA’s Zero Base Review (ZBR),” <http://www.hq.nasa.gov/office/pao/97budget/zbr.txt> (accessed October 11, 2006).

²⁹ “Lyndon B. Johnson Space Center Annual Report, Fiscal Year 1997,” <http://www.jsc.nasa.gov/info/annualreports/1997/aerospace.html> (accessed September 20, 2006).

implement a planned Consolidated Space Operations Contract (CSOC). This Agency-wide organization was responsible for providing operations services such as communications, data transport, and space vehicle command and control. SOMO focused on reducing the cost of NASA's space operations and was to respond to data and mission operations requirements identified by specific NASA programs and projects, as well as to external customer requests for similar services on a non-interference basis. Its key responsibility was to ensure the efficient use of Agency assets and avoid duplication. The organization was kept small, and management of operations facilities and physical assets was retained by the centers. The Data Services Manager was a JPL employee, the Mission Services Manager was from Goddard Space Flight Center, and the Commercialization/NISN Manager was a Marshall Space Flight Center employee.³⁰

This period was a time of extensive reorganization within NASA. In April 1996, Force retired from the Agency, leaving his position as OSC Associate Administrator. He was replaced temporarily by Lundy and then by David Harris, both on an acting basis. In October 1996, OSC was eliminated as an independent program office and was incorporated within the Office of Space Flight (OSF) (designated Code M within NASA) headed by William Trafton (see figure 4-2). Other divisions within Code M were Space Station, Space Shuttle, and Business Management.³¹ The HQ's role was reduced to external interface, developing program requirements, and strategic planning.³²

³⁰ Joseph H. Rothenberg, statement before the Subcommittee on Space and Aeronautics Committee on Science, House of Representatives, March 11, 1999, http://www.house.gov/science/Rothenberg_031199.htm (accessed September 20, 2006).

³¹ See chapters 2 and 3 of volume VII of *NASA Historical Data Book, 1989–1998*, for additional details relating to the structure of Code M.

³² Rothenberg, statement, March 11, 1999, http://www.house.gov/science/Rothenberg_031199.htm (accessed September 20, 2006).

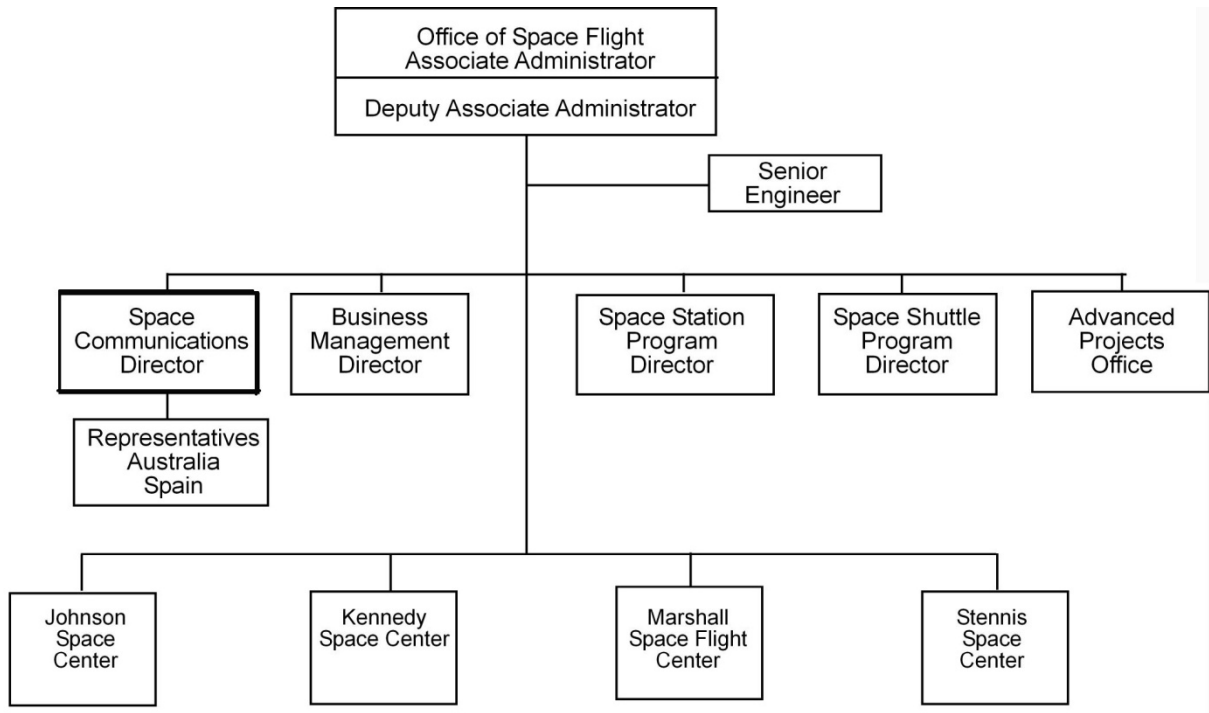

(August 1996)

Figure 4-2. In 1996, the Office of Space Communications was incorporated into the Office of Space Flight (Derived from NASA HQ Telephone Directory).

Within Code M, Harris was appointed the Deputy Associate Administrator for Space Communications. The divisions within the Space Communications organization continued to be Ground Network, Program Integration, Communications and Data Systems, Space Network. At the same time, Harris headed the Ground Network, Communications and Data Systems, and Space Network Divisions on an acting basis, and David Struba was acting head of the Program Integration Division. In addition, a Space Communications Office, within the Resources Management Division, was headed by Office Chief Joseph LaCurto. This office handled money issues for space communications. When Harris retired in September 1997, no one was appointed to fill his position as head of Space Communications, and the position was soon abolished.

In January 1998, Goddard Director Joseph Rothenberg left the center and moved to NASA HQ, replacing Trafton as Associate Administrator for OSF. Rothenberg named Robert Spearing to head the Space Communications Division, which was placed under the Deputy Associate Administrator for Space Shuttle, led by Steve Oswald.³³

NASA Center Level

Deep Space Network—Jet Propulsion Laboratory

JPL had responsibility for three Deep-Space Communications complexes in Canberra, Australia; Madrid, Spain; and Goldstone, California. It also managed and operated the Network Operations Control Center at Pasadena, California; the Space Flight Operations Facility at JPL; and the DSN's Ground Communications Facility (see figure 4-3). During the first part of the decade, the Tracking and Data Acquisition (TDA) program office at JPL, headed by an Assistant Laboratory Director for Tracking and Data Acquisition (ALD/TDA), managed DSN activities.³⁴

³³ *Spring/Summer 1998 Headquarters Directory*, NASA History Division electronic file, Historical Reference Collection, NASA Headquarters, Washington, DC.

³⁴ The basic structure of the JPL during this period consisted of offices headed by ALDs under the JPL director. Douglas J. Mudgway, *Uplink-Downlink: A History of the Deep Space Network 1957–1997* (Washington, DC: NASA 4227, 2001), pp. 590, 606.



Figure 4-3. This undated photo shows the Space Flight Operations Facility at the Jet Propulsion Laboratory. The facility was dedicated in May 1964. In 1985, the facility was designated a National Historic Landmark. It is still in use (NASA photo GPN-2003-00064).

In 1994, to support the NASA Space Communications and Operations program defined in JPL's Strategic Plan, and in an effort to be more efficient and cost-effective, JPL eliminated the TDA office and restructured and consolidated its functions. It merged the TDA and the Mission Operations Systems Office (MOSO) to create a new directorate, the Telecommunications and Mission Operations Directorate (TMOD), which drew on then-popular "reengineering" concepts and reflected a new and cost-effective approach to complex business management systems. The former TDA organization was consolidated into two offices: an office for planning, committing, and allocating DSN resources called the Plans and Commitments Office, and a second office for DSN operations and systems engineering called the DSN Data Services Office. DSN science and technology was handled in the Plans and Commitments Office, and development was incorporated in the Data Services Office. TMOD also included the Multimission Ground

Systems office, project offices of the four current inflight missions, and a new business office.³⁵

DSN operations, which did not change the way it delivered data to the customer, became referred to as the Data Capture Process.³⁶ The new organization's structure is shown in figure 4-4.

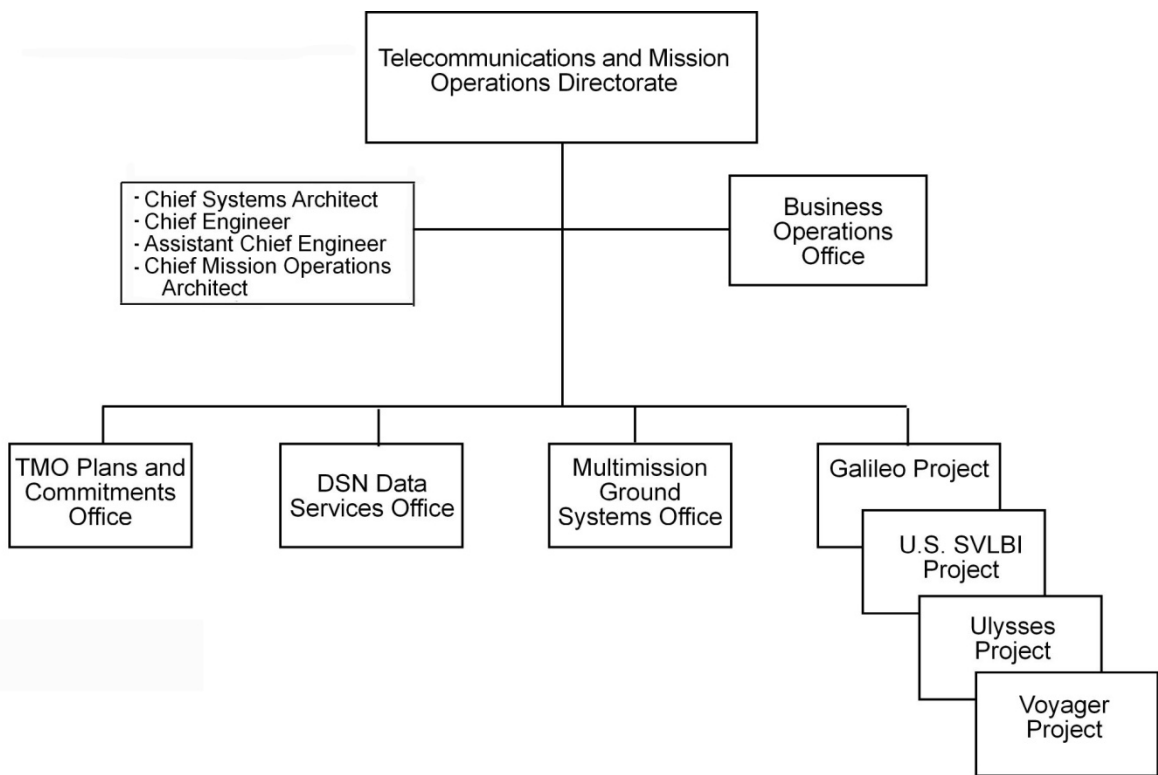

Figure 4-4. Telecommunications and Mission Operations Directorate, 1996 (Adapted from Mudgway, Uplink-Downlink, p. 613).

The heads of the DSN at JPL were Larry Dumas (ALD/TDA 1989–1992), Norman Haynes (ALD/TDA 1992–1996), Paul Westmoreland (TMOD Director 1996–1997), and Gael Squibb (TMOD Director 1997–2002).

³⁵ Mudgway, *Uplink-Downlink*, pp. 612–613.

³⁶ Mudgway, *Uplink-Downlink*, p. 614.

DSN facilities outside of the United States were operated by the host countries. In Australia, an intergovernment agreement covered issues such as ownership, taxation, import/export, and immigration. Detailed interagency agreements, reviewed annually, specified funding levels and forecasted work commitments.³⁷ On behalf of the Australian government, the Commonwealth Scientific and Industrial Research Organisation (CSIRO) Division of Telecommunications and Industrial Physics managed NASA activities in Australia. The staff and infrastructure providing engineering and operations support for the Canberra Deep Space Communication Complex (CDSCC) were supplied by Australian industry under a contract with CSIRO acting on behalf of the Australian government, and the complex director was employed by CSIRO. The director was responsible for routine management of the complex, its staff, and its facilities. NASA bore all costs for operating the complex.³⁸

Similar agreements existed between NASA and Spain for the management, engineering, and operations support for the Madrid Deep Space Communication Complex (MDSCC). In Spain, however, both the director and staff were employed by the Spanish government agency, Instituto Nacional Tecnica Aeroespacial (INTA), until 1992 when INTA, retaining the NASA contract, delegated maintenance and operation to its wholly-owned company, Ingenieria y Servicios Aeroespaciales (INSA).³⁹

³⁷ Jim O'Brien and Ian Tuohy, "Operation and Maintenance Support of the Canberra Deep Space Communications Complex," International Astronautical Federation, 1998, 1, NASA History Division folder 008846, Historical Reference Collection, NASA Headquarters, Washington, DC.

³⁸ Mudgway, *Uplink-Downlink*, p. 605. Also *Canberra Deep Space Communication Complex*, June 1997, 2, NASA History Division folder 8846, Historical Reference Collection, NASA Headquarters, Washington, DC.

³⁹ Mudgway, *Uplink-Downlink*, pp. 605–606.

Ground Network and Space Network—Goddard Space Flight Center

For most of the decade, the Mission Operations and Data Systems Directorate (MO&DSD) at Goddard Space Flight Center managed and operated the GN, the SN, TDRSS, NASA worldwide communications, and other functions needed to communicate, capture, process, and distribute data, and to compute orbit and attitude in support of space exploration and related activities. The heads of MO&DSD during this decade were Dale Fahnestock (1989–1995) and Arthur Fuchs (1995–1997). Specific divisions changed occasionally, but, in general, a Mission Operations Division developed, operated, and maintained mission planning systems and designed, developed, operated, and maintained the Goddard Payload Operations Control Centers, which were responsible for commanding a spacecraft and monitoring its health and safety status. The Flight Dynamics Division performed orbital computations, spacecraft attitude determination, and flight maneuvering, as well as commanding the spacecraft. The Networks Division provided tracking services and relayed commands to and data from user spacecraft through the Network Control Center (NCC). The NASA Communications (NASCOM) network provided data transport services. The Data Systems Technology Division advanced the quality and effectiveness of the data system by applying state-of-the-art technologies to system enhancements. The Information Processing Division was responsible for capturing and processing raw data so that end users would have usable information products.⁴⁰ This division was eliminated in 1995 when most of its functions were moved to the Mission Operations Division, then renamed the Mission Operations and Systems Development Division.

In 1997, Goddard underwent a “reengineering” and restructuring that aimed to improve efficiency and lessen redundancy in its programs. To bring MO&DSD functions closer to the

⁴⁰ *Goddard Organizational Manual*, January 1991 and January 1993.

overall work of the center, a separate MO&DSD was eliminated. Some MO&DSD offices were realigned and others moved into existing or newly formed directorates. Divisions that moved to the new Applied Engineering and Technology Directorate (AETD), headed by Brian Keegan, were replaced by “centers,” which were generally larger and encompassed more functions than the old divisions. Both the Data Systems Technology Division and the Mission Operations and Systems Development Division moved to the AETD Information Systems Center, with the functions of the former Information Processing Division handled by the Science Data Systems Branch. This center was headed by Marti Szczur. The Flight Dynamics Division moved to the Guidance, Navigation, and Control Center, headed by Frank Bauer. The Networks Division remained intact and was folded into the Flight Projects Directorate, creating an office called the Networks and Mission Services Project. This organization, headed by Philip Liebrecht, was responsible for NASA’s Space Network, Ground Network, and mission and data systems. The NASCOM network moved to the Management Operations Directorate.⁴¹

Money for Tracking and Data Acquisition and Space Operations

For the first part of the decade from 1989 to 1998, NASA’s tracking and data acquisition and space operations activities were funded almost entirely from the Space Flight Control and Data Communications (SFC&DC) appropriation. These funds provided tracking, telemetry, command, data acquisition, communications, and data processing support to meet the requirements of all

⁴¹ Goddard Space Flight Center Telephone Directories, October 1996 and March 1998. Also personal communication with Arthur Fuchs, former MO&DSD chief, September 2006.

NASA flight projects.⁴² A small amount for advanced systems activities was funded by the Research and Development (R&D) appropriation.

With the FY 1995 budget submission, NASA's appropriations were reconfigured, and funding for data acquisition and space operations was split between the Mission Support (MS) and Science, Aeronautics, and Technology (SAT) appropriations. The MS appropriation provided funds to operate, sustain, and replenish the SN, which supported operation of TDRSS; the ground terminals at White Sands, New Mexico; and the Network Control Center (NCC) at Goddard. Funds for services provided to non-science users of TDRSS were included under this program. This appropriation also funded the NASCOM network and the PSCN. The SAT appropriation provided funds for communications support for elements most directly related to NASA's science and aeronautics programs, including the GN, mission planning for robotics spacecraft programs, suborbital missions, and aeronautics test programs. Funds were provided to operate and sustain NASA's DSN, STDN, Wallops Flight Facility and subsidiary facilities, and the Western Aeronautical Test Range, which supported NASA's Robotic Science, Aeronautics, and Suborbital program.⁴³

The budget for NASA's tracking and data acquisition and space operations activities decreased significantly from 1989 to 1998, especially from FY 1993. At the end of the decade, funding programmed for these activities was \$141 million less than at the start of the decade. From FY 1993 on, Congress regularly reduced the amounts allocated for data acquisition and operations, causing the elimination of many support activities at NASA HQ and the cancellation of the

⁴² "General Statement," Fiscal Year 1991 Budget Estimates, p. AS 5.

⁴³ "General Statement," Fiscal Year 1995 Budget Estimates, pp. AS-9-AS-10.

Advanced Tracking and Data Relay Satellite System program. Programs were consolidated, and purchases and improvements were deferred. In an effort to increase efficiency and reduce costs, in FY 1998, NASA awarded a consolidated space operations contract to Lockheed Martin to outsource NASA's space operations under a single contract. The contract would manage all of NASA's data collection, telemetry, and communications operations supporting NASA's Earth-orbiting satellites, planetary exploration, and human spaceflight activities.⁴⁴

Funding to develop TDRSS was handled differently from most NASA projects. Rather than receiving development funds directly from Congress, which the Agency would then pay to a contractor for its services, NASA borrowed funds from the Federal Financing Bank (FFB), a government corporation supervised by the Secretary of the Treasury. These funds went directly to the owner-operator of TDRSS, the Space Communications Company, for program development. NASA repaid the loan to the FFB in FY 1991 and accrued interest and fees in FY 1992.

Table 4-1 shows programmed amounts for the years 1989–1998. Tables 4-2 through 4-34 show budget requests and programmed amounts for tracking and data acquisition and space operations activities. Since NASA typically submits an original and a revised budget request before Congress acts on a budget, both amounts are indicated, separated by a “/.” Where no amount appears, there was no submission. Programmed amounts reflect the amounts actually available to be spent. Occasionally, a budget category is established during a fiscal year. When this happens, there will be a programmed amount but no budget request for that budget category. Funds for these activities often were transferred from another project's budget through a “reprogramming”

⁴⁴ *Aeronautics and Space Report of the President, Fiscal Year 1998 Activities* (Washington, DC: National Aeronautics and Space Administration, no date), p. 4.

of funds during the year. All amounts come from the annual budget requests prepared by the NASA Office of the Chief Financial Officer (CFO). Explanations of changes in the budget figures also come from the annual CFO's budget submissions. An explanation of NASA's budget process can be found in chapter 1 of volume VII of this data book.

Tracking and Data Acquisition/Space Operations

NASA's tracking and data acquisition/space operations included its GN and SN facilities and services, data processing, and mission operations. Table 4-35 lists NASA's GN and SN tracking sites in use between 1989 and 1998.

Ground Network

NASA's Ground Network (GN) supported Earth orbital spaceflight; planetary and solar system exploration; and aeronautics, balloons, and sounding rockets (AB&SR) missions. The STDN, a network of geographically disbursed ground stations, supported Earth orbital missions. The DSN ground stations, located at three complexes approximately 120 degrees apart in longitude, supported planetary and solar system exploration missions as well as Earth orbital missions that were not compatible with TDRSS on a limited basis when STDN did not provide support. AB&SR research was supported by specially instrumented tracking ranges as well as by mobile systems.⁴⁵

⁴⁵ "Ground Networks," Space and Ground Networks, Communications and Data Systems, Fiscal Year 1989 Estimates, p. 3-11.

Ground Network Stations/STDN

The STDN, NASA's GN, was operated, maintained, and managed by Goddard Space Flight Center. It consisted of a number of tracking stations located around the world. Many of the STDN stations were located in polar locations to provide service to polar-orbiting spacecraft. The nonpolar ground stations supported low-inclination orbital missions, provided contingency support to geosynchronous spacecraft, and were located near launch ranges to provide effective launch range tracking support.⁴⁶ In addition to using the NASA-wide network, some space missions, such as Landsat and Far Ultraviolet Spectroscopic Explorer (FUSE), also used ground stations that were dedicated solely to receiving data from that mission.⁴⁷

The STDN's primary requirements were to be available during the Space Shuttle launch countdown sequence so that launch could proceed as planned, and to provide at least 99 percent of Space Shuttle data during the launch phase.⁴⁸ Stations at Merritt Island (MILA) and Ponce de Leon (PDL), Florida, and Bermuda were used primarily for Space Shuttle prelaunch, launch, range safety, and landing support. Also available on a standby basis for Space Shuttle missions and mission coverage beyond close-to-Earth phases were the DSN stations at Goldstone, Madrid, and Canberra.⁴⁹ Dryden Flight Research Center provided Shuttle landing support, and Bermuda and Wallops Flight Facility provided range safety support. GN stations also supported spaceflight missions of the DOD and NOAA on a reimbursable basis.

⁴⁶ *Ground Network (GN) Users' Guide, Revision 1*, p. 2-1, <http://scp.gsfc.nasa.gov/gn/gnusersguide3.pdf>.

⁴⁷ "Chapter 4—Ground System," *Landsat 7 Science Data Users Handbook*, http://landsathandbook.gsfc.nasa.gov/handbook/handbook_htmls/chapter4/chapter4.html (accessed 3 October 2006).

⁴⁸ "Mission Communications Services," Fiscal Year 1998 Estimates, p. SAT 5-7.

⁴⁹ *Keeping Track; GSFC Tracking and Data Acquisition Networks: 1957 to 1991* (Greenbelt, MD: Goddard Space Flight Center, no date, c. 1992), pp. 57, 76.

As the TDRSS became operational, the number of STDN stations fell from 20 in 1973 to 10 at the beginning of 1989 (plus facilities at Dryden).⁵⁰ On 30 September 1989, ground station operations ceased at Guam; Santiago, Chile; Kauai, Hawaii; and Yarragadee, Australia. Ascension Island ceased operations in November 1989.⁵¹ Facilities in Hawaii were transferred to other NASA elements, the state of Hawaii, and the U.S. Air Force.⁵² The station at Santiago was transferred to the University of Chile, and NASA purchased tracking services. The station at Dakar, Senegal, which provided support to the Shuttle during the launch phase of a mission, originally had been scheduled to cease operating at the same time; however, in late 1988, a decision was made to keep Dakar open until the second TDRS became operational. Ground stations at Merritt Island and Ponce de Leon, Florida, and Bermuda remained open to provide launch and landing support for the Shuttle.

In late 1993, NASA began phasing out the Dakar station. S-band voice communication ended in December 1993, and the facility was vacated in spring of 1994. UHF voice communication continued to be provided from a Senegalese government communication facility until December 1995, when all support from Senegal ended. Termination was feasible at that time because the second TDRSS ground terminal at White Sands, New Mexico, had been completed.⁵³

In FY 1994, STDN began providing only launch and landing support for Shuttle deployments. It continued to provide launch support for ELVs.

⁵⁰ "Locations and Capabilities of Goddard Tracking Stations," *NASA News Fact Sheet No. 89-14*, 1 February 1989, NASA History Division folder 6534, Historical Reference Collection, NASA Headquarters, Washington, DC. Also "Space and Ground Communications Networks To Provide Support for STS-29 Mission," *NASA News Release 89-06*, 1 February 1989, NASA History Division folder 6534, Historical Reference Collection, NASA Headquarters, Washington, DC.

⁵¹ "Space and Ground Networks, Communications, and Data Systems," Fiscal Year 1991 Estimates, p. SF 3-13.

⁵² Jim Costrell, e-mail to author, 27 March 2007.

⁵³ "Mission Communication Services," Fiscal Year 1995 Estimates, p. SAT 7-6.

In 1995, a new 10-meter (32.8-foot) antenna was installed at the National Science Foundation (NSF)'s McMurdo facility in Antarctica to acquire synthetic aperture radar (SAR) data from the NASA/Canadian Space Agency RadarSat spacecraft. The following year, new 11-meter (36-foot) antenna systems were added at the University of Alaska in Fairbanks and at the Wallops Orbital Tracking Station for use with the Japanese-United States Advanced Earth Orbiting Satellite (ADEOS) and other missions.

Between 1996 and 1998, the Norwegian Space Center (NSC) established a ground station on Norway's Svalbard islands within the Arctic Circle. The most northerly ground station in the world (located at 78°13'N), Svalbard Satellite Station (SvalSat) was unique because it covered all 14 daily passes of polar-orbiting satellites, allowing for a more continuous download of information. NASA triggered the station's development when the Agency asked for a location for an antenna to be used for its Earth Observing System (EOS) Polar Ground Network. The station's tracking, telemetry, and control activities were initiated in 1997 when Tromsø Satellite Station began operating the ground station under a contract with the NSC. NASA was its first customer, using it for its EOS satellites. NASA's Wallops Flight Facility initially installed one 11-meter (36-foot) S-X band antenna system at the site.⁵⁴

Advanced Range Instrumentation Aircraft (ARIA)

From 1968 to August 2001, ARIA (developed by NASA and the DOD, and originally named the Apollo Range Instrumentation Aircraft) tracked lunar missions as well as orbital and ballistic

⁵⁴ "Svalbard Ground Station, Norway," Aerospace Technology, <http://www.aerospace-technology.com/projects/svalbard/>. Also T. Andreassen et al., "Polar Bears and Spacecraft Tracking," *ESA Bulletin* 109 (February 2002): pp. 118–121 (both accessed 2 October 2006).

reentry programs. The program succumbed in 2001 to the costs associated with maintaining the aircraft and the network's capabilities.⁵⁵

ARIA consisted of EC-135E and EC-18B aircraft used as flexible airborne telemetry data recording and relay stations. These aircraft were designed and developed to supplement land and marine telemetry stations in support of DOD and NASA space and missile programs. ARIA could acquire, track, record, and retransmit telemetry signals, primarily in the S-band frequency range from 2,200 to 2,400 megahertz and the C-band frequency range from 4,150 to 4,250 megahertz. With additional modifications, ARIA could receive and record L-band and P-band frequencies.

ARIA deployed throughout the world to obtain telemetry data from orbital and reentry vehicles as well as air-to-air and cruise missile tests. Normally, the telemetry data were obtained in locations such as broad ocean areas and remote land areas outside the coverage of ground stations. Selected portions of data could be retransmitted in real time, via UHF satellite, to enable the launching agency to monitor system performance. All data were recorded on magnetic tape for postmission analysis.

Each ARIA was modified externally and internally from a standard C-135 or C-18 aircraft. Externally, the most obvious difference in appearance was the large, bulbous, "droop snoot" nose, a 10-foot (3-meter) radome housing a 7-foot (2-meter) steerable parabolic tracking antenna. The function of this subsystem, which was controlled by the antenna control assembly and the

⁵⁵ Leigh Anne Bierstine, "ARIA Makes Final Touchdown at Edwards," Air Force News Archives, 27 August 2001, <http://www.flyaria.com/document/html/sources/airforcelink/finaltouchdown.htm> (accessed 27 September 2006).

antenna operator, was to acquire and track telemetry signals. The ARIA also had a probe antenna on each wing tip and a trailing wire antenna on the bottom of the fuselage used for high-frequency radio transmission and reception. Further external modifications included antennas for data retransmission via UHF satellite. The internal modifications to the cargo compartment included all of the instrumentation subsystems installed in a 30,000-pound (13,608-kilogram) modular package.⁵⁶

Deep Space Network (DSN)

The DSN was maintained and operated by NASA. It comprised three clusters of antennas, each consisting of one large quasi-parabolic dish (70 meters [230 feet] in diameter) and several smaller antennas (34 meters [11 feet], 26 meters [85 feet], and 11 meters [36 feet] in diameter). They were spaced approximately 120 degrees apart in longitude. This configuration ensured that an antenna would always be within sight of a deep-space mission as Earth rotated. The Goldstone complex was located on the U.S. Army's Fort Irwin Military Reservation, approximately 72 kilometers (45 miles) northeast of Barstow, California, in the Mohave Desert. The Canberra complex was 40 kilometers (25 miles) southwest of Canberra near the Tidbinbilla Nature Reserve.⁵⁷ The Madrid complex was 60 kilometers (37 miles) west of Madrid at Robledo de Chavela. Each complex was situated in semi-mountainous, bowl-shaped terrain to shield against radiofrequency interference. All the stations were remotely operated from a centralized signal-processing center at each complex. The centers housed the electronic subsystems that pointed and controlled the antennas, received and processed the telemetry data, transmitted

⁵⁶ "EC-18 ARIA," FAS Military Analysis Network, <http://www.fas.org/man/dod-101/sys/ac/ec-18.htm> (accessed 27 September 2006).

⁵⁷ "Tidbinbilla" is an Aboriginal name for a "place where boys become men." Jim O'Brien and Ian Tuohy, "Operation and Maintenance Support of the Canberra Deep Space Communications Complex," International Astronautical Federation, 1998, p. 5, NASA History Division folder 008846, Historical Reference Collection, NASA Headquarters, Washington, DC.

⁵⁷ O'Brien and Tuohy, p. 4, NASA History Division folder 008846, Historical Reference Collection, NASA Headquarters, Washington, DC.

commands, and generated the spacecraft navigation data. After the data were processed at the complexes, they were transmitted to the JPL for further processing and distribution to science teams over a ground communications network.⁵⁸ Groups of antennas of the same size were referred to as “subnets” (e.g., the 34-meter [111-foot] subnet). Each antenna had a number designation preceded by “DSS.” Antennas at Goldstone were in the 10s and 20s range. Canberra used the 30s and 40s, and Madrid used the 50s and 60s to designate antennas at its complexes.

The network supported all planetary and interplanetary spacecraft, and provided emergency and backup support to the Space Shuttle, the TDRSS, and several Earth-orbiting spacecraft, including the Hubble Space Telescope.⁵⁹ DSN support of Earth-orbiting missions began with the International Cometary Explorer in 1984 and later included the Solar and Heliospheric Observatory (SOHO), Polar, Wind, Geotail, TOMS-EP, and Roëntgen missions.⁶⁰

Communicating throughout the solar system and into interstellar space, the DSN supported spacecraft launched more than 25 years ago using a combination of heritage analogue communications systems involving 1960s technology and modern state-of-the-art digital signal processing systems. Whereas conventional space communications systems operated over the distance to geostationary orbit, the DSN regularly communicated with spacecraft at a distance of more than 10.5 billion kilometers (6.5 billion miles) from Earth.⁶¹

⁵⁸ “Antennas,” Deep Space Network, <http://deepspace.jpl.nasa.gov/dsn/antennas/index.html> (accessed 20 September 2006).

⁵⁹ Mudgway, *Uplink-Downlink*, pp. 335–336.

⁶⁰ *Ibid.*, pp. 169, 333–335, 408, 434.

⁶¹ O’Brien and Tuohy, p. 3, NASA History Division folder 008846, Historical Reference Collection, NASA Headquarters, Washington, DC.

A centralized network control center, which was needed for advanced data handling, was located at the JPL. This control center provided seamless communications to the relevant mission control centers by scheduling the three complexes in sequence to enable a continuous link with the spacecraft.⁶² Other DSN facilities included a spacecraft compatibility test area at the JPL and a launch operations and compatibility facility at the STDN Merritt Island tracking station. The DSN facilities were also used for ground-based measurements in support of experiments in solar system radar and in the field of radio astronomy.⁶³

The DSN received science and engineering data from the spacecraft and transmitted navigation, command, and control signals to the spacecraft.⁶⁴ The bandwidths typically used were S-band at approximately 2,000 megahertz, X-band at approximately 8,000 megahertz, Ku-band at approximately 15,000 megahertz, and Ka-band at approximately 32,000 megahertz.⁶⁵

The major objectives of the DSN were to

- provide communications links to scientific spacecraft at greater distances and to increase the capability to receive images at these distances;
- increase the frequency range and data rate capability of the ground network to accommodate new deep-space missions;
- provide mission support for Earth-orbiting spacecraft that were not TDRSS-compatible and for which STDN required additional services (STDN was the primary resource for low-Earth-orbiting mission support when the mission was not designed for TDRSS support);

⁶² Ibid., p. 4.

⁶³ "Space and Ground Networks, Communications and Data Systems," Fiscal Year 1990 Estimates, pp. SF 3-12–SF 3-13.

⁶⁴ Ibid.

⁶⁵ *Canberra Deep Space Communication Complex*, June 1997, p. 8.

- provide improved navigation capabilities for precise spacecraft targeting and probe delivery;
- provide emergency support to TDRSS-compatible spacecraft.⁶⁶

In 1993, NASA began a phased upgrade program to increase the DSN's capacity and add new capabilities required for current and future missions. The upgrade was needed to accommodate the increasing number and sophistication of spacecraft. Specific improvements included additional antenna subnets, which could be arrayed together to effectively improve performance and implementation of systems for orbiting very-long-baseline interferometry (OVLBI) astronomy missions, deep-space missions, and Earth-observation missions.⁶⁷

The **26-meter (85-foot)-diameter antennas** were originally built to support the Apollo missions to the Moon between 1967 and 1975. In later years they supported Earth-orbiting spacecraft, most of which orbited between 160 and 1,000 kilometers (100–630 miles) above Earth, as well as highly elliptical missions such as the SOHO spacecraft that were out of view of TDRSS. The X-Y mount on these antennas allowed them to point low on the horizon to pick up the fast-moving Earth orbiters as soon as they rose into view. The maximum tracking speed was 3 degrees per second.⁶⁸

The **70-meter (230-foot)-diameter antennas** were the largest and therefore the most sensitive DSN antennas. They could track a spacecraft traveling more than 16 billion kilometers (10 billion miles) from Earth. Massive in size, the hydraulically-driven dish reflectors and their

⁶⁶ "Space and Ground Networks, Communications and Data Systems," Fiscal Year 1991 Estimates, p. SF 3-14.

⁶⁷ "Space and Ground Networks, Communications and Data Systems," Space Flight, Control and Data Communications, Fiscal Year 1994 Estimates, p. SF 4-15.

⁶⁸ "26-meter Antennas," <http://deepspace.jpl.nasa.gov/dsn/antennas/26m.html> (accessed 20 September 2006).

azimuth-elevation mounts atop the concrete pedestals weighed nearly 2.7 million kilograms (2,970 tons).⁶⁹ Because of their size, these antennas rotated on an unusual azimuth bearing system, called a hydrostatic bearing, that allowed them to rotate smoothly. The rotating mass was supported on a 0.25-millimeter-thick film of oil. Large amounts of lead counter balanced the antennas' tipping structure.⁷⁰ Figure 4-5 shows the Canberra 70-meter antenna.



Figure 4-5. This photo shows the 70-meter (230-foot) antenna at Canberra (NASA photo GPN-2000-000502).

⁶⁹ “70-meter Antennas,” <http://deepspace.jpl.nasa.gov/dsn/antennas/70m.html> (accessed 20 September 2006).

⁷⁰ Also *Canberra Deep Space Communication Complex*, June 1997, 4, NASA History Division folder 8846, Historical Reference Collection, NASA Headquarters, Washington, DC.

The 70-meter antennas were originally built as 64-meter (210-foot)-diameter antennas. They were expanded to 70 meters between 1982 and 1988 to increase their sensitivity to support Voyager 2's encounter with Neptune. These antennas were used for Very-Long-Baseline Interferometry (VLBI) and supported both X- and S-band uplink and downlink. The 70-meter at Goldstone was also used for radar astronomy, or Goldstone Solar System Radar (GSSR).⁷¹ Figure 4-6 shows the structure housing the electronics of the 70-meter antenna at Goldstone.



Figure 4-6. This photo shows the structure housing the electronics on the 70-meter (230-foot) antenna at the Goldstone Complex. Note the size of the person on the ladder at the center of the vertical pointing antenna in comparison to the size of the dish (NASA photo JPL 9015).

⁷¹ "Chapter 18. Deep Space Network," *Basics of Space Flight, Section III*, <http://www2.jpl.nasa.gov/basics/bsf18-2.html> (accessed 18 September 2006).

On 28 June 1992, the Goldstone area was hit by two major earthquakes within a few hours of each other. The 70-meter antenna (DSS 14) was damaged, but parts were repaired or replaced and the antenna returned to full use within three weeks. An engineering team that was formed immediately after the earthquake assessed the damage, assisted with the antenna's return to service, and recommended action to ensure that all of the 70-meter antennas would have increased protection against future earthquakes. Over the next three years, equipment was installed on all 70-meter antennas to make them more earthquake-resistant.⁷²

Other maintenance has been required on the 70-meter antennas. In the spring of 1990, following the failure and repair of the elevation bearing on Madrid's 70-meter antenna (DSS 63) in December 1989, the DSN temporarily halted the use of all the 70-meter antennas in order to inspect the bearings and equalize the loads on inboard and outboard elevation bearings. In 1991, the original roller bearings were replaced with solid roller bearings.

The **34-meter (111-foot) high-efficiency (HEF) antennas** (DSS 15, 45, and 65) were installed at each complex in the 1980s to replace the older 34-meter standard (STD) subnet antennas that were to be decommissioned in the 1990s. The 34-meter STD antennas had a polar-axis design. They were originally built with 26-meter (85-foot)-diameter reflectors and later upgraded to 34 meters. The upgrade required the entire antenna to be repositioned on concrete footings so that the reflector could point to low elevations without striking the ground. The 34-meter STD antenna at Goldstone (DSS 12) was decommissioned in 1996 and converted to an educational

⁷² Mudgway, *Uplink-Downlink*, pp. 341–342.

resource named the Goldstone-Apple Valley Radio Telescope (GAVRT).⁷³ The 34-meter STD antennas at Madrid (DSS 61) and Canberra (DSS 42) were decommissioned in 1999.⁷⁴

The 34-meter HEF subnet was designed with the more efficient azimuth-elevation mounting and a 34-meter reflector, with a precision-shaped surface for maximum signal-gathering capability at X-band radiofrequencies. In addition to tracking spacecraft, the DSN 34-meter HEF subnet was used for VLBI and radio-source catalog maintenance.⁷⁵ These antennas supported X-band uplink and downlink, and S-band downlink.⁷⁶ DSS 15 (at Goldstone) and DSS 45 (at Canberra) became operational in 1984, and DSS 65 (at Madrid) became operational in 1987. All remain in use.

A small antenna located near DSS 45 at Canberra was connected to the Global Positioning System (GPS) receiver. This allowed simultaneous tracking of up to eight NAVSTAR GPS satellites, and its applications included ionospheric calibration, geodesy, satellite orbit determination, and clock synchronization. The receiver was fully automated and did not require an operator except for occasional calibration and maintenance. It was in use 24 hours per day, every day of the year.⁷⁷

The **34-meter (111-foot) beam waveguide** (BWG) subnet primarily supported deep-space missions but could occasionally support a mission in high Earth orbit. These antennas generally

⁷³ Ibid., p. 438.

⁷⁴ Ibid., p. 439.

⁷⁵ Interplanetary Network Directorate, *DSMS Telecommunications Link Design Handbook*, DSMS No. 810-005, Rev. E, 15 January 2001. JPL D-19379, Rev E, Jet Propulsion Laboratory, 2000, Module 104, Rev. B, "Module 103, "34-m HEF Subnet Telecommunications Interfaces," p. 5, <http://deepspace.jpl.nasa.gov/dsndocs/810-005/103/103.pdf> (accessed 26 September 2006).

⁷⁶ "Chapter 18. Deep Space Network," *Basics of Space Flight, Section III*, <http://www2.jpl.nasa.gov/basics/bsf18-2.html> (accessed 18 September 2006).

⁷⁷ *Canberra Deep Space Communication Complex*, June 1997, 20, NASA History Division folder 8846, Historical Reference Collection, NASA Headquarters, Washington, DC.

had X- and S-band uplink and downlink capabilities, although some at the Goldstone complex also had Ka-band capability.⁷⁸ The antenna subnet met expanded coverage requirements and could provide coverage of two deep-space missions simultaneously.⁷⁹ The BWG antenna was recognizable by the opening in the middle of the main reflector rather than a cluster of microwave equipment in the feed cone. It incorporated a dual-shape design as well as a BWG. A series of five precision radiofrequency reflectors reflected radio signals along a BWG tube from the vertex of the antenna to the stationary pedestal equipment room below the dish, ensuring that the signal would be focused onto the receiver as the antenna moved around in azimuth and in elevation.⁸⁰ The transmission and reception equipment for the BWG antenna was located underground, which reduced the dish's weight and allowed for maintenance of equipment while the antenna was tracking.⁸¹

The design of the first 34-meter multifrequency BWG antenna was initiated in 1989 at Goldstone, and construction of the first antenna was completed in 1991. The antenna (DSS 13) replaced a 26-meter (85-foot) antenna that had been at the Venus site since 1962. DSS 13 was the first antenna of its kind used for deep-space communications.⁸²

⁷⁸ "Space and Ground Networks, Communications and Data Systems," Fiscal Year 1994 Estimates, p. SF 4-15. Also "Mission Communication Services," Fiscal Year 1995 Estimates, p. SAT 7-18; "Mission Communications Services," Fiscal Year 1997 Estimates, p. SAT 5-8; and "Chapter 18. Deep Space Network," *Basics of Space Flight, Section III*, <http://www2.jpl.nasa.gov/basics/bsf18-2.html> (accessed 18 September 2006).

⁷⁹ "Mission Communication Services," Fiscal Year 1999 Estimates, p. SAT 5-5.

⁸⁰ J. W. Layland and L. L. Rauch, "The Evolution of Technology in the Deep Space Network: A History of the Advanced Systems Program," *TDA Progress Report* 42-130 (15 August 1997): p. 3, http://deepspace.jpl.nasa.gov/technology/95_20/95-20.pdf (accessed 25 September 2006). Also "34-Meter Antennas," <http://deepspace.jpl.nasa.gov/dsn/antennas/34m.html> (accessed 20 September 2006).

⁸¹ "Canberra Deep Space Communication Complex," http://www.cdsc.nasa.gov/Pages2/pg01h_history.html (accessed 19 September 2006). Also "Tidbinbilla," Canberra Deep Space Communication Complex, http://www.cdsc.nasa.gov/Pages2/pg01g_history.html (accessed 18 September 2006).

⁸² "New Beam-Waveguide Antenna at the Venus Research and Development Site, Goldstone, California," <http://deepspace.jpl.nasa.gov/dsn/history/dsn75.html> (accessed 15 September 2006).

Construction of two new BWG antennas began at Goldstone in FY 1993. These new antennas became operational in 1995. Two additional BWG antennas at Goldstone became operational in 1996. Funding in FY 1994 provided for an additional 34-meter BWG antenna at the Canberra complex that became operational in FY 1997. The Madrid BWG antenna became operational in FY 1998. Figure 4-7 shows three 34-meter BWG antennas at the Goldstone complex.



Figure 4-7. This photo shows three 34-meter (111-foot)-diameter beam waveguide antennas at the Goldstone Deep Space Communications Complex (NASA photo GPN-2000-000506).

The newer high-speed BWG (HSB) antennas (DSS 27 and DSS 28) differed from the older BWG antennas in that the pedestal room was above ground level, the microwave optics design was different, and the subreflector did not focus automatically for the purpose of maintaining

gain as the antenna's elevation angle changed. The HSB antenna had higher tracking rates than the older BWG antenna and was equipped primarily for tracking Earth-orbiting satellites.⁸³

In 1996, NASA obtained two experimental 34-meter antennas for use at Goldstone as a result of an agreement with the U.S. Army. These antennas differed in design from the DSN antennas and would require extensive modifications before they could be used for deep-space tracking. In the meantime, the first antenna became operational in late 1996 and was used to track highly elliptical Earth orbiters.⁸⁴

An **11-meter (36-foot) capability** for the OVLBI mission became available at Greenbank, West Virginia, in 1996 as a result of a joint NASA-NSF project that restored an obsolete 14-meter (46-foot) NSF antenna for the program.⁸⁵ In 1996, the VLBI technique was expanded into space with the installation of 11-meter antennas at each DSN complex to provide data acquisition capability for the Institute of Space and Astronautical Science (ISAS) Japanese VLBI Space Operations Program (VSOP) spacecraft, launched in February 1997.⁸⁶

Arraying Antennas

Arraying antennas was a technique used to increase the effective aperture, strengthen the reception of a spacecraft's weak signals, and permit spacecraft to downlink data at a higher rate.

⁸³ Interplanetary Network Directorate, *DSMS Telecommunications Link Design Handbook*, DSMS No. 810-005, Rev. E, 15 January 2001. JPL D-19379, Rev E, Jet Propulsion Laboratory, 2000, Module 104, Rev. B, "34-m BWG Stations Telecommunications Interfaces," p. 6, <http://deepspace.jpl.nasa.gov/dsndocs/810-005/104/104B.pdf> (accessed 28 September 2006).

⁸⁴ "Mission Communication Services," Fiscal Year 1995 Estimates, p. SAT 7-18.

⁸⁵ "Mission Communications Services," Fiscal Year 1997 Estimates, p. SAT 6-5.

⁸⁶ "Tidbinbilla," Canberra Deep Space Communication Complex, http://www.cdsc.nasa.gov/Pages2/pg01g_history.html (accessed 18 September 2006). Also "Mission Communications Services," Fiscal Year 1999 Estimates, p. SAT 5-5.

It consisted of electronically combining the signals from two or more antennas at the same DSN complex, at two different complexes, or with a non-DSN radio telescope. The DSN used arraying for single missions in the early 1970s, and in 1977 began to develop arraying capability for the entire network. To create more receiving capability for Voyager's encounter with Neptune in 1989, the Australian government provided the Parkes Radio Telescope used in combination with the DSN site at Canberra. Signals were combined from the 27 antennas of the NSF's Very Large Array in New Mexico into a single signal and then further combined with those at the Goldstone DSN site. The Japanese Deep Space Station at Usuda was also used during the closest approach to Neptune to provide radio science data as Voyager passed behind Neptune and its moon, Triton.⁸⁷ The Galileo mission to Jupiter used arraying from June 1996 to November 1997 to increase the science data return during its primary mission. This was especially important given the failure of the high-gain antenna on the spacecraft. For this mission, the DSN arrayed up to five antennas from tracking facilities at Goldstone, Canberra, and Parkes in Australia. The result was a threefold improvement in data return compared to that achieved with a single 70-meter (230-foot) antenna.⁸⁸

Aeronautics, Balloons and Sounding Rockets (AB&SR)

The AB&SR program encompassed the ground support capabilities needed to capture scientific and engineering data from aircraft, balloons, sounding rockets, and some Earth-orbiting vehicles engaged in scientific research. The primary fixed facilities were located at Wallops Flight Facility (WFF, managed by Goddard), the Moffett Field Flight Complex (MFFC), and the

⁸⁷ *Aeronautics and Space Report of the President, 1989–1990 Activities*, p. 40.

⁸⁸ "Antenna Arraying," <http://deepspace.jpl.nasa.gov/dsn/antennas/array.html> (accessed 26 September 2006). Also "Chapter 18. Deep Space Network," *Basics of Space Flight, Section III*, <http://www2.jpl.nasa.gov/basics/bsf18-2.html> (accessed 18 September 2006).

Dryden Flight Research Facility (DFRF), which was part of Ames Research Center until 1994, when it returned to independent NASA center status.

Ames Research Center managed the ranges at MFFC, Crows Landing, and DFRF.⁸⁹ These sites were configured to support aeronautics research. Dryden had the additional capability to support Shuttle tracking and telemetry landing operations.

The operations program included the operations and maintenance of ground-based fixed and mobile instrumentation systems. These facilities supported NASA aeronautics and suborbital programs, as well as a limited number of Earth-orbit research programs. The Western Aeronautics Test Range (WATR), which consisted of test ranges at Dryden and Moffett Field, provided communications, tracking, data acquisition, and mission control for aeronautics and aerospace vehicles, including the Shuttle and Mir operations during the Shuttle-Mir series of flights. WATR customers included other NASA centers; the U.S. Army, Air Force, and Navy; the Federal Aviation Administration; and the aerospace industry.⁹⁰ Activities at Wallops supported aeronautics programs as well as sounding-rocket, balloon, and Earth-orbiting satellite programs.⁹¹

In 1992, NASA installed an 8-meter (26-foot) precision tracking telemetry antenna at the Poker Flat Research Range, about 30 miles (48 kilometers) northeast of Fairbanks, Alaska, to support the NASA Plasma Physics Program. A new precision tracking mobile C-band NASA radar was

⁸⁹ Crows Landing was approximately 80 miles (129 kilometers) southeast of San Francisco.

⁹⁰ "Mission Communication Services," Fiscal Year 2000 Estimates, p. SAT 5-9.

⁹¹ "Space and Ground Networks, Communications and Data Systems," Fiscal Year 1990 Estimates, pp. SF 3-18–SF 3-20.

also placed in operation at the site.⁹² Two additional antennas (5 meters [16 feet] and 11.3 meters [37 feet]) were installed in 1995 to form the Poker Flat Tracking Station (PFTS). The station provided a beneficial tracking location for polar-orbiting satellites due to its high latitude.⁹³ The Poker Flat Research Range, which was owned by the University of Alaska and had been the site for sounding-rocket launches since the 1970s, was the only nonfederal university owned and operated range in the world, and the only high-latitude, auroral-zone rocket launching facility in the United States.⁹⁴ (See chapter 4 [“Space Science”] of volume VII of the *NASA Historical Data Book, 1989–1998*, for a description of NASA’s Sounding-Rocket and Balloon program.)

The Automated Wallops Orbital Tracking Station (AWOTS) consisted of three highly automated tracking systems: a 5-meter (16-foot) Low-Earth-Orbiter Terminal (LEO-T), an 8-meter (26-foot) Transportable Orbital Tracking System (TOTS), and an 11.3-meter (37-foot) X- and S-band tracking system. The station provided 24-hour space tracking operations for missions such as the Cosmic Background Explorer (COBE), International Ultraviolet Explorer (IUE), Interplanetary Monitoring Platform-8 (IMP-8), Nimbus-7, Meteosat and Landsat, NOAA polar-orbiting satellites, Total Ozone Mapper (TOMS)/Meteor-3, and Roëntgen Satellite (ROSAT).⁹⁵

Through a series of interagency and international agreements and collaborations, NASA’s GN program provided an increasing level of tracking, command, and data acquisition support for NASA and other U.S. and international flight agencies studying global change. In cooperation with other U.S. agencies, facilities at McMurdo Sound, Antarctica, and Fairbanks, Alaska, were

⁹² “Space and Ground Networks, Communications and Data Systems,” Fiscal Year 1994 Estimates, p. SF 4-20.

⁹³ “NASA/GSFC/WFF Ground Network Resources,” October 1997.

⁹⁴ “Poker Flat Research Range,” <http://www.pfrr.alaska.edu/pfrr/index.html> (accessed 4 October 2006).

⁹⁵ “Space and Ground Networks, Communications and Data Systems,” Fiscal Year 1993 Estimates, p. SF 4-18.

developed as the principal ground stations for the joint U.S.-Canada RadarSat mission and the international Advanced Earth Observing System (ADEOS) mission, respectively. The Fairbanks site served as the main U.S. ground communication facility for the international Earth Remote Sensing Satellite (ERS) and the Japanese Earth Resources Satellite (JERS) synthetic aperture radar (SAR) missions. The site consisted of two automated tracking systems: a 10-meter (33-foot) X- and S-band system, and an 11.3-meter (37-foot) X- and S-band tracking system.⁹⁶ The McMurdo facility consisted of an automated 10-meter tracking system that provided a beneficial tracking location for polar-orbiting satellites due to the station's high latitude. Its primary functions were to perform tracking and data acquisition for the SAR satellite systems and polar-orbiting S-band missions, and launch vehicle/payload tracking during launch and early orbit periods of high-inclination missions. The station also supported TDRSS.⁹⁷

In 1995, Wallops was the primary ground station for the IUE, Earth Radiation Budget Satellite (ERBS), Solar Anomalous and Magnetospheric Particle Explorer (SAMPEX), COBE, and Nimbus-7 missions, and the primary U.S. ground station for the international TOMS-Meteor, European Remote Sensing Satellite (ERS-1), JERS-1, ROSAT, and IMP-8 platform. Operational support for NOAA-9 and NOAA-10 was also provided.⁹⁸

WFF was upgraded in the mid-1990s. Systems design was completed in 1995, and installation of upgraded data-handling systems followed. A new 11-meter (36-foot) antenna was installed in

⁹⁶ "Mission Communication Services," Fiscal Year 1996 Estimates, p. SAT 6-6. Also "NASA/GSFC/WFF Ground Network Resources," October 1997.

⁹⁷ "NASA/GSFC/WFF Ground Network Resources," October 1997.

⁹⁸ "Mission Communication Services," Fiscal Year 1996 Estimates, p. SAT 6-11.

1997 and a second was mounted in 1998.⁹⁹ Wallops also installed and tested a Redstone Telemetry system at the White Sands Missile Range and the Poker Flat Research Range. Both units were to support sounding-rocket launches. In Svalbard, Norway, and Fairbanks, Alaska, WFF installed 11-meter (36-foot) systems to provide backup and housekeeping support to the EOS AM-1 spacecraft and the Landsat-7 spacecraft.

Toward the end of the decade, significant modernization work was completed at the WATR in California. This included refurbishing the Dryden radar systems, replacing the graphic display in the mission control center for faster and higher-resolution data presentation, and overhauling Dryden's telemetry antennas.¹⁰⁰ The ability to present research data in real time to researchers remote from Dryden was critical to the future success of the WATR and the research missions it supported. The capability to process and display GPS parameters was incorporated in the Mission Control Center (MCC) and used to support the F-18 Sequential Ranging Assembly (SRA). Other projects, such as the Unpiloted Aerial Vehicle (UAV) missions, also used the new capability. GPS flight units were demonstrated and implemented on NASA-sponsored missions. The demonstration aimed to minimize future tracking and navigation activities. The Student Nitric Oxide Explorer (SNOE) mission demonstrated the new capabilities using commercial flight units as the primary source of the function.¹⁰¹ The Global Real-time Interactive Map (GRIM) was upgraded to handle the added requirements of projects such as the X-38, Linear Aerospike (LASRE), X-36, and Environmental Research Aircraft Sensor Technology (ERAST). The Test Evaluation Command Control System was installed in the MCC to provide backup to GRIM. The Telemetry and Radar Acquisition Processing System (TRAPS) was upgraded to

⁹⁹ Ibid., p. SAT 6-12.

¹⁰⁰ "Mission Communication Services," Fiscal Year 1997 Estimates, p. SAT 6-8.

¹⁰¹ "Mission Communication Services," Fiscal Year 2000 Estimates, p. SAT 5-5.

support four real time Pulse Code Modulation (PCM) telemetry streams. In addition, the capability to process up to 32 streams of wideband frequency-modulated (FM) and constant-bandwidth data was incorporated into TRAPS and used successfully by the F-16 Supersonic Laminar Flow Control project. The relocation of the mobile systems from Ames Research Center to Dryden was accomplished, as was the relocation of aircraft from Ames to Dryden.¹⁰²

Space Network (SN)

NASA's SN consisted of the TDRSS and the associated ground elements needed to meet the communications requirements of low-Earth-orbital spacecraft missions.¹⁰³ The network provided uplink and downlink satellite and ground communication links connecting the NASA elements of the network and any remotely located user facilities.¹⁰⁴ It also provided inflight communication with spacecraft in low-Earth orbit and tracking, telemetry, data acquisition, and command services. NASA also occasionally leased particular bandwidths for use by commercial telecommunications entities.¹⁰⁵ The fully operational TDRSS consisted of three satellites, including an on-orbit spare in geostationary orbit and networked ground facilities located at White Sands, New Mexico, and (since 1998) on Guam (see figure 4-8).

¹⁰² "Mission Communication Services," Fiscal Year 1999 Estimates, pp. SAT 5-9-5-10.

¹⁰³ The satellites are referred to as the "space segment." The ground elements are called the "ground segment."

¹⁰⁴ "Space Network," Space and Ground Networks, Communications and Data Systems, Fiscal Year 1989 Estimates, p. 3-4. Also "Space Communication Services," Fiscal Year 1995 Estimates, p. MS 2-4.

¹⁰⁵ "TDRSS C-Band Agreement Extended," *NASA News Release* 91-181, 1 November 1991, <ftp://ftp.hq.nasa.gov/pub/pao/pressrel/1991/91-181.txt> (accessed 17 October 2006).

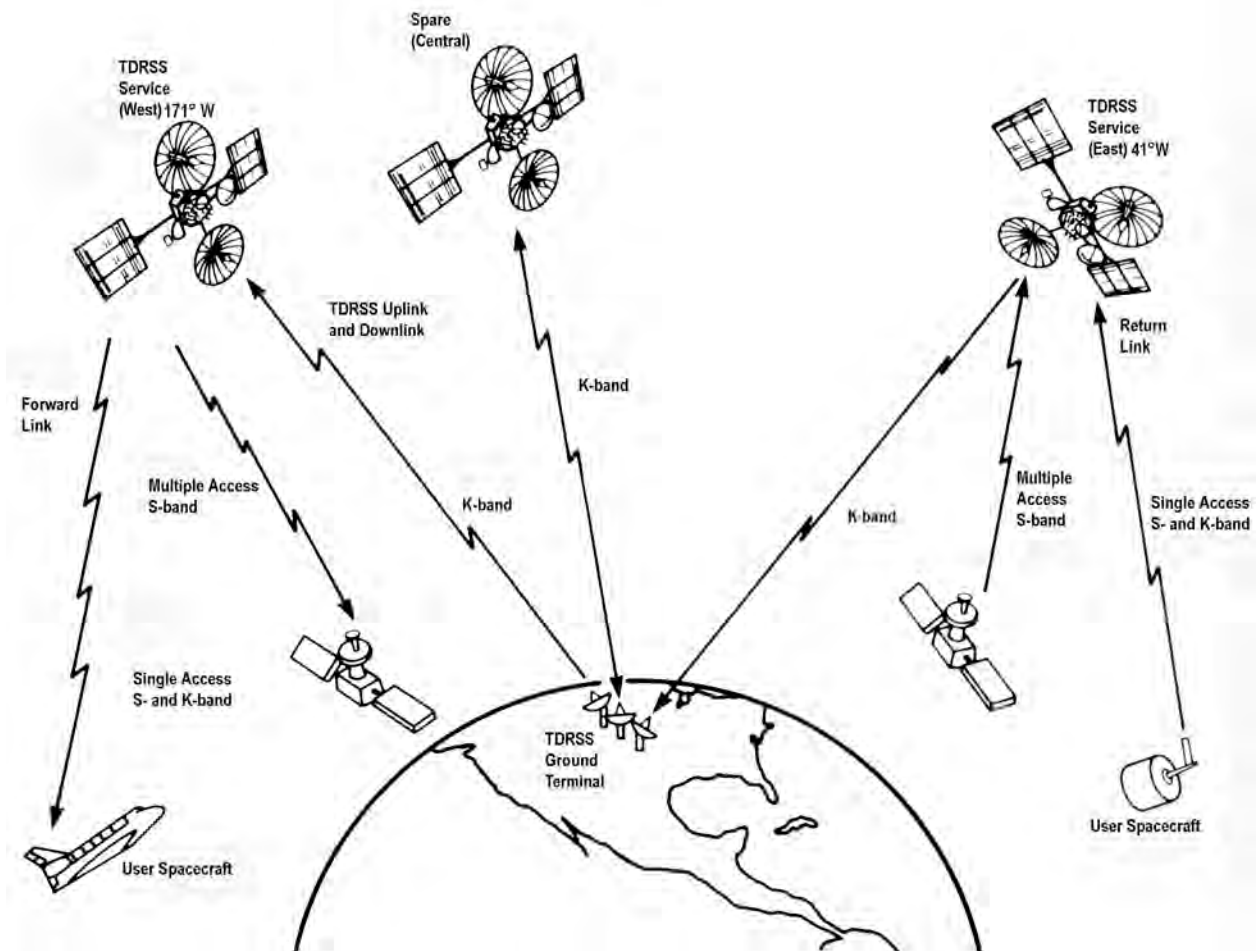

Figure 4-8. TDRSS constellation showing three interchangeable spacecraft (STS-29 press kit).

The TDRSS was initiated after studies in the early 1970s concluded that a system of telecommunications satellites, operated from a single ground station, could meet the needs of NASA's mission better and more cost-effectively than the existing network of tracking and communications ground stations located around the world. Analyses conducted by the General Accounting Office, NASA, and Congress indicated that a leased system would be most efficient. In December 1976, NASA awarded a contract to Western Union Space Communications, Inc. (Spacecom) for development and 10 years of operations of telecommunications services that would be leased to NASA. Western Union would build, own, and operate the system, which

would consist of a space segment (initially a single spacecraft) and ground terminal at White Sands, New Mexico. The contract included both a single spacecraft providing domestic communications services and a ground segment. NASA and Western Union planned to share the spacecraft, which would carry both Advanced Westar commercial communications equipment and TDRSS hardware.

In 1980, the contract was transferred to a partnership of Western Union, Fairchild, and Continental Telephone. However, NASA and Western Union soon decided that a single satellite would not meet the needs of both NASA and Western Union, and that separate satellites were preferable. In 1983, Western Union sold its share of the network to Continental Telephone and Fairchild. In 1985, Fairchild sold its share to Continental Telephone (Contel), leaving Contel as the single remaining partner. TRW and Harris were major subcontractors; TRW built the spacecraft, and TRW and Harris built the ground station. This unusual contractual arrangement left NASA without direct management of the spacecraft and ground station builders, creating many technical and contractual challenges to achieving operational status. Contel continued its ownership and operation of the system until 1 July 1990, when NASA took title of TDRSS—42 months earlier than called for in the existent contract, which specified a date of 29 December 1993. The remaining two TDRSs (TDRS-E and TDRS-F) were built under direct NASA contract with TRW. Contel continued to provide maintenance and operations support to the space segment (satellites), and its contract to operate and maintain the White Sands Ground Terminal (WSGT) was extended through 30 September 1995. Allied-Signal Technical Services Corporation (later Bendix Corporation) was selected to operate the Second TDRSS Ground

Terminal (STGT) and won the contract for operations at both ground terminals when the Contel contract concluded.¹⁰⁶

In addition to the S- and Ku-band capacity used by NASA, the TDRSS satellites also carried a C-band capacity antenna designed for commercial use. The bandwidth could provide commercial and government voice, data, and video services linking Asia, North America, and Europe. In late 1988, discussions began between NASA and Intelsat regarding the possibility of using this C-band capacity on the TDRSS network. NASA received bids from Intelsat and Columbia Communications Corporation for lease of the bandwidth. Columbia's \$61 million offer exceeded Intelsat's by more than \$10 million, and NASA selected Columbia to lease the C-band capacity. Although the relationship between NASA and Columbia was difficult and complicated by delays and legal wrangling before the bandwidth was used, the agreement progressed and Columbia made its first payment of more than \$10 million to NASA in 1991.¹⁰⁷ In November 1991, NASA and Columbia agreed to delay for up to six months the commencement of C-band operations. To compensate NASA for the extension, Columbia agreed to pay "anywhere from \$2.5 million to \$10 million in increased payments" later in the lease period depending on when operations actually began. A restructuring in July 1993 allowed Columbia to share with NASA all revenues received from leasing the C-band capacity to third parties.¹⁰⁸ On-orbit testing and transmissions

¹⁰⁶ *Keeping Track: A History of the GSFC Tracking and Data Acquisition Networks: 1957 to 1991* (Greenbelt, MD: NASA Goddard Space Flight Center, no date, c. 1992), p. 75. Also "Tracking and Data Relay Satellite System (TDRSS), <http://roland.grc.nasa.gov/~dglover/sat/tdrss.html>; "Tracking and Data Relay Satellite System," Mission and Spacecraft Library, <http://msl.jpl.nasa.gov/Programs/tdrss.html> (both accessed 17 October 2006); "Contel To Transfer Title of TDRSS to NASA," *NASA News Release 90-86*, 21 June 1990, NASA History Division folder 6534, Historical Reference Collection, NASA Headquarters, Washington, DC; Phil Liebrecht, "NASA Takes Title to the TDRSS," *Mission Operations and Data Systems Newsletter* 6, no. 4 (September 1990): pp. 3-4; Rumerman, *NASA Historical Data Book, Volume VI*, p. 314.

¹⁰⁷ David Harris, e-mail to author, 20 December 2006.

¹⁰⁸ "TDRSS C-band Agreement Extended," *NASA News Release 91-181*, 1 November 1991, <http://www.nasa.gov/home/hqnews/1991/91-181.txt>. Also "TDRSS C-Band Agreement Restructured," *NASA News*

using the C-band began in 1993, and the bandwidth was used to carry telephone service to war-torn Bosnia in August 1993.¹⁰⁹ In November 1994, the Federal Communications Commission granted Columbia special temporary authority to provide simultaneous domestic and international service using the TDRSS C-band capacity. In December, Columbia announced it would use TDRSS to provide this service across North America, Europe, and Asia.¹¹⁰ The next year, Columbia used TDRSS to transmit television shows (for example, it delivered David Letterman's show from CBS in New York to London). In November 1995, NASA and Columbia agreed to extend Columbia's commercial C-band operations on TDRSS through December 2001.¹¹¹

The first TDRS, TDRS-1 (A), was launched in 1983. TDRS-B was lost in the *Challenger* accident in 1986.¹¹² TDRS-3 (C) was launched in 1988 on the return-to-flight STS-26 mission. When on-orbit checkout of this satellite was completed in 1989, the satellite was redesignated TDRS-3, and the system was declared fully operational.¹¹³

Release 93-126, 13 July 1993, <http://www.nasa.gov/home/hqnews/1993/93-126.txt> (both accessed 19 December 2006).

¹⁰⁹ "Columbia Carries Telephone Service to Bosnia," Columbia Communications Corporation Press Releases, 16 August 1993, <http://www.davidchurchill.com/sections/sites/ccc/releases/pr-aug16-93.html>. Also "Columbia Communications To Carry Digital Global Service for Associated Press Television," Columbia Communications Corporation Press Releases, 17 December 1994, <http://www.davidchurchill.com/sections/sites/ccc/releases/pr-dec17-94.html> (accessed 19 December 2006); "TS News—New Columbia TDRSS Satellite Enters Service," <http://www.sat-net.com/listserver/ts-news/msg00039.html> (both accessed 26 March 2007).

¹¹⁰ "Columbia Communications Corporation Receives FCC Authority To Provide a Full Range of Domestic Services," Columbia Communications Corporation Press Releases, <http://www.davidchurchill.com/sections/sites/ccc/releases/pr-nov07-94.html>. Also "Columbia Communications To Carry Digital Global Service for Associated Press Television, Columbia Communications Corporation Press Releases, <http://www.davidchurchill.com/sections/sites/ccc/releases/pr-dec17-94.html> (both accessed 19 December 2006).

¹¹¹ "NAA Extends Columbia/TDRSS Agreement until 2001," Columbia Communications Corporation Press Releases, <http://www.davidchurchill.com/sections/sites/ccc/releases/pr-nov16-95.html> (accessed 19 December 2006).

¹¹² Typically, a satellite receives a number designation when it is declared operational. TDRS-B was lost in the *Challenger* accident and the number 2 was never used to designate this satellite, nor was it reassigned.

¹¹³ See volume VI of the *NASA Historical Data Book, 1979–1998*, for additional details of the earlier TDRSS.

TDRS-4 (D) was launched on 13 March 1989 and declared operational on 5 June 1989.¹¹⁴ It replaced TDRS-1 at 41°W over the Atlantic.¹¹⁵ TDRS-5 (E) was launched on 2 August 1991 and became operational in October 1991. It replaced TDRS-3 at 174°W in the TDRSS constellation. TDRS-3 was then moved to a central location and designated the on-orbit emergency backup spacecraft for the network.¹¹⁶ TDRS-6 (F) was launched 13 January 1993, and TDRS-7 (G) was launched on 13 July 1995. The last two satellites were initially stored on orbit. TDRS-7 was the final TDRS in the original series of satellites. It replaced TDRS-B, which had been lost in the 1986 *Challenger* accident.¹¹⁷ After the TDRS-7 launch and checkout, the system achieved the requirement of having two fully operational satellites and two fully operational “ready reserve” satellites.¹¹⁸ At the time of the TDRS-7 launch, TDRS-1 was used primarily to provide service to the Compton Gamma Ray Observatory (CGRO) spacecraft, which had a failed tape recorder.

All of the satellites were launched from the Space Shuttle and placed in geosynchronous orbit by means of an inertial upper stage. Figure 4-9 shows the deployment sequence for TDRS-F. Figure 4-10 shows the satellite as it is about to be released from the *Endeavour*'s cargo bay.

¹¹⁴ “Tracking and Data Relay Satellite-4 Declared Operational,” *NASA News Release 89-86*, 5 June 1989, NASA History Division folder 6545, Historical Reference Collection, NASA Headquarters, Washington, DC.

¹¹⁵ TDRS-1 was moved to the Pacific as a spare because of minor failures on TDRS-3. In 1993, TDRS-1 was moved to 85°E to provide service the Gamma Ray Observatory. Donald H. Martin, *Communication Satellites*, 4th ed. (El Segundo, CA: Aerospace Corporation, 2000), p. 298.

¹¹⁶ *Aeronautics and Space Report of the President, Fiscal Year 1991 Activities* (Washington, DC: National Aeronautics and Space Administration, 1992), p. 43. Also “New TDRS Operational over Pacific, Boosting System Capacity,” *Aerospace Daily* (10 October 1991): p. 66, NASA History Division folder 6534, Historical Reference Collection, NASA Headquarters, Washington, DC.

¹¹⁷ The designation TDRS-2 was never used.

¹¹⁸ Space Shuttle Mission STS-70 Press Kit,” May 1995, p. 20, http://www.jsc.nasa.gov/history/shuttle_pk/pk/Flight_070_STS-070_Press_Kit.pdf.

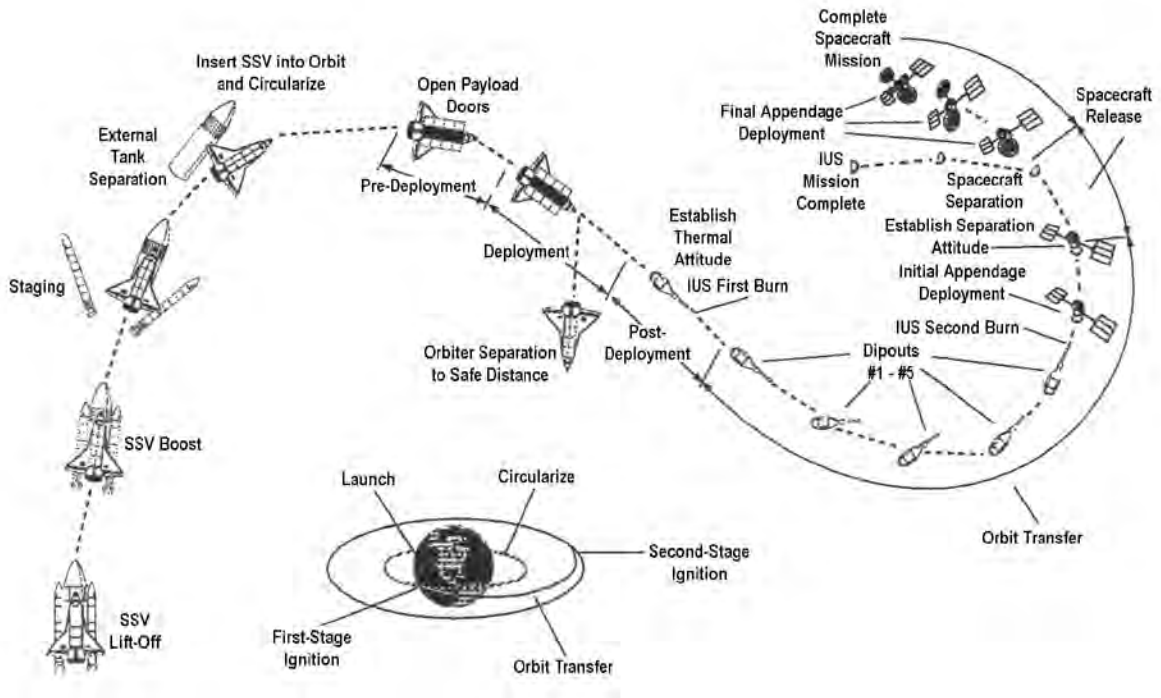

Figure 4-9. TDRS-F deployment sequence (STS-54 press kit).

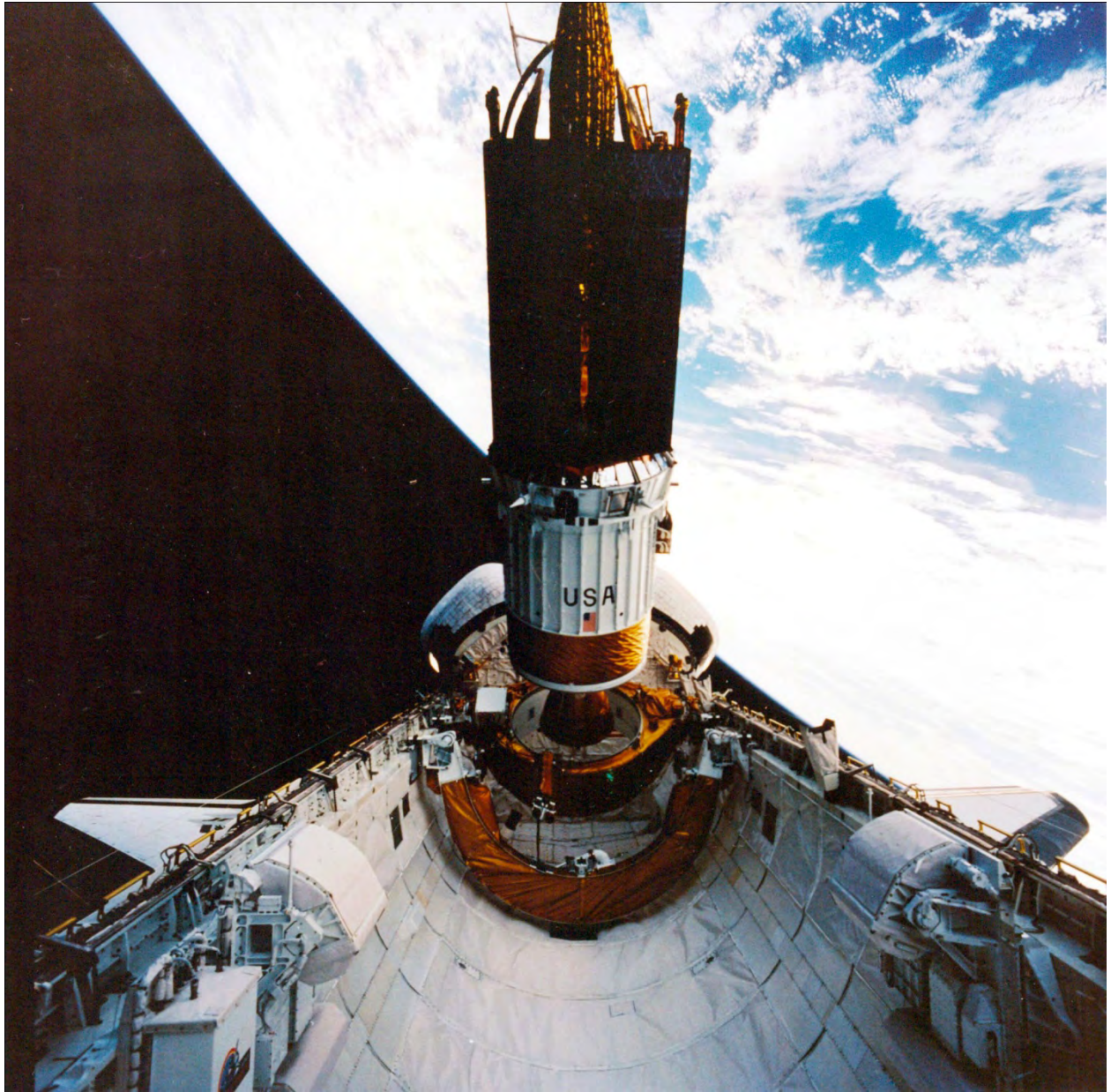

Figure 4-10. This photo shows TDRS-F as it is about to be released from its cradle/tilt table in Endeavour's cargo bay (NASA photo STS 054-71-025).

TDRSS enabled NASA to cut telecommunications costs and increase global coverage of Earth-orbiting spacecraft from 15 percent to 85 percent for most satellites, and data acquisition and communications contact time with spacecraft by a factor of 6. In April 1994, the opening of the GRO Remote Terminal System (GRTS) in Tidbinbilla, Australia, at the Canberra DSN to

support the CGRO further increased coverage of orbiting spacecraft to 100 percent. Until this ground station opened, the TDRSS could not “see” a spacecraft during approximately 15 percent of its orbit over an area of the Indian Ocean (called the zone of exclusion). GRTS closed in 1998, when it was replaced by the Guam Remote Ground Terminal (GRGT).

The satellite system served as a repeater, or “bent pipe,” transmitting voice, television, and analog and digital data signals between the user spacecraft and the ground terminal in both directions without processing or altering data. After the signals were received at White Sands, telemetry reached the Earth-based operator or researcher of a particular spacecraft through NASCOM (renamed the NASA Integrated Services Network [NISN] in 1997), based at Goddard Space Flight Center. NASCOM was a global system that used a variety of communication lines, including commercial satellites, to transmit data. Thus, transmissions sent by a low-Earth-orbiting spacecraft could take a path that included a TDRS to White Sands, perhaps back up to a commercial communications satellite, and then down again to Goddard. Then the signal could go from Goddard back to another commercial communications satellite, and from there to its final destination: the operator of the spacecraft (such as Mission Control at Johnson Space Center in the case of the Space Shuttle).¹¹⁹ At its highest capacity, the TDRSS could transfer in 1 second the equivalent of a 20-volume encyclopedia containing more than 34 million words.¹²⁰

The TDRSS offered communications service in three frequency bandwidths: S-band, high-capacity Ku-band, and C-band. NASA used the S- and Ku-bands. The C-band was used by the

¹¹⁹ “NASA’s Tracking and Data Relay Satellite: Tracking and Communications,” KSC Release No. 63-88, December 1992, <http://www-pao.ksc.nasa.gov/kscpao/nasafact/tdrstac.htm> (accessed 11 September 2006).

¹²⁰ *Aeronautics and Space Report of the President, Fiscal Year 1993 Activities* (Washington, DC: National Aeronautics and Space Administration, 1994), p. 35.

commercial sector to relay domestic and international ground television and data transmissions. The S- and Ku-bands each included forward data links from the ground through a satellite to users, return data links, and tracking links for gathering data used to compute the orbits of user satellites.¹²¹ Nominally, the system could support up to 24 user spacecraft (including the Space Shuttle) simultaneously. S-band multiple-access (MA) service could relay data from as many as 20 low-data-rate customer satellites simultaneously. One return link was used for calibration, leaving 19 links available to users. S- and Ku-band single-access (SA) antennas provided two high-data-rate channels from both the eastern and western locations.¹²² SA service included simultaneous forward and return links.

In the second half of the decade, the TDRSS began to assume responsibility for ELV launch support, which at the time was provided by the U.S. Air Force's ARIA, for major phases of the Titan IV and Atlas II missions. Previously, up to five ARIA were needed to support a launch. The TDRSS remote ground terminal in Australia also supported Shuttle-Mir crews during rendezvous and docking operations.¹²³

The TDRSS satellites were positioned in geosynchronous orbits above the equator at an altitude of 22,300 statute miles (35,888 kilometers). At this altitude, each satellite would remain fixed in orbit over one location because its speed was the same as the rotational speed of Earth. TDRS-

¹²¹ Martin, *Communication Satellites*, 4th ed., p. 295.

¹²² Space Shuttle Mission STS-70 Press Kit." May 1995, p. 18, http://www.jsc.nasa.gov/history/shuttle_pk/pk/Flight_070_STS-070_Press_Kit.pdf. Also "STS-43 Press Information," July 1991, Rockwell International Space Systems Division, p. 34, http://www.jsc.nasa.gov/history/shuttle_pk/mrk/FLIGHT_042-STS-043_MRK.pdf (both accessed 28 September 2006).

¹²³ *Aeronautics and Space Report of the President, Fiscal Year 1996 Activities* (Washington, DC: National Aeronautics and Space Administration, no date), p. 42.

East and TDRS-West were positioned 130 degrees apart. This positioning reduced the ground station requirements to one station.¹²⁴

Figure 4-11 shows the system with five orbiting satellites as it was configured in 1993—with two operational satellites, two backups, and TDRS-1 dedicated primarily to Gamma Ray Observatory tracking.

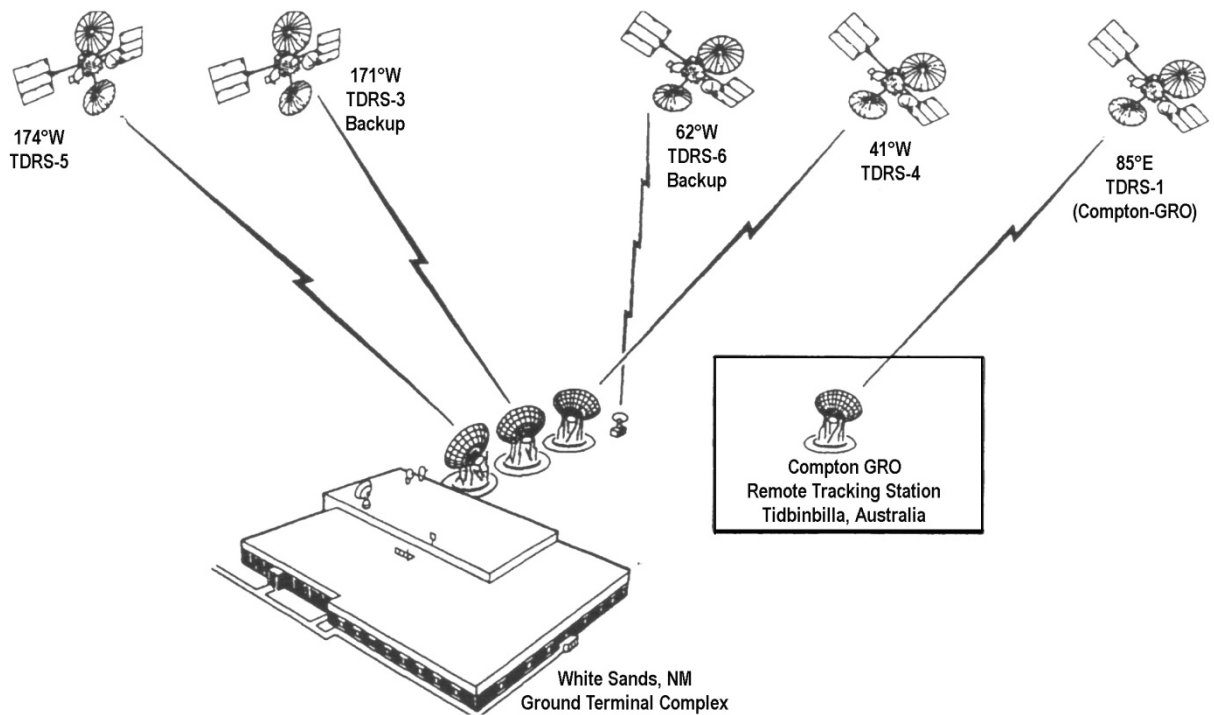

Figure 4-11. The TDRS system with five orbiting satellites (two operational satellites and three backups) after the launch of TDRS-6 (F) in 1993 (STS-54 press kit).

The four TDRSs launched during this decade were virtually identical. Each consisted of three distinct modules: an equipment module, a communications payload module, and an antenna

¹²⁴ The satellites were generally repositioned after on-orbit checkout. At the time of the TDRS-7 launch in 1995, six satellites were orbiting and being used in an active or backup capacity.

module. The modular design reduced the cost of individual design and construction efforts, which in turn lowered the cost of each satellite. Each satellite used three-axis stabilization, measured 57 feet (17.4 meters) across its solar panels, and weighed about 5,000 pounds (2,540 kilograms). They were among the largest, heaviest, and most complicated satellites ever launched into geosynchronous orbit. In their first 10 years of operations, through April 1993, the TDRSS relayed approximately 3.5 million minutes of data to the ground.¹²⁵

The equipment module, located in the lower hexagon portion of the main body of the spacecraft, housed the subsystems that operated the satellite. The attitude control subsystem stabilized the satellite to provide accurate antenna pointing and proper orientation of the solar panels to the Sun. The electrical power subsystem consisted of two solar panels that provided a 10-year power supply of approximately 1,700 watts. Nickel cadmium rechargeable batteries supplied full power when the satellite was in Earth's shadow. The thermal control subsystem consisted of surface coatings and controlled electric heaters.

The payload module, located on the upper hexagon portion of the main body of the spacecraft, contained the electronic equipment and associated antennas required for communications between the user spacecraft and the ground terminal. The receiver and transmitter services were mounted in compartments on the back of the SA antennas.¹²⁶

The antenna module consisted of five antenna systems, and each system had seven antennas (two SA antennas, an MA antenna array, the space-to-ground-link [STGL], and the S-band omni

¹²⁵ *Aeronautics and Space Report of the President, Fiscal Year 1993 Activities*, p. 35.

¹²⁶ "Space Shuttle Mission STS-43 Press Kit," July 1991, http://www.jsc.nasa.gov/history/shuttle_pk/pk/Flight_042_STS-043_Press_Kit.pdf (accessed 28 September 2006).

antenna for satellite health and housekeeping; see figure 4-12). For SA service, each TDRS had two dual-feed, S-band/Ku-band deployable parabolic antennas. These antennas were attached on two axes that could move horizontally or vertically, directing the radio beam to orbiting user spacecraft below. When deployed, they measured 16 feet (4.9 meters) in diameter and spanned 43 feet (13.1 meters) from tip to tip. They could be pointed up to 90 degrees off nadir away from the satellite or up to 30 degrees off nadir toward the satellite body, and rotated ± 90 degrees from nadir about the axis that included their deployment booms.¹²⁷ The SA antennas were used primarily to relay communications to and from user spacecraft. The high data rate provided by these antennas was available to users on a time-shared basis. Each antenna could support two user spacecraft services simultaneously (one at S-band and one at Ku-band), provided that both users were within the antenna's beam width. The antenna's primary reflector surface was a gold-clad molybdenum wire mesh woven like cloth. When deployed, each antenna's 203 square feet (18.9 square meters) of mesh was stretched tautly on 16 supporting tubular ribs by fine threadlike quartz cords. The entire antenna structure, including the ribs, reflector surface, a dual-frequency antenna feed, and the deployment mechanisms that folded and unfolded the structure, weighed approximately 50 pounds (22.7 kilograms).¹²⁸ Table 4-36 summarizes the TDRSS baseline service.

¹²⁷ Martin, p. 296.

¹²⁸ "STS-43 Press Information," July 1991, Rockwell International Space Systems Division, p. 34, http://www.jsc.nasa.gov/history/shuttle_pk/mrk/FLIGHT_042-STS-043_MRK.pdf (accessed 28 September 2006).

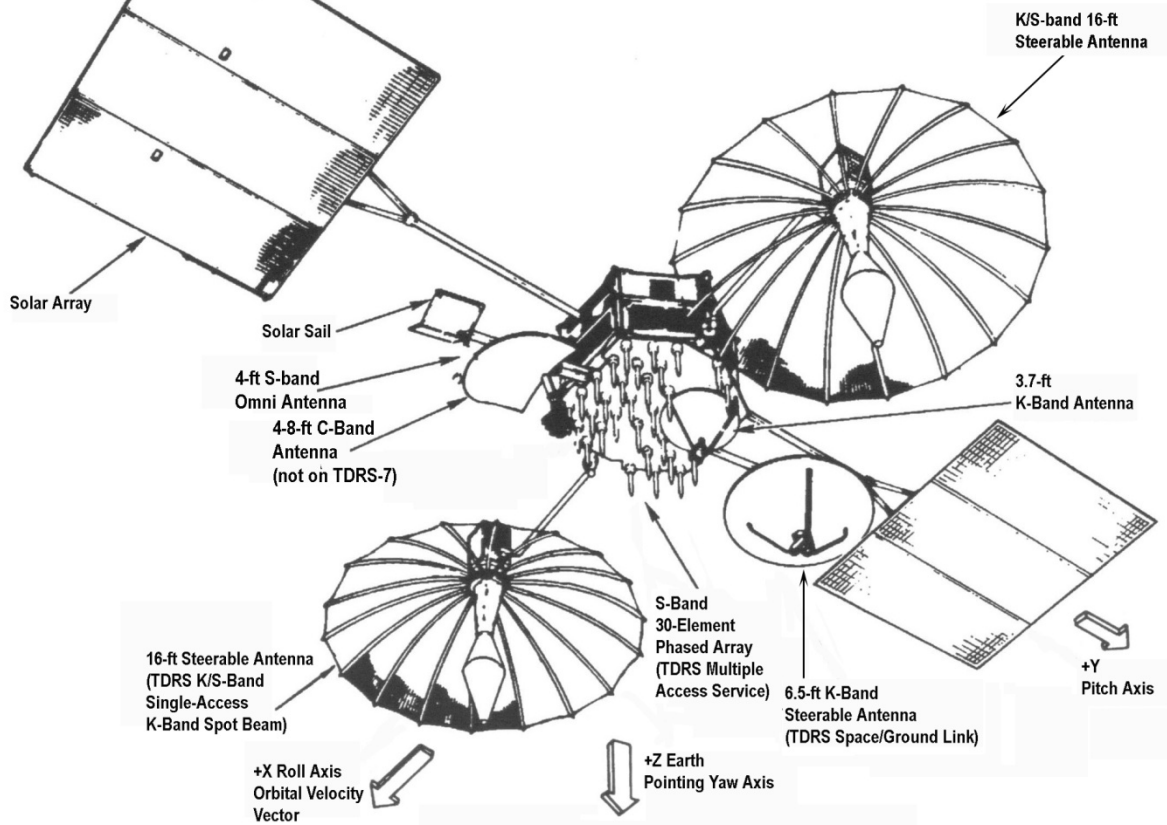

Figure 4-12. TDRS on-orbit configuration (Derived from STS-43 press kit).

For MA service, the multielement S-band phased array consisting of 30 helix antennas was hard-mounted on the spacecraft body on the surface of the antenna module facing Earth. The MA forward link (between the TDRS and user spacecraft) transmitted command data to the user spacecraft, and the return link sent the signal outputs separately from the array elements to the ground terminal's parallel processors. Signals from each helix antenna were received at the same frequency, frequency-division-multiplexed into a single composite signal, and transmitted to the ground. On the ground, the signal was demultiplexed and distributed to 20 sets of beam-forming

equipment that discriminated among the 30 signals to select the signals of individual users. The MA system used 12 of the 30 helix antennas on each TDRS to form a transmit beam.¹²⁹

The space-to-ground-link (STGL) antenna, a 6.5-foot (2-meter) parabolic reflector, provided the prime link for relaying transmissions to and from the ground terminal at Ku-band. The S-band omni telemetry, tracking, and communication antenna was used to control TDRS while it was in transfer orbit to geosynchronous altitude. Commercial K- and C-band antennas also transmitted and received data.¹³⁰ The D-shaped antenna to one side of the body, and the circular antenna on the face of the satellite were part of the Advanced Westar subsystem and were not used by the TDRSS. This equipment was carried on the first six satellites in the series even though it was not used. It was removed from TDRS-7, which replaced TDRS-B after it was destroyed in the *Challenger* accident.¹³¹ See tables 4-37 through 4-40 for further details.

¹²⁹ “Communications: Space Flight Tracking and Data Network,” <http://science.ksc.nasa.gov/shuttle/technology/sts-newsref/sts-jsc-comm.html> (accessed 22 March 2007).

¹³⁰ “STS-43 Press Information,” July 1991, Rockwell International Space Systems Division, p. 36, http://www.jsc.nasa.gov/history/shuttle_pk/mrk/FLIGHT_042-STS-043_MRK.pdf (accessed 28 September 2006).

¹³¹ Martin, p. 296.

Ground Segment

The Ground Segment supported the TDRSS. It provided the communications equipment needed to transmit and receive data, and track information relayed via each TDRS. The functions of the Ground Segment were to

- maintain each TDRS in a nominal (Ku-band) mode at all times and ensure that all on-board systems were properly configured and functioning within specified parameters;
- transmit forward link traffic from the ground to each TDRS for transmission to the designated customer spacecraft;
- receive and process customer spacecraft return link traffic from each TDRS, and format and transmit the data to the NASCOM (NISN) interface;
- monitor the state of health and control of the assigned TDRSs;
- measure the range of each assigned TDRS relative to the ground terminal;
- measure the closed-loop (two-way) range and Doppler or open-loop (one-way) Doppler for the customer spacecraft, and format and transmit the measured data to the NASCOM (NISN) interface;
- simulate the customer spacecraft for the purpose of system performance evaluation.¹³²

The Ground Segment consisted of two ground stations at the White Sands Complex (WSC) located within the White Sands Missile Range east of Las Cruces, New Mexico, and (beginning in 1998) the Guam Remote Ground Terminal (GRGT). The WSC was at a longitude with a clear line of sight to the satellites and was located in an area that received very little rain, because rain could interfere with the Ku-band uplink and downlink channels. The two ground stations at

¹³² “White Sands Complex,” <http://msp.gsfc.nasa.gov/tdrss/wsc.html> (accessed 11 September 2006).

White Sands—the White Sands Ground Terminal (WSGT) and the Second TDRSS Ground Terminal (STGT)—were functionally identical. They were independently operated ground terminals, and each housed a number of autonomous Space-Ground Link Terminals (SGLTs). WSGT contained two SGLTs, and STGT contained three SGLTs. The GRGT was an SGLT extended from and operated remotely via the WSGT.

Each SGLT contained the hardware and software needed to provide customer telecommunications and tracking services and tracking, telemetry, and command (TT&C) functions for the assigned TDRS. If a single SGLT became inoperative, only the TDRS and services supported by that SGLT would be affected. SGLT operations were controlled and monitored through the TDRSS Operations Control Center (TOCC). A data link, known as the Interfacility Link (IFL), existed between the WSGT and the STGT for the exchange of customer data and tracking information. The interface between WSGT and GRGT was accomplished by a commercial common carrier provided by NISN. Equipment was available at all three sites to provide customers with end-to-end system testing capabilities. Additional WSC functions included both data handling and unique support for the Space Shuttle.¹³³

Each SGLT could provide four SA forward and return customer telecommunication services and corresponding tracking services. Two of the three SGLTs within each ground terminal could support five MA return services (a total of 20 services between the two ground terminals) and one forward MA service per MA-equipped SGLT (a total of four MA forward services between the two ground terminals).

¹³³ Mission Services Program Office, *Space Network Users' Guide (SNUG), Revision 8* (Greenbelt, MD: Goddard Space Flight Center, 2002), p. 2-10, http://msp.gsfc.nasa.gov/tdrss/snug_main.pdf (accessed 10 October 2006). Also "White Sands Complex," <http://msp.gsfc.nasa.gov/tdrss/wsc.html> (accessed 11 September 2006).

The Network Control Center (NCC), originally located at Goddard, was the operational hub for the SN and GN. It also provided coordination functions with other network assets.¹³⁴ The NCC scheduled and configured the TDRSS and monitored the status of data that had been sent back for ongoing scheduled services. Operators scheduled emergency services, isolated any problems in the system, and restored faulty user services. The NCC could communicate with other ground tracking stations through NASCOM. Console operators monitored network performance, scheduled emergency interfaces, isolated faults in the system, accounted for system use, tested the system, and conducted simulations.¹³⁵ The STDN NCC scheduled all mission support activities and provided the interface for all STDN operations and network control activities.¹³⁶ The NCC Data System (NCCDS) was the primary computer system within the SN NCC. It provided the capability to plan and control use of the TDRSS in response to customer requests. In 1998, NASA issued a new version of the data system, called NCC 98.¹³⁷ The NCC was eliminated as a separate entity in 2002, and NASA moved its functions to a single control facility at White Sands and replaced it with the Data Services Management Center (DSMC). The DSMC provided support to both the SN and GN. The DSMC scheduled all SN elements and supporting elements, and provided interfaces for planning, acquisition, control, and status of the SN.

The NASA Ground Terminal (NGT) was colocated with WSGT. The NGT in combination with NASCOM was NASA's physical and electrical interface with the TDRSS. The NGT provided

¹³⁴ Jeffrey Glass, e-mail to author, 3 April 2007.

¹³⁵ "About Goddard > Resources," http://www.gsfc.nasa.gov/indepth/about_resources.html (accessed 29 March 2007).

¹³⁶ "Spaceflight Tracking and Data Network Facilities," <http://science.ksc.nasa.gov/shuttle/technology/sts-newsref/sts-jsc-comm.html> (accessed 4 June 2007).

¹³⁷ "What's NCC 98?" <http://ncc.gsfc.nasa.gov/ncc98/wnc98.htm> (accessed 14 September 2006). In FY 2002, NASA moved functions and interfaces supported by the NCC at Goddard to the Data Services Management Center (DSMC), which was colocated with the White Sands Complex. It supported both the SN and GN. Mission Services Program Office, *Space Network Users' Guide (SNUG), Revision 8* (Greenbelt, MD: Goddard Space Flight Center, 2002), pp. 2-10-2-11, http://msp.gsfc.nasa.gov/tdrss/snug_main.pdf (accessed 10 October 2006).

interfaces with the common carrier, monitored the quality of the service from the TDRSS, and remoted data to the NCC. It was abolished when the STGT became operational and was replaced by the Data Interface System (DIS).

The DIS provided a secure operational interface with the DSMC and automatic routing of customer data. The DIS could configure itself in response to the customer's service schedule. The DIS also provided data-quality monitoring, fault-detection management, and the interface to the NISN interface. Additionally, it provided the IFL between the WSGT and STGT used for the exchange of customer data and tracking information. The DIS replaced the NASA Ground Terminal (NGT) when STGT became operational.

The S-band TT&C System (STTCS) was used to provide contingency support to a TDRS in the event of an SGLT failure that precluded it from providing TT&C support to the TDRS. The STTCS also provided support to on-orbit spare TDRSs.

The Common Time and Frequency System (CTFS) generated and distributed highly accurate and stable timing and frequency references to the ground terminal elements. It provided the capability for time correlation with the United States Naval Observatory using cesium beam frequency standards and associated signal distribution equipment.

The Software Maintenance and Training Facility (SMTF) provided the capability for on-site development, enhancement, testing, and validating of ground terminal software, and training of operations staff and software maintenance personnel. The SMTF was also responsible for

configuration management and software quality assurance. The facility provided an environment that was similar to the actual ground terminal operational environment for training and software testing with the use of identical computer equipment. Console equipment and TDRS simulators were also provided to support operator training.¹³⁸

The Hardware Maintenance Depot (HMD) provided maintenance and testing for line-replaceable units that had been removed from operational equipment. Project management and systems engineering for the WSC were provided by the Space Network Project Office at Goddard.

In addition to the White Sands Complex, the Merritt Island Launch Area (MILA) TDRSS Relay provided RF signal routing between the TDRS and payloads or platforms under test before launch in support of Kennedy Space Center, Johnson Space Center, or customer mission operation centers. MILA also provided a relay between payloads and NISN facilities for the mission operation centers during the prelaunch period, when needed.¹³⁹

The WSGT was built in 1978 and became operational in 1983 when NASA launched TDRS-A. The WSGT building housed all of the equipment needed to operate the TDRSS, as well as space for the installation of mission-unique equipment. In 1988, NASA awarded a contract to GE Military and Data Systems Operations in Valley Forge, Pennsylvania, to design and install the hardware for a second TDRSS ground terminal (STGT), develop command and control software, and provide training to operating personnel. The STGT was dedicated in 1990 and completed in April 1994. The new ground terminal eliminated a critical single point of failure and added the

¹³⁸ *Space Network Users' Guide (SNUG)*, p. 2-10. "White Sands Complex," <http://msp.gsfc.nasa.gov/tdrss/wsc.html> (accessed 11 September 2006).

¹³⁹ *Ibid.*

necessary capability to operate additional TDRSs in the future when user demands for spacecraft would increase. It also allowed the WSGT to be taken out of service for modernization. STGT became fully operational on 10 March 1995 as the primary TDRSS ground terminal. Both stations operated until April 1995, when the WSGT was temporarily removed from service for modernization and the STGT assumed the full operations load. End-to-end systems-level tests of the modernized WSGT were completed in February 1996. It became fully functional in May, and technicians completed the modernization in June 1996, allowing the updated ground station to return to service. The two ground stations received Native American names as a result of a contest held among New Mexican students. The WSGT received the name Cacique, meaning “leader,” and the STGT received the name Danzante, meaning “dancer.”¹⁴⁰

A third NASA TDRSS ground terminal, located in Australia, operated from 1994 to 1998. In September 1992, NASA began constructing the GRO Remote Terminal System (GRTS) at Tidbinbilla in the Canberra DSN complex to support CGRO. CGRO had been designed to record data on tape recorders and downlink the recorded data through the geostationary TDRS-East and TDRS-West spacecraft in short bursts when it could point at either of the two satellites. Early in the mission, however, both on-board CGRO tape recorders had failed, necessitating continuous downlink of CGRO data as they were being encoded on the spacecraft. Valuable data were being lost because CGRO could relay only slightly more than half of its data. Because of the “zone of exclusion” over the Indian Ocean, the observatory could point at a TDRS about 65 percent of the time. It also lost data when it had to turn off its instruments as it passed through background

¹⁴⁰ *Aeronautics and Space Report of the President, 1989–1990 Activities*, pp. 39–40. Also “Space Communications Services,” Fiscal Year 1997 Estimates, p. MS 2-6; “TDRS-I Mission Press Kit,” NASA Goddard Space Flight Center, p. 10, http://www.gsfc.nasa.gov/gsfcearth/tdrs/tdrs_presskit.pdf (accessed 16 October 2006); *Aeronautics and Space Report of the President, Fiscal Year 1996 Activities*, p. 42; *Aeronautics and Space Report of the President, Fiscal Year 1993 Activities*, p. 35.

radiation caused by the South Atlantic Anomaly. Consequently, NASA decided to position TDRS-1 (then a spare satellite and redesignated TDRS Z) at 85°E longitude over the Indian Ocean. This would close the zone of exclusion and enable CGRO to transmit data 100 percent of the time. TDRS-Z began relaying data operationally on 6 December 1993 during the shift from its former location to its new one. It was in position by 7 February 1994.

This additional operational TDRS required an extra receiving station, and GRTS was built to support the satellite. The new ground station was declared operational on 1 April 1994, with a proficiency of more than 97 percent.¹⁴¹ The GRTS antennas (one 4.5 meters [14.8 feet] and one 11 meters [36.1 feet]) were in a fixed position and were also occasionally used to support Space Shuttle missions and the Hubble Space Telescope via TDRSS when they passed over the Indian Ocean and Australia.¹⁴² The station was used until 1998, when it was replaced by the Guam Remote Ground Terminal (GRGT). GRGT was considered part of the White Sands Complex, and was equipped with an 11-meter (36-foot) and a 4.5-meter (15-foot) antenna.

Advanced TDRSS

NASA anticipated that by the mid-1990s, the stock of spare spacecraft for the TDRSS would be exhausted, and the Agency began planning for the next TDRS series. The purpose of the new system, called Advanced TDRS (ATDRS), would be to maintain and augment the current TDRS system when available satellite resources were expended in the latter part of the 1990s, meet

¹⁴¹ *Aeronautics and Space Report of the President, Fiscal Year 1994 Activities* (Washington, DC: National Aeronautics and Space Administration, 1995), pp. 33–34.

¹⁴² Called the Ground Relay Tracking System in *Canberra Deep Space Communication Complex*, June 1997, p. 18, NASA History Division folder 8846, Historical Reference Collection, NASA Headquarters, Washington, DC. Also O'Brien and Tuohy, 8, and "NASA's GRO Remote Terminal System (GRTS), <http://project-tools.com/pages/grts1.htm> (accessed 28 September 2006).

evolving needs for satellite tracking and communications through 2012, and introduce new technology to reduce system life-cycle costs.¹⁴³ The ATDRS program (later called TDRS II) was to design, develop, and competitively procure technologically advanced satellites to sustain SN operations.

Initial studies were performed in 1986, and NASA released a Request for Proposal for contractors to perform ATDRS definition studies in 1990. The three participating contractors completed their studies in December 1991. The principal objectives were to minimize life-cycle costs and technical risks, and to develop transition procedures for integrating new capabilities at the ground terminals without interfering with ongoing operations.¹⁴⁴ However, the program was canceled in 1992. Instead, NASA decided to procure spacecraft that were functionally equivalent to the existing design as an interim solution to the need for additional communications satellites.

The TDRSS II program evolved into the TDRSS Replenishment program to develop TDRS-8 through TDRS-10. A firm fixed-price contract for the new series of three satellites, valued at \$486.1 million, was awarded in February 1995 to Hughes Space and Communications Company. In addition to hardware, the contract included management, development, integration and testing, shipment, launch support, and operations support of the spacecraft. The procurement marked the first time NASA had used a new and innovative acquisition method to maximize the quality and reliability of NASA hardware. Instead of developing detailed specifications that contractors were required to meet, NASA adopted commercial practices, identifying requirements and giving the

¹⁴³ *Aeronautics and Space Report of the President, 1989–1990 Activities*, p. 40.

¹⁴⁴ *Aeronautics and Space Report of the President, Fiscal Year 1991 Activities*, p. 44.

contractor flexibility to determine how to meet those requirements. The contractor was also held accountable for failures. In the event of a spacecraft failure, NASA would be reimbursed.¹⁴⁵

Work on the project began in July 1995 following resolution of a protest over the contract award. The first launch was scheduled for the third quarter of 1999 (later rescheduled to the fourth quarter). The Preliminary Design Review and Critical Design Review took place in 1996 and 1997, respectively. These reviews verified that the proposed contractor design would meet NASA performance requirements and that the contractor was prepared to proceed with manufacturing, assembly, integration, and test of the spacecraft. Integration and testing (I&T) of TDRS-H, the first spacecraft in the series, began in December 1997.¹⁴⁶ I&T for TDRS-J began in September 1998. TDRS-H launched in June 2000. The new spacecraft provided SA Ka-band forward and return service, which was useful for customers who needed extremely high data rates, and an enhanced MA capability that offered a greater number of MA links per spacecraft.¹⁴⁷ The satellites in this series were launched by ELVs rather than by the Shuttle.

Communications and Data Systems

The Communications and Data Systems program played a major role in transmitting and processing large volumes of data produced by NASA's operational spacecraft. Elements of the program linked the data acquisition stations and the scientific users and project facilities, and managed the operation, maintenance, and upgrading of facilities and systems for data processing and data transmission between remote tracking and data acquisition facilities, the TDRSS ground

¹⁴⁵ "NASA Awards \$481.6 Million Contract to Hughes," *NASA News Release 95-16*, 23 February 1995, <ftp://ftp.hq.nasa.gov/pub/pao/pressrel/1995/95-16.txt> (accessed 17 October 2006). Also "TDRSS: Tracking and Data Relay Satellite System," Mission and Spacecraft Library, <http://msl.jpl.nasa.gov/Programs/tdrss.html> (accessed 4 May 2007).

¹⁴⁶ "Space Communications Services," Fiscal Year 1999 Estimates, p. MS 2-6.

¹⁴⁷ "TDRS/TDRS H, I, J Baseline Service Comparison," <http://msp.gsfc.nasa.gov/tdrss/services.html> (accessed 11 September 2006). Also "Space Network Project; Code 452 NASA/GSFC," <http://scp.gsfc.nasa.gov/sn/spacesegment.htm> (accessed 14 September 2006).

terminals, launch areas, and mission control centers. Mission controllers required real time information to determine a spacecraft and payload's condition, respond to failures or dangerous situations, and generate spacecraft and payload control commands. Furthermore, data received from the spacecraft had to be transformed from their raw form into a form that would be useful for spacecraft monitoring and analysis by scientific investigators. This was all accomplished by NASA's Communications and Data System facilities and systems. During the decade, as new missions were added to the existing fleet of older spacecraft, and the volume of data being acquired increased exponentially, the capabilities required of these facilities and systems increased sharply.¹⁴⁸

Major system improvements during this decade included

- upgrading the data-handling capability of the DSN approximately fourfold;
- implementing a fiber-optic system to connect the two TDRSS ground terminals at the White Sands Complex;
- implementing a new backbone multiplexer/demultiplexer system between the White Sands Complex, Goddard Space Flight Center, and Johnson Space Center.¹⁴⁹

Communications

The Communications program consisted of two major networks: the NASA Communications (NASCOM) network and the Program Support Communications Network (PSCN). In 1995, these networks were integrated into NISN.¹⁵⁰

¹⁴⁸ "Communications and Data Systems," Space and Ground Networks, Communications and Data Systems, Fiscal Year 1989 Estimates, p. 3-20.

¹⁴⁹ "Communications and Data Systems," Space and Ground Networks, Communications and Data Systems, Fiscal Year 1993 Estimates, p. SF 4-21.

NASCOM

NASCOM was a global communications network that connected the tracking and data acquisition facilities that supported all flight projects by means of leased voice, data, and wideband circuits. It also linked various facilities, such as launch areas, test sites, and mission control centers, and provided links to mobile tracking stations. Goddard operated NASCOM and served as its major switching control point. The overseas elements of NASCOM used sub-switching centers at JPL and the Madrid DSN complex. Direct service from Madrid and the Canberra DSN complex to JPL was established in 1992 to economically provide the increased bandwidth required by new spacecraft. NASCOM also included the Agency's television service, NASA SELECT, which enabled the public to view all human spaceflight missions and learn about the achievements and discoveries of NASA's scientific missions.¹⁵¹

In 1991, NASCOM began working with the General Services Administration to transfer most of its voice/data and wideband services from dedicated point-to-point services to multiplexed dedicated transmission services using the Federal Telecommunications System (FTS) 2000 network.¹⁵²

In FY 1993, NASA completed an Interfacility Fiber-Optic Link (IFL) connecting the WSGT and the STGT in New Mexico. The link enhanced the exchange of operational data between those

¹⁵⁰ NASA Information Locator Record, "NASA Integrated Services Network," NASA-MSFC-01022, http://www.sti.nasa.gov/cgi-bin/gils_public.pl?Submit=Display&Control_Identifier=NASA-MSFC-01022 (accessed 21 March 2007).

¹⁵¹ "Communications and Data Systems," Space and Ground Networks, Communications and Data Systems, Fiscal Year 1993 Estimates, p. SF 4-22.

¹⁵² *Aeronautics and Space Report of the President, Fiscal Year 1991 Activities*, p. 45.

sites, increased ground terminal capacity, and improved the reliability of the expanded TDRS constellation that was being planned to meet the requirements for future data-intensive scientific missions. NASCOM also implemented the German Space Operations Center multiplexer system used for the German Spacelab mission (Spacelab D2) in April 1993. NASCOM established diversely routed circuits from Goddard to Germany, providing the data and voice capability for ground control operators in Germany to communicate with the astronauts on board the Shuttle.¹⁵³

In 1996, NASA extended networking services into Russia to meet the requirements of the International Space Station and other collaborative flight and scientific missions. This network implementation represented the first step toward achieving a single network that would satisfy both operational and programmatic requirements. Specifically, multiple wideband circuits were implemented between the United States and a NASA network gateway in Moscow. Connectivity was then established between the gateway and approximately 10 locations in Russia. The locations included the U.S. Embassy, Russian Space Agency, Moscow Mission Control Center, Gagarin Cosmonaut Training Center, and Institute of Space Research. Voice, data, video conferencing, and electronic mail services were available to users at all locations.¹⁵⁴

Program Support Communications Network

The PSCN provided administrative and data-handling services for NASA centers, NASA Headquarters, international space agencies, major contractors, university locations, and other domestic users to enable the transfer of program and scientific information. The system included computer networking, electronic mail and voice, and video teleconferencing. Marshall Space

¹⁵³ *Aeronautics and Space Report of the President, Fiscal Year 1993 Activities*, p. 35.

¹⁵⁴ "Space Communications Services," Fiscal Year 1997 Estimates, p. MS 2-11.

Flight Center operated the PSCN and served as its major switching control point. The network supported all NASA programs and projects, including robotic missions, the Space Shuttle, and the space station.¹⁵⁵ At the start of the decade, service was provided through leased voice, data, and wideband circuits. The network completed the transition to FTS 2000 in FY 1991.¹⁵⁶ Beginning in FY 1992, many domestic PSCN circuits were provided by the FTS 2000 program.

NASA Integrated Services Network

In 1995, in order to reduce costs and eliminate the duplication associated with separate programs, NASA began integrating the programmatic elements of its independent special purpose networks into NISN, replacing the independent special purpose networks that had previously served individual NASA customers for decades (the physical infrastructures remained separate).¹⁵⁷ NASCOM and PSCN were the first elements to be integrated into the new network. The NASA Science Internet (NSI) and Numerical Aerodynamic Simulation Network (NASnet), both located at Ames Research Center, were also merged into NISN. NISM became NASA's wide-area network provider, supplying mission and mission-support telecommunications services to all NASA centers, supporting contractor locations, international partners, research institutes, and universities.¹⁵⁸ Its goal was to transmit digital data, voice, and video information in the most cost-effective manner possible. By implementing NISN, NASA was able to eliminate the duplication between previous networks and to use new communications technology wherever it was appropriate. Most significantly, NASA looked to the commercial communications

¹⁵⁵ "Communications and Data Systems," Fiscal Year 1993 Budget Estimates, p. SF 4-22.

¹⁵⁶ *Aeronautics and Space Report of the President, Fiscal Year 1991 Activities*, p. 45.

¹⁵⁷ Richard Helmick, former NISN project manager, 21 March 2007.

¹⁵⁸ Services to non-NASA customers were provided on a reimbursable basis.

marketplace to provide services wherever they were cost-effective.¹⁵⁹ Marshall managed the network in partnership with Goddard.

Mission Control

The Mission Control program provided control and performance analyses of NASA's robotic Earth-orbiting spacecraft. The control facilities generated instructions for the spacecraft to make observations and measurements, monitor spacecraft status, and maneuver the spacecraft.¹⁶⁰ Each year, NASA provided tens of thousands of hours of mission control services to on-orbit science missions.

Data Processing

The Data Processing program included the Flight Dynamics Facility (FDF) and other major systems and facilities for processing payload data. The program's responsibilities included acquiring the equipment necessary to replace the DSN's ground communications data-handling capability with higher-capacity systems at the DSN complexes and the JPL. A data-processing facility, the Generic Time Division Multiplexer (GTDM) Facility, was completed in 1990 and processed data from satellites using time-division telemetry. The Packet Processor (PACOR) processed data from satellites using packet technology and protocols. The PACOR Data Processing Facility (DPF), also completed in 1990, was initially designed to meet the unique requirements of the Compton Gamma Ray Observatory (CGRO). The PACOR Facility used a new type of data protocol to ease spacecraft message handling. It replaced the Telemetry

¹⁵⁹ "Space Communications Services," Fiscal Year 1998 Estimates, pp. MS 2-7–MS 2-8. Also NASA Information Locator Record, NASA Integrated Services Network," NASA-MSFC-01022, http://www.sti.nasa.gov/cgi-bin/gils_public.pl?Submit=Display&Control_Identifier=NASA-MSFC-01022 (accessed 21 March 2007).

¹⁶⁰ *Aeronautics and Space Report of the President, 1989–1990 Activities*, p. 41.

Processing Facility once NASA spacecraft no longer used the GDTM approach. The PACOR system was upgraded to a distributed workstation environment to manage the increasing volume and rate of data processing.¹⁶¹ In FY 1992, the PACOR DPF was redesignated as a multi-satellite facility that would use packet data standards developed by the international Consultative Committee for Space Data Systems (CCSDS). The design was based on the use of power workstations, rather than large central computers, and Very Large Scale Integration microelectronics to enable high-speed processing that could not be achieved with software solutions.¹⁶²

In FY 1991, the Hubble Space Telescope (HST) began operations using a newly developed dedicated control center and data-capture facility. The HST Data-Capture Facility (HSTD CF) was the most complex facility to date for an automated satellite. It effectively handled Hubble's early on-orbit operations problems by modifying the ground and spacecraft software.¹⁶³ Other dedicated data-processing facilities, such as the International Solar Terrestrial Physics Data Capture Facility and the Spacelab Data Processing Facility (SLDPF), provided specialized data-processing services. A Central Data Acquisition Facility provided backup data-capture services, and the Data Distribution Facility produced electronic media and distributed NASA spaceflight data to interested users. Specialized telemetry processing systems for NASA's SN systems were also provided.¹⁶⁴ In October 1993, NASA refurbished the HSTD CF to be ready for the first Hubble Servicing Mission in December 1993.¹⁶⁵ In 1997, the HSTD CF was closed, and HST

¹⁶¹ "Mission Communication Services," Fiscal Year 1996 Budget Estimates, p. SAT 6-14.

¹⁶² *Aeronautics and Space Report of the President, Fiscal Year 1992 Activities*, p. 29.

¹⁶³ *Aeronautics and Space Report of the President, Fiscal Year 1991 Activities*, p. 45.

¹⁶⁴ "Communications and Data Systems," Fiscal Year 1993 Budget Estimates, p. SF 4-26. Also "Mission Communication Services," Fiscal Year 1996 Budget Estimates, p. SAT 6-15.

¹⁶⁵ *Aeronautics and Space Report of the President, Fiscal Year 1993 Activities*, p. 35.

science processing moved to the PACOR system. In FY 1995, the SLDPF, then located at Goddard, was consolidated successfully at Marshall, resulting in a cost savings of more than 50 percent for the processing of Spacelab and Shuttle-attached payloads data.¹⁶⁶

In a continuing effort to achieve efficiencies by adopting international space data systems standards, NASA agreed in FY 1992 that most new missions scheduled for launch after 1993 would use CCSDS-compatible telemetry systems. This would reduce the need for mission-unique hardware, software, and operating procedures. International partnerships in space activities would also benefit from adopting CCSDS standards by simplifying the sharing of operations functions and data among partners.¹⁶⁷

The **Flight Dynamics Facility**, located at Goddard, provided support in the areas of attitude determination, prediction, and control; expendable launch vehicle and Shuttle launch trajectory support; mission design, analysis, and orbit maneuvers; orbit determination and contact acquisition aids; and tracking station, network, and data evaluation. It provided expert tracking system performance evaluation, calibration, and validation for the SN and GN. The FDF also provided tracking data analysis on an as-needed basis for satellite projects supported by other networks, such as the DSN, DOD C-band radars, and the European Space Agency (ESA).

Mission support ranged from launch support for both expendable boosters and the Space Shuttle to science mission satellites in low-Earth orbit, geostationary orbiting weather satellites, and the

¹⁶⁶ *Aeronautics and Space Report of the President, Fiscal Year 1995 Activities* (Washington, DC: National Aeronautics and Space Administration, no date), p. 40.

¹⁶⁷ *Aeronautics and Space Report of the President, Fiscal Year 1992 Activities* (Washington, DC: National Aeronautics and Space Administration, 1993), p. 29.

TDRSS network. It also included Sun-Earth libration point missions, and lunar and deep-space probes. Experts formulated spacecraft attitude requirements and provided sensor performance and calibration analysis, telemetry evaluation, and operational attitude determination, prediction, and control. Other services included premission trajectory design and analysis, operational orbit control and maintenance, and extended mission trajectory redesigns as needed during a mission. This facility also provided premission orbit error analysis, tracking requirements analysis, and operational orbit determination and contact acquisition aids. Other services included tracking station and network trouble-shooting, transponder and link analysis, and tracking data evaluation.¹⁶⁸

Mission Facilities and Operations

The Mission Facilities and Operations program provided the systems and capabilities necessary to command and control uncrewed scientific satellites, and to operate the Payload Operations Control Centers (POCCs). It also provided the related software and support services needed to monitor and control on-orbit spacecraft and prelaunch preparations. Control facilities received, processed, and displayed spacecraft engineering and telemetry data. They generated commands in response to emergencies, as well as preplanned command sequences generated in advance to accomplish the mission objectives. Mission operations facilities were operated 24 hours per day, seven days per week.¹⁶⁹

The Extreme Ultraviolet Explorer (EUVE), launched in 1992, was the last spacecraft controlled from the aging Multi-Satellite Operations Control Center. SAMPEX, a Small Explorer mission

¹⁶⁸ “About the FDF; Flight Dynamics Facility,” <http://fdf.gsfc.nasa.gov/overview.htm> (accessed 3 October 2006).

¹⁶⁹ “Communications and Data Systems,” Fiscal Year 1991 Budget Estimates, p. SF 3-24.

launched in 1992, was the first spacecraft to be controlled using the Transportable Payload Operations Control Center (TPOCC) architecture, which consisted of distributed workstations. This concept allowed significant reuse of software (over 75 percent), resulting in lower costs, and took advantage of increased processing capability.¹⁷⁰ During the second half of the decade, NASA moved to consolidate functions, close marginal facilities, and reduce the overall contractor workforce. In 1997, EUVE and CGRO were phased into the TPOCC architecture. Goddard worked with the University of California–Berkeley (UCB) to install and test the TPOCC architecture in the EUVE Mission Operations Center. In 1998, EUVE operations were outsourced to UCB, in line with the 1996 national space policy stipulating that NASA would “seek to privatize or commercialize its space communications operations no later than 2005.”¹⁷¹ The transfer of EUVE to UCB and the relocation of CGRO processing to the workstation-based PACOR II resulted in the closure of the older PACOR I system.¹⁷²

Other mission control systems included the Shuttle POCC Interface Facility (SPIF) and the Command Management System. The SPIF provided a single interface to the Mission Control Center for Space Shuttle operations. The facility was successfully transitioned to the TPOCC architecture in 1997. The Command Management System generated all command sequences to be used by mission control centers to support spacecraft systems.¹⁷³

¹⁷⁰ “Communications and Data Systems,” Fiscal Year 1994 Budget Estimates, pp. SF 4-24–SF 4-25. Also *Aeronautics and Space Report of the President, Fiscal Year 1993 Activities*, p. 36.

¹⁷¹ “Mission Communication Services,” Fiscal Year 1997 Budget Estimates, p. SAT 5-11. Also the White House, National Science and Technology Council, “National Space Policy, Fact Sheet” 19 September 1996, <http://history.nasa.gov/appf2.pdf> (accessed 11 October 2006).

¹⁷² “Mission Communication Services,” Fiscal Year 2000 Budget Estimates, p. SAT 5-13.

¹⁷³ “Mission Communication Services,” Fiscal Year 1996 Budget Estimates, p. SAT 6-14.

CHAPTER 5: FACILITIES AND FIELD CENTERS

Introduction

During the first part of the decade of 1989 to 1998, NASA consisted of nine field centers, the contractor-operated Jet Propulsion Laboratory, a number of component facilities, and NASA Headquarters in Washington, DC. Four of the field centers, Ames Research Center, Langley Research Center, Lewis Research Center, and Dryden Flight Research Center, and one component facility—Wallops Flight Facility (part of Goddard Space Flight Center)—had been part of the National Advisory Committee for Aeronautics (NACA), NASA's predecessor. These facilities were transferred to NASA when the Agency was established in 1958. Three additional field centers, Goddard Space Flight Center, Kennedy Space Center, Marshall Space Flight Center, and the contractor-owned JPL were transferred to NASA from the U.S. military space program soon after. NASA established the National Space Technology Laboratories as a NASA center in 1974 and renamed it the Stennis Space Center (SSC) in 1988. Dryden was an independent center until 1981, when it became part of Ames Research Center. It regained its independent center status in 1994, becoming NASA's 10th field center. Figure 5-1 shows the locations of NASA's major centers and facilities. Figure 5-2 chronicles their establishment.

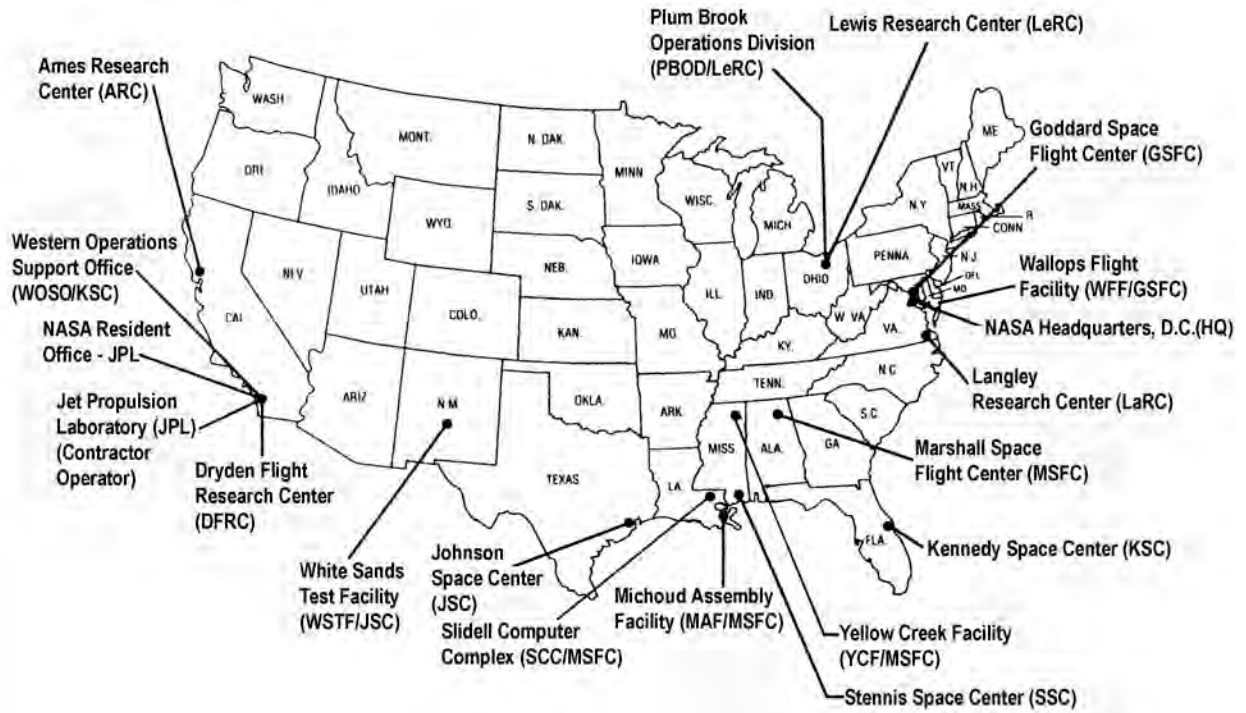

Figure 5-1. Major and Component NASA Field Centers (1994) (NASA Fiscal Year 1995 Budget Estimates).

Field Center	1989	1990	1991	1992	1993	1994	1995	1996	1997	1998
Ames Research Center	Authorized 1939 and named for NACA chair Joseph S. Ames; dedicated June 1940									
Dryden Flight Research Facility	Authorized 1952; named NACA High Speed Flight Station and made autonomous in July 1954; designated Flight Research Center in September 1959; renamed Dryden Flight Research Facility in March 1976; consolidated with Ames Research Center in October 1981 as Dryden Flight Research Facility					Became an independent NASA center in April 1994 as Dryden Flight Research Center				
Goddard Space Flight Center	Authorized 1958; dedicated in March 1961									
Jet Propulsion Laboratory	Organized 1944									
Johnson Space Center	Established in January 1961 as the Space Task Group; major occupancy of Clear Lake site in February 1964; renamed Johnson Space Center in February 1973									
Kennedy Space Center	Established in March 1962, effective in July 1962, as Launch Operations Center; redesignated Kennedy Space Center in December 1963									
Langley Research Center	Authorized 1917; dedicated in June 1920 and named Langley Memorial Aeronautical Laboratory in honor of									

	Samuel P. Langley; renamed Langley Aeronautical Laboratory in 1948; renamed Langley Research Center in 1958
Lewis Research Center	Established in 1941 as the Aircraft Engine Research Laboratory; renamed the Flight Propulsion Research Laboratory in April 1947; renamed Lewis Flight Propulsion Laboratory in 1948; renamed Lewis Research Center in 1958
Marshall Space Flight Center	Established in March 1960; transfer of personnel from U.S. Army effective in July 1960; dedicated in September 1960
Stennis Space Center	Established as the Mississippi Test Operations in October 1961; renamed the Mississippi Test Facility in 1965; established as an independent NASA center named the National Space Technology Laboratories in June 1974; renamed the Stennis Space Center in May 1988

Figure 5-2. NASA Centers (1989–1998).

Each NASA field center focuses its resources on particular major programs and mission areas. Beginning in 1996, each center was designated as a particular Center of Excellence. Table 5-1 lists these areas of concentration.

During this decade, changes in NASA's facilities and field centers consisted primarily of adding to and upgrading equipment, and increasing the number of buildings and other structures. Of the NASA centers, Ames Research Center at Moffett Field, California, was the only one to significantly increase the number of acres of land it controlled when the adjoining Moffett Naval Air Station closed and NASA took over the land and facilities. The only major organizational change made during the decade was that the Dryden Flight Research Facility, which had been a component of Ames, was returned to independent center status in 1994 and renamed the Dryden Flight Research Center.

The first part of this chapter reviews NASA's aggregate facilities, including the value and size of its total holdings and the centers' holdings grouped together for easy comparison. The second part of the chapter describes NASA Headquarters and the individual NASA centers that existed during all or part of the years from 1989 to 1998. It briefly describes their history and mission and also provides tables characterizing the property, personnel, funding, and procurement activity of each center during this period.

Aggregate Facilities

Definition of Terms

This discussion of facilities and field centers uses several terms with which the reader may be unfamiliar. The following definitions are derived from NASA Management Instructions and NASA Management Handbooks in use during the decade covered in this chapter.¹

Building: Facilities having the basic function to enclose usable space.

Capital Equipment: An item of equipment with an acquisition cost of \$5,000 or more that has an estimated service life of two years or more, that will not be consumed in an experiment, and that most generally will be identified as an independently operable item.

Centers: Primary NASA field entities, each led by a Center Director. Some centers have *component facilities*, which may be geographically separate from the parent center. Such facilities are led by a Manager or Head who reports to the parent center official. In most cases, the term “center” has replaced the term “installation.”

Collateral Equipment: Encompasses building-type equipment, built-in equipment, and large, substantially affixed equipment or property, and is normally acquired and installed as a part of a facility project. It includes the following:

¹ NASA Handbook (NHB) 4200.1D, *Equipment Management Manual*, April 1992. NHB 8800.15, *Real Estate Management Program Implementation Handbook*, October 1991. NASA Policy Directive (NPD) 8820.2, *Design and Construction of Facilities*, December 2, 1998. NASA Procedures and Guidelines (NPG) 8820.2B, *Facility Project Implementation Handbook*, April 27, 1997. NHB 8831.2A, *Facilities Maintenance and Energy Management Handbook*, 31 December 1996. Note: except for NPD 8820.2, all directives and guidelines listed have been canceled. They are cited because they were in effect during the period being discussed in this chapter.

- **Building-Type Equipment:** Equipment that is normally required to make a facility useful and operable. It is built in or affixed to the facility in such a manner that removal would impair the usefulness, safety, or environment of the facility. Such equipment includes elevators, heating, ventilating, and air-conditioning systems, transformers, compressors, and other like items generally accepted as being an inherent part of a building or structure and essential to its utility. It also includes general building systems and subsystems such as electrical, plumbing, pneumatic, fire protection, and control and monitoring systems.
- **Built-in or Large, Substantially Affixed Equipment or Property:** The unit of equipment or property of any type other than building-type equipment that is built in, affixed to, or installed in real property in such a manner that the Center cost, including special foundations or unique utility services or facility restoration work required after its removal, exceeds \$100,000.

Component Facilities: Organizations geographically separate from the NASA centers to which they are assigned. During this decade, NASA's component facilities and the centers to which they were assigned included:

- Deep Space Network (Goldstone, California; Canberra, Australia; and Madrid, Spain) (JPL)
- Downey Facility (DF) (California) (JSC) (closed in 1999)
- Ground Network at Kennedy Space Center (GSFC)
- Independent Verification and Validation Facility (IV&V) (West Virginia) (GSFC)
- Michoud Assembly Facility (MAF) (MSFC)
- NASA Management Office (NMO)/JPL (HQ/Code S)
- Palmdale (California) (JSC)

- Plum Brook Station (PBS) (Ohio) (LeRC)
- Santa Susana Field Laboratory (California) (MSFC)
- Slidell Computer Complex (MSFC) (transferred to the City of Slidell, Louisiana, December 14, 1994)
- Space Network (White Sands, New Mexico) (GSFC)
- Wallops Flight Facility (Wallops Island, Virginia) (GSFC)
- White Sands Test Facility (WSTF) (Las Cruces, New Mexico) (JSC)

Equipment: An item of real or personal property, generally in the configuration of a mechanical, electrical, or electronic apparatus or tool, normally costing in excess of \$100, that may perform a function independently or in conjunction with other equipment or components. Includes collateral equipment, general purpose equipment, special test equipment, ground support equipment, and other special purpose equipment, such as automatic data processing equipment, data control consoles, and instrumentation that may or may not be capitalized.

Facility: Land, buildings, structures, and other real property improvements, including utility systems and collateral equipment permanently affixed to land. The term does not include operating materials, supplies, special tooling, special test equipment, and noncapitalized equipment. The term “facility” is used in connection with land, buildings (facilities having the basic function to enclose usable space), structures (facilities having the basic function of a research or operational activity), and other real property improvements. The term “facility” is synonymous with “real property.”

Fixed Assets: Assets of a permanent character having a continuing value, such as land, buildings, and other structures and facilities, including collateral and noncollateral equipment meeting the criteria for capitalization.

Integral Equipment: Equipment normally required to make a facility useful and operable as a facility and built in or permanently affixed to it in such a manner that removal would impair the usefulness, safety, or comfort of the facility.

Investment Value: A figure representing the total of real property value (including land, buildings, and other structures and facilities), leasehold improvements value, capitalized equipment value, and assets-in-progress value.

Land: A category of real property including all acquired interests in land (for example, owned, leased, or acquired by permit) but excluding NASA-controlled easements and rights-of-way included under leasehold improvements.

Leased Property: Property under the control of NASA through lease, administrative agreement, temporary permit, licensee, or other arrangements.

Leasehold Improvement: Includes NASA-funded costs of long-term capital improvements (more than three years) to leases, rights, interests, and privileges relating to land not owned by NASA, such as easements, right-of-ways, permits, use agreements, water rights, air rights, and mineral rights. The cost of short-term (three years or less) rights, interests, and privileges relating to such

land are charged to the operating cost of a facility project as appropriate. Leasehold improvements also include NASA-funded costs of improvements made to land, buildings, and other structures and facilities not owned by NASA.

Noncollateral Equipment: Noncollateral equipment imparts to the facility or test apparatus its particular character at the time, e.g., furniture in an office building, laboratory equipment in a laboratory, test equipment in a test stand, machine tools in a manufacturing facility, or computers in a building that is useful or operable (as a structure or building). Such equipment, when acquired and used in a facility or a test apparatus, can be severed and removed after erection on Center, without substantial loss of value or damage thereto or to the premises where installed.

Other Structures and Facilities: A category of real property that includes facilities having the basic function of research or operational tools or activities as distinct from buildings. The category includes items such as airfield pavements; harbor and port facilities; power production facilities and distribution systems; reclamation and irrigation facilities; flood control and navigation aids, storage, industrial service, and research and development facilities other than buildings; utility systems (heating, sewage, water, and electrical) when they serve several buildings and/or structures; communications systems; traffic aids, roads, and bridges; railroads; monuments and memorials; and other nonstructural improvements such as sidewalks, parking areas, and fences. This also includes all equipment of any type built in, affixed to, or installed in such a manner that the installation cost, including special foundations or unique utilities or services, or the facility restoration cost after removal, is substantial.

Personal Property: Property of any kind, including equipment, materials, and supplies, but excluding real property.

Real Property: Land, buildings, structures, utility systems, and improvements and appurtenances permanently annexed to land. Also includes collateral equipment (i.e., building-type equipment, built-in equipment, and large substantially affixed equipment).

NASA Property Statistics

Tables 5-2 through 5-17 include statistics for 1989–1998 on NASA real property, investment values, land, buildings, other structures, and capitalized equipment.

Headquarters and Field Centers

In the following pages the mission and history of each NASA center are briefly described, and their directors and deputy directors are listed. Table 5-18 details the 1998 budget plan by field center and program office. The tables that follow list the property holdings and their value, personnel levels and characteristics, funding levels, and procurement activity for each field center. The names and dates of center directors and deputy directors who served between 1989 and 1998 come from official biographies, personnel announcements, and press releases, as well as from information provided by center personnel. Director and deputy director names and dates for the period before 1989 come from earlier volumes of the *NASA Historical Data Book*.

NASA Headquarters

Location

From the time the Agency was established in 1958 until October 1961, NASA Headquarters was located in the “Little White House” at 1520 H Street NW in Washington, DC. Built in 1820 by Richard Cutts, the house was also called the Dolly Madison House because the widow of President James Madison had lived there from 1837 until her death in 1849. In the fall of 1961, NASA moved its Headquarters to Federal Office Building 6 at 400 Maryland Avenue SW in Washington, sharing it with the Department of Education. In 1963, NASA Headquarters expanded into Federal Building 10-B at 600 Independence Avenue SW and the Reporters Building at 300 7th Street SW. It also occupied space at L’Enfant Plaza in southwest Washington, and other locations in the city. In July 1990, NASA broke ground for a new Headquarters that would house all Headquarters staff. This nine-story building, known as Two Independence Square, is located at 300 E Street in the southwest quadrant of the city.² Most of the staff gradually moved into the 450,000-square-foot (41,806-square-meter) building during 1992 and 1993. The remaining staff members were temporarily housed at One Independence Square and moved into the new building by the end of September 1995.³

Administrator (1958–1998)

Daniel S. Goldin, April 1992–November 2001

Richard H. Truly, May 1989–March 1992

James C. Fletcher, May 1986–April 1989

² One Independence Square, a similar building next door, housed the Comptroller of the Currency.

³ “NASA Center: Headquarters,” <http://grin.hq.nasa.gov/ABSTRACTS/GPN-2002-000092.html> (accessed November 8, 2006). Also memo (Independence News) from Paula Geisz to NASA staff, September 21, 1994. (NASA History Office NASA History Division folder 4533, Historical Reference Section, NASA Headquarters, Washington, DC.

William R. Graham (acting), December 1985–May 1986

James Beggs, July 1981–December 1985⁴

Alan M. Lovelace (acting), January 1981–July 1981

Robert A. Frosch, June 1977–January 1981

James C. Fletcher, April 1971–May 1977

George M. Low (acting), September 1970–April 1971

Thomas O. Paine, March 1969–September 1970

James E. Webb, February 1961–October 1968

T. Keith Glennan, August 1958–January 1961

Deputy Administrator (1958–1998)

John R. Dailey (acting), November 1992–December 1999

Aaron Cohen (acting), February 1992–November 1992

James R. Thompson, Jr., July 1989–November 1991

Dale D. Myers, October 1986–May 1989

William R. Graham, November 1985–October 1986

Hans Mark, July 1981–September 1984

Alan Lovelace, July 1976–December 1980

George M. Low, December 1969–June 1976

Thomas O. Paine, March 1968–March 1969

Robert C. Seamans, Jr., December 1965–January 1968

Hugh L. Dryden, September 1959–December 1965

⁴ James Beggs went on an indefinite leave of absence beginning 4 December 1985 while he was answering charges of fraud alleged to have occurred while he was Executive Vice President of General Dynamics Corporation. He was cleared of all charges.

History

During the decade from 1989 through 1998, several changes occurred in Headquarters-level organizations that reflected the changing priorities of the Agency. A detailed description of major HQ-level organizations can be found in the appropriate chapters of this book and volume VII.

Many of the changes that occurred during this decade reflected the importance of the Space Shuttle program and the developing space station. At the start of the decade, the Office of Space Flight, which was responsible for all facets of the Space Shuttle program, and the Office of Space Station were two separate organizations. In December 1989, they were consolidated into a single organization because of the close relationship of the two programs (most space station components would be launched using the Shuttle and assembled by astronauts on-orbit). In 1990, on the recommendation of an advisory committee headed by Norman Augustine, development of the planned Space Station Freedom was moved to a new organization—the Office of Space Systems Development. This organization was also responsible for developing other large propulsion and launch systems and planning other advanced transportation systems. The scaled-down Office of Space Flight continued to focus on Space Shuttle operations and retained responsibility for space station and Spacelab operations and utilization, expendable launch vehicle (ELV) operations, and upper stages. This change lasted only until October 1993, when NASA Administrator Daniel Goldin returned responsibility for the Space Station program to the Office of Space Flight.

In 1992, a new organization, called the Office of Advanced Concepts and Technology, was formed that incorporated the Space Technology program and former Office of Commercial Programs, which disbanded. In September 1994, this office and the Office of Space Systems Development were consolidated into a new Office of Space Access and Technology. This office focused on developing new transportation systems, such as a reusable launch vehicle (RLV), and was also the interface with other government agencies and the commercial sector.

During this period, the Space Station Program Office was centered in Reston, Virginia, about 25 miles (40 kilometers) from NASA Headquarters. This office, headed by a director, was responsible for day-to-day management, developing the space station, ensuring the operational capability of its flight and ground systems, and controlling internal and external interfaces. Individual field centers, which reported to the office at Reston, and several international partners were responsible for developing the various space station components. However, in October 1993, following the redesign of the space station, management of the space station moved from Virginia to Johnson Space Center in Houston. The new program office had all implementation responsibilities and employees were invited to relocate to the new site from Virginia.

NASA's science programs also reorganized during this decade. In October 1992, the Office of Space Science and Applications (OSSA) split into the Office of Space Science and the Office of Mission to Planet Earth, effective in March 1993. In March, a separate Office of Life and Microgravity Sciences and Applications (OLMSA) was established from OSSA's Life Sciences and Microgravity divisions. OLMSA focused on the effects of long-duration spaceflight on humans and other living creatures, as well as on microgravity and other life-science areas.

Reducing the size of Headquarters and moving the management of as many programs as possible to the field centers were also priorities. In October 1996, a major agencywide restructuring took place that merged the Office of Space Communications, which managed Agency network and tracking activities, into the Office of Space Flight. The Office of Space Access and Technology was disbanded, and work on developing an RLV was moved to the Office of Aeronautics and Space Transportation Technology. Johnson Space Center had lead responsibility for Space Shuttle program management.

In February 1995, NASA moved to a Strategic Enterprise structure, as described in its 1995 Strategic Plan. Five Strategic Enterprises were formed to provide a framework for strategic planning at the Agency: (1) Mission to Planet Earth (MTPE), (2) Aeronautics; (3) Human Exploration and Development of Space, (4) Space Science, and (5) Space Technology.⁵ The 1996 Strategic Plan deployed a new “Centers of Excellence” approach to streamline and consolidate the Agency’s technical capabilities.⁶ In the Strategic Management Handbook, published in October 1996, the Space Technology enterprise was eliminated.⁷ The functions of this enterprise were transferred to the Aeronautics enterprise, which in 1996 was renamed the Aeronautics and Space Transportation enterprise (soon shortened to the Aero-Space Technology enterprise).

Table 5-19 lists the major organizations at Headquarters in 1989 and in 1998.

⁵ *NASA Strategic Plan*, February 1995, <http://www.hq.nasa.gov/office/codez/stratplans/1995/Enterprises.html> (accessed November 9, 2006).

⁶ *NASA Strategic Plan*, February 1996, <http://www.hq.nasa.gov/office/codez/stratplans/1996/cover.html> (accessed November 9, 2006).

⁷ *NASA Strategic Management Handbook*, October 1996, <http://www.hq.nasa.gov/office/codez/strahand/frontpg.htm> (accessed November 9, 2006).

Mission

NASA Headquarters provides the organizational structure for the entire Agency and is responsible for the overall planning, coordination, and control of NASA programs. Headquarters consists of program offices in charge of planning and directing agencywide research and development programs and management and administrative processes; staff offices that provide agencywide leadership in certain administrative and specialized areas; and the Office of the Associate Deputy Administrator. Strategic Enterprise management at Headquarters manages individual NASA centers and programs. In addition, other offices with specific functions, such as the Office of the Chief Engineer, Office of the Chief Scientist, and Office of Policy and Plans, have been established and disbanded over time. The head of each office reports directly to the Administrator, who is appointed by the President.

The mission of the Office of Inspector General (OIG) is to prevent crime, fraud, waste, and abuse in government programs. Public Law 95-452, known as the Inspector General Act of 1978, created independent audit and investigative units, called Offices of Inspector General (OIGs), at 61 federal agencies. At NASA, the OIG conducts objective oversight of NASA programs and operations and independently reports to the Administrator, Congress, and the public to further the Agency's accomplishment of its mission. The OIG is funded by Congress separately from NASA's other activities and consists of four offices: Audits, Investigations, Counsel, and Management and Planning. The mandate of the OIG, as stated in the Act, is to:

- conduct and supervise independent and objective audits and investigations relating to Agency programs and operations;
- promote economy, effectiveness, and efficiency within the Agency;

- prevent and detect crime, fraud, waste, and abuse in Agency programs and operations;
- review and make recommendations regarding existing and proposed legislation and regulations relating to Agency programs and operations;
- keep the Agency head and the Congress fully and currently informed of problems in Agency programs and operations.⁸

Tables 5-20–5-23 provide data about Headquarters facilities, personnel, funding, and procurements.

⁸ “NASA OIG Mandate, Mission and Guiding Principles,” <http://oig.nasa.gov/mission.html> (accessed December 11, 2006).

Ames Research Center

Location

Ames Research Center is located at the south end of San Francisco Bay, approximately 35 miles southeast of San Francisco and 10 miles northwest of San Jose. It was adjacent to the U.S. Naval Air Station at Moffett Field, California, when the base was active. When the base closed in 1993, Ames absorbed the air station.

Director

Henry McDonald, March 1996–September 2002

Ken Munechika, January 1994–March 1996

Dale L. Compton, December 1989–January 1994

Dale L. Compton (acting), July 1989–December 1989

William F. Ballhaus, Jr., February 1989–July 1989

Dale L. Compton (acting), February 1988–February 1989

William F. Ballhaus, Jr., January 1984–February 1988

Clarence A. Syvertson, April 1978–January 1984

Clarence A. Syvertson (acting), August 1977–April 1978

Hans Mark, February 1969–August 1977

H. Julian Allen, October 1965–February 1969

Smith J. De France, October 1958–October 1965

Deputy Director

William E. Berry, October 1997–April 2002

William E. Berry (acting), February 1997–September 1997

William E. Dean, July 1994–January 1997

William E. Dean (acting), January 1994–July 1994

Victor L. Peterson, March 1990–January 1994

Victor L. Peterson (acting), July 1989–March 1990

Dale Compton, February 1989–July 1989

Victor L. Peterson (acting), February 1988–January 1989

Dale Compton, January 1985–February 1988

Angelo Guastafarro, October 1980–January 1985

A. Thomas Young, February 1979–February 1980

Clarence A. Syvertson, February 1969–April 1978

History

Ames Research Center was established in 1939 as the second laboratory of the National Advisory Committee for Aeronautics (NACA).⁹ Its original name was the Moffett Field Laboratory. In 1944, the center was renamed the Ames Aeronautical Laboratory in honor of Joseph S. Ames, chair of NACA from 1927 to 1939, former president of Johns Hopkins University, and a leading authority on aerodynamics. Ames became part of NASA in 1958 and was renamed Ames Research Center. In 1981, NASA merged Ames with the Dryden Flight Research Center. The two field centers were then referred to as Ames-Moffett and Ames-Dryden. In March 1994, Dryden once again became an independent NASA center.

⁹ “Ames History,” <http://www.nasa.gov/centers/ames/about/history.html> (accessed October 23, 2006).

On December 22, 1993, NASA and the U.S. Navy signed a MOU under which Moffett Naval Air Station land would be transferred to NASA. The agreement implemented recommendations made by the Defense Base Closure and Realignment Commission in July 1991 concerning future use of the land on which the air station was located.¹⁰ On 1 July 1994, Moffett Field was closed as a military base. Supervision of Moffett's facilities, two runways, and three aircraft hangars was turned over to Ames. NASA serves as the host agency for the federal facility, which is occupied by more than 10,000 active-duty military, civilian, and military reserve personnel.¹¹

Mission

Ames Research Center participates in a wide range of programs. Its program areas include computer science and applications, computational and experimental aerodynamics, flight simulation, flight research, hypersonic aircraft, rotorcraft and powered-lift technology, aeronautical and space human factors, life sciences, space sciences, solar system exploration, airborne science and applications, and infrared astronomy. The center also supports military programs, the Space Shuttle, and various civil aviation projects, and focuses on meeting the needs of the U.S. aerospace industry.

Prime areas of flight research at Ames include icing research; transonic model testing; aerodynamics research; flying qualities, stability and control, and performance evaluations; variable-stability aircraft; gunsight tracking and guidance and control displays; inflight thrust reversing and steep approach research; boundary-layer control research; short takeoff and

¹⁰ Del Harding, "Agreement Reached To Transfer Navy Land to Ames," *Astrogram*, 8 January 1993, p. 1, NASA History Division folder 4563, Historical Reference Section, NASA Headquarters, Washington, DC.

¹¹ "NASA Ames Director To Take Top Moffett Field Post," Ames News Release 96-7, 17 January 1996, NASA History Division folder 4563, Historical Reference Section, NASA Headquarters, Washington, DC.

landing (STOL) and vertical and short takeoff and landing (V/STOL) aircraft research; and rotorcraft research.¹² Ames has housed several wind tunnels, including the largest wind tunnel in the world. Restoration of the 12-foot (6.5-meter) Pressure Wind Tunnel, which was built in 1946, was completed in 1994 after four years of work. The tunnel has been used to test models of most U.S. commercial aircraft in service over the past 50 years. (See chapter 3 of this volume for a description of the Ames wind tunnels.)

Ames is NASA's lead center for astrobiology, focusing on research to determine the effects of gravity on living creatures. The center plays a major role in efforts to understand the origin, evolution, and distribution of stars, planets, and life in the universe; in ecosystem and atmospheric science in support of Earth science projects; and in developing thermal protection systems for future access to space and for planetary atmospheric entry vehicles.¹³ Tables 5-24 through 5-28 provide data about Ames.

¹² Paul F. Borchers, James A. Franklin, Jay W. Fletcher, *Flight Research at Ames, 1940–1997* (Washington, DC: NASA SP-3300, 1998), p. 2. (Available at <http://history.nasa.gov/SP-3300/sp3300.htm>.)

¹³ "NASA Headquarters and Centers," *NASA Spinoff 1997*, <http://www.sti.nasa.gov/tto/spinoff1997/contents.html> (accessed November 7, 2006).

Dryden Flight Research Center

Location

Dryden Flight Research Center is located at the north end of Edwards Air Force Base, California, in the Mojave Desert approximately 80 miles (130 kilometers) north of the Los Angeles metropolitan area. It occupies 838 acres under a permit from the U.S. Air Force. Dryden is adjacent to Rogers Dry Lake, a 44-square-mile (114-square-kilometer) natural surface used for Shuttle landings and aviation research and test operations. Nearby Rosamond Dry Lake provides an additional 22 square miles (57 square kilometers) of similar smooth clay surface. The desert environment offers good flying weather an average of 345 days a year, and the absence of large population centers throughout the high desert helps eliminate problems associated with aircraft noise and flight patterns.¹⁴

Director

Kevin L. Petersen (acting), August 1998–February 1999

Kenneth J. Szalai, Director, March 1994–July 1998

Kenneth J. Szalai, Ames Deputy Director and Dryden Facility Director, December 1990–March 1994

Martin Knutson, Director of Flight Operations and Site Director, Ames-Dryden Flight Research Facility, May 1984–December 1990

Martin A. Manke, Director of Flight Operations, Ames Research Center (after Dryden was consolidated with Ames as the Ames-Dryden Flight Research Facility), October 1981–April 1984

¹⁴ “Dryden Flight Research Center,” Fact Sheet, <http://www.nasa.gov/centers/dryden/news/FactSheets/FS-001-DFRC.html> (accessed October 23, 2006).

Isaac T. Gillam IV, June 1978–September 1981
Isaac T. Gillam IV (acting), October 1977–June 1978
David R. Scott, August 1977–October 1977
David R. Scott (acting), April 1975–August 1977
Lee R. Scherer, October 1971–January 1975
Paul F. Bikle, September 1959–May 1971
Walter C. Williams, October 1958–August 1959

Deputy Director

Kevin Peterson, January 1996–July 1998¹⁵
Kevin Peterson (acting), April 1994–January 1996
Robert P. Johannes, December 1979–October 1980
John Boyd, January 1979–December 1979
Isaac T. Gillam IV, August 1977–June 1978
William H. Rock, November 1975–January 1976
David R. Scott, August 1973–November 1975
D. E. Beeler, April 1958–August 1973

History

The U.S. Army originally used the Dryden area as a bombing and gunnery range before World War II. In July 1942, the Army established a formal air base near the town of Muroc, California. The first NACA group of engineers, technicians, and support staff arrived at Muroc from

¹⁵ “NASA Administrator and Center Directors Biographies,” <http://www.nasa.gov/centers/dryden/news/Biographies/Directors/index.html> (accessed October 23, 2006).

Langley Research Center in 1946 on temporary assignment. In early 1947, the contingent became known as the NACA Muroc Flight Test Unit and the site was made a permanent facility, under Langley management. The group used Muroc as a test site when it designed and built a research aircraft to break the sound barrier.¹⁶

In 1949, Muroc was renamed Edwards Air Force Base. Also that year, the name of the NACA facility was changed to the NACA High Speed Flight Research Station. It became an autonomous facility in 1954, reporting directly to NACA headquarters. In March 1976, the center became the Hugh L. Dryden Flight Research Center, in honor of Hugh L. Dryden, the internationally renowned aerodynamicist who had been NACA's director from 1947 to 1957. In October 1981, the center's independent status was removed and it was redesignated the Dryden Flight Research Facility under the administration of the Ames Research Center. It returned to independent status in March 1994. The change meant that Dryden could work directly within NASA at senior management levels, and that decisions and communication no longer needed to go through the extra level of management at Ames.

Dryden is home to a varied fleet of research and support aircraft and is the only NASA center that is able to test aircraft in real world situations (as opposed to the artificial environment of wind tunnels and computer models).¹⁷ The center's facilities include a high-temperature and loads-calibration laboratory to ground-test aircraft and structural components for the combined effects of loads and heat, a highly developed aircraft flight instrumentation capability, a flow-

¹⁶ Wallace Lane, *Flights of Discovery: 50 Years at the NASA Dryden Flight Research Center* (Washington, DC: NASA SP-4309, 1996), p. 3.

¹⁷ Allison Gatlin, "Dryden Returns to Independence," *Antelope Valley Press*, March 1, 1994 NASA History Division folder 004576, Historical Reference Section, NASA Headquarters, Washington, DC.

visualization facility to study flow patterns on models and small aircraft components, a data-analysis facility to process flight research data, and a facility for flight research with remotely piloted vehicles.

Dryden's Research Aircraft Integration Facility (RAIF), which became operational in 1992, is the only facility of its type at NASA. It has been used to carry out simultaneous checks of flight controls, avionics, electronics, and other systems on a variety of aircraft. The facility was designed to speed up and enhance systems integration and preflight checks on all types of research aircraft. Working in this facility gives Dryden pilots, engineers, scientists, and technicians a unique and highly specialized capability to conduct flight research programs.¹⁸

Mission

Dryden's mission is to perform flight research and technology integration to revolutionize aviation, pioneer aerospace technology, validate space exploration concepts, conduct airborne remote sensing and science missions, and support operations of the Space Shuttle and the International Space Station. It participated in the approach and landing tests of the Space Shuttle orbiter *Enterprise*, serves as a backup Shuttle landing site, is used as a facility to test and validate design concepts and systems used to develop and operate the orbiters, and processes the orbiter for ferry flights back to the launch site.¹⁹ Research thrusts in the 1990s have included high-speed research, remotely piloted research vehicles, high-performance aircraft operation, and less costly access to space.²⁰ Tables 5-29 through 5-33 provide data about Dryden.

¹⁸ "Dryden Flight Research Center," Fact Sheet, <http://www.nasa.gov/centers/dryden/news/FactSheets/FS-001-DFRC.html> (accessed October 23, 2006).

¹⁹ "About Dryden," <http://www.nasa.gov/centers/dryde-bout/Dryden/mission.html> (accessed November 9, 2006).

²⁰ Wallace, pp. 158–159.

Goddard Space Flight Center

Location

Goddard Space Flight Center is located in Greenbelt, Maryland, approximately 10 miles (16 kilometers) northeast of Washington, DC. In addition to its main site, until FY 1981, Goddard leased 620 acres of nearby land from the Department of Agriculture for the Goddard Antenna Test Range, Magnetic Test Facility, Optical Tracking and Ground Plane Test Facility, Bi-Propellant Test Facility, and Network Test and Training Facility. In 1981, 544 acres of this land were transferred to Goddard. The remaining land stayed with the Department of Agriculture. Goddard also manages the Goddard Institute for Space Studies (GISS) in New York City, which was established in 1961. Since October 1981, Goddard's facilities have included the Wallops Flight Facility (which formerly was an independent center) on Wallops Island on the eastern shore of Virginia.

Director

Alphonse V. Diaz, January 1998–August 2004

Joseph H. Rothenberg, October 1995–January 1998

John Klineberg, July 1990–April 1995

John W. Townsend, Jr., June 1987–June 30, 1990

Noel W. Hinnners, June 1982–June 1987

Leslie H. Meredith (acting), March 1982–June 1982

A. Thomas Young, February 1980–March 1982

Robert E. Smylie (acting), June 1979–February 1980

Robert Cooper, August 1976–June 1979

John F. Clark, May 1966–August 1976

Harry J. Goett, September 1959–July 1965

Deputy Director

William F. Townsend, March 1998–September 2004

Vacant, January 1998–March 1998

Alphonse V. Diaz, February 1996–January 1998

Vacant, July 1995–February 1996

Joseph H. Rothenberg, April 1995–July 1995

Thomas E. Huber, July 1994–March 1995

Peter T. Burr, February 1991–July 1994

Vacant, January 1988–February 1991 (James H. Trainor, Associate Director)

John J. Quann, September 1982–January 1988

John McElroy, September 1980–September 1982

Robert E. Smylie, December 1976–February 1980

Donald P. Hearth, April 1970–September 1975

Vacant, July 1968–April 1970

John W. Townsend, July 1965–July 1968

History

In August of 1958, Senator J. Glenn Beall of Maryland announced that the federal government would establish a “Space Projects Center” in Greenbelt, Maryland. On January 15, 1959, the NASA Administrator established the Beltsville Space Center on land that was originally part of

the Department of Agriculture's Beltsville Agricultural Research Center.²¹ On May 15, the center was formally renamed the Goddard Space Flight Center "in commemoration of Dr. Robert H. Goddard, American pioneer in rocket research." It was the first facility built specifically for the new Agency.²² The first 157 Goddard employees, who were working on the Vanguard project, transferred from the Naval Research Laboratory in Washington.

From NASA's early days, Goddard managed the facilities of the Space Tracking and Data Network (STDN), a series of tracking stations located around the world. At its height during the late 1970s and the early days of the Shuttle program, the network consisted of approximately 20 stations worldwide. The number of stations decreased as the Tracking and Data Relay Satellite System (TDRSS), also managed by Goddard, became operational; however, the STDN continued to support missions that could not be tracked by the TDRSS and provided additional Shuttle tracking support. (See chapter 4 for a description of NASA's tracking activities.) The center was also responsible for robotic spacecraft and sounding-rocket experiments in basic and applied research, and managed development and launch of the Thor-Delta launch vehicle.²³

The Goddard facility at Greenbelt covers 1,270 acres. It maintains the adjacent Magnetic Test Facility and Propulsion Research site and outlying sites, including the Antenna Performance Measuring Range and the Optical Tracking and Ground Plane Facilities. The unique Magnetic Test Facility is a magnetic quiet area and is operated from a single control building. Other unique facilities at Goddard include the Flight Dynamics Facility and a high-capacity centrifuge that is

²¹ "Goddard Space Flight Center," NASA Facts, September 1991.

²² *Ibid.*, p. 1.

²³ "Goddard Space Flight Center (GSFC)," <http://www.history.nasa.gov/centerhistories/goddard.htm> (accessed 15 November 2006).

capable of rotating 5,000-pound (2,268-kilogram) payloads at up to 30 revolutions per minute. In 1990, the Space Systems Development and Integration Facility, an 86,000-square-foot (7,989.4-square-meter) building used to integrate and test space hardware, opened.²⁴ This facility houses the 1.3 million-cubic-foot (36,811.76-cubic-meter) High Bay Clean Room.²⁵

In the second half of the 1990s, Goddard added two large facilities to its campus. The Earth Observing System Data and Information System building officially opened in July 1995. This facility is a data-compilation center for spacecraft dedicated to the Earth Observing System (EOS), the largest segment of NASA's Earth science program. It is also used to compile data from other Earth science data sources. It has the largest Data Active Archiving Center (DAAC) and is the center for all real time EOS operations. The building has approximately 190,000 square feet (17,650 square meters) of office and data-processing/archiving space, housing state-of-the-art equipment. Late in 1998, the Earth System Science Building (ESSB) opened. This building provides technical facilities and support space to conduct interdisciplinary Earth science research on a worldwide scale for the EOS program.²⁶

An important part of Goddard Space Flight Center is the Wallops Flight Facility (WFF), which had been an independent NASA center but was consolidated with Goddard on October 19, 1981, becoming the Suborbital Projects and Operations Directorate of Goddard Space Flight Center.

²⁴ "Goddard Space Flight Center (GSFC)," <http://www.history.nasa.gov/centerhistories/goddard.htm> (accessed November 15, 2006).

²⁵ "Hubble Space Systems Development and Integration Facility," <http://sm3a.gsfc.nasa.gov/ssdif.html> (accessed April 30, 2007).

²⁶ NASA Office of Inspector General, "Management Controls on the Earth Science Building (ESSB) Contract," Audit Report IG-98-015, June 8, 1998, <http://oig.nasa.gov/audits/reports/FY98/pdfs/ig-98-015.pdf> (accessed November 7, 2006).

WFF is located on Wallops Island, off the Delmarva Peninsula in Virginia, and on additional nearby property on the Virginia mainland.

Wallops is one of the oldest launch sites in the world. Wallops Flight Center was established in 1945 by NACA when it authorized the Langley Research Center to develop Wallops Island as a site for research with rocket-propelled models and as a center for aerodynamic research. Before NASA was established in 1958, the facility helped build the foundation for aerodynamic and heat-transfer research by providing a high-speed aeronautics launch site that used rockets to propel aircraft models. The facility allowed researchers to overcome the limited capabilities offered by the wind tunnels of the day.

Research conducted at Wallops includes developing components for the human space program, such as capsule-escape techniques, maximum-pressure tests, and recovery systems. Wallops provides range support for research in reentry and life-support systems, Scout launch vehicles, and mobile research projects. It also has expanded its scope to include Earth studies of ocean processes, and uses the Wallops Research Airport for runway surface and aircraft noise reduction studies. Wallops uses relatively small solid rockets staged in various ways to meet the propulsion requirements of its research tasks. The largest and most sophisticated of its launch vehicles was the Scout four-stage solid-fuel vehicle, which could launch small scientific satellites, space probes, and reentry missions.

Goddard Institute for Space Studies

The Goddard Institute for Space Studies (GISS), located at Columbia University in New York City, conducts basic research in space and Earth sciences in support of Goddard's programs by working cooperatively with New York area universities and research organizations. The institute focuses particularly on the study of global change, including long-range climate, biogeochemical cycles, and planetary atmospheres. Research at GISS combines analysis of comprehensive global datasets with global models of atmospheric, land surface, and oceanic processes. Past events on Earth, as well as other planets, are examined to aid in predicting the future evolution of Earth.

Independent Verification and Validation Facility

Located in Fairmont, West Virginia, the NASA Independent Verification and Validation (IV&V) Facility was established in 1993 as part of an agencywide strategy to provide the highest achievable level of safety and cost-effectiveness for mission-critical software. It was founded under the NASA Office of Safety and Mission Assurance as a result of recommendations made by the National Research Council and the Report of the Presidential Commission on the Space Shuttle *Challenger* accident.²⁷

Mission

Goddard Space Flight Center's mission is to expand our knowledge of Earth and its environment, the solar system, and the universe through the development and use of near-Earth-orbiting spacecraft. It is responsible for supporting NASA's role in space and Earth sciences; conducting research and applying technology for sensors, instruments, and information systems;

²⁷ "NASA Goddard Space Flight Center," NASA Facts, FS-2005-5-071-GSFC, http://www.nasa.gov/centers/goddard/pdf/118885main_FS-2005-5-071-GSFC_finalv2.pdf (accessed November 9, 2006).

planning and executing spaceflight projects for scientific research; and tracking Earth satellites by means of a worldwide communications system.

The Wallops Flight Facility mission includes managing and implementing NASA's sounding-rocket and balloon programs, conducting observational Earth sciences studies, providing flight services for scientific investigations, and operating the Wallops Test Range and Orbital Tracking Station. Tables 5-34 through 5-38 provide data about Goddard.

Jet Propulsion Laboratory (JPL)

Location

The JPL's main site is at the foot of the San Gabriel Mountains near Pasadena, California, approximately 12 miles (32 kilometers) northeast of Los Angeles. At Pasadena, the Laboratory occupies 177 acres of land. At Goldstone, California, Deep Space Network facilities are located on land occupied under permit from the U.S. Army. At Edwards Air Force Base, facilities are located on land occupied under permit from the U.S. Air Force. The facilities at Table Mountain are located on land occupied under permit from the Forest Service of the Department of Agriculture.²⁸

Director

Edward C. Stone, January 1991–January 2001

Lew Allen, Jr., July 1982–December 31, 1990

Bruce C. Murray, April 1976–June 1982

William H. Pickering, October 1958–March 1976

Louis Dunn, 1946–1954

Frank Malina, 1944–1946

Theodore von Kármán, 1944 and forerunner organization

Deputy Director

Larry N. Dumas, July 1992–2001

Peter T. Lyman, July 1987–July 1992

²⁸ "Jet Propulsion Laboratory," NASA History Division folder 4527, Historical Reference Section, NASA Headquarters, Washington, DC.

Robert J. Parks, January 1984–September 1987

Charles H. Terhune, Jr., 1969–December 1983

History

JPL is a government-owned, contractor-operated facility that is staffed and managed by the California Institute of Technology (Caltech). It dates back to the 1930s, when Theodore von Kármán, head of the Guggenheim Aeronautical Laboratory at Caltech, oversaw pioneering work in rocket propulsion. After the Caltech group performed successful rocket experiments, the Army helped Caltech acquire land in the Arroyo Seco near Pasadena, California, for rocket tests and workshops. The term “Jet Propulsion Laboratory” was first used during World War II to refer to a group of researchers in a proposed project headed by von Kármán to analyze the German V-2 program. During the war years, teams of rocket engineers tested small unguided missiles, experimented with radio telemetry, and began planning for ground radar and radio sets. By 1945, the group had begun launching test vehicles from White Sands, New Mexico, to an altitude of 200,000 feet (60,960 meters). Researchers continued developing missiles that could fly and survive in the field under stressful conditions, as well as a supersonic wind tunnel and an array of environmental test technologies.²⁹

JPL flew the first successful U.S. space mission, Explorer 1, on January 31, 1958. On 3 December 1958, JPL was transferred from Army jurisdiction to NASA control. NASA’s contractual arrangement with Caltech for research and development at JPL dates from 1962. The

²⁹ “Jet Propulsion Laboratory,” NASA Facts, http://www.jpl.nasa.gov/news/fact_sheets/jpl.pdf (accessed 9 November 2006).

NASA Management Office in Pasadena administers the contract.³⁰ A series of “space-related” and laboratory buildings were constructed in the 1960s. New building projects have continued, including several laboratory buildings in the 1980s and 1990s. Its main campus is approximately 177 acres in size.³¹

Major missions at JPL during the decade from 1989 to 1998 included the Mars Observer, Topex/Poseidon (with the French space agency), Magellan, Galileo, Mars Pathfinder (a Discovery program mission), Mars Global Surveyor, Cassini-Huygens, Mars Climate Orbiter, and Mars Polar Lander. It also built several instruments for NASA’s MTPE missions.³² Details of these missions can be found in chapter 4 (“Space Science”) of volume VII of the *NASA Historical Data Book, 1989–1998*, and in chapter 2 (“Earth Science and Applications”) of volume VIII of the *Data Book*.

Mission

JPL is NASA’s lead center for robotic exploration of the solar system. Its major programs involve exploring Earth and the solar system, managing the Deep Space Network for communications, data acquisition, mission control, and radio-science space study, and performing basic and applied scientific and engineering research. Its spacecraft have visited all known planets except Pluto. In addition to its work for NASA, JPL conducts tasks for a variety of other federal agencies. Tables 5-39 to 5-42 provide data about JPL.

³⁰ “Jet Propulsion Laboratory,” NASA Facts, http://www.jpl.nasa.gov/news/fact_sheets/jpl.pdf (accessed November 9, 2006). Also “Jet Propulsion Laboratory,” <http://history.nasa.gov/centerhistories/printFriendly/jpl.htm> (accessed November 13, 2006).

³¹ “Jet Propulsion Laboratory,” NASA Facts, http://www.jpl.nasa.gov/news/fact_sheets/jpl.pdf (accessed November 9, 2006).

³² “JPL History: The 80s,” <http://www.jpl.nasa.gov/jplhistory/the80/index.php> and “JPL History: The 90s,” <http://www.jpl.nasa.gov/jplhistory/the90/index.php> (accessed May 1, 2007).

Johnson Space Center

Location

Johnson Space Center is located at Clear Lake, Texas, about 20 miles (32 kilometers) southeast of downtown Houston. Additional facilities are located at Ellington Air Force Base, approximately 7 miles (11 kilometers) north of the main facility. It also manages the White Sands Test Facility, a component facility near Las Cruces, New Mexico.

Director

George W. S. Abbey, January 1996–February 2001

George W. S. Abbey (acting), August 1995–January 1996

Carolyn Huntoon, January 1994–August 1995

Paul J. Weitz (acting), August 1993–January 1994

Aaron Cohen, October 1986–August 1993

Jesse Moore, January 1986–October 1986

Robert Goetz (acting), January 1986 (two-week duration)

Gerald Griffin, August 1982–January 1986

Christopher C. Kraft, Jr., January 1972–August 1982

Robert R. Gilruth, November 1961–January 1972

Deputy Director

James D. Wetherbee, August 1995–April 2000

George Abbey, January 1994–August 1995

Paul J. Weitz, December 1986–January 1994

Robert C. Goetz, July 1983–October 1986

Charles E. Charlesworth, August 1979–May 1983

Sigurd A. Sjoberg, January 1972–May 1979

Christopher C. Kraft, Jr., November 1969–January 1972

George S. Trimble, October 1967–September 1969

George M. Low, February 1964–April 1967

James C. Elms, November 1963–February 1964

History

Johnson Space Center was established in September 1961 as the Manned Spacecraft Center in response to the need for a center to manage the design, development, and manufacture of crewed spacecraft; to select and train astronaut crews; and to conduct human spaceflight missions. It was renamed Lyndon B. Johnson Space Center in February 1973. The complex includes approximately 100 buildings on a 1,620-acre site. Its specialized training facilities include Shuttle simulators, the Space Shuttle Orbiter Trainer, the Manipulator Development Facility, the Precision Air Bearing Facility, Space Station mockups, and the Weightless Environment Training Facility.³³

The White Sands Test Facility, a component center of Johnson, was established in 1962 at Las Cruces, New Mexico, to test Apollo propulsion and power systems. It supports spacecraft propulsion checkout, power system evaluations, and materials testing. Much of the land used by NASA at this facility is owned by the U.S. Army or the Bureau of Land Management.

³³ “Lyndon B. Johnson Space Center,” *1997 Spinoff*, www.sti.nasa.gov/tto/spinoff1997/ar5.html (accessed November 7, 2006).

Ellington Field is responsible for center flight operations. The aircraft based there include a KC-135 four-engine jet used to produce space-like weightlessness, a specially modified twin-engine Gulfstream that performs like a landing shuttle orbiter, and T-38 jet trainers flown by astronauts to maintain their proficiency.³⁴

Johnson is also responsible for the Palmdale facility in Palmdale, California, and until 1999 it was in charge of the Downey Facility in Downey, California. Both of these facilities, operated by Rockwell International/Rocketdyne (later Boeing), were used to manufacture and assemble various parts of the Space Shuttle. The Downey facility was closed in 1999 in an effort to reduce costs. The majority of work performed at Downey was transferred to Boeing's Huntington Beach, California, facility.³⁵

Mission

Johnson Space Center has program management responsibility for the Space Shuttle program. It is home to the Astronaut Corps and is responsible for training people from the United States and abroad who will be traveling in space. It also has a major responsibility for developing the International Space Station (ISS) and is responsible for the interfaces between the ISS and Space Shuttle, and the flight operations of both. Its areas of expertise include the fields of space systems, engineering, life sciences, and lunar and planetary geosciences, and it participates in medical, scientific, and engineering experiments.³⁶ Additionally, Johnson manages the

³⁴ "Lyndon B. Johnson Space Center (JSC)," <http://history.nasa.gov/centerhistories/johnson.htm> (accessed November 13, 2006).

³⁵ *Audit Report, Impact of the Boeing Company's Restructuring on NASA*, November 27, 2000, IG-01-006, p. 5, <http://www.hq.nasa.gov/office/oig/hq/audits/reports/FY01/ig-01-006.pdf> (accessed December 11, 2006).

³⁶ "Lyndon B. Johnson Space Center," NASA Facts, NASA History Division folder 4703, Historical Reference Section, NASA Headquarters, Washington, DC.

development, testing, production, and delivery of various types of hardware, such as power systems, crew equipment, electrical power generation and distribution, navigation and control, cooling systems, structures, flight software, robotics, spacesuits, and spacewalking equipment.³⁷

Tables 5-43 through 5-47 provide data about Johnson.

³⁷ “Lyndon B. Johnson Space Center (JSC),” <http://history.nasa.gov/centerhistories/johnson.htm> (accessed November 13, 2006).

Kennedy Space Center

Location

John F. Kennedy Space Center is located on the east coast of Florida, immediately north and west of Cape Canaveral, midway between Jacksonville and Miami, and approximately 45 miles (72 kilometers) east of Orlando. The center consists of 140,000 acres encompassing more than 20 major facilities. The environmentally unique federal property coexists with the Merritt Island National Wildlife Refuge and is home to more than 500 species of wildlife, including 21 (as of 1997) on threatened or endangered lists.³⁸

Director

Roy D. Bridges, March 1997–June 2003

Jay F. Honeycutt, January 1995–March 1997

Robert L. Crippen, January 1992–January 1995

Forrest McCartney, October 1986–December 1991

Thomas E. Utsman (acting), July 1986–October 1986

Richard G. Smith, September 1979–July 1986

Lee R. Scherer, January 1975–September 1979

Kurt H. Debus, March 1962–October 1964

Deputy Director

James L. Jennings, August 1997–May 2000, Deputy Director for Business Operations

Loren J. Shriver, July 1997–April 2000, Deputy Director for Launch and Payload Processing

³⁸ *Annual Report FY 1997*, Kennedy Space Center, p. 13, http://www.nasa.gov/centers/kennedy/pdf/66712main_annrpt97.pdf (accessed November 13, 2006).

James L. Jennings (acting), January 1997–August 1997

James A. (Gene) Thomas, January 1990–January 1997

Thomas E. Utsman, August 1985–January 1990

Horace Lamberth (acting), November 1984–August 1985

George F. Page, July 1982–October 1984

Gerald D. Griffin, July 1977–August 1981; on Headquarters assignment July 1980–May 1981

Miles Ross, June 1970–May 1977

Miles Ross, July 1970–1977, Deputy Director

Miles Ross, September 1967–March 1970, Deputy Director for Operations

Albert F. Siepert, September 1967–March 1970, Deputy Director for Center Management

Albert F. Siepert, April 1963–September 1967

History

The site of Kennedy Space Center had been used as a missile launching ground since the late 1940s. In 1951, it was used for test flights of the U.S. Army's Redstone intermediate-range ballistic missile. In January 1953, its name was changed from the Long-Range Proving Ground to the Missile Firing Laboratory. In July 1960, it became part of NASA's Marshall Space Flight Center's Launch Operations Directorate. The directorate was disbanded in March 1962.

Congress approved the development of Cape Canaveral, the strip of land on Florida's east coast, in 1961, soon after President John F. Kennedy announced plans to fly American astronauts to the Moon. In August 1961, NASA announced its intention to expand the Cape Canaveral facilities for piloted lunar flight and other missions requiring advanced Saturn and Nova boosters by

acquiring 80,000 acres of land north and west of the Air Force Missile Test Center facilities at the Cape.³⁹ NASA began acquiring land across the Banana River from Cape Canaveral in 1962, taking title to 83,894 acres by outright purchase. It negotiated with the state of Florida for use of an additional 55,805 acres of state-owned submerged land, most of which lies within the Mosquito Lagoon. The investment in property reached approximately \$71,872,000. In July 1962, the Launch Operations Directorate at the Cape was separated from the Marshall Space Flight Center by executive order. It became the Launch Operations Center, an independent NASA installation.⁴⁰

Construction of NASA's Vehicle Assembly Building began in July 1963 and was substantially completed early in 1966. At the time of its construction, it was the largest building in the world, with an enclosed area of 129,482,000 cubic feet (3,666,522 cubic meters) and a height of 525.8 feet (160.3 meters) to the top of the finished roof of its high bays. It was constructed with 98,590 tons of steel and 65,000 cubic yards (49,696 cubic meters) of concrete.⁴¹

President Johnson renamed both the Launch Operations Center and the Cape Canaveral Auxiliary Air Force Station the John F. Kennedy Space Center seven days after the President was assassinated. NASA Administrator James Webb officially issued a similar order changing the name of NASA's facility on December 20, 1963. The U.S. Department of the Interior's Board of Geographical Names changed the name of the geographical cape from Cape Canaveral

³⁹ "Historical Timeline, 1960s" Kennedy Space Center, <http://www.nasa.gov/centers/kennedy/about/history/timeline/1950.html> (accessed May 1, 2007).

⁴⁰ *Kennedy Space Center Story*, chapter 1, <http://www.nasa.gov/centers/kennedy/about/history/story/ch1.html> (accessed May 2, 2007).

⁴¹ "Historical Timeline, 1960s" Kennedy Space Center, <http://www.nasa.gov/centers/kennedy/about/history/timeline/1950.html> (accessed May 1, 2007).

to Cape Kennedy the following year. In May 1973, after almost 10 years, Florida Governor Reuben Askew signed a legislative enactment restoring the name of the geographic cape to Cape Canaveral. The Department of the Interior's Board of Geographical Names followed suit in October.⁴²

In May 1964, the Air Force Atlantic Missile Range at Cape Canaveral, which is adjacent to the northern part of Merritt Island and has been used since the early 1950s, was redesignated the Eastern Test Range. It would be the site of the Mercury and Gemini launches.

By 1967, Kennedy Space Center's Complex 39 was operational. The complex was strategically located next to a barge site and consisted of a variety of structures, including a vehicle assembly building, processing facilities, press site, crawlerways to Complex 39 launch pads, and the Launch Control Center. On November 9, 1967, Pad A, one of the two new launch pads at Launch Complex 39, was used for the first time to launch the first Saturn V on Apollo 4, the first Apollo launch. Between 1967 and 1973, 13 Saturn V launches (12 Apollo missions and the first Skylab space station) took place at Kennedy. Three three-member Skylab missions were also launched from Kennedy aboard Saturn 1Bs in 1973. The Saturn-Apollo era ended in 1975 with the launch of a Saturn IV/Apollo crew on the Apollo Soyuz Test Project, a joint mission with the Soviet Union.

The Shuttle Landing Facility (SLF), which was specifically designed for returning Space Shuttle orbiters, was first used in 1976. Longer and wider than the runways at most commercial airports,

⁴² "Historical Timeline, 1970s" Kennedy Space Center, <http://www.nasa.gov/centers/kennedy/about/history/timeline/1970.html> (accessed May 1, 2007).

the paved runway was 15,000 feet (4,572 meters) long, with a 1,000-foot (305-meter) overrun on each end. In 1979, an Orbiter Processing Facility was built, and the Orbital Flight Test Program began at Kennedy. NASA launched the first Shuttle mission from Kennedy on April 12, 1981.⁴³ All of NASA's Space Shuttle missions, as well as hundreds of expendable launch vehicle (ELV) missions, have been launched from Kennedy. ELV operations are conducted at both the Air Force's Eastern Space and Missile Center at Cape Canaveral Air Force Station, Florida, and the Western Space and Missile Center at Vandenberg Air Force Base, California, located 6 miles (9.6 kilometers) west of Lompoc, California.

During the 1980s and 1990s, several new facilities were added for solid rocket booster processing, Shuttle logistics, orbiter modification and refurbishment, and repair and final manufacture of thermal protection system materials. In addition to the SLF and the Orbiter Processing Facility, major facilities involved in Shuttle launch and landing include the Thermal Protection System Facility, Logistics Facility, Launch Equipment Test Facility, Multi-Payload Processing Facility, Spacecraft Assembly and Encapsulation Facility 2, Space Station Processing Facility, Vertical Processing Facility, Solid Rocket Booster Processing Facility, Vehicle Assembly Building, Launch Control Center, and a variety of transportable equipment and facilities.⁴⁴ In September 1991, a third Orbiter Processing Facility bay was dedicated. The former Orbiter Modification and Refurbishment Facility, which had been used for off-line orbiter inspection, modifications, and repair work, was converted using existing service structures and work platforms transported to Kennedy from Vandenberg Air Force Base, NASA's West Coast

⁴³ "Kennedy Space Center," <http://www.sti.nasa.gov/tto/spinoff1997/ar6.html> (accessed November 7, 2006).

⁴⁴ "Countdown," Information Summary, <http://www-pao.ksc.nasa.gov/kscpao/nasafact/pdf/Countdown2005.pdf> (accessed November 7, 2006).

launch site.⁴⁵ In June 1994, the Space Station Processing Facility (SSPF), which serves as the central preflight checkout and processing point for elements of the International Space Station, was dedicated. Construction of the 457,000-square-foot (42,457-square-meter) facility had begun in April 1991. The facility includes clean rooms and supporting control rooms and laboratories for processing Space Station elements, and office space to accommodate more than 1,000 employees. The first piece of hardware to be processed for flight in the SSPF, the Russian Docking Module, arrived at Kennedy on June 7, 1995.⁴⁶

Mission

Kennedy Space Center has primary responsibility for ground turnaround and support operations, prelaunch checkout, and launch of the Space Shuttle and its payloads, including the ISS. The center's responsibility also extends to the facilities and ground operations at Vandenberg Air Force Base in California and designated contingency landing sites. It is also the prime center for payload testing and checkout.⁴⁷ In October 1997, Kennedy was designated the lead center for acquisition and management of ELV Services for the Agency. The Kennedy team manages all NASA ELV launches from Cape Canaveral Air Force Station, Vandenberg Air Force Base, Kodiak Island in Alaska, Kwajalein Island in the Pacific, and elsewhere.⁴⁸

In August 1998, the repainting of the Vehicle Assembly Building began in celebration of NASA's upcoming 40th anniversary on 1 October. It was the first time that the American flag,

⁴⁵ "Historical Timeline, the 1990s," Kennedy Space Center, <http://www.nasa.gov/centers/kennedy/about/history/timeline/1990.html> (accessed May 1, 2007).

⁴⁶ Ibid.

⁴⁷ "Kennedy Space Center," <http://www.sti.nasa.gov/tto/spinoff1997/ar6.html> (accessed November 7, 2006).

⁴⁸ "Historical Timeline, the 1990s," Kennedy Space Center, <http://www.nasa.gov/centers/kennedy/about/history/timeline/1990.html> (accessed May 1, 2007).

which was originally added to the building in celebration of America's 200th birthday in 1976, had been repainted. The Bicentennial emblem was replaced with the NASA logo.⁴⁹ Tables 5-48 to 5-52 provide data about Kennedy.

⁴⁹ Ibid.

Langley Research Center

Location

Langley Research Center is located at Langley Field in Hampton, Virginia, between Norfolk and Williamsburg, Virginia, and approximately 135 miles (217 kilometers) southeast of Washington, DC. Its campus covers 788 acres, plus 20 acres “permitted” by Langley Air Force Base. Under a permit from the Department of the Interior, Langley has access to 3,276 acres.⁵⁰ The campus includes 220 buildings (in 2000).⁵¹

Director

Jeremiah F. Creedon, August 1996–June 2002

Paul F. Holloway, October 1991–August 1996

Richard H. Petersen, November 1984–December 1991

Donald P. Hearsh, September 1975–November 1984

Edgar M. Cortright, May 1968–September 1975

Floyd L. Thompson, May 1960–May 1968

Henry J. E. Reid, October 1958–May 1960

Deputy Director

H. Lee Beach, Jr., December 1991–July 1998⁵²

Paul F. Holloway, February 1985–October 1991

⁵⁰ *Media Guide and Public Affairs Contacts*, June 1989, p. 25, NASA History Division folder 4527, Historical Reference Section, NASA Headquarters, Washington, DC.

⁵¹ “NASA Langley Research Center: Revolutionizing Aerospace for the Millennium,” FS-2000-06-27-LaRC, June 2000 (accessed October 15, 2000); replaced by 2004 update: <http://oea.larc.nasa.gov/PAIS/FS-2004-02-84-LaRC.html> (accessed November 16, 2006).

⁵² “Beach Named Langley Deputy Director,” *NASA News Release* 91-198, December 4, 1991, <http://www.nasa.gov/home/hqnews/1991/91-198.txt> (accessed November 16, 2006).

Richard H. Petersen, July 1980–November 1984

Oran W. Nicks, November 1970–July 1980

Charles J. Donlan, November 1967–May 1968

History

In 1916, NACA selected a site near Hampton, Virginia, for Langley Field, its experimental air station named after Samuel Pierpont Langley, the third secretary of the Smithsonian Institution and an aeronautical pioneer. Construction of the Langley Memorial Aeronautical Laboratory, the first national civil aeronautics laboratory, began in 1917. Until 1940, Langley was the only NACA laboratory. In 1948, NACA changed the laboratory's name to the Langley Aeronautical Laboratory. When NASA was formed in 1958, it was renamed Langley Research Center.

In 1958, NASA selected Langley to manage Project Mercury, the first U.S. human spaceflight project. Heading the project was Langley's Space Task Group, a group of NASA employees who led the original seven astronauts through the initial phases of their spaceflight training. The group later expanded and moved on to become the Manned Spacecraft Center (later Johnson Space Center). From 1959 until 1991, Langley managed the Scout launch vehicle program. The first Scout launch took place in 1960. On January 1, 1991, Langley transferred management of the Scout project to Goddard Space Flight Center.⁵³ Langley was also responsible for NASA's Lunar Orbiter project in the 1960s and the Viking project that orbited and landed spacecraft on Mars in 1976. In the late 1960s, environmental space science became a major research thrust at Langley. The goal of this research was to preserve Earth's ecological balance and prevent undesirable environmental conditions.

⁵³ "Scout Launch Vehicle Program," NASA Facts, NF 173, April 1992.

In the early stages of the Space Shuttle program, Langley conducted thousands of hours of wind tunnel tests on the orbiter. The center was also responsible for optimizing the design of the Shuttle's thermal protection system. Langley investigated technologies necessary for the design and operation of the space station. In 1985, the U.S. Department of the Interior designated five Langley facilities as National Historic Landmarks: the Variable-Density Tunnel (built in 1921), Full-Scale Tunnel (1930), Eight-Foot High-Speed Tunnel (1935), Rendezvous Docking Simulator (1963), and Lunar Landing Research Facility (1965). Langley has also received five Robert J. Collier Trophies in 1929 for the low-drag engine cowling, in 1946 for de-icing research, in 1947 for supersonic flight research, in 1951 for the slotted-throat transonic wind tunnel, and in 1954 for the transonic area rule).

Mission

Langley Research Center is NASA's Center of Excellence for structures and materials research, and the Agency's focal point for wind tunnels and test facilities.⁵⁴ Its primary mission is the research and development of advanced concepts and technology for future aircraft and spacecraft systems, with particular emphasis on environmental effects, performance, safety, range, and economy. Langley also focuses on systems analysis and independent evaluation and assessment of NASA programs before the commitment of major development funding. The center has expertise in airborne systems, aerodynamics, mission and systems analysis, and hypersonic technologies. In the 1990s, Langley and industry participated in the High Speed Research (HSR) program, which examined the advantages of supersonic transport configurations that abandoned

⁵⁴ "Langley Research Center," *1997 Spinoff*, <http://www.sti.nasa.gov/tto/spinoff1998/ard7.htm> (accessed November 13, 2006).

the drooped-nose concept used by the Concorde in order to obtain visibility for takeoff and landing. It also participated in hypersonic air-breathing research with the U.S. Air Force and industry.⁵⁵

Langley is home to several unique wind tunnels. See chapter 3 of this volume for detailed descriptions. Tables 5-53 through 5-57 provide data about Langley.

⁵⁵ Mark A. Chambers, *From Research to Relevance: Significant Achievements in Aeronautical Research at Langley Research Center (1917–2002)*, http://www.nasa.gov/centers/langley/pdf/70787main_FR2R.pdf (accessed November 14, 2006).

Lewis Research Center

Location

Lewis Research Center is located approximately 20 miles (32 kilometers) southwest of Cleveland, Ohio, adjacent to the Cleveland Hopkins International Airport. Plum Brook Station, a satellite of Lewis, is located about 3 miles (5 kilometers) south of Sandusky, Ohio, and 56 miles (90 kilometers) west of Cleveland on 6,400 acres of land.

Director

Donald J. Campbell, January 1994–October 2003

Lawrence J. Ross, July 1990–January 1994

John M. Klineberg, May 1987–July 1, 1990

John M. Klineberg (acting), June 1986–May 1987

Andrew J. Stofan, July 1982–June 1986

John F. McCarthy, October 1978–July 1982

Bernard Lubarsky (acting), August 1977–October 1978

Bruce T. Lundin, November 1969–August 1977

Abe Silverstein, November 1961–October 1969

Eugene J. Manganiello (acting), January 1961–October 1961

Edward R. Sharp, October 1958–December 1960

Deputy Director

Martin Kress, August 1995–July 1999

Fred Povinelli (acting), September 1994–August 1995

J. Stuart Fordyce, April 1991–September 1994

Vacant, July 1990–April 1991

Lawrence J. Ross, December 1987–July 1, 1990

John M. Klineberg, July 1979–May 1987

Bernard Lubarsky, 1974–July 1979

Eugene J. Manganiello, December 1961–1972

History

In 1940, NACA selected Cleveland, Ohio, as the site of the new NACA aircraft engine research laboratory. Groundbreaking took place in 1941, and the NACA Aircraft Research Laboratory was officially dedicated in 1943. As one of the three original NASA research laboratories, during World War II the laboratory concentrated on investigating the problems of aircraft reciprocating, or piston, engines. Lewis engineers also contributed to solving engine-cooling problems on the Super Fortress (B-29) bomber. Before the end of the war, the turbojet engine began to revolutionize the field of aircraft propulsion. The Altitude Wind Tunnel, completed in 1944, contributed to the early testing of U.S.-built jet engines and started the facility on what would become its major focus: jet propulsion studies.

In 1948, the name of the laboratory was changed to NACA Lewis Flight Propulsion Laboratory in memory of George W. Lewis, NACA's director of research from 1924 to 1947. The facility broadened its scope of research to include turbojet engines, ramjets, and rockets, and constructed new facilities, including two supersonic wind tunnels and the Propulsion Systems Laboratory. Lewis became one of the original NASA centers when the Agency was established in 1958.

During the energy crisis of the 1970s, Lewis worked with the U.S. Department of Energy to investigate wind and solar power and to improve the fuel efficiency of automobile engines. Engineers also began work on the advanced turboprop engine. In 1987, a government-contractor team won the Collier Trophy for its work on the advanced turboprop project.

From 1963 to 1998, Lewis was responsible for NASA's launch vehicle program, and the Centaur rocket was one of the most important contributions Lewis made to the space program. The center was responsible for managing the design, building, and launch of the Atlas/Centaur and Titan/Centaur booster vehicles. Lewis also managed the Agena upper stage on several booster vehicles. The center managed the launches of a variety of communications, weather, planetary exploration, and scientific payloads—notably the Surveyor, Viking, Pioneer, and Voyager missions, which studied the Moon, Mars, and outer planets, respectively. Altogether, Lewis managed more than 119 uncrewed launches.

Plum Brook Station near Sandusky, Ohio, is a component facility of Lewis. Its history dates back to 1941, when the War Department acquired about 9,000 acres of land to construct a munitions plant. The plant, then called the Plum Brook Ordnance Works (after the creek running through the site), produced munitions, such as TNT (trinitrotoluene), until the end of World War II. After the war, the land remained idle until 1956, when NACA obtained 500 acres for construction of a nuclear research reactor. The Reactor Facility, which was designed to study the effects of radiation on materials used in spaceflight, was the first of 15 test facilities eventually built by NASA at Plum Brook Station. By 1963, NASA acquired the remaining land at Plum Brook for

these additional facilities. The station covers 6,565 acres owned by NASA and approximately 47 acres in easements.⁵⁶

In the post-Apollo era of the early 1970s, NASA faced budget reductions that caused it to defer many of its longer-term research and development programs. It ceased operations at several research facilities across the country, and in 1973 placed Plum Brook's major test facilities in a standby mode, capable of being reactivated for future use. Smaller facilities were not maintained and some were dismantled. The Reactor Facility was shut down and all of the nuclear fuel was removed and shipped offsite to a U.S. Department of Energy (DOE) facility in Idaho for disposal or reuse. NASA placed the facility in a safe, secure, dry-storage mode and conducted strict oversight and ongoing environmental monitoring around the reactor.⁵⁷

In 1987, NASA, along with several other government agencies and the private sector, expressed a renewed interest in the facilities in standby mode at Plum Brook Station. Because reactivating these facilities would be expensive and would take years to accomplish, NASA decided to perform this work in partnership with its potential users. NASA arranged for users to pay for costs associated with their individual test programs at Plum Brook, including the up-front cost of reactivating the facility from its standby mode. NASA civil servants working at Plum Brook Station would oversee all of the work performed. Some facilities at Plum Brook Station, such as the Reactor Facility, have remained closed. In 1998, a decommissioning plan was formed to

⁵⁶ *Media Guide and Public Affairs Contacts*, June 1989, NASA History Division folder 4527, Historical Reference Section, NASA Headquarters, Washington, DC.

⁵⁷ "The History of NASA's Plum Brook Station," <http://www.grc.nasa.gov/WWW/pbrf/fact-sheets/nasa%20history%20fact.pdf> (accessed November 13, 2006). Also Mark D. Bowles and Robert S. Arrighi, *NASA's Nuclear Frontier; The Plum Brook Reactor Facility*, Monographs in Aerospace History, No. 33 (Washington, DC: NASA SP-4533, 2004), p. 5.

dismantle the Reactor Facility.⁵⁸ Decommissioning began in March 2002, and by October 2006, NASA had removed more than 98 percent of the radioactive inventory that existed at the start of the project. The four remaining active test facilities at Plum Brook Station are the Space Power, Spacecraft Propulsion, Hypersonic Tunnel, and Cryogenic Propellant Tank facilities.⁵⁹

Lewis Research Center was renamed John H. Glenn Research Center at Lewis Field in 1999 in honor of Ohio astronaut and U.S. Senator John H. Glenn, and in commemoration of the legacy of George W. Lewis.⁶⁰

Mission

Lewis Research Center has been designated NASA's lead center for aeropropulsion. It develops and verifies aeropropulsion technologies, and transfers them to U.S. industry. As NASA's designated Center of Excellence for turbomachinery, it develops new and innovative turbomachinery technology to improve the reliability, performance, efficiency, affordability, capacity, and environmental compatibility of future aerospace vehicles.⁶¹ Until 1 October 1998, when the function was transferred to Kennedy Space Center, Lewis was responsible for the overall management of commercial launch services for intermediate and large ELVs for NASA and other government payloads.⁶² Lewis also was responsible for developing the electrical space

⁵⁸ "The History of NASA's Plum Brook Station," <http://www.grc.nasa.gov/WWW/pbrf/factsheets/nasa%20history%20fact.pdf> (accessed November 13, 2006).

⁵⁹ "Plum Brook Reactor Facility Decommissioning, Plum Brook Station, Sandusky, Ohio, Frequently Asked Questions," <http://www.grc.nasa.gov/WWW/pbrf/faq.htm> (accessed November 13, 2006).

⁶⁰ "NASA Glenn History," <http://www.nasa.gov/centers/glenn/about/history/index.html> (accessed April 29, 2007).

⁶¹ "LeRC Fact Sheet," <http://www.lerc.nasa.gov/WWW/PAO/html/factslew.htm> (no longer available online) (accessed June 25, 1997).

⁶² "NASA Glenn Launch Vehicle History (1963–1998)," <http://www.nasa.gov/centers/glen-bout/history/lvpo.html> (accessed November 13, 2006).

power system for the life-support systems and research experiments on the space station. Tables 5-58 through 5-62 provide data about Lewis.

Marshall Space Flight Center

Location

George C. Marshall Space Flight Center is located at the U.S. Army's Redstone Arsenal in Huntsville, Alabama. Marshall also manages the Michoud Assembly Facility, an 832-acre manufacturing site in New Orleans, Louisiana, and until the end of 1994 was in charge of the Slidell Computer Complex in Slidell, Louisiana, a facility that provided computer services to Marshall and to Stennis Space Center. The Slidell Complex was transferred to the City of Slidell, Louisiana, on December 14, 1994.

Director

Arthur G. Stephenson, September 1998–June 2003

Carolyn S. Griner (acting), January 1998–September 1998

J. Wayne Littles, February 1996–January 1998

G. P. 'Porter' Bridwell, January 1994–February 1996

Thomas J. Lee, July 1989–January 1994

James R. Thompson, Jr., September 1986–July 6, 1989

William R. Lucas, June 1974–July 1986

Rocco A. Petrone, January 1973–March 1974

Eberhard F. M. Rees, March 1970–January 1973

Wernher von Braun, July 1960–January 1970

Deputy Director

Carolyn Griner, December 1994–January 2001

Chester ‘Chet’ Vaughn (acting), October 1994–December 1994

Charles Blankenship (acting), April 1994–October 1994

Jay Honeycutt (acting), September–December 1990

J. Wayne Littles, July 1989–December 1994⁶³

Thomas J. ‘Jack’ Lee, December 1980–July 1989

Richard G. Smith, November 1974–August 1978

History

Steps toward establishing Marshall Space Flight Center began early in 1960 when President Dwight Eisenhower submitted a request to Congress to transfer the Army Ballistic Missile Agency’s (ABMA) space missions, including certain facilities and personnel (chiefly the Development Operations Division), to NASA. The transfer became effective March 14, 1960, and NASA set up its “Huntsville Facility” in preparation for formal establishment of the field center later that year. On March 15, President Eisenhower proclaimed that the NASA facility would be called George C. Marshall Space Flight Center, in honor of George C. Marshall, the Army Chief of Staff during World War II, Secretary of State, and Nobel Prize winner for his Marshall Plan.

On July 1, 1960, Marshall officially began operations with the formal transfer of personnel, space projects, and facilities from the U.S. Army. Dr. Wernher von Braun was the center’s first director. The center’s primary mission responsibility was to develop the Saturn family of launch

⁶³ Littles attended Harvard Business School program in the fall of 1990 for three months. He also was temporarily assigned to NASA Headquarters from April 1994 to December 1994.

vehicles used in the Apollo lunar-landing program, the Skylab experimental space station program, and the U.S.-Soviet Apollo-Soyuz Test Project.

In 1961, Marshall's Mercury-Redstone launch vehicle boosted America's first astronaut, Alan B. Shepard, on a suborbital flight. Other Marshall projects included Pegasus in 1965, the Lunar Roving Vehicle in 1971 for transporting astronauts on the lunar surface, the Skylab and Apollo Telescope Mount in 1973 (the first U.S.-crewed orbiting space station), the three High Energy Astronomy Observatories to study stars and star-like objects, and the Hubble Space Telescope, before its transfer to Goddard Space Flight Center. Marshall led NASA's Spacelab missions and was also responsible for the definition and preliminary design of pressurized common modules, environmental-control, life-support, and propulsive systems, and other elements of the space station. In 1998, NASA launched the first U.S. space station element—the Unity node, built by the Boeing Company at Marshall.

Marshall was responsible for the Space Shuttle's solid-fueled rocket booster, main engine, and external tank.⁶⁴ The center also led the redesign of the solid rocket motor for the Return to Flight mission following the *Challenger* accident. In 1999, NASA and Boeing entered into a \$173 million cooperative agreement to develop a new experimental space plane called the X-37, which was to be ferried into orbit to test new technologies for RLVs.⁶⁵

⁶⁴ "Marshall Space Flight Center (MSFC)," <http://history.nasa.gov/centerhistories/marshall.htm> (accessed November 13, 2006). Also "MSFC Historical Synopsis," <http://history.msfc.nasa.gov/synopsis.html> (accessed November 13, 2006).

⁶⁵ "MSFC Historical Synopsis," <http://history.msfc.nasa.gov/synopsis.html> (accessed November 13, 2006).

Marshall manages the Michoud Assembly Facility in New Orleans, and until 1994 was in charge of the Slidell Computer Complex at Slidell, Louisiana. Michoud was established in during World War II to manufacture cargo planes and landing craft. It was used during the Korean conflict to produce engines for Sherman and Patton tanks. NASA took over the facility in 1961 through a congressionally approved property transfer from DOD for the design and assembly of large space vehicles. Michoud was the site of construction of the Saturn S1B and S1C boosters. In 1973, NASA awarded Martin Marietta Aerospace a contract to design, develop, and manufacture the external propellant tanks for the Space Shuttle system. Lockheed Martin is currently responsible for manufacturing these components. The Michoud Assembly Facility features one of the world's largest manufacturing plants and a port with deepwater access for transporting large space structures. Michoud Operations also plays a leading role in developing experimental space vehicles and related projects.⁶⁶

Marshall acquired the 14-acre Slidell site in May 1962, and a high-speed computer facility began operating in August 1962. Slidell supported the Mississippi Test Facility (later Stennis Space Center), where the first two stages of the Saturn V rockets were static-fired. Over the years, the complex supported NASA's space science and Skylab and Earth resources missions, Shuttle launch processing, and external tank processing. In 1994, NASA decided to move the External Tank Automated Data Processing support from the complex at Slidell, Louisiana, to Marshall, resulting in the closure of the Slidell facility.⁶⁷

⁶⁶ "History of Michoud," Lockheed Martin, <http://www.lockheedmartin.com/wms/findPage.do?dsp=fec&ci=15374&rsbci=15260&fti=0&ti=0&sc=400> (accessed December 5, 2006). Also "Center Director Welcome," <http://employeeorientation.nasa.gov/michoud/welcome.htm> (accessed December 5, 2006).

⁶⁷ "Management Announcement; Creation of the Slidell Computer Complex (SCC) Closure Team" Marshall Space Flight Center, May 11, 1994. Also "Chronological History" prepared by Marshall Space Flight Center Historian

Marshall manages the Santa Susanna Field Laboratory (SSFL) in Ventura County, California. Rocket engines, including early Saturn engines, Shuttle engines, and the linear aerospike engine for the planned X-33, were tested at the facility, which was operated by the Rocketdyne Division. Of the SSFL's 2,700 acres, NASA-owned facilities and land comprised 452 acres. The initial parent company, North American Aviation, which became Boeing North American, Inc., established the Rocketdyne Division in 1955 to operate the SSFL. North American Aviation had owned much of the land at the SSFL since 1954 and operated most of the facilities since 1947. In 1955, the U.S. Air Force (USAF) acquired title to the Liquid Oxygen Plant in Area 1 and all of Area II from Rocketdyne. NASA negotiated a facilities contract in August 1962 with the Air Force for joint usage of Area II. NASA acquired this property in November 1973 to support the Space Shuttle Main Engine project. Until 1961, environmentally hazardous materials were used to flush engines and test stands after test firings, resulting in significant environmental contamination. At least into the late 1990s, in compliance with federal law, NASA worked with Rocketdyne to clean up the hazardous waste site.⁶⁸

Mission

Marshall Space Flight Center is NASA's lead center for space transportation systems development and microgravity research. The center is the designated Center of Excellence for space propulsion. Major program areas include RLV technology, advanced space transportation, microgravity research, Space Shuttle propulsion systems, space station support and utilization,

Mike Wright, December 2, 1994, NASA History Division folder 8720, Historical Reference Section, NASA Headquarters, Washington, DC.

⁶⁸ "Executive Summary: Cost Sharing for Santa Susana Field Laboratory Cleanup Activities," IG-98-024, http://oig.nasa.gov/audits/reports/FY98/executive_summaries/ig-98-024es.htm (accessed December 11, 2006). Also *Audit Report: Cost Sharing for Santa Susana Field Laboratory Cleanup Activities*, August 18, 1998, p. 3, <http://oig.nasa.gov/audits/reports/FY98/pdfs/ig-98-024.pdf> (accessed December 11, 2006).

the Advanced X-ray Astrophysics Facility (AXAF), scientific payloads and research, and Spacelab missions.⁶⁹ Tables 5-63 through 5-67 provide data about Marshall.

⁶⁹ George C. Marshall Space Flight Center, *Implementation Plan*, November 1996, p. iv.

Stennis Space Center

Location

Stennis Space Center is located in Bay St. Louis, Mississippi, approximately 48 miles (77 kilometers) west of Biloxi and 45 miles (72 kilometers) east of New Orleans.

Director

Roy S. Estess, January 1989–August 2002

Jerry I. Hlass, September 1, 1976–January 23, 1989⁷⁰

Jackson M. Balch, June 1974–August 1976

Deputy Director

Mark Craig, January 1995–January 2001

Gerald Smith, June 1989–January 1995

Roy Estess, August 1980–January 23, 1989

Harry Auter, 1963–February 1979

History

Stennis Space Center began as Mississippi Test Operations in October 1961 when the federal government selected the area in Hancock County, Mississippi, as the site of a static test facility for launch vehicles to be used in the Apollo lunar landing program. The site was originally designated as the location for a large booster test facility under the direction of NASA's Marshall Space Flight Center. It was chosen because of its deepwater access via the Pearl River and the

⁷⁰ Before National Space Technology Laboratories was renamed Stennis Space Center in 1988, the director and deputy director held the titles of "manager" and "deputy manager," respectively. Therefore, Hlass was "manager" until May 20, 1988, when he became "director."

Intercoastal Waterway, which was essential for transporting large rocket stages, components, and loads of propellants. The 13,500-acre test facility also had a sound buffer of almost 125,000 acres. In 1965, the center's name was changed to the Mississippi Test Facility.⁷¹ During its early years, the center flight-certified all first and second stages of the Saturn V rocket for the Apollo program. When the Space Shuttle program got under way, the center flight-certified all of the engines used to boost the Shuttle into low-Earth orbit.

In 1974, the facility received independent NASA field center status, becoming the National Space Technology Laboratories. In May 1988, it was renamed the John C. Stennis Space Center in honor of U.S. Senator John C. Stennis, a staunch supporter of the space program.

The center has evolved into a multidisciplinary facility used by NASA and 22 other resident agencies engaged in space and environmental programs and national defense. The U.S. Navy established various organizations at Stennis Space Center in 1976, and is the center's largest resident agency. Navy organizations include the headquarters of the Commander, the Naval Meteorology and Oceanography Command, and its largest subordinate activity, the Naval Oceanographic Office. Other agencies at Stennis include the National Data Buoy Center (part of the National Weather Service), the National Marine Fisheries Service (a component of the National Oceanic and Atmospheric Administration [NOAA]), the U.S. Geological Survey, and the Environmental Protection Agency Environmental Chemistry Laboratory.⁷²

⁷¹ "Stennis Space Center (SSC)," <http://history.nasa.gov/centerhistories/stennis.htm> (accessed November 13, 2006).

⁷² "John C. Stennis Space Center," NASA booklet, no date or publication number.

Mission

The primary mission of Stennis Space Center is to provide the capacity to test rocket propulsion engines, systems, and vehicles. Its major test program focuses on developing and flight-certifying the Space Shuttle's main engine and testing large rocket propulsion systems for future space vehicles. In 1997, Stennis was designated NASA's lead center for implementing commercial remote sensing activities.⁷³ It is NASA's Center of Excellence for rocket propulsion testing.⁷⁴ Tables 5-68 through 5-72 provide data about Stennis.

⁷³ "Stennis Chronology," <http://www.nasa.gov/centers/stennis/about/history/chronology/chronology.html> (accessed November 15, 2006).

⁷⁴ "Office of the Chief Technologist, NASA Centers of Excellence," <http://www.hq.nasa.gov/office/codeaf/codeaf/excellence.htm> (accessed May 1, 2007).

CHAPTER 6: NASA PERSONNEL

Introduction

The decade from 1989 through 1998 began with a period of slight growth in the size of NASA's workforce followed by a decrease in its size. The workforce grew after the *Challenger* accident when concern surfaced about inadequate staffing in core engineering disciplines and the need for an infusion of young engineers and scientists who were just graduating from universities. Fiscal year (FY) 1989 was the largest single hiring year since the 1960s, and the NASA workforce peaked in 1992.¹

When William Clinton became President in 1993, he initiated steps to reduce the size of the entire federal government workforce. An Executive Order in February 1993 directed that the total federal workforce be reduced by 4 percent (100,000 employees) by the end of FY 1995.² In September 1993, the National Performance Review, led by Vice President Albert Gore, recommended a reduction of 252,000 federal employees by 1999.³ Subsequently, Congress passed a Workforce Restructuring Act in March 1994 legislating an overall reduction of 272,900 by 1999.⁴ In response to this mandate, NASA began cutting its workforce during FY 1993. NASA's workforce continued to shrink during the balance of the 1990s (see figure 6-1).⁵

¹ "Brief History of the NASA Workforce," <http://nasapeople.nasa.gov/workforce/data/page16.htm> (accessed December 5, 2006).

² "Reduction of 100,000 Federal Positions," Executive Order 12839, February 10, 1993, <http://www.archives.gov/federal-register/executive-orders/pdf/12839.pdf> (accessed April 24, 2007).

³ "Albert Gore, *From Red Tape to Results: Creating a Government that Works Better and Costs Less; Report of the National Performance Review*, September 7, 1993, <http://govinfo.library.unt.edu/npr/library/nprprt/annrpt/redtape93/23ba.html> (accessed April 24, 2007).

⁴ U.S. Congress, *Federal Workforce Restructuring Act*, Public Law 103-226, 103rd Cong., 2nd sess., March 30, 1994.

⁵ "Brief History of the NASA Workforce," <http://nasapeople.nasa.gov/workforce/data/page16.htm> (accessed December 5, 2006).

The Agency offered buyouts to its employees in the mid-1990s. Also known as a Voluntary Separation Incentive, this buyout authority allowed NASA to pay up to \$25,000 as a bonus to employees who resigned or retired during set periods. The majority of NASA’s buyout losses occurred in 1994 and 1995, when two buyouts spurred more than 2,500 voluntary separations.⁶ Other buyouts later in the 1990s resulted in more than 2,000 additional separations.

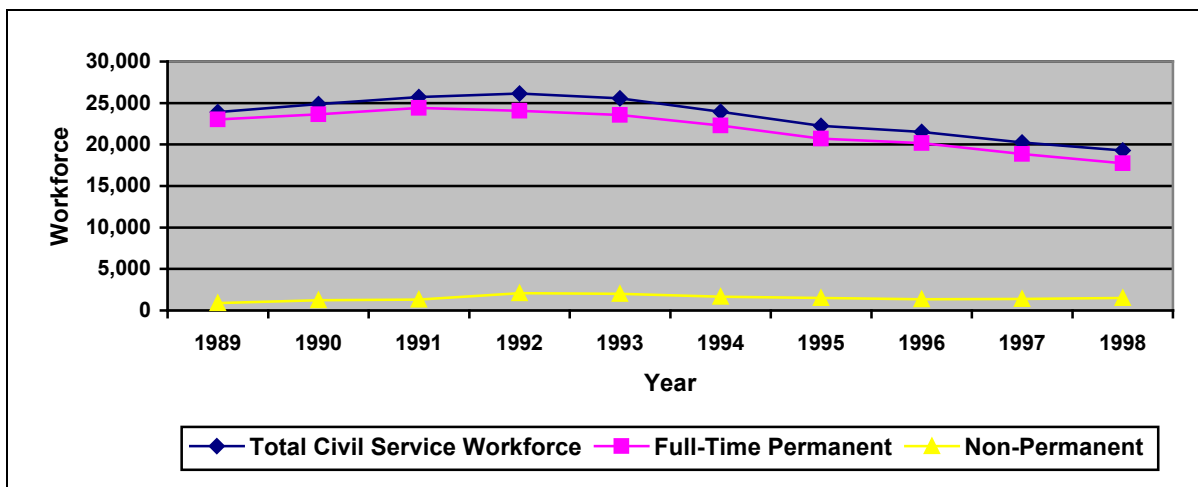

Figure 6-1. Total civil service, permanent, and non-permanent workforce (at end of fiscal year).

During the 1990s, the composition of NASA’s workforce shifted toward a more professional makeup. The proportion of scientists and engineers and professional administrative personnel increased, while the proportion of staff in the other occupational codes decreased (see figure 6-2). The educational level of the workforce also rose. A slightly greater proportion of NASA staff had advanced college degrees, and fewer had only a bachelor’s degree; still fewer had only a high school education, although the percentage still reached the 20 percent level at the end of the decade (see figure 6-3).

⁶ “Workforce Glossary,” <http://nasapeople.jsc.nasa.gov/workforce/data/page17.htm> (accessed December 5, 2006).

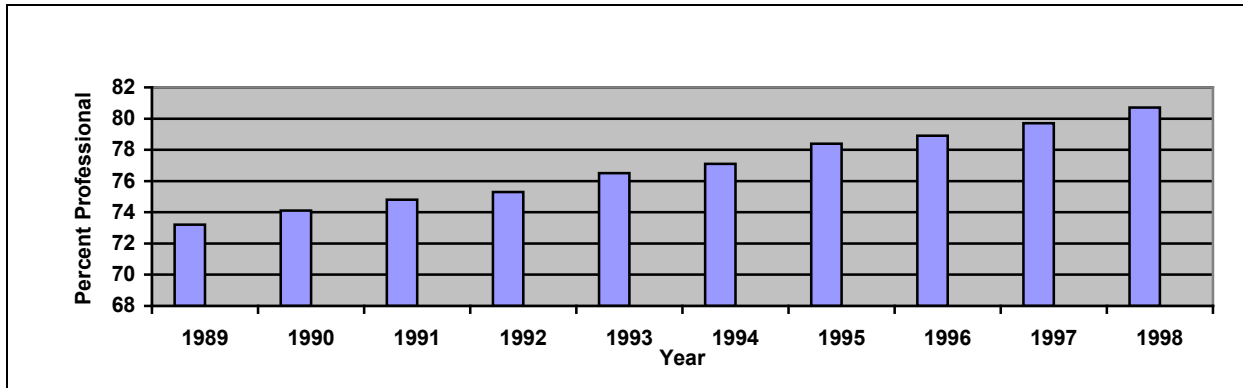

Figure 6-2. Professional occupational groups for full-time permanent employees (occupational codes 200, 600, 700, and 900).

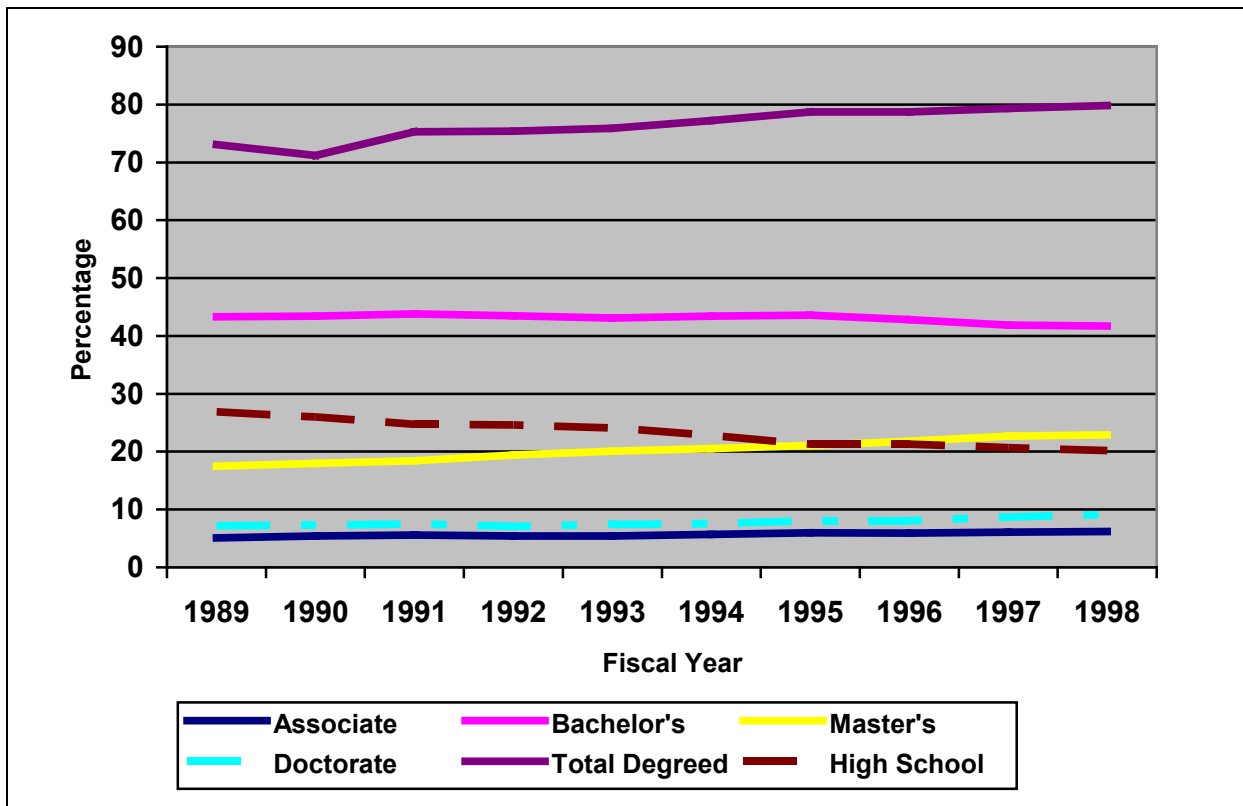

Figure 6-3. Educational level of full-time permanent employees.

In most years during the decade, salaries increased at a slight but steady pace (see figure 6-4). For white-collar employees, the rate of increase varied between 3.6 percent and 6.5 percent, with most years' increases in the 4.5 percent range. Increases for blue-collar employees ranged from 2.2 percent to 5.3 percent, and fell primarily at around 3.5 percent. Across the entire Agency, increases averaged around 5 percent.

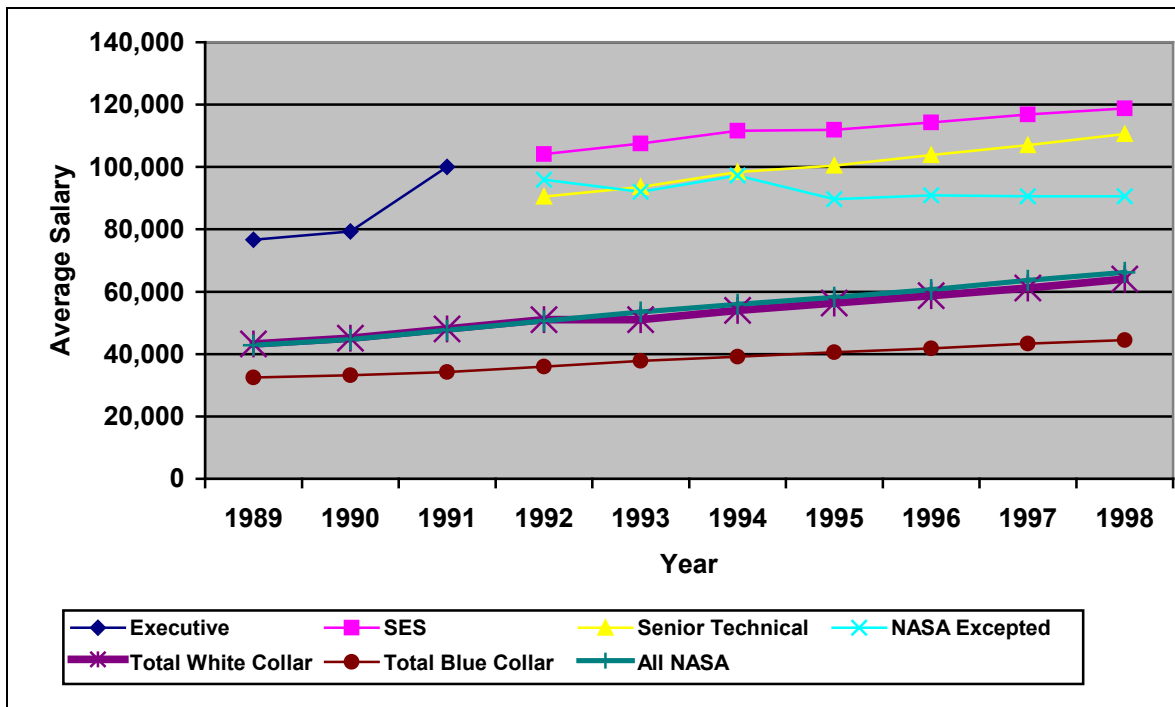

Figure 6-4. Average salary trends of permanent employees by pay plan.

NASA's workforce became more diverse during the decade and the percentage of minorities in the NASA workforce grew from 15 percent in 1989 to 20.7 percent in 1998 (see figure 6-5). Although the number of minority employees grew by only 232, this small increase occurred while the NASA workforce as a whole was shrinking. However, minorities were still represented disproportionately in most employment categories. Minorities were overrepresented in grades

GS-1 to GS-6, holding between 27 percent and 41 percent of positions—considerably more than their percentage of the total NASA population. At the GS-7 to GS-12 level, they were also overrepresented, holding 18 percent to 27 percent of these positions. At the GS-13 to GS-15 level, minorities were underrepresented during the first part of the decade, holding only 9.4 percent of these positions. By the end of the decade, however, the proportion of minorities in GS-13–15 positions had grown to 17 percent and was approaching their percentage of the total NASA population. In the Senior Executive Service (SES), Senior Technical, and NASA Excepted positions, minorities were grossly underrepresented for most of the decade, holding only 4.2 percent of these positions in 1989. By 1998, they had moved into 13.7 percent of these senior positions, while overall they accounted for 20.7 percent of the NASA workforce. At the Wage System level, minorities were overrepresented, with their relative position worsening during the decade. In 1989, minorities held 20.5 percent of Wage System positions. By 1998, this had risen to 33.7 percent.

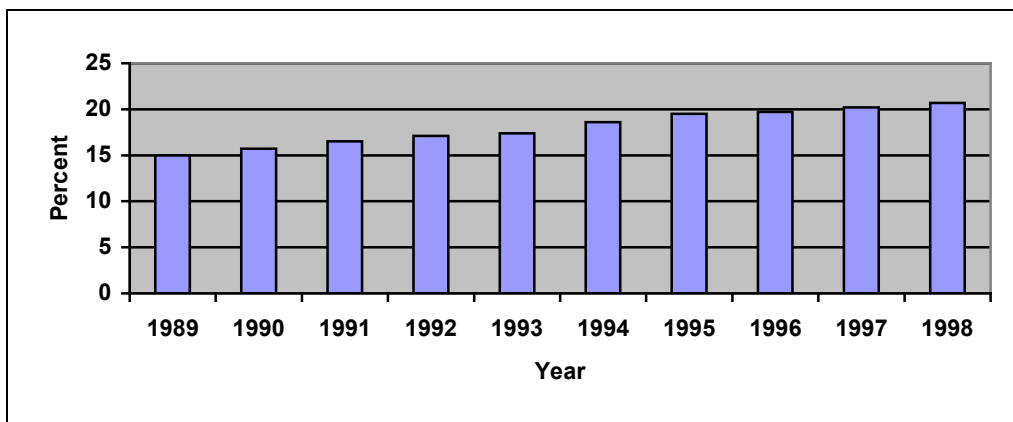

Figure 6-5. Minority full-time permanent employees as a percentage of NASA permanent employees.

An upward trend in the percentage of female employees also occurred. The percentage of females in the NASA workforce increased from 28.3 percent in 1989 to 31.6 percent in 1998 (see figure 6-6). Growth occurred in the professional positions and in the upper grades, although women were still underrepresented in these areas. The percentage of women in GS-13 to GS-15 grew from 4.5 percent in 1989 to 13.8 percent in 1998. In 1989, women moved from holding largely clerical positions to holding a greater proportion of professional positions (12.6 percent of scientist and engineer jobs were held by women). This grew to 17 percent by 1998. The percentage of professional administrative jobs grew from 47.1 to 59.9. Women continued to be underrepresented in the senior executive positions, holding only 4 percent of these positions in 1989 and reaching a high of 15.6 percent in 1998—still considerably less than their proportion in the total NASA population. Women continued to hold almost all clerical jobs; more than 95 percent of these positions were held by women during this decade.

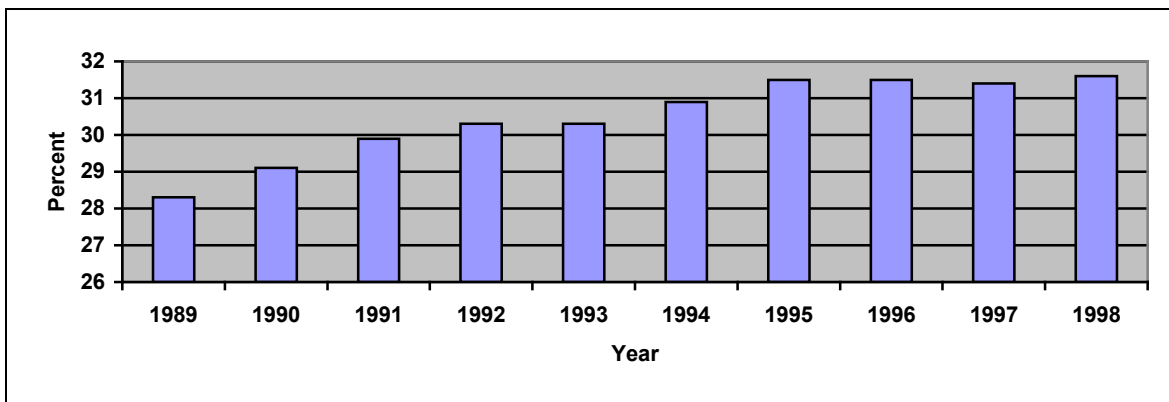

Figure 6-6. Female full-time permanent employees as a percentage of NASA permanent employees.

The NASA workforce remained a largely middle-aged workforce. The percentage of employees under the age of 29 decreased the most dramatically, and the average age of the workforce remained in the 40s (see figure 6-7).

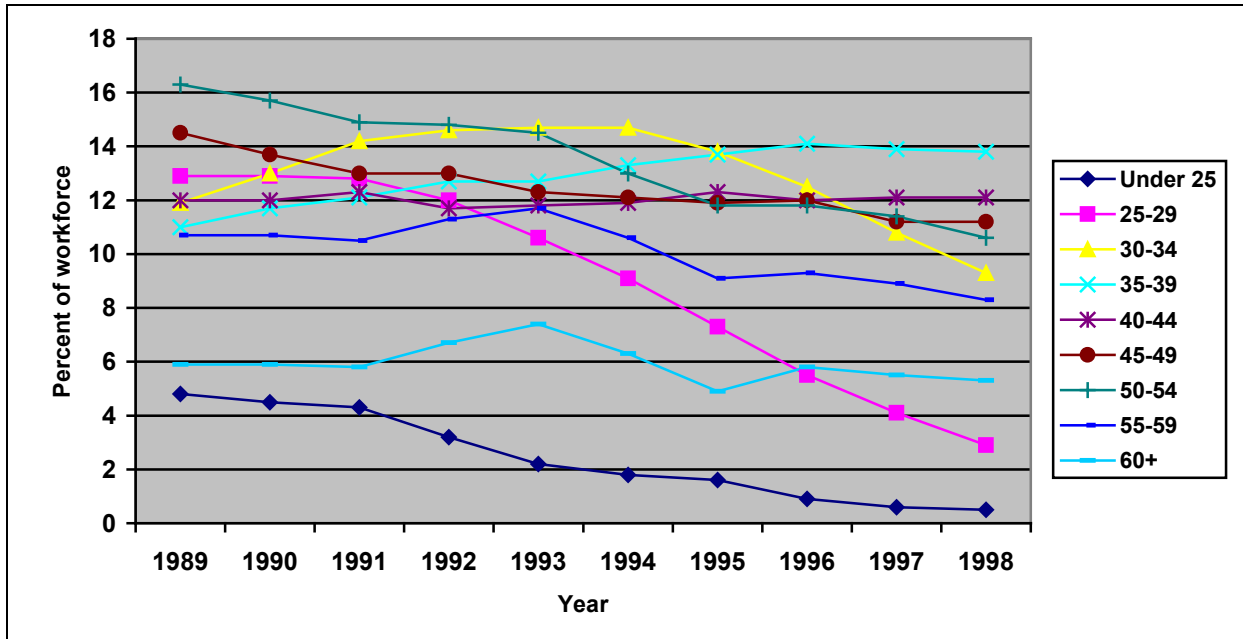

Figure 6-7. Age profile of NASA full-time permanent employees.

Definition of Terms

Occupational Code Groups

NASA organizes its jobs into the following principal job groups and occupational codes:

- Scientists and Engineers (SEs) (Codes 200, 700, and 900):** Professional scientific and engineering positions engaged in aerospace research, development, operations, and related activities. Also included are life science professionals, such as physicians, nurses, psychologists, and biologists. Nearly all NASA SEs are in the Aerospace Technologist (AST) (Code 700) job categories.

This category is divided into three subcategories:

- Support Engineering and Related Positions (Code 200): includes professional physical science, engineering, and mathematician positions in work situations not identified with aerospace technology.

- Aerospace Technologist (Code 700): includes professional scientific and engineering positions requiring AST qualifications; includes professional positions engaged in aerospace research, development, operations, and related work, including the development and operation of specialized facilities and support equipment.

- Life Science Support Positions (Code 900): includes life science professional positions not requiring AST qualifications; includes medical officers and other positions performing professional work in psychology, the biological sciences, and professions supporting the science of medicine, such as nursing and medical technology.

- **Professional Administrative (Prof'l Admin) (Code 600):** Specialists in such functions as financial management, contracting, human resources, law, public affairs, and the like for which a college degree or equivalent specialized training and experience is required.

- **Clerical (Code 500):** Secretarial, clerical, and administrative technician positions, including specialized clerical and technical positions in administrative functions such as supply, purchasing, accounting, personnel, etc.

- **GS Technician or Technical Support (GS Tech) (Code 100):** White-collar engineering and laboratory technicians and specialists in technical support functions such as drafting,

photography, illustrating, quality assurance, etc. These technicians are paid according to the General Schedule (GS).

- **Wage System (Wage):** Skilled trade and mechanic positions paid at prevailing local hourly rates according to provisions of the Federal Wage System. (Formerly a major component of the civil service workforce, by this decade only a relatively few wage-grade employees remained at NASA.)

Professional staff includes all SE and Professional Administrative personnel. Support staff includes all Clerical, GS Technicians, and Wage System personnel.⁷

Pay Grade

Civil Service positions are classified according to a variety of pay plans and grades based on the complexity, difficulty, and level of responsibility of the position. The most common pay plan is the General Schedule (GS), which includes 15 pay grades from GS-1 at the low end to GS-15 at the high end. Other common NASA pay plans include the Senior Executive Schedule (SES) and various Federal Wage System pay plans.

Note on Workforce Data

The information for the tables in this chapter (tables 6-1 to 6-33) for FY 1989 through FY 1991 comes from *Civil Service Work Force: A Report to Management*, which is published each year by NASA's Management Systems Division in the Office of Human Resources and Education. NASA changed to a different method of publishing personnel data in FY 1992, when it began populating a data cube with workforce data. This allowed NASA to combine the data in a

⁷ "NASA Workforce," <http://nasapeople.nasa.gov/workforce/data/page17.htm> (accessed November 29, 2006).

number of ways and obtain more extensive information about its workforce. In the following tables, data for these years come from this data cube. Graphs are all derived from the tabular data.

CHAPTER 7: FINANCES AND PROCUREMENT

Introduction

This chapter provides an overview of NASA's budgetary and procurement activities, primarily in tabular form. The first part of the chapter addresses NASA's finances and the second part focuses on procurement. Data in the finances section were obtained largely from NASA's annual budget estimates. Data in the procurement section were drawn from NASA's annual procurement reports.

Finances

The tables in this chapter relating to NASA's budget provide top-level budget data for fiscal years (FY) 1989–1998. More detailed budget data on NASA's programs are provided in the chapters relating to each of the programs.¹ A description of NASA's budget process can be found in chapter 1 of volume VII of the *NASA Historical Data Book*.

Budget-related terms used in this chapter are defined below.²

- An *appropriation* provides legal authority for federal agencies to incur obligations and to make payments out of the Treasury for specified purposes. During this decade, NASA's appropriations were part of appropriation bills for the departments of Veterans Affairs and Housing and Urban Development, and independent agencies. "Appropriation" is also the

¹ Judy Rumerman, chapters 2–4 in *NASA Historical Data Book, 1989–1998*, and chapters 2–4 in *NASA Historical Data Book, 1989–1998, Volume VIII*.

² Office of Management and Budget, "Glossary," <http://www.whitehouse.gov/omb/budget/fy2006/glossary.html> (accessed January 11, 2007). Also *The Budget for Fiscal Year 1997, Historical Tables*, p. 3, <http://www.gpoaccess.gov/usbudget/fy97/pdf/hist.pdf> (accessed January 11, 2007) and *NASA Financial Management Manual*, August 2001, <http://www.hq.nasa.gov/fmm/9000/9020.pdf> (accessed May 10, 2007).

term used to describe each budget category into which Congress places a specific level of funds. By law, NASA must receive congressional approval to reallocate funds among appropriation categories.

- *Budget authority* is the authority provided by law to incur financial obligations that will result in outlays of up to a specific amount. The authorization may be limited to a particular number of fiscal years and is usually for a particular purpose.
- *Disbursements* are outlays of public moneys and the rendering of accounts in accordance with the laws and regulations governing the distribution of public moneys.
- The federal government's fiscal year (FY) is its accounting period. It begins on October 1 and ends on September 30. The FY designation is the calendar year in which the FY ends. For example, FY 1996 began on October 1, 1995, and ended on September 30, 1996.
- *Obligations* are binding agreements resulting in outlays, immediately or in the future.
- *Outlays* are payments to liquidate obligations, largely measured on a cash basis. Total federal outlays are a net figure, consisting of gross payments minus offsetting receipts in a given fiscal year. They are the primary measure of government spending. Outlays equal the amount of checks issued or other payments, net of refunds and reimbursements.
- *A supplemental appropriation* is an appropriation enacted after the regular annual appropriation act has been enacted. It provides additional budget authority for programs or activities (including new programs authorized after the date of the original appropriations act) when the need for funds is too urgent to be postponed.

Through FY 1994, NASA had four primary appropriation categories. Research and Development (R&D) funded most of NASA's flight projects and basic research activities. The Space Flight,

Control, and Data Communications (SFC&DC) appropriation funded Shuttle-related and most tracking and data-acquisition activities. The space station was funded out of both R&D and SFC&DC appropriations, depending on the specific activity. Research and Program Management (R&PM) financed civil servant salaries regardless of the project or office in which an individual worked, related expenses such as benefits and training, and employee travel. The Construction of Facilities (CofF) appropriation funded the design, construction, and modernization of facilities; purchase of land; and design of facilities planned for future authorization.

In FY 1995, NASA established three new appropriation categories. The Science, Aeronautics and Technology (SAT) appropriation provided funding for NASA's R&D activities, including acquiring knowledge about Earth, its space environment, and the universe, and investigating new aeronautics and advanced space transportation technologies to support the development and application of important technologies to ensure the country's economic, scientific, and technical competitiveness.³ The Human Space Flight (HSF) appropriation provided funding for NASA's human spaceflight activities, such as on-orbit infrastructures (the space station and Spacelab), transportation capabilities (the Space Shuttle program, including operations, program support, and performance and safety upgrades), and the Russian Cooperation program, which included the flight activities associated with the cooperative research flights to the Russian Mir space station.⁴ The Mission Support (MS) appropriation provided funding for agencywide activities to support NASA's civil service workforce, provide the space tracking and communications capabilities required by all missions, conduct safety and quality assurance activities, and carry

³ "General Statement," Science, Aeronautics and Technology Fiscal Year 1998 Estimates.

⁴ "General Statement," Human Space Flight, Fiscal Year 1996 Estimates.

out activities to preserve NASA's core infrastructure.⁵ In many instances, activities funded from the former R&D appropriation moved directly to the SAT appropriation, activities funded by the SFC&DC appropriation moved to HSF, and activities funded by the Coff and R&PM appropriations moved to MS. Since there was so much reshuffling of program funds, it is difficult to compare former appropriations with new ones. Thus, in the following tables and graphs, post-FY 1995 appropriations are treated as new funding categories.

In addition, a separate appropriation funded NASA's Office of Inspector General (OIG) for FY 1990–FY 1998. NASA's budget also included funding for an educational trust fund as a separate appropriation in FY 1989, and funding for National Aeronautical Facilities as a separate appropriation in FY 1995.

NASA's funding was a very small part of the total federal budget. As shown in table 7-1, the Agency's outlays never rose above 1 percent of the total federal budget during this decade. Taking into account the rate of inflation, NASA's funding grew during the first four years of the decade but then dropped each of the following years of the decade as the President and Congress worked to reduce the federal deficit. At the end of the decade, NASA's budget was below the FY 1989 level when inflation is factored in. Figure 7-1 shows the relative amounts allocated to each appropriation and the level of total funding in real-year dollars. Table 7-2 and figure 7-2 show how funding for each appropriation category changed from one year to the next.

⁵ "General Statement," Mission Support Fiscal Year 1998 Estimates.

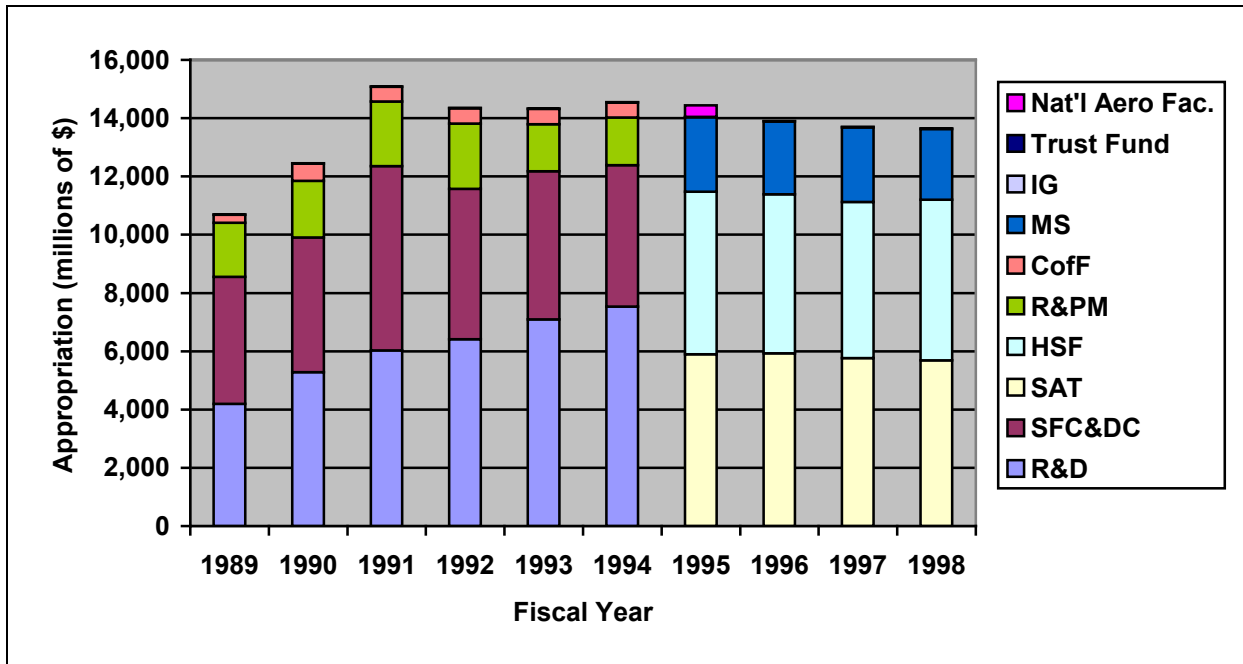

Figure 7-1. Total NASA appropriations: FY 1989–FY 1998.

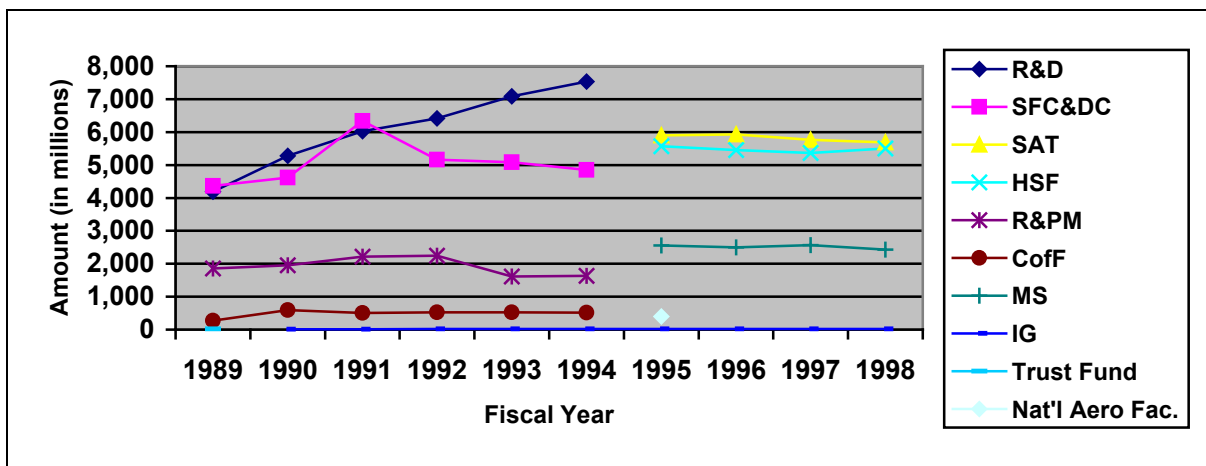

Figure 7-2. Individual NASA appropriations: FY 1989–FY 1998.

In simple terms, the budget cycle consists of an initial request from NASA for funding submitted each year to the Office of Management and Budget (OMB). The OMB submits this request to Congress as part of the President’s annual budget request. Congressional committees consider

the request and prepare both an authorization bill and an appropriation bill. The authorization bill authorizes NASA to spend up to a certain amount for a specific purpose. An appropriation bill specifies exact amounts that the Treasury may legally pay out to meet NASA's obligations. An authorization bill is not required, and in the decade from 1989 to 1998, only three authorization bills were passed by Congress and signed by the President.

During this decade, the amount Congress appropriated was usually less than the amount of funds requested. Table 7-3 shows NASA's initial funding request, authorized amounts (if any), appropriated amounts, and adjustments to the initial appropriation for each fiscal year and appropriation category. NASA's funds may be used for only a particular number of years (usually one or two). If they are not used during this period, they become "lapsed" and are no longer available. During this decade, NASA was occasionally criticized for having excessive lapsed funds, indicating to some that the Agency exercised poor planning and inefficient use of its money.

Table 7-4 compares the amount appropriated with the amount requested for each fiscal year and appropriation category. Table 7-5 shows the total annual requests, authorizations, appropriations, obligations, and expenditures. Tables 7-6 through 7-12 show funding for each appropriation category broken down by NASA center. Table 7-13 shows funding for major NASA programs within each appropriation.

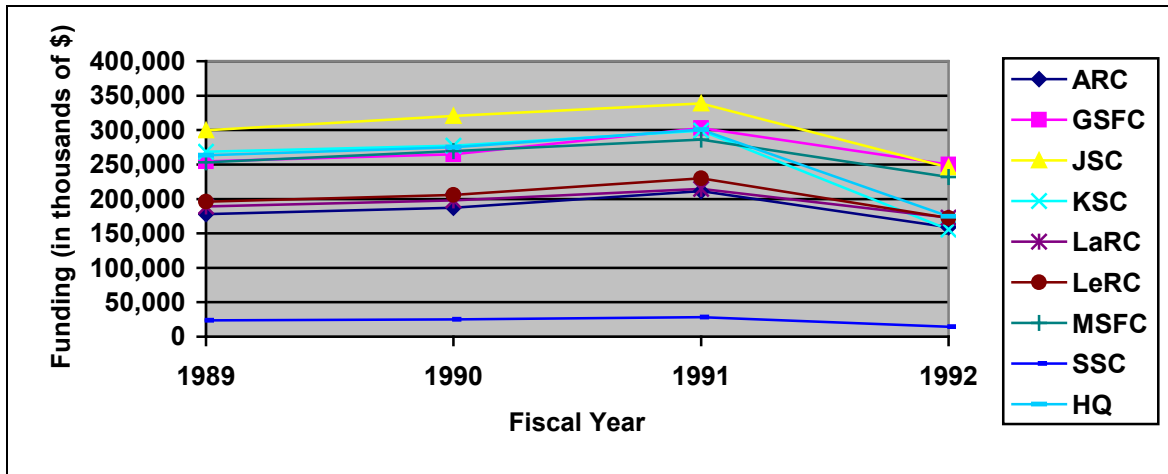

Figure 7-3. Research and Program Management funding by NASA installation.

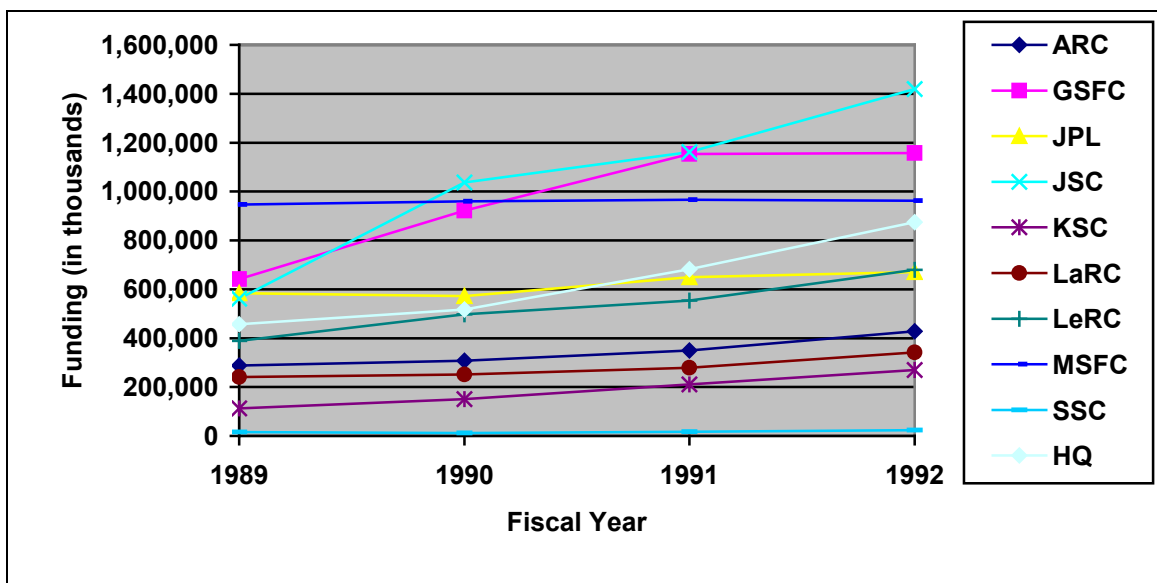

Figure 7-4. Research and Development funding by NASA installation.

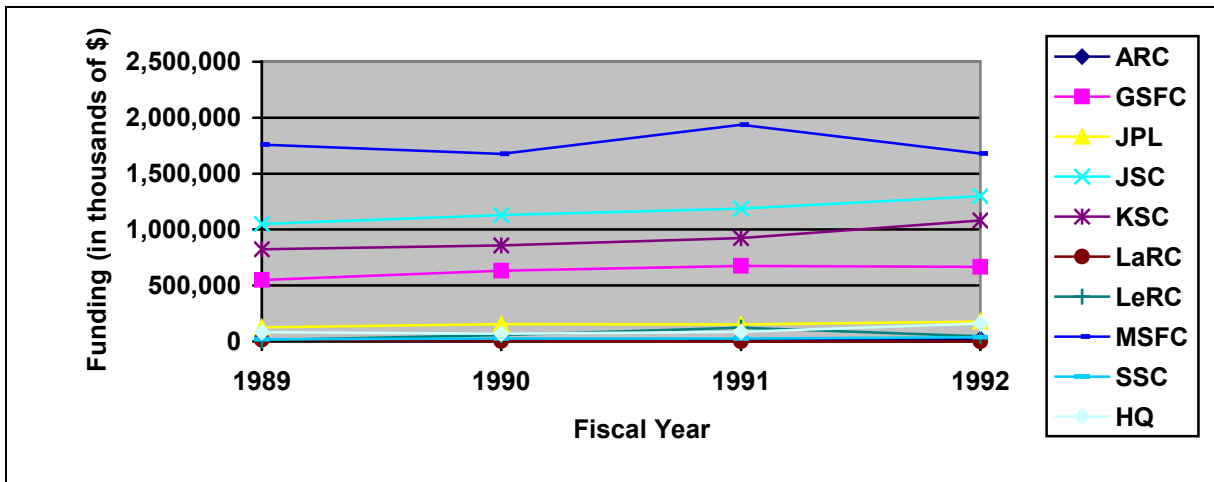

Figure 7-5. Space Flight, Control, and Data Communications funding by NASA installation.

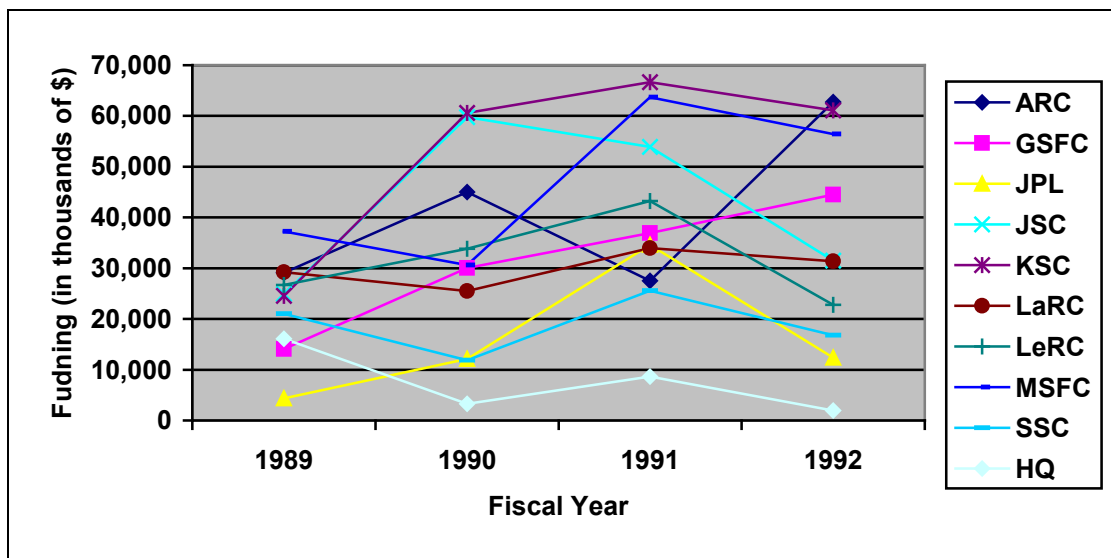

Figure 7-6. Construction of Facilities funding by NASA installation.

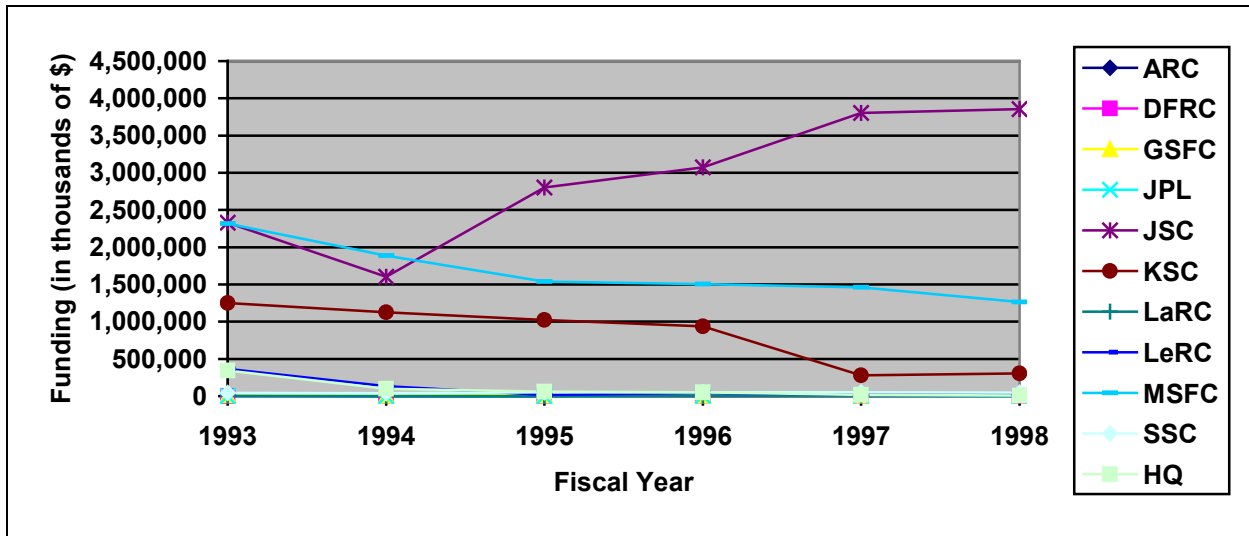

Figure 7-7. Human Spaceflight funding by NASA installation.

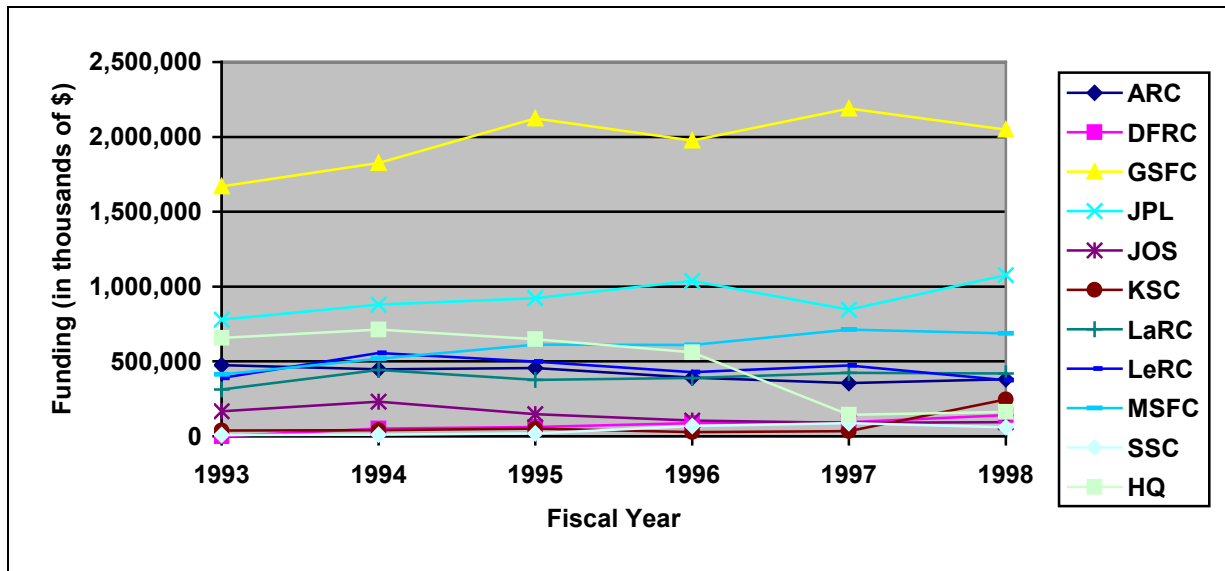

Figure 7-8. Science, Aeronautics, and Technology funding by NASA installation.

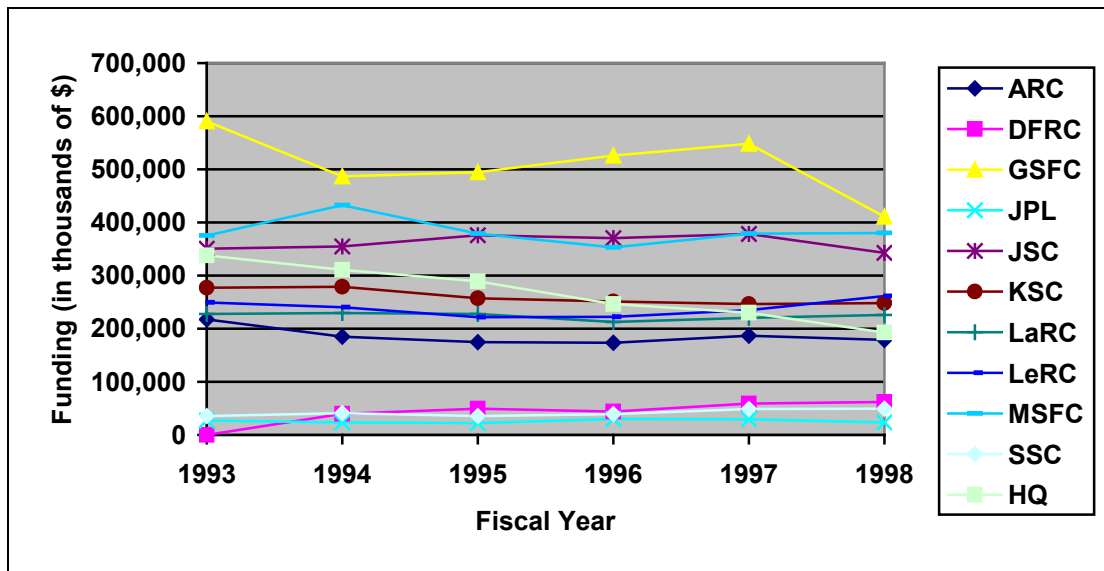

Figure 7-9. Mission Support funding by NASA installation.

Procurement

From 1989 to 1998, more than 85 percent of NASA’s obligations were devoted to procurement actions. This percentage, however, decreased during the decade, falling from 90 percent in FY 1990 to a low of 87.1 percent in FY 1998 (figure 7-10). The dollar value of NASA’s procurements also fell slightly toward the end of the decade as the Agency’s budget decreased, although it was higher at the end of decade than at the beginning (see figure 7-11). The lowest total value of awards was \$10,876.4 million in FY 1990; the highest value was \$13,478.2 million in FY 1992. The total number of procurement actions peaked in FY 1990 at 115,300 and fell to a low of 67,300 in FY 1998 (see figure 7-12).

NASA awarded procurements to large and small businesses, nonprofit and educational institutions, the Jet Propulsion Laboratory (JPL), other government agencies, and organizations outside the United States. The great majority of procurements (83 percent) were awarded to

business firms. Although the dollar value of awards to large business firms was vastly greater than those awarded to small business firms, the number of awards to small business firms was much larger than the number awarded to large firms (see figures 7-13 and 7-14, and tables 7-15 to 7-20).

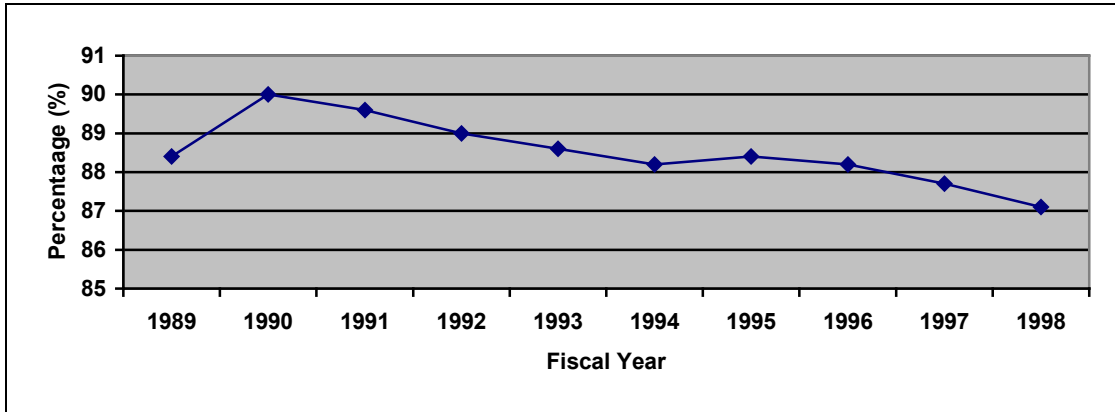

Figure 7-10. Percentage of NASA obligations devoted to procurement actions.

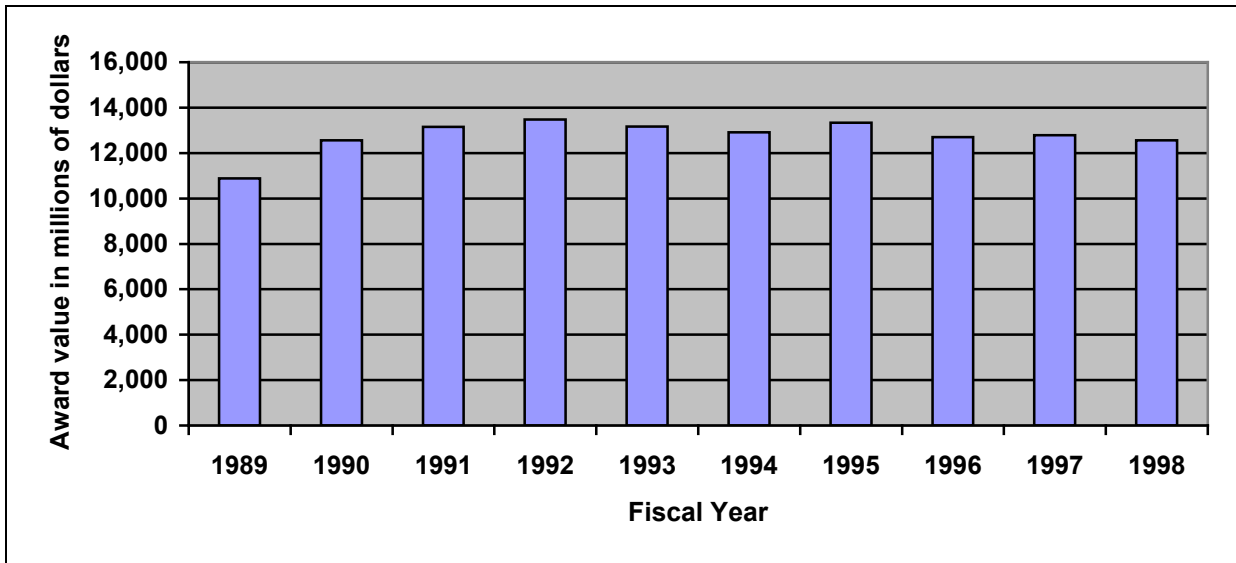

Figure 7-11. Total value of awards by fiscal year.

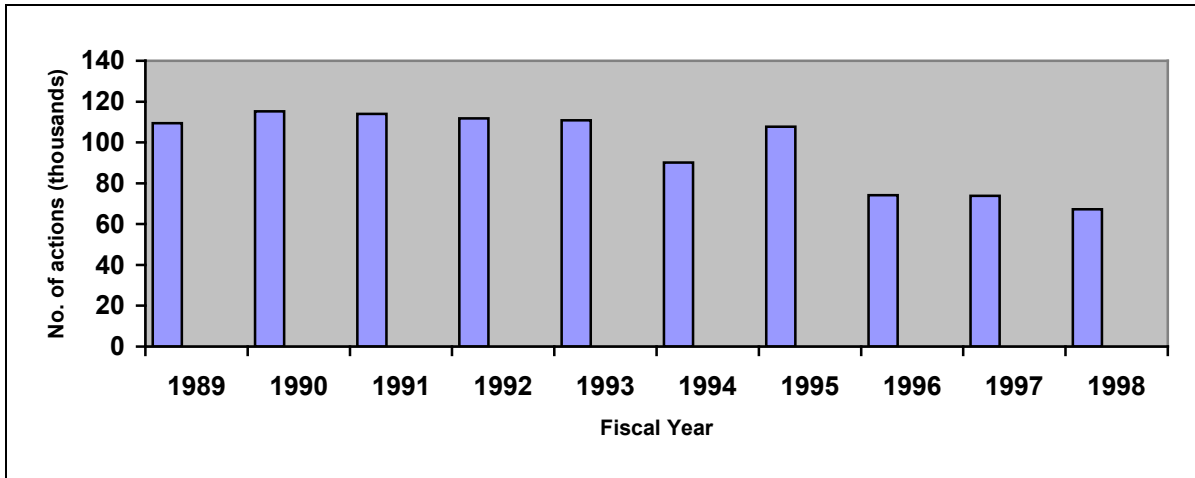

Figure 7-12. Total number of procurement actions by fiscal year: FY 1989–FY 1998.

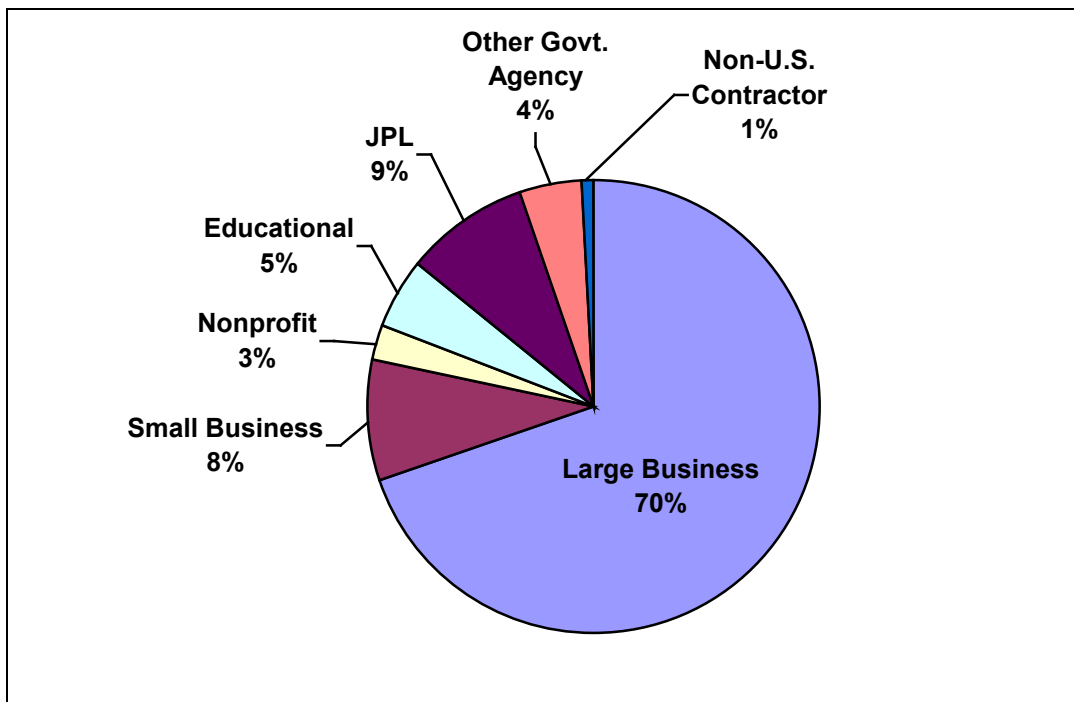

Figure 7-13. Percentage of procurement award value by type of contractor: FY 1989–FY 1998.

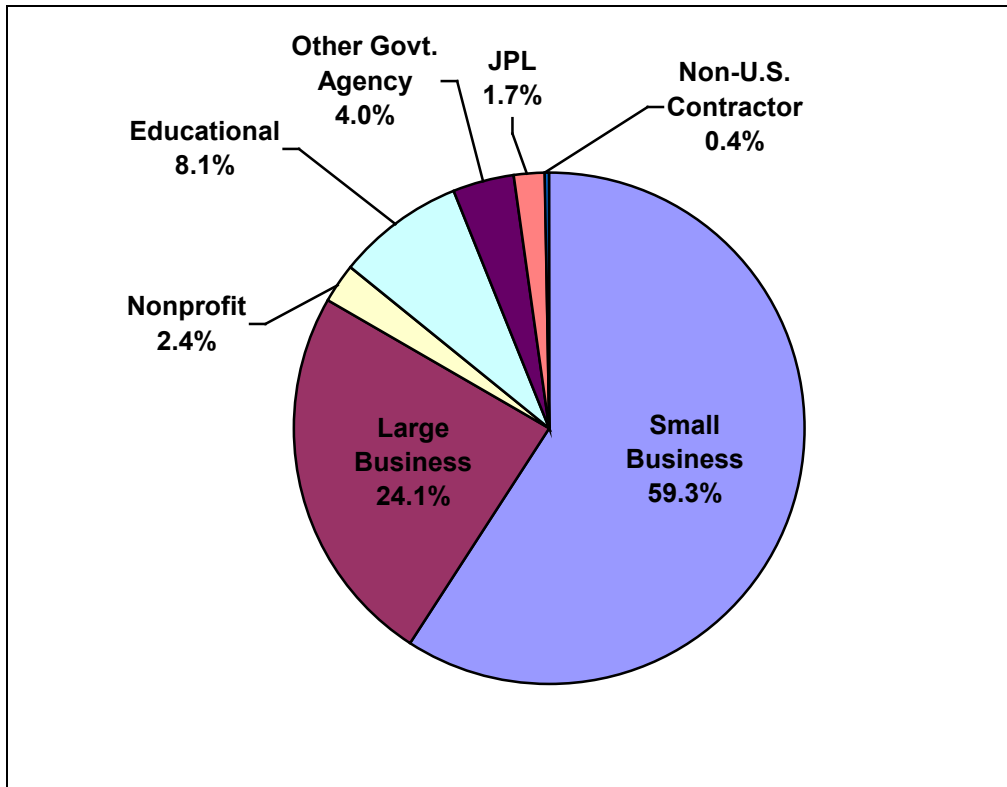

Figure 7-14. Average percentage of procurement actions by type of contractor: FY 1989–FY 1998.

NASA used a variety of acquisition approaches and contract types for its procurements. The largest number and greatest percentage of these procurements were for competitive contracts, including fixed-price, incentive, cost-plus-award-fee, cost-plus-fixed-fee, and a small number of other types of competitive contracts (tables 7-21 to 7-23). Cost-plus-award-fee contracts were a common type of contract used for large competitive contracts to support complex requirements.

Every state in the United States and the District of Columbia received NASA contracts during the decade.⁶ On a state-by-state basis, California consistently received awards of the greatest value. Texas and Florida also led in award value (see table 7-24). Looking at NASA’s awards regionally, at the beginning of the decade, the Southeast and Far West had been awarded NASA contracts with the greatest value. By the end of the decade, the Southwest was receiving contracts with a greater value than the rest of the country. During the decade, the value of contract awards rose in the New England, Mideast, Great Lakes, and Rocky Mountain regions, as well as in Alaska and Hawaii (see figure 7-15). The value of contracts awarded to companies in the Southeast, Plains, and Far West regions fell during the decade (see table 7-25).

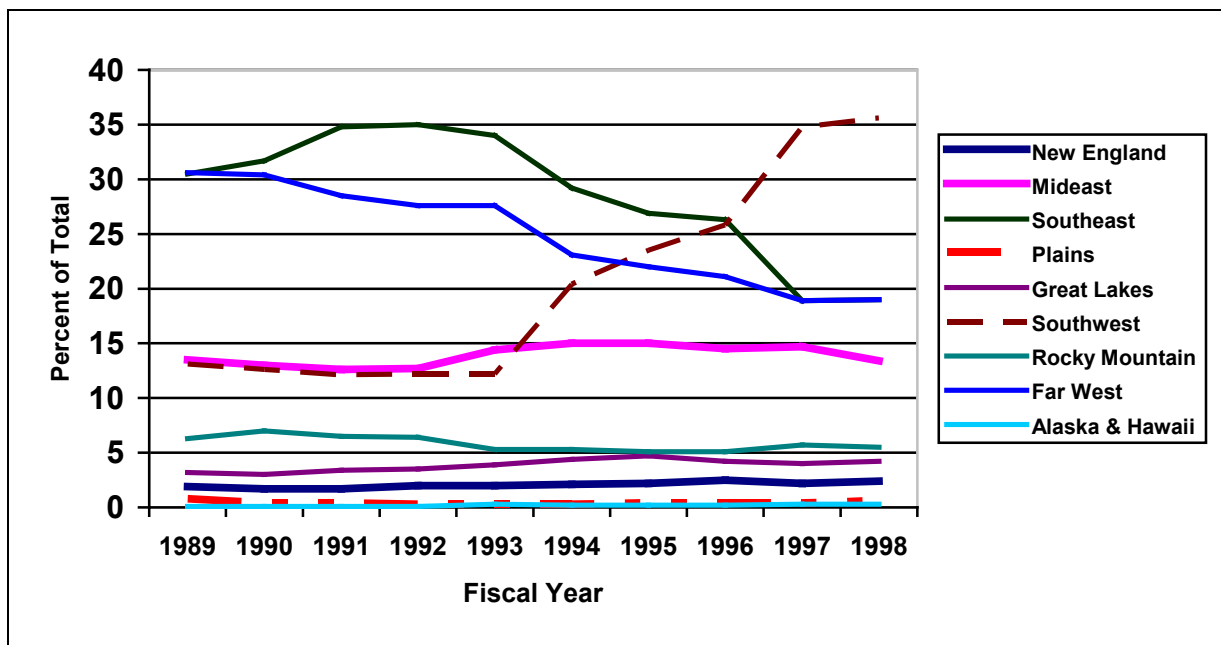

Figure 7-15. Distribution of number of prime contract awards by region: FY 1989–FY 1998.

⁶ NASA does not award contracts based on an organization’s location except in the case of special programs, such as the congressionally authorized Historically Underutilized Business Zones (HUB Zone) program.

Through FY 1993, Marshall Space Flight Center and Johnson Space Center were awarded contracts with the greatest value, with Marshall at the top position. In FY 1994 and FY 1995, Goddard Space Flight Center's contracts had a higher value than those awarded to Johnson. Johnson moved to the top position in FY 1996, with Goddard second and Marshall in third place (see table 7-26). Rockwell International remained NASA's top contractor through FY 1994, a position it had held since FY 1973. Lockheed Space Operations and McDonnell Douglas kept the number two and three slots, occasionally reversing order. In FY 1994, the Boeing Company moved into the top slot, and kept that position for the rest of the decade. Several mergers and acquisitions of companies took place during the decade (the most notable being the merger of Lockheed and Martin Marietta), which affected the rankings of these companies. Rockwell also became part of Boeing North American (not to be confused with the Boeing Company; see table 7-27). In all, NASA's top 50 contractors received contracts valued between 81 percent and 85 percent of the total value of all NASA contracts (see tables 7-28 to 7-37). Of the nonprofit and educational institutions that received NASA awards, Stanford University remained at the top position through FY 1997. It moved into second place in FY 1998 when it was replaced by Johns Hopkins University.⁷ The Association of Universities for Research in Astronomy (AURA), a nonprofit institution, remained in second place through FY 1995 and moved into third place for the remainder of the decade (see tables 7-38 to 7-47). Figure 7-16 shows a breakdown of the total value of NASA's business and educational/nonprofit awards by fiscal year.

⁷ The contract with the California Institute of Technology (Caltech) for work conducted by the Jet Propulsion Laboratory is excluded from this group of institutions.

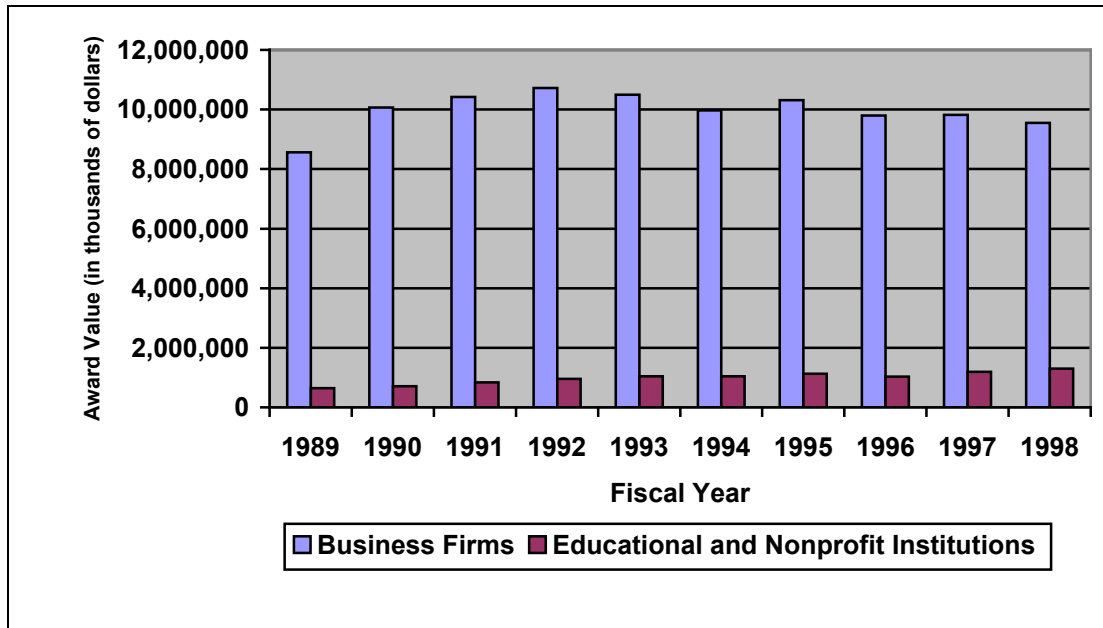

Figure 7-16. Total value of business and educational and nonprofit awards by fiscal year (in thousands of dollars).

*NASA's Procurement Process*⁸

The Federal Acquisition Regulation (FAR), supplemented by the NASA FAR Supplement (NFS), provides the regulatory framework for NASA's procurement process. For the 1989–1998 period, the majority of NASA's contracts were competitive procurements.⁹ NASA's competitive procurement process consists of several steps, including

- preparing a procurement request (PR);
- developing an acquisition plan;
- synopsisizing the requirement;
- issuing the solicitation;
- preparing and submitting proposals by contractors;

⁸ This section describes the procurement process as it existed during the years 1989–1998. Reference sources have been taken primarily from that period, and the process may have changed significantly since then.

⁹ During this decade, competitive procurements ranged from 54 percent to 81 percent of total procurements. See table 7-22 for details.

- evaluating the bids or proposals;
- selecting, negotiating, and awarding the contract;
- administrating the contract;
- closing out the contract.

Procurement Request (PR)

The PR describes NASA's requirements to procure goods or services to fulfill a mission need. Generally, NASA strives to describe requirements in terms of the outcomes and outputs (the results and functions) the contractor must deliver to satisfy minimum mission needs, rather than mandating detailed design specifications. Additionally, the Federal Acquisition Streamlining Act of 1994 requires federal agencies to conduct market research to help define an agency's requirements by determining whether sources of commercial items or services are available to satisfy them. Procurements over a certain dollar amount also require an in-house cost estimate that provides the government's best estimate of the actual price of the procurement.

Before a solicitation is issued, the most appropriate acquisition strategy (e.g., simplified acquisition procedures, acquisition of commercial items, formal source evaluation procedures, etc.) and contract type (cost reimbursement, fixed price, etc.) are selected. The contracting officer is responsible for selecting the contract type. Additionally, each award must be considered in terms of whether it can be limited to small businesses.

Contract types are grouped into two broad categories: fixed-price contracts and cost-reimbursement contracts. Specific contract types range from firm-fixed-price, in which the

contractor has full responsibility for the performance costs and resulting profit (or loss), to cost-plus-fixed-fee, in which the contractor has minimal responsibility for the performance costs and the negotiated fee (profit) is fixed. Various types of incentive contracts in which the contractor's responsibility for the performance costs and the profit or fee incentives offered are tailored to the uncertainties involved in contract performance fall in between.¹⁰

The FAR lists several factors that influence the selection and negotiation of contract type. They include

- price competition,
- price analysis,
- cost analysis,
- type and complexity of the requirement,
- urgency of the requirement,
- period of performance or length of production run,
- contractor's technical capability and financial responsibility,
- adequacy of the contractor's accounting system,
- concurrent contracts,
- extent and nature of proposed subcontracting,
- acquisition history.¹¹

A fixed-price contract offers the least amount of risk to the government and the most risk to the

¹⁰ Federal Acquisition Regulations, Section 16.102, "Selecting Contract Types—Policies," <http://www.arnet.gov/far/97-03/html/16.html#16.104> (accessed 7 May 2007).

¹¹ Federal Acquisition Regulations, Section 16.104, "Factors in Selecting Contract Types," <http://www.arnet.gov/far/97-03/html/16.html#16.104> (accessed 7 May 2007).

contractor. Under such contracts the contractor is paid a fixed price for completing the required work within the allotted time. A cost-reimbursement contract results in the most risk to the government and the least risk to the contractor. Complex requirements, particularly those that are unique to the government, usually result in the government assuming greater risk. This is especially true for complex R&D contracts. In such cases, performance uncertainties and the likelihood that changes will be required make it difficult to estimate performance costs in advance. As a requirement recurs or quantity production begins, the cost risk shifts to the contractor and a fixed-price contract is usually considered.¹²

For complex requirements, often a Work Breakdown Structure (WBS) is prepared that defines all the work necessary to complete the project; provides a product-oriented, hierarchical division of deliverable items and associated services; and relates the elements of work to each other and to the end system or product.¹³ In addition, a Statement of Work (SOW) defines the work to be performed.

Procurement Plan

A procurement plan is an administrative tool designed to help the contracting officer plan effectively to accomplish an assigned procurement by analyzing the requirements and determining the appropriate procurement method. It consists of a detailed outline of the method by which the contracting officer expects to accomplish the procurement. The contracting officer prepares the procurement plan with the advice and assistance of the appropriate technical division and other appropriate organizations for procurement actions as required by NASA's

¹² Federal Acquisition Regulations, Part 16, "Types of Contracts," <http://www.arnet.gov/far/97-03/html/16.html#16.104> (accessed 7 May 2007).

¹³ NASA Handbook 7120.5, *Management of Major System Programs and Projects*, 8 November 1993, p. 5-D-1.

procurement regulations. The plan is prepared before proposals are solicited for the initial phase or increment of the program or project.¹⁴

Solicitation of Proposals

If the items to be procured can be defined in advance with a great degree of accuracy, formal advertising for competitive bids takes place, and the government releases an Invitation for Bid (IFB) to interested suppliers. Firm-fixed-price contracts are used when the method of contracting is sealed bidding; fixed-price contracts with economic price adjustment clauses may be used when some flexibility is necessary and feasible.¹⁵

More often, the items, systems, or services cannot be completely defined, and a cost-reimbursement contract is awarded. This type of contract allows for government payment of reasonable allowable costs as defined in the FAR or in the contract provisions.¹⁶ In a cost-reimbursement contract, the contractor is required only to make its “best effort” to complete the work.¹⁷ Cost-plus-award-fee and cost-plus-fixed-fee are two common types of cost-reimbursement contracts.

For a cost-reimbursement contract, the government issues a Request for Proposal (RFP). The RFP contains a complete and specific description of the items or services to be procured, all

¹⁴ *NASA Far Supplement*, Part 1807, “Acquisition Planning,” Subpart 1807.1, <http://farsite.hill.af.mil/archive/NFS/89.20/N07.HTM> (accessed 15 January 2007).

¹⁵ Federal Acquisition Regulations, FAC 97–06, Part 14 “Sealed Bidding,” 1 October 1998, <http://acquisition.gov/far/97-06/html/14.html> (accessed 4 June 2007).

¹⁶ According to Section 31.201-3 of the FAR, “a cost is reasonable if, in its nature and amount, it does not exceed that which would be incurred by a prudent person in the conduct of competitive business.” <http://www.arnet.gov/far/97-03/html/31.html> (accessed 16 January 2007).

¹⁷ “Award Fee Contracting Guide,” 2 December 1997, <http://www.hq.nasa.gov/office/procurement/regs/afguidee.html> (accessed 13 May 1998).

applicable specifications, quantities, time and place of delivery, method of shipment, and other requirements. To reduce the government's time and expense needed to prepare major RFPs and evaluate proposals, the solicitation is normally restricted to those contractors that NASA determines can adequately fulfill the mission needs, and have an interest in the procurement. During the decade from 1989 to 1998, the *Commerce Business Daily* (CBD), which published five or six daily editions weekly, was the prime public notification media by which U.S. government agencies identified proposed contract actions and contract awards. The CBD was available to everyone, and readers were allowed to submit proposals if they were interested. Additionally, the contracting officer could provide copies of the solicitation to interested contractors. Toward the end of the decade, federal government Web sites also came online to provide electronic postings of solicitations.¹⁸

Evaluation and Award

The evaluation of bids is a straightforward process. As long as NASA is assured that the bidder can provide the items or services specified in the IFB, the lowest bidder receives the award.

The evaluation of competitive proposals submitted in response to RFPs is more complex than the evaluation of bids. In general, the proposal evaluation assesses the offeror's ability to perform the prospective contract successfully. According to procedures set forth in the FAR, an agency must evaluate competitive proposals and assess their relative qualities based solely on the factors and subfactors specified in the solicitation. The weight given to each area must be included in the solicitation and strictly used to evaluate the proposals. Key areas of importance include factors such as cost or price, past performance, and technical competence, which are tailored to the

¹⁸ Federal Acquisition Regulations, FAC 97-02, Subpart 5.101, "Methods of Disseminating Information."

acquisition. Typically, NASA establishes three evaluation factors: Mission Suitability, Cost/Price, and Past Performance. Evaluation factors may be further defined by subfactors.¹⁹ The estimated cost of the procurement influences, to some extent, the areas that are evaluated. The RFP spells out the relative weight given to each factor and to the subareas within each factor. The solicitation also states how the combined weight of all evaluation factors other than cost or price compare in importance to cost or price. In all cases, the objective of source selection is to select the proposal that represents the best value to the government.²⁰

A Source Evaluation Board, through a formal process, evaluates contracts over a certain dollar level. Members of the organization that will administer the contract, and contract specialists within NASA's Procurement Office evaluate smaller procurements.

Selection, Negotiation, and Award

For cost-reimbursement contracts above a certain price level, once a firm is selected, additional details can still be negotiated before the contract is awarded. Any cost-related provision can be negotiated, including (but not limited to) the number of labor hours, travel expenses, overhead rates, and other direct costs. The question of fee, an amount in addition to the basic contract cost, must be settled. The fee can be a fixed amount specified in the contract, providing the contract requirements are met, or it can vary depending on regular evaluations of the contractor's performance. The method of addressing inflation or escalating costs is another area that is negotiated. Following the completion of negotiations, the contract is awarded and work can begin.

¹⁹ NASA FAR Supplement, Part 1815, "NASA Evaluation Factors," http://www.hq.nasa.gov/office/procurement/regs/1815.htm#15_3 (accessed 11 May 2007).

²⁰ Federal Acquisition Regulations, FAC 97-02, Subpart 15.3, "Source Selection."

Contract Management and Administration

Contract administration consists of all activities that take place from the time the contract is awarded until it is closed out. NASA has a large number of procedures in place to ensure that its contracts are managed efficiently and legally. For procurement of an item, the delivery of that item may be the only major requirement. However, for administering the procurement of complicated systems or services, the government provides considerable oversight, and the contractor is responsible for providing regular information to the government regarding the cost and progress of the work. The government reviews and evaluates this information, and may find that revisions to the contract or changes in project plans are necessary because of what these progress reports reveal. NASA employs a number of individuals who are responsible for contract administration.

Definition of Terms

Competitive procurements are those in which offers are solicited from more than one responsible offeror that is capable of satisfying the government's requirements wholly or partially, and the award or awards are made based on price, design, or technical competition.

Other-than-competitive procurements are those in which an offer is solicited and received from only one responsible offeror that is capable of satisfying the government's requirements wholly or partially. (This category includes contracts resulting from unsolicited proposals.) These are also called "sole source acquisitions."²¹

²¹ Federal Acquisition Regulations, FAC 97-02, Subpart 16.003.

Contracting action is an action that results in a contract, including contract modifications for additional supplies or services, but not including contract modifications that are within the scope and under the terms of the contract, such as contract modifications issued pursuant to the Changes clause, or funding and other administrative changes.²² Full and open competition, when used with respect to a contract action, means that all responsible sources are permitted to compete. A contracting action includes the following types of agreements:

- letter contracts or other preliminary notices of negotiated awards;
- definitive contracts, including purchase orders;
- orders under GSA Federal Supply Schedule contracts, basic ordering agreements, and against indefinite delivery type contracts;
- intragovernmental orders;
- grants;
- cooperative and Space Act agreements;
- supplemental agreements, change orders, administrative changes, and terminations to existing procurements.

A *prime contract* is a contract into which NASA enters directly.

A *small business concern*, for purposes of government procurement, means an independently owned and operated concern, including its affiliates, that is not dominant in the field of operation in which it is bidding, and is qualified as a small business under the criteria and size standards in Title 13 of the Code of Federal Regulations and in the FAR, Part 19, Subpart 19.1. Such a concern is “not dominant in its field of operation” when it does not exercise a controlling or

²² Federal Acquisition Regulations, FAC 97-02, Subpart 5.001.

major influence on a national basis in a kind of business activity in which a number of business concerns are primarily engaged. For service industries, the size standard generally is based on average annual receipts over a three-year period, depending on the service to be procured. Generally, in the case of agricultural or manufactured products, the size standards are determined by the number of employees. The applicable size standard is prescribed in each NASA solicitation.²³

²³ Federal Acquisition Regulations, FAC 97-02, Subpart 19.1.

The NASA History Series

Reference Works, NASA SP-4000:

Grimwood, James M. *Project Mercury: A Chronology*. NASA SP-4001, 1963.

Grimwood, James M., and Barton C. Hacker, with Peter J. Vorzimmer. *Project Gemini Technology and Operations: A Chronology*. NASA SP-4002, 1969.

Link, Mae Mills. *Space Medicine in Project Mercury*. NASA SP-4003, 1965.

Astronautics and Aeronautics, 1963: Chronology of Science, Technology, and Policy. NASA SP-4004, 1964.

Astronautics and Aeronautics, 1964: Chronology of Science, Technology, and Policy. NASA SP-4005, 1965.

Astronautics and Aeronautics, 1965: Chronology of Science, Technology, and Policy. NASA SP-4006, 1966.

Astronautics and Aeronautics, 1966: Chronology of Science, Technology, and Policy. NASA SP-4007, 1967.

Astronautics and Aeronautics, 1967: Chronology of Science, Technology, and Policy. NASA SP-4008, 1968.

Ertel, Ivan D., and Mary Louise Morse. *The Apollo Spacecraft: A Chronology, Volume I, Through November 7, 1962*. NASA SP-4009, 1969.

Morse, Mary Louise, and Jean Kernahan Bays. *The Apollo Spacecraft: A Chronology, Volume II, November 8, 1962–September 30, 1964*. NASA SP-4009, 1973.

Brooks, Courtney G., and Ivan D. Ertel. *The Apollo Spacecraft: A Chronology, Volume III, October 1, 1964–January 20, 1966*. NASA SP-4009, 1973.

Ertel, Ivan D., and Roland W. Newkirk, with Courtney G. Brooks. *The Apollo Spacecraft: A Chronology, Volume IV, January 21, 1966–July 13, 1974*. NASA SP-4009, 1978.

Astronautics and Aeronautics, 1968: Chronology of Science, Technology, and Policy. NASA SP-4010, 1969.

Newkirk, Roland W., and Ivan D. Ertel, with Courtney G. Brooks. *Skylab: A Chronology*. NASA SP-4011, 1977.

Van Nimmen, Jane, and Leonard C. Bruno, with Robert L. Rosholt. *NASA Historical Data Book, Volume I: NASA Resources, 1958–1968*. NASA SP-4012, 1976; rep. ed. 1988.

Ezell, Linda Neuman. *NASA Historical Data Book, Volume II: Programs and Projects, 1958–1968*. NASA SP-4012, 1988.

Ezell, Linda Neuman. *NASA Historical Data Book, Volume III: Programs and Projects, 1969–1978*. NASA SP-4012, 1988.

Gawdiak, Ihor, with Helen Fedor. *NASA Historical Data Book, Volume IV: NASA Resources, 1969–1978*. NASA SP-4012, 1994.

Rumerman, Judy A. *NASA Historical Data Book, Volume V: NASA Launch Systems, Space Transportation, Human Spaceflight, and Space Science, 1979–1988*. NASA SP-4012, 1999.

Rumerman, Judy A. *NASA Historical Data Book, Volume VI: NASA Space Applications,*

Aeronautics and Space Research and Technology, Tracking and Data Acquisition/Support Operations, Commercial Programs, and Resources, 1979–1988. NASA SP-4012, 1999.

Rumerman, Judy A. *NASA Historical Data Book, Volume VII: NASA Launch Systems, Space Transportation, Human Spaceflight, and Space Science, 1989–1998.* NASA SP-2009-4012, 2009.

No SP-4013.

Astronautics and Aeronautics, 1969: Chronology of Science, Technology, and Policy. NASA SP-4014, 1970.

Astronautics and Aeronautics, 1970: Chronology of Science, Technology, and Policy. NASA SP-4015, 1972.

Astronautics and Aeronautics, 1971: Chronology of Science, Technology, and Policy. NASA SP-4016, 1972.

Astronautics and Aeronautics, 1972: Chronology of Science, Technology, and Policy. NASA SP-4017, 1974.

Astronautics and Aeronautics, 1973: Chronology of Science, Technology, and Policy. NASA SP-4018, 1975.

Astronautics and Aeronautics, 1974: Chronology of Science, Technology, and Policy. NASA SP-4019, 1977.

Astronautics and Aeronautics, 1975: Chronology of Science, Technology, and Policy. NASA SP-4020, 1979.

Astronautics and Aeronautics, 1976: Chronology of Science, Technology, and Policy. NASA SP-4021, 1984.

Astronautics and Aeronautics, 1977: Chronology of Science, Technology, and Policy. NASA SP-4022, 1986.

Astronautics and Aeronautics, 1978: Chronology of Science, Technology, and Policy. NASA SP-4023, 1986.

Astronautics and Aeronautics, 1979–1984: Chronology of Science, Technology, and Policy. NASA SP-4024, 1988.

Astronautics and Aeronautics, 1985: Chronology of Science, Technology, and Policy. NASA SP-4025, 1990.

Noordung, Hermann. *The Problem of Space Travel: The Rocket Motor.* Edited by Ernst Stuhlinger and J. D. Hunley, with Jennifer Garland. NASA SP-4026, 1995.

Astronautics and Aeronautics, 1986–1990: A Chronology. NASA SP-4027, 1997.

Astronautics and Aeronautics, 1991–1995: A Chronology. NASA SP-2000-4028, 2000.

Orloff, Richard W. *Apollo by the Numbers: A Statistical Reference.* NASA SP-2000-4029, 2000.

Lewis, Marieke, and Ryan Swanson. *Astronautics and Aeronautics: A Chronology, 1996–2000.* NASA SP-2009-4030, 2009.

Ivey, William Noel, and Ryan Swanson. *Astronautics and Aeronautics: A Chronology, 2001–2005.* NASA SP-2010-4031, 2010.

Management Histories, NASA SP-4100:

Rosholt, Robert L. *An Administrative History of NASA, 1958–1963*. NASA SP-4101, 1966.

Levine, Arnold S. *Managing NASA in the Apollo Era*. NASA SP-4102, 1982.

Roland, Alex. *Model Research: The National Advisory Committee for Aeronautics, 1915–1958*. NASA SP-4103, 1985.

Fries, Sylvia D. *NASA Engineers and the Age of Apollo*. NASA SP-4104, 1992.

Glennan, T. Keith. *The Birth of NASA: The Diary of T. Keith Glennan*. Edited by J. D. Hunley. NASA SP-4105, 1993.

Seamans, Robert C. *Aiming at Targets: The Autobiography of Robert C. Seamans*. NASA SP-4106, 1996.

Garber, Stephen J., ed. *Looking Backward, Looking Forward: Forty Years of Human Spaceflight Symposium*. NASA SP-2002-4107, 2002.

Mallick, Donald L., with Peter W. Merlin. *The Smell of Kerosene: A Test Pilot's Odyssey*. NASA SP-4108, 2003.

Iloff, Kenneth W., and Curtis L. Peebles. *From Runway to Orbit: Reflections of a NASA Engineer*. NASA SP-2004-4109, 2004.

Chertok, Boris. *Rockets and People, Volume I*. NASA SP-2005-4110, 2005.

Chertok, Boris. *Rockets and People: Creating a Rocket Industry, Volume II*. NASA SP-2006-4110, 2006.

Chertok, Boris. *Rockets and People: Hot Days of the Cold War, Volume III*. NASA SP-2009-4110, 2009.

Chertok, Boris. *Rockets and People: The Moon Race, Volume IV*. NASA SP-2011-4110, 2011.

Laufer, Alexander, Todd Post, and Edward Hoffman. *Shared Voyage: Learning and Unlearning from Remarkable Projects*. NASA SP-2005-4111, 2005.

Dawson, Virginia P., and Mark D. Bowles. *Realizing the Dream of Flight: Biographical Essays in Honor of the Centennial of Flight, 1903–2003*. NASA SP-2005-4112, 2005.

Mudgway, Douglas J. *William H. Pickering: America's Deep Space Pioneer*. NASA SP-2008-4113, 2008.

Project Histories, NASA SP-4200:

Swenson, Loyd S., Jr., James M. Grimwood, and Charles C. Alexander. *This New Ocean: A History of Project Mercury*. NASA SP-4201, 1966; rep. ed. 1999.

Green, Constance McLaughlin, and Milton Lomask. *Vanguard: A History*. NASA SP-4202, 1970; rep. ed. Smithsonian Institution Press, 1971.

Hacker, Barton C., and James M. Grimwood. *On the Shoulders of Titans: A History of Project Gemini*. NASA SP-4203, 1977; rep. ed. 2002.

Benson, Charles D., and William Barnaby Faherty. *Moonport: A History of Apollo Launch Facilities and Operations*. NASA SP-4204, 1978.

Brooks, Courtney G., James M. Grimwood, and Loyd S. Swenson, Jr. *Chariots for Apollo: A*

History of Manned Lunar Spacecraft. NASA SP-4205, 1979.

Bilstein, Roger E. *Stages to Saturn: A Technological History of the Apollo/Saturn Launch Vehicles*. NASA SP-4206, 1980 and 1996.

No SP-4207.

Compton, W. David, and Charles D. Benson. *Living and Working in Space: A History of Skylab*. NASA SP-4208, 1983.

Ezell, Edward Clinton, and Linda Neuman Ezell. *The Partnership: A History of the Apollo-Soyuz Test Project*. NASA SP-4209, 1978.

Hall, R. Cargill. *Lunar Impact: A History of Project Ranger*. NASA SP-4210, 1977.

Newell, Homer E. *Beyond the Atmosphere: Early Years of Space Science*. NASA SP-4211, 1980.

Ezell, Edward Clinton, and Linda Neuman Ezell. *On Mars: Exploration of the Red Planet, 1958–1978*. NASA SP-4212, 1984.

Pitts, John A. *The Human Factor: Biomedicine in the Manned Space Program to 1980*. NASA SP-4213, 1985.

Compton, W. David. *Where No Man Has Gone Before: A History of Apollo Lunar Exploration Missions*. NASA SP-4214, 1989.

Naugle, John E. *First Among Equals: The Selection of NASA Space Science Experiments*. NASA SP-4215, 1991.

Wallace, Lane E. *Airborne Trailblazer: Two Decades with NASA Langley's 737 Flying Laboratory*. NASA SP-4216, 1994.

Butrica, Andrew J., ed. *Beyond the Ionosphere: Fifty Years of Satellite Communications*. NASA SP-4217, 1997.

Butrica, Andrew J. *To See the Unseen: A History of Planetary Radar Astronomy*. NASA SP-4218, 1996.

Mack, Pamela E., ed. *From Engineering Science to Big Science: The NACA and NASA Collier Trophy Research Project Winners*. NASA SP-4219, 1998.

Reed, R. Dale. *Wingless Flight: The Lifting Body Story*. NASA SP-4220, 1998.

Heppenheimer, T. A. *The Space Shuttle Decision: NASA's Search for a Reusable Space Vehicle*. NASA SP-4221, 1999.

Hunley, J. D., ed. *Toward Mach 2: The Douglas D-558 Program*. NASA SP-4222, 1999.

Swanson, Glen E., ed. *"Before This Decade Is Out..." Personal Reflections on the Apollo Program*. NASA SP-4223, 1999.

Tomayko, James E. *Computers Take Flight: A History of NASA's Pioneering Digital Fly-By-Wire Project*. NASA SP-4224, 2000.

Morgan, Clay. *Shuttle-Mir: The United States and Russia Share History's Highest Stage*. NASA SP-2001-4225, 2001.

Leary, William M. *"We Freeze to Please": A History of NASA's Icing Research Tunnel and the Quest for Safety*. NASA SP-2002-4226, 2002.

Mudgway, Douglas J. *Uplink-Downlink: A History of the Deep Space Network, 1957–1997*. NASA SP-2001-4227, 2001.

No SP-4228 or SP-4229.

Dawson, Virginia P., and Mark D. Bowles. *Taming Liquid Hydrogen: The Centaur Upper Stage Rocket, 1958–2002*. NASA SP-2004-4230, 2004.

Meltzer, Michael. *Mission to Jupiter: A History of the Galileo Project*. NASA SP-2007-4231, 2007.

Heppenheimer, T. A. *Facing the Heat Barrier: A History of Hypersonics*. NASA SP-2007-4232, 2007.

Tsiao, Sunny. “*Read You Loud and Clear!*” *The Story of NASA’s Spaceflight Tracking and Data Network*. NASA SP-2007-4233, 2007.

Meltzer, Michael. *When Biospheres Collide: A History of NASA’s Planetary Protection Programs*. NASA SP-2011-4234, 2011.

Center Histories, NASA SP-4300:

Rosenthal, Alfred. *Venture into Space: Early Years of Goddard Space Flight Center*. NASA SP-4301, 1985.

Hartman, Edwin P. *Adventures in Research: A History of Ames Research Center, 1940–1965*. NASA SP-4302, 1970.

Hallion, Richard P. *On the Frontier: Flight Research at Dryden, 1946–1981*. NASA SP-4303, 1984.

Muenger, Elizabeth A. *Searching the Horizon: A History of Ames Research Center, 1940–1976*. NASA SP-4304, 1985.

Hansen, James R. *Engineer in Charge: A History of the Langley Aeronautical Laboratory, 1917–1958*. NASA SP-4305, 1987.

Dawson, Virginia P. *Engines and Innovation: Lewis Laboratory and American Propulsion Technology*. NASA SP-4306, 1991.

Dethloff, Henry C. “*Suddenly Tomorrow Came...*”: *A History of the Johnson Space Center, 1957–1990*. NASA SP-4307, 1993.

Hansen, James R. *Spaceflight Revolution: NASA Langley Research Center from Sputnik to Apollo*. NASA SP-4308, 1995.

Wallace, Lane E. *Flights of Discovery: An Illustrated History of the Dryden Flight Research Center*. NASA SP-4309, 1996.

Herring, Mack R. *Way Station to Space: A History of the John C. Stennis Space Center*. NASA SP-4310, 1997.

Wallace, Harold D., Jr. *Wallops Station and the Creation of an American Space Program*. NASA SP-4311, 1997.

Wallace, Lane E. *Dreams, Hopes, Realities. NASA’s Goddard Space Flight Center: The First Forty Years*. NASA SP-4312, 1999.

Dunar, Andrew J., and Stephen P. Waring. *Power to Explore: A History of Marshall Space Flight Center, 1960–1990*. NASA SP-4313, 1999.

Bugos, Glenn E. *Atmosphere of Freedom: Sixty Years at the NASA Ames Research Center*. NASA SP-2000-4314, 2000.

No SP-4315.

Schultz, James. *Crafting Flight: Aircraft Pioneers and the Contributions of the Men and Women of NASA Langley Research Center*. NASA SP-2003-4316, 2003.

Bowles, Mark D. *Science in Flux: NASA's Nuclear Program at Plum Brook Station, 1955–2005*. NASA SP-2006-4317, 2006.

Wallace, Lane E. *Flights of Discovery: An Illustrated History of the Dryden Flight Research Center*. NASA SP-2007-4318, 2007. Revised version of NASA SP-4309.

Arrighi, Robert S. *Revolutionary Atmosphere: The Story of the Altitude Wind Tunnel and the Space Power Chambers*. NASA SP-2010-4319, 2010.

General Histories, NASA SP-4400:

Corliss, William R. *NASA Sounding Rockets, 1958–1968: A Historical Summary*. NASA SP-4401, 1971.

Wells, Helen T., Susan H. Whiteley, and Carrie Karegeannes. *Origins of NASA Names*. NASA SP-4402, 1976.

Anderson, Frank W., Jr. *Orders of Magnitude: A History of NACA and NASA, 1915–1980*. NASA SP-4403, 1981.

Sloop, John L. *Liquid Hydrogen as a Propulsion Fuel, 1945–1959*. NASA SP-4404, 1978.

Roland, Alex. *A Spacefaring People: Perspectives on Early Spaceflight*. NASA SP-4405, 1985.

Bilstein, Roger E. *Orders of Magnitude: A History of the NACA and NASA, 1915–1990*. NASA SP-4406, 1989.

Logsdon, John M., ed., with Linda J. Lear, Janelle Warren Findley, Ray A. Williamson, and Dwayne A. Day. *Exploring the Unknown: Selected Documents in the History of the U.S. Civil Space Program, Volume I: Organizing for Exploration*. NASA SP-4407, 1995.

Logsdon, John M., ed., with Dwayne A. Day and Roger D. Launius. *Exploring the Unknown: Selected Documents in the History of the U.S. Civil Space Program, Volume II: External Relationships*. NASA SP-4407, 1996.

Logsdon, John M., ed., with Roger D. Launius, David H. Onkst, and Stephen J. Garber. *Exploring the Unknown: Selected Documents in the History of the U.S. Civil Space Program, Volume III: Using Space*. NASA SP-4407, 1998.

Logsdon, John M., ed., with Ray A. Williamson, Roger D. Launius, Russell J. Acker, Stephen J. Garber, and Jonathan L. Friedman. *Exploring the Unknown: Selected Documents in the History of the U.S. Civil Space Program, Volume IV: Accessing Space*. NASA SP-4407, 1999.

Logsdon, John M., ed., with Amy Paige Snyder, Roger D. Launius, Stephen J. Garber, and Regan Anne Newport. *Exploring the Unknown: Selected Documents in the History of the U.S. Civil Space Program, Volume V: Exploring the Cosmos*. NASA SP-2001-4407, 2001.

Logsdon, John M., ed., with Stephen J. Garber, Roger D. Launius, and Ray A. Williamson. *Exploring the Unknown: Selected Documents in the History of the U.S. Civil Space Program, Volume VI: Space and Earth Science*. NASA SP-2004-4407, 2004.

Logsdon, John M., ed., with Roger D. Launius. *Exploring the Unknown: Selected Documents*

in the History of the U.S. Civil Space Program, Volume VII: Human Spaceflight: Projects Mercury, Gemini, and Apollo. NASA SP-2008-4407, 2008.

Siddiqi, Asif A., *Challenge to Apollo: The Soviet Union and the Space Race, 1945–1974.* NASA SP-2000-4408, 2000.

Hansen, James R., ed. *The Wind and Beyond: Journey into the History of Aerodynamics in America, Volume 1: The Ascent of the Airplane.* NASA SP-2003-4409, 2003.

Hansen, James R., ed. *The Wind and Beyond: Journey into the History of Aerodynamics in America, Volume 2: Reinventing the Airplane.* NASA SP-2007-4409, 2007.

Hogan, Thor. *Mars Wars: The Rise and Fall of the Space Exploration Initiative.* NASA SP-2007-4410, 2007.

Vakoch, Douglas A., ed. *Psychology of Space Exploration: Contemporary Research in Historical Perspective.* NASA SP-2011-4411, 2011.

Monographs in Aerospace History, NASA SP-4500:

Launius, Roger D., and Aaron K. Gillette, comps. *Toward a History of the Space Shuttle: An Annotated Bibliography.* Monographs in Aerospace History, No. 1, 1992.

Launius, Roger D., and J. D. Hunley, comps. *An Annotated Bibliography of the Apollo Program.* Monographs in Aerospace History, No. 2, 1994.

Launius, Roger D. *Apollo: A Retrospective Analysis.* Monographs in Aerospace History, No. 3, 1994.

Hansen, James R. *Enchanted Rendezvous: John C. Houbolt and the Genesis of the Lunar-Orbit Rendezvous Concept.* Monographs in Aerospace History, No. 4, 1995.

Gorn, Michael H. *Hugh L. Dryden's Career in Aviation and Space.* Monographs in Aerospace History, No. 5, 1996.

Powers, Sheryll Goecke. *Women in Flight Research at NASA Dryden Flight Research Center from 1946 to 1995.* Monographs in Aerospace History, No. 6, 1997.

Portree, David S. F., and Robert C. Trevino. *Walking to Olympus: An EVA Chronology.* Monographs in Aerospace History, No. 7, 1997.

Logsdon, John M., moderator. *Legislative Origins of the National Aeronautics and Space Act of 1958: Proceedings of an Oral History Workshop.* Monographs in Aerospace History, No. 8, 1998.

Rumerman, Judy A., comp. *U.S. Human Spaceflight: A Record of Achievement, 1961–1998.* Monographs in Aerospace History, No. 9, 1998.

Portree, David S. F. *NASA's Origins and the Dawn of the Space Age.* Monographs in Aerospace History, No. 10, 1998.

Logsdon, John M. *Together in Orbit: The Origins of International Cooperation in the Space Station.* Monographs in Aerospace History, No. 11, 1998.

Phillips, W. Hewitt. *Journey in Aeronautical Research: A Career at NASA Langley Research Center.* Monographs in Aerospace History, No. 12, 1998.

Braslow, Albert L. *A History of Suction-Type Laminar-Flow Control with Emphasis on Flight Research.* Monographs in Aerospace History, No. 13, 1999.

Logsdon, John M., moderator. *Managing the Moon Program: Lessons Learned from Apollo*. Monographs in Aerospace History, No. 14, 1999.

Perminov, V. G. *The Difficult Road to Mars: A Brief History of Mars Exploration in the Soviet Union*. Monographs in Aerospace History, No. 15, 1999.

Tucker, Tom. *Touchdown: The Development of Propulsion Controlled Aircraft at NASA Dryden*. Monographs in Aerospace History, No. 16, 1999.

Maisel, Martin, Demo J. Giulanetti, and Daniel C. Dugan. *The History of the XV-15 Tilt Rotor Research Aircraft: From Concept to Flight*. Monographs in Aerospace History, No. 17, 2000. NASA SP-2000-4517.

Jenkins, Dennis R. *Hypersonics Before the Shuttle: A Concise History of the X-15 Research Airplane*. Monographs in Aerospace History, No. 18, 2000. NASA SP-2000-4518.

Chambers, Joseph R. *Partners in Freedom: Contributions of the Langley Research Center to U.S. Military Aircraft of the 1990s*. Monographs in Aerospace History, No. 19, 2000. NASA SP-2000-4519.

Waltman, Gene L. *Black Magic and Gremlins: Analog Flight Simulations at NASA's Flight Research Center*. Monographs in Aerospace History, No. 20, 2000. NASA SP-2000-4520.

Portree, David S. F. *Humans to Mars: Fifty Years of Mission Planning, 1950–2000*. Monographs in Aerospace History, No. 21, 2001. NASA SP-2001-4521.

Thompson, Milton O., with J. D. Hunley. *Flight Research: Problems Encountered and What They Should Teach Us*. Monographs in Aerospace History, No. 22, 2001. NASA SP-2001-4522.

Tucker, Tom. *The Eclipse Project*. Monographs in Aerospace History, No. 23, 2001. NASA SP-2001-4523.

Siddiqi, Asif A. *Deep Space Chronicle: A Chronology of Deep Space and Planetary Probes, 1958–2000*. Monographs in Aerospace History, No. 24, 2002. NASA SP-2002-4524.

Merlin, Peter W. *Mach 3+: NASA/USAF YF-12 Flight Research, 1969–1979*. Monographs in Aerospace History, No. 25, 2001. NASA SP-2001-4525.

Anderson, Seth B. *Memoirs of an Aeronautical Engineer: Flight Tests at Ames Research Center: 1940–1970*. Monographs in Aerospace History, No. 26, 2002. NASA SP-2002-4526.

Renstrom, Arthur G. *Wilbur and Orville Wright: A Bibliography Commemorating the One-Hundredth Anniversary of the First Powered Flight on December 17, 1903*. Monographs in Aerospace History, No. 27, 2002. NASA SP-2002-4527.

No monograph 28.

Chambers, Joseph R. *Concept to Reality: Contributions of the NASA Langley Research Center to U.S. Civil Aircraft of the 1990s*. Monographs in Aerospace History, No. 29, 2003. NASA SP-2003-4529.

Peebles, Curtis, ed. *The Spoken Word: Recollections of Dryden History, The Early Years*. Monographs in Aerospace History, No. 30, 2003. NASA SP-2003-4530.

Jenkins, Dennis R., Tony Landis, and Jay Miller. *American X-Vehicles: An Inventory—X-1 to X-50*. Monographs in Aerospace History, No. 31, 2003. NASA SP-2003-4531.

Renstrom, Arthur G. *Wilbur and Orville Wright: A Chronology Commemorating the One-Hundredth Anniversary of the First Powered Flight on December 17, 1903*. Monographs in Aerospace History, No. 32, 2003. NASA SP-2003-4532.

Bowles, Mark D., and Robert S. Arrighi. *NASA's Nuclear Frontier: The Plum Brook Research Reactor*. Monographs in Aerospace History, No. 33, 2004. NASA SP-2004-4533.

Wallace, Lane, and Christian Gelzer. *Nose Up: High Angle-of-Attack and Thrust Vectoring Research at NASA Dryden, 1979–2001*. Monographs in Aerospace History, No. 34, 2009. NASA SP-2009-4534.

Matranga, Gene J., C. Wayne Ottinger, Calvin R. Jarvis, and D. Christian Gelzer. *Unconventional, Contrary, and Ugly: The Lunar Landing Research Vehicle*. Monographs in Aerospace History, No. 35, 2006. NASA SP-2004-4535.

McCurdy, Howard E. *Low-Cost Innovation in Spaceflight: The History of the Near Earth Asteroid Rendezvous (NEAR) Mission*. Monographs in Aerospace History, No. 36, 2005. NASA SP-2005-4536.

Seamans, Robert C., Jr. *Project Apollo: The Tough Decisions*. Monographs in Aerospace History, No. 37, 2005. NASA SP-2005-4537.

Lambright, W. Henry. *NASA and the Environment: The Case of Ozone Depletion*. Monographs in Aerospace History, No. 38, 2005. NASA SP-2005-4538.

Chambers, Joseph R. *Innovation in Flight: Research of the NASA Langley Research Center on Revolutionary Advanced Concepts for Aeronautics*. Monographs in Aerospace History, No. 39, 2005. NASA SP-2005-4539.

Phillips, W. Hewitt. *Journey into Space Research: Continuation of a Career at NASA Langley Research Center*. Monographs in Aerospace History, No. 40, 2005. NASA SP-2005-4540.

Rumerman, Judy A., Chris Gamble, and Gabriel Okolski, comps. *U.S. Human Spaceflight: A Record of Achievement, 1961–2006*. Monographs in Aerospace History, No. 41, 2007. NASA SP-2007-4541.

Peebles, Curtis. *The Spoken Word: Recollections of Dryden History Beyond the Sky*. Monographs in Aerospace History, No. 42, 2011. NASA SP-2011-4542.

Dick, Steven J., Stephen J. Garber, and Jane H. Odom. *Research in NASA History*. Monographs in Aerospace History, No. 43, 2009. NASA SP-2009-4543.

Merlin, Peter W. *Ikhana: Unmanned Aircraft System Western States Fire Missions*. Monographs in Aerospace History, No. 44, 2009. NASA SP-2009-4544.

Fisher, Steven C., and Shamim A. Rahman. *Remembering the Giants: Apollo Rocket Propulsion Development*. Monographs in Aerospace History, No. 45, 2009. NASA SP-2009-4545.

Gelzer, Christian. *Fairing Well: From Shoebox to Bat Truck and Beyond, Aerodynamic Truck Research at NASA's Dryden Flight Research Center*. Monographs in Aerospace History, No. 46, 2011. NASA SP-2011-4546.

Electronic Media, NASA SP-4600:

Remembering Apollo 11: The 30th Anniversary Data Archive CD-ROM. NASA SP-4601, 1999.

Remembering Apollo 11: The 35th Anniversary Data Archive CD-ROM. NASA SP-2004-4601, 2004. This is an update of the 1999 edition.

The Mission Transcript Collection: U.S. Human Spaceflight Missions from Mercury Redstone 3 to Apollo 17. NASA SP-2000-4602, 2001.

Shuttle-Mir: The United States and Russia Share History's Highest Stage. NASA SP-2001-4603, 2002.

U.S. Centennial of Flight Commission Presents Born of Dreams—Inspired by Freedom. NASA SP-2004-4604, 2004.

Of Ashes and Atoms: A Documentary on the NASA Plum Brook Reactor Facility. NASA SP-2005-4605, 2005.

Taming Liquid Hydrogen: The Centaur Upper Stage Rocket Interactive CD-ROM. NASA SP-2004-4606, 2004.

Fueling Space Exploration: The History of NASA's Rocket Engine Test Facility DVD. NASA SP-2005-4607, 2005.

Altitude Wind Tunnel at NASA Glenn Research Center: An Interactive History CD-ROM. NASA SP-2008-4608, 2008.

A Tunnel Through Time: The History of NASA's Altitude Wind Tunnel. NASA SP-2010-4609, 2010.

Conference Proceedings, NASA SP-4700:

Dick, Steven J., and Keith Cowing, eds. *Risk and Exploration: Earth, Sea and the Stars.* NASA SP-2005-4701, 2005.

Dick, Steven J., and Roger D. Launius. *Critical Issues in the History of Spaceflight.* NASA SP-2006-4702, 2006.

Dick, Steven J., ed. *Remembering the Space Age: Proceedings of the 50th Anniversary Conference.* NASA SP-2008-4703, 2008.

Dick, Steven J., ed. *NASA's First 50 Years: Historical Perspectives.* NASA SP-2010-4704, 2010.

Societal Impact, NASA SP-4800:

Dick, Steven J., and Roger D. Launius. *Societal Impact of Spaceflight.* NASA SP-2007-4801, 2007.

Dick, Steven J., and Mark L. Lupisella. *Cosmos and Culture: Cultural Evolution in a Cosmic Context.* NASA SP-2009-4802, 2009.